



































Bauanleitung
Assembly instruction
Instructions de montage
Bouwhandleiding
Instrucciones de construcción

Manual de montagem
Istruzioni di montaggio
Инструкции по строительству
建筑说明

ADVANCED Crane

	31 027 1 x		208 233 7 x		208 439 3 x		213 388 4 x
	35 063 1 x		208 234 1 x		208 443 1 x		213 433 2 x
	35 070 1 x		208 235 2 x		208 445 1 x		213 434 1 x
	35 088 1 x		208 236 5 x		208 446 1 x		213 437 3 x
	36 819 1 x		208 238 5 x		208 479 2 x		213 438 2 x
	38 258 2 x		208 241 3 x		208 480 6 x		213 439 3 x
	172 541 1 x		208 244 2 x		208 481 6 x		215 108 1 x
	203 654 1 x		208 429 7 x		208 950 6 x		
	208 227 4 x		208 436 1 x		209 467 1 x		

- Alle Einzelteile, insbesondere bewegliche Teile sind falls notwendig zu warten und zu reinigen.
- All components, especially moving parts, should be maintained and cleaned as necessary.
- Toutes les pièces détachées et en particulier les pièces mobiles, sont, si nécessaire, à entretenir et à nettoyer.
- Alle onderdelen, vooral de bewegende delen, kunnen, indien noodzakelijk, onderhouden en gereinigd worden.

- Es necesario mantener limpio y en buen estado cada una de las piezas. Particularmente las piezas móviles.
- Todas as peças individuais, especialmente peças móveis, devem ser submetidas à manutenção e limpas se necessário.
- Se necessario, tutti i singoli componenti, soprattutto le parti mobili, si devono eventualmente sottoporre a manutenzione e pulizia.
- Все детали, особенно подвижные, требуют ухода и чистки.
- 必要时应保养和清洁所有零件，尤指运动部件。

- 1 7.5° 4x
- 4x
- 4x
- 4x
- fischer technik 1x

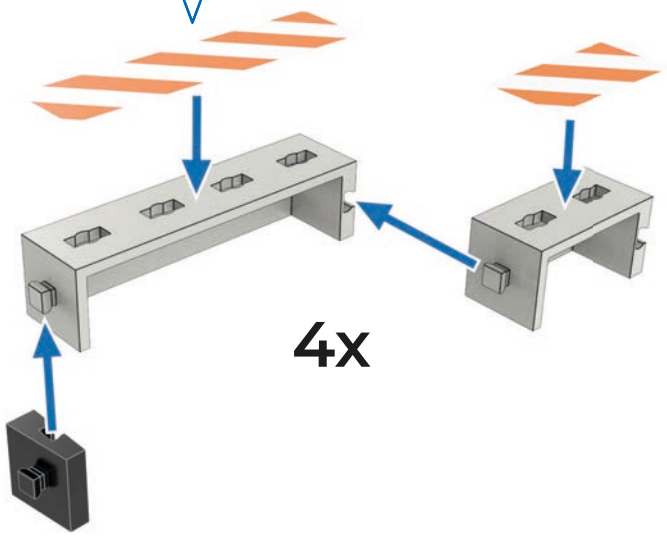

- 2
- 1x
- 1x
- 4x

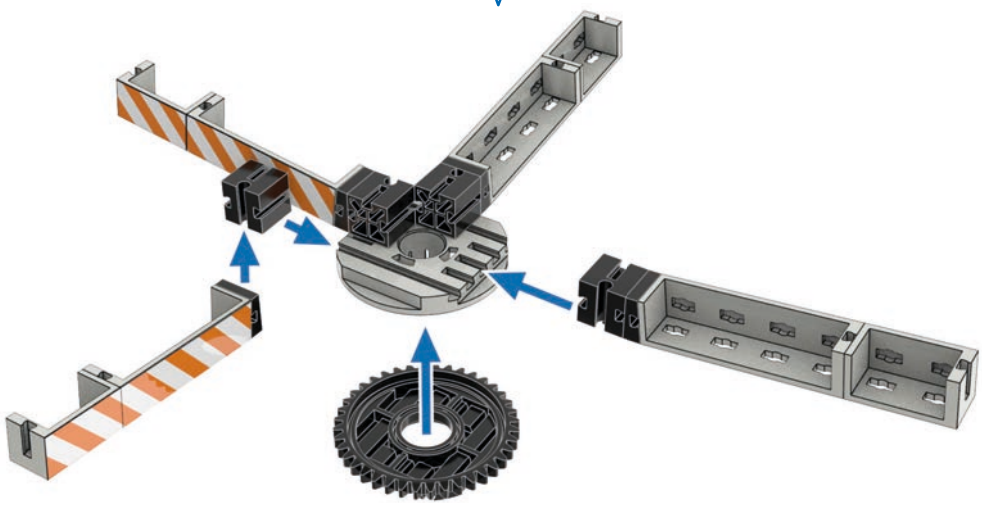

5 1x 169.6 2x 4x

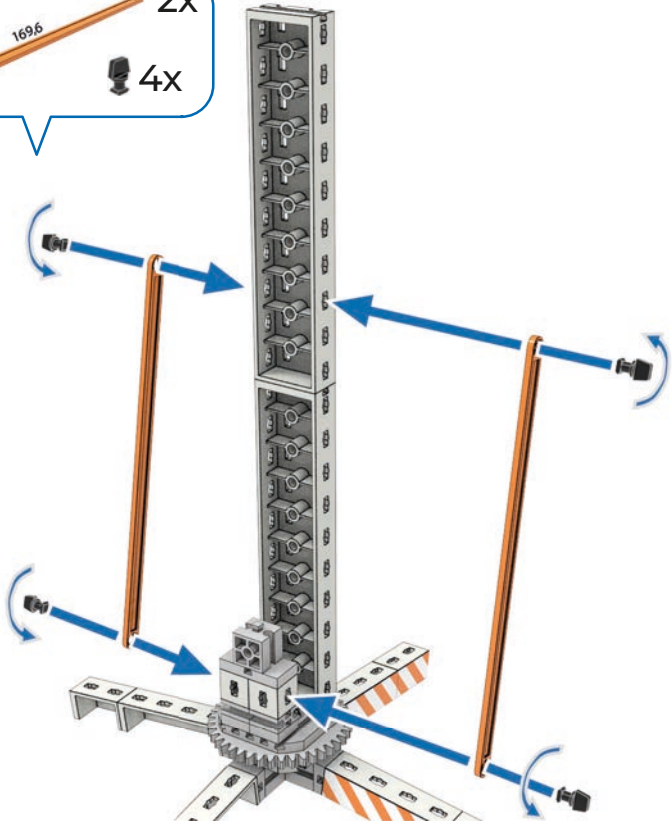

6 1x 1x 1x 1x

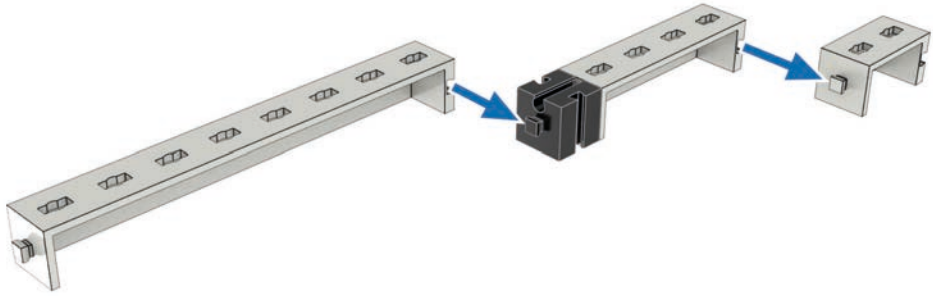

7

1x 1x 1x

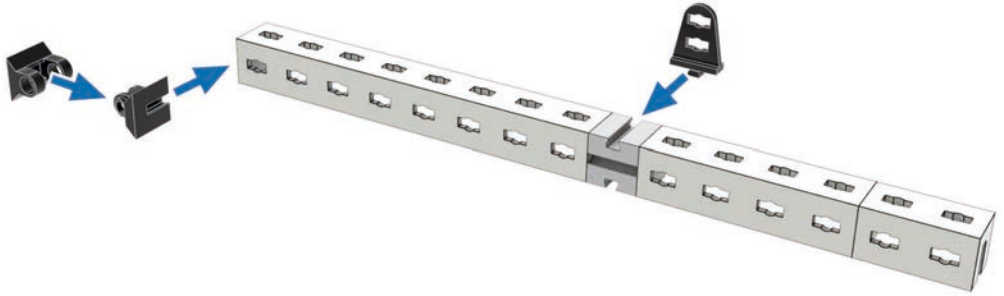

8

169.6 1x
63.6 2x
4x
1x
1x
1x 1x

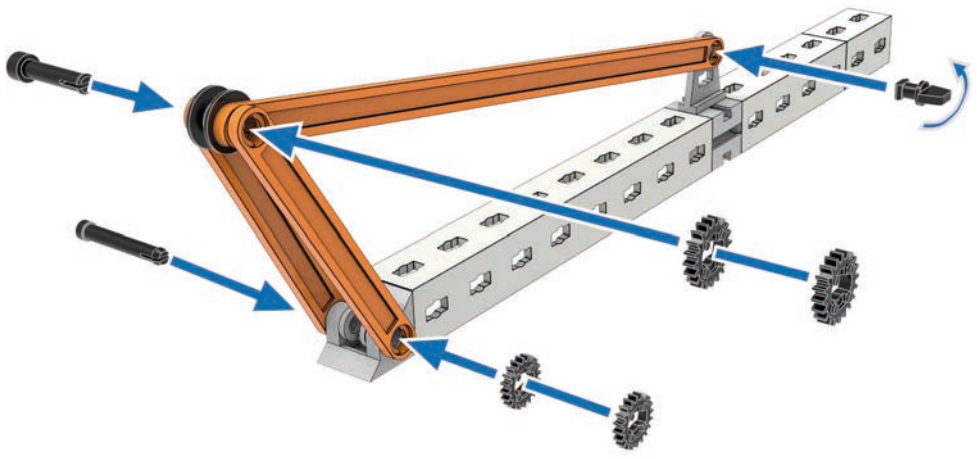

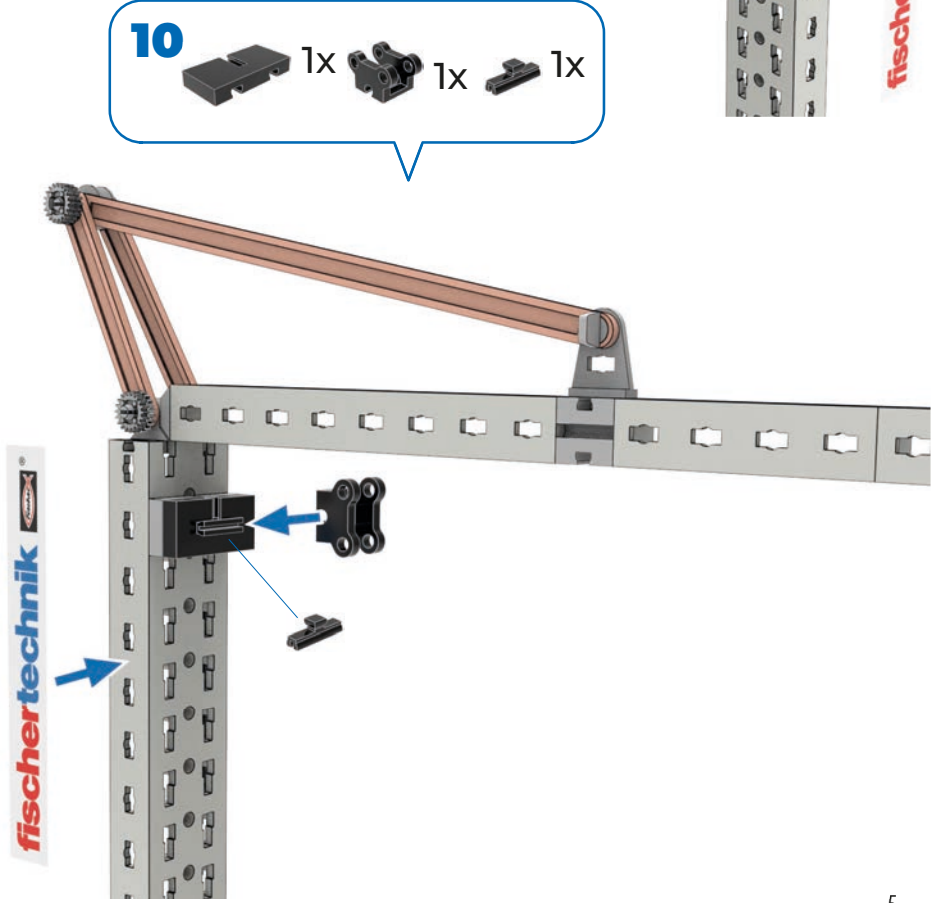
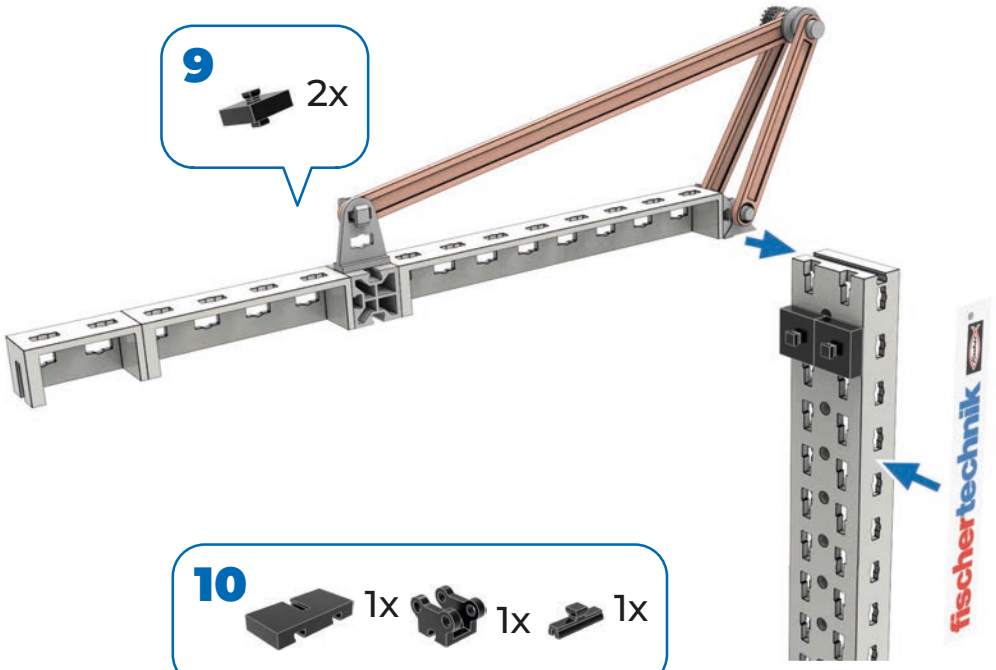

15 cm

10 cm

5 cm

0

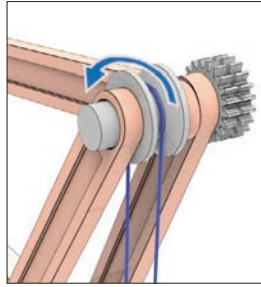

11   75 cm  1x

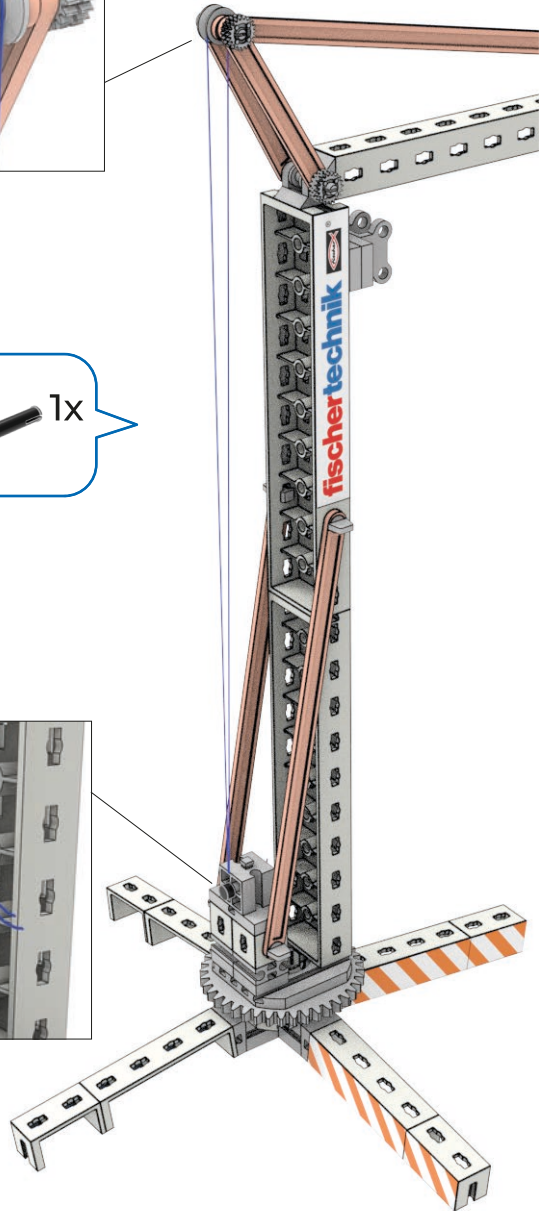
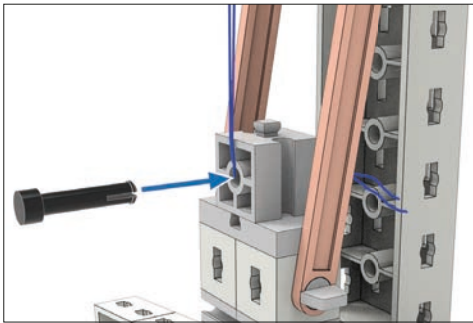

12 1x 3x
1x 2x

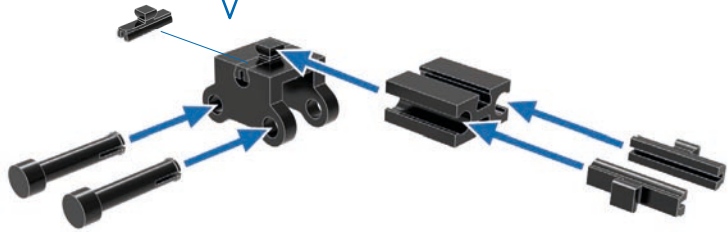

13 2x 2x



14

1x 1x

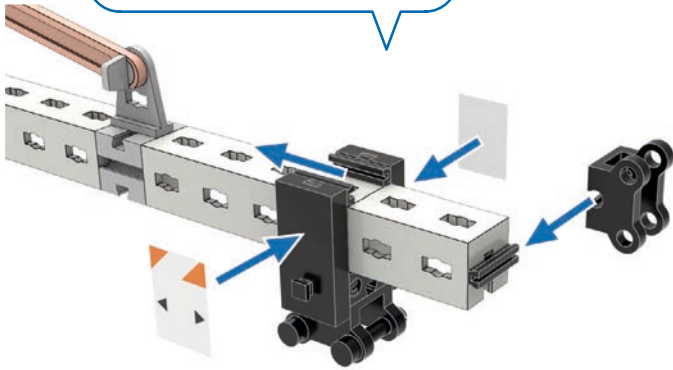

15

1x 1x 1x
1x 2x 1x

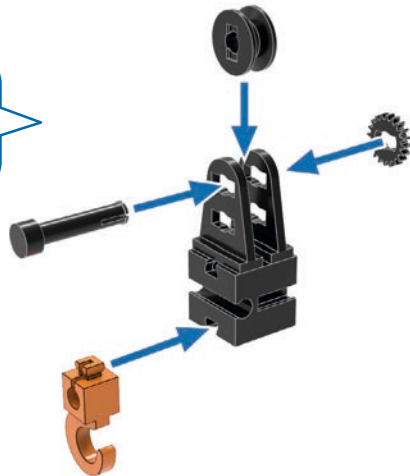

- 16**
- 30 1x
 - 1x
 - 1x
 - 1x
 - 2x
 - 1x
 - 1x

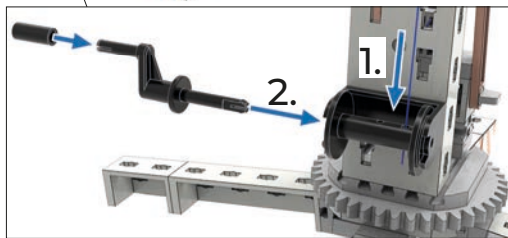
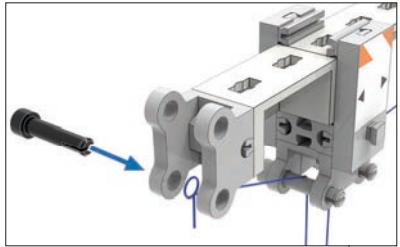
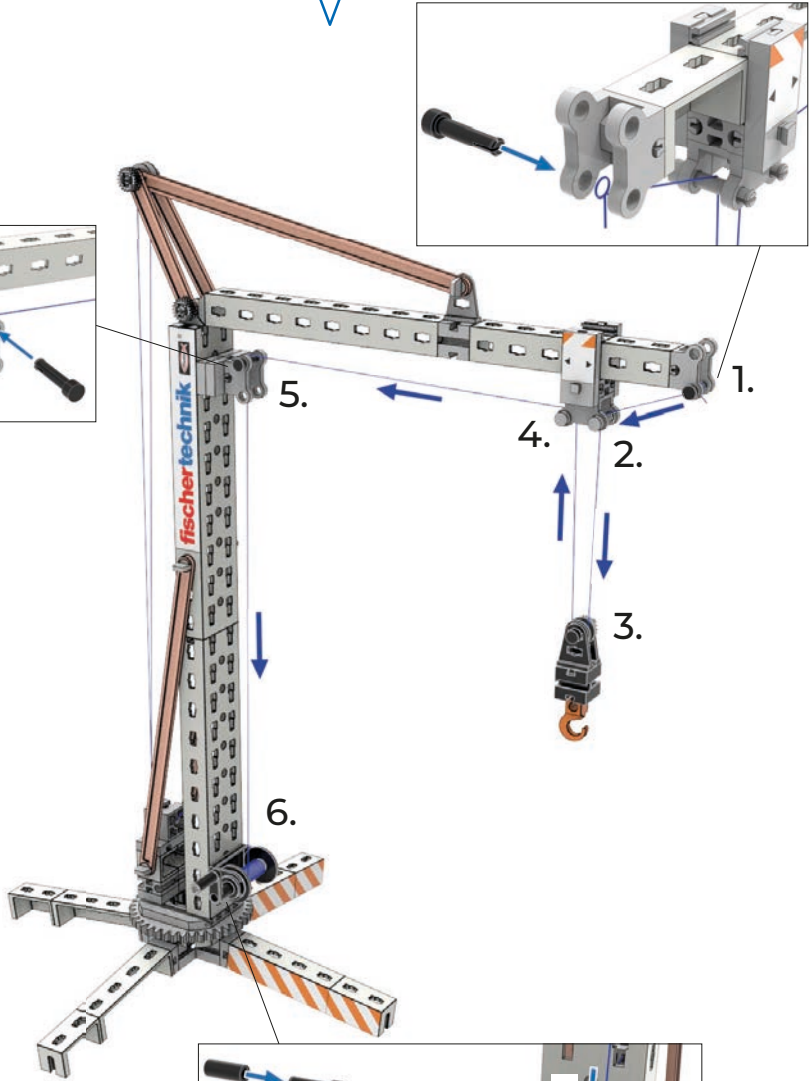
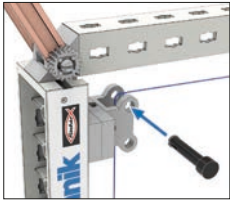

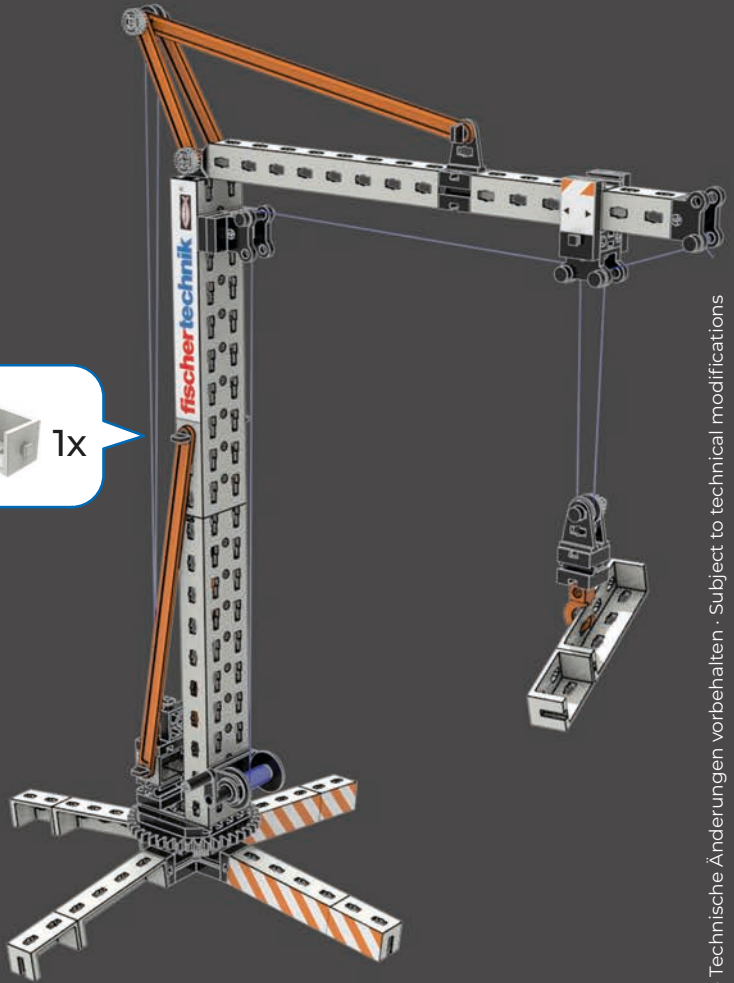

17



fischertechnik GmbH
Klaus-Fischer-Str. 1
72178 Waldachtal
Germany

Phone: +497443/12-4369
Fax: +497443/12-4591
Fax: +497443/12-4591

info@fischertechnik.de
www.fischertechnik.de



www.fischertechnik.de/FanClub

www.fischertechnik.de