

# fischer

## FIS RC II

## FIS RC II Low Speed



**DE** Gebrauchsanweisung · **EN** Operating instructions · **FR** Mode d'emploi ·  
**NL** Montagehandleiding · **IT** Istruzioni per l'installazione · **ES** Instrucciones de uso ·  
**PT** Instruções de utilização · **DA** Installationsvejledning · **SV** Installationsinstruk-  
tioner · **NO** Installasjonsveiledning · **FI** Asennusohjeet · **IS** Notkunarleiðbeiningar ·  
**ET** Kasutusjuhend · **LV** Lietošanas instrukcija · **LT** Naudojimo instrukcija ·  
**PL** Instrukcja instalacji · **CS** Návod k instalaci · **SK** Návod na používanie ·  
**HU** Szerelési útmutató · **RO** Instrucțiuni de utilizare · **SL** Navodila za namestitev ·  
**HR** Upute za instalaciju · **SR** Uputstvo za instalaciju · **TR** Kurulum talimatları ·  
**EL** Οδηγίες Εγκατάστασης · **BG** Инструкции за инсталиране · **RU** Инструкция по  
установке · **UK** Інструкція з використання · **KK** Колдану нұсқаулығы · **ZH** 使用说明书 ·  
**JA** 取扱説明書 · **KO** 사용 설명서 · **ID** Panduan Penggunaan · **AR** تعليمات الاستخدام

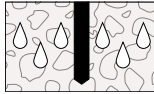

DE	Trockener Beton	Nasser Beton	Gerissener Beton	Ungerissener Beton
EN	Dry concrete	Water saturated concrete	Cracked concrete	Non-cracked concrete
FR	Béton sec	Béton humide	Béton fissuré	Béton non fissuré
NL	Droog beton	Met water verzadigd beton	Gescheurd beton	Ongescheurd beton
IT	Calcestruzzo secco	Calcestruzzo saturo d'acqua	Calcestruzzo fessurato	Calcestruzzo non fessurato
ES	Hormigón seco	Hormigón saturado de agua	Hormigón agrietado	Hormigón sin grietas
PT	Betão seco	Betão saturado de água	Betão fissurado	Betão não fissurado
DA	Tør beton	Vandmættet beton	Revnet beton	Ikkerevet beton
SV	Torr betong	Vattenmättad betong	Sprucken betong	Ej sprucken betong
NO	Torr betong	Vannmettet betong	Betong med riss	Betong uten riss
FI	Kuiva betony	Veden kyllästämä betoni	Haljennut betoni	Halkeamaton betoni
IS	þurr steinsteypa	Blaut steinsteypa	Sprungin steypa	Ógrotin steinsteypa
ET	Kuivbetoon	Märgbetoon	Pragunenud betoon	Pragudeta betoon
LV	Sausš betons	Mitrš betons	Betons ar plaisām	Betons bez plaisām
LT	Sausas betonas	Drėgnas betonas	Sutrūkinėjęs betonas	Vientisas betonas
PL	Beton suchy wodą	Beton nasycony wodą	Beton spękany	Beton niespękany
CS	Suchý beton	Mokrý beton	Beton s trhlinami	Beton bez trhlin
SK	Suchý betón	Vodou nasýtený betón	Betón s trhlinami	Betón bez trhlin
HU	Száraz beton	Nedves beton	Repedésses beton	Repedésmentes beton
RO	Beton uscat	Beton ud	Beton fisurat	Beton fără fisuri
SL	Suh beton	Moker beton	Razpokan beton	Nerazpokan beton
HR	Suhi beton	Mokri beton	Ispucani beton	Neispucani beton
SR	Suv beton	Mokar beton	Ispucao beton	Neispucao beton
TR	Kuru beton	Yaş beton	Çatlamaş beton	Çatlamaş beton
EL	Στεγνό μπετόν	Υγρό μπετόν	Μπετόν με ρωγμές	Μπετόν χωρίς ρωγμές
BG	Сух бетон	Мокър бетон	Напукан бетон	Ненапукан бетон
RU	Сухой бетон	Водонасыщенный бетон	Треснутый бетон	Цельный бетон
UK	Сухий бетон	Водонасичений бетон	Триснутий бетон	Бетон у зоні стиснення
KK	Күрпак бетон	Ылгалды бетон	Жарыктары бар бетон	Бүтін бетон
ZH	干燥混凝土	湿混凝土	有裂缝的混凝土	无裂缝的混凝土
JA	いたベトン	湿ったベトン	ひび割れがあるベトン	ひび割れのないベトン
KO	건조 콘크리트	습윤 콘크리트	균열 콘크리트	비균열 콘크리트
ID	Beton kering	Beton basah	Beton retak	Beton tidak licin
AR	خرسانة جافة	خرسانة رطبة	خرسانة متصدعة	خرسانة غير متصدعة

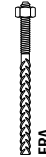

DE	Bewehrungsanschluss	Bewehrungsstab	Bewehrungsanker
EN	Reinforcement connection	Reinforcement rod	Reinforcement anchor
FR	Scellement d'armatures	Barres d'armatures	Ancrage d'armature
NL	Wapeningsaansluiting	Wapeningsstaaf	Wapeningsanker
IT	Ferri di ripresa	Ferri di ripresa	Ancoraggio di ripresa
ES	Conexión de refuerzo	Barra de refuerzo	Anclaje de refuerzo
PT	Conetor de reforço	Barra de armação	Ancoragem de reforço
DA	Armeringstilslutninger	Armeringsstav	Armeringsanker
SV	Armeringsanslutning	Armeringsjärm	Armeringsankare
NO	Armeringsforbindelse	Wapeningsstaaf	Wapeningsanker
FI	Vahvistusliittäjä	Tartuntateräs	Tartuntaankkuri
IS	Tenging við styrkingu	Styrktarteinn	Styrktarfesting
ET	Sarrusühendus	Sarrusvarras	Sarrusankur
LV	Stieģrojuma savienojums	Enkura stieģrojuma	Enkura stienis
LT	Armaturės sujungimo elementas	Armatūrinis strypas	Armatūrinis inkaras
PL	Złącze zbrojarskie	Pręt zbrojarski	Kotwa zbrojarska
CS	Připojka výtuzě	Výtuzná tyč	Kotva výtuzě
SK	Styková výstuž	Výstužný prút	Vystužovacia kotva
HU	Betonvasalatsatlakozás	Betonvas rúd	Horgonyzó vas
RO	Racord de armătură	Tijă de armătură	Ancoră de armătură
SL	Priključek za armaturo	Armaturna palica	Sidro armature
HR	Priključak armature	Armaturna šipka	Armaturno sidro
SR	Priključak armature	Armaturna šipka	Armaturna kotva
TR	Destek bağlantısı	Takviye çubuğu	Takviye demiri
EL	Σύνδεση οπλισμού	Ρόβδος οπλισμού	Αγκύριο οπλισμού
BG	Връзка за армировка	Армировъчен прът	Армировъчен анкерен болт
RU	Соединитель армирования	Арматурный стержень	Арматурный анкер
UK	Арматурне пруття	Арматурний стрижень	Арматурний анкер
KK	Арматуралау қосылымы	Арматуралық өзек	Арматуралық анкері
ZH	钢筋连接件	钢筋	钢筋锚杆
JA	強化コネクタ	鉄筋	強化アンカー
KO	보강재 연결	보강 로드	보강 앵커
ID	Sambungan penguat	Batang penguat	Jangkar penguat
AR	وصلة حديد مسلح	قضيب حد مسلح	تثبيت حديد مسلح

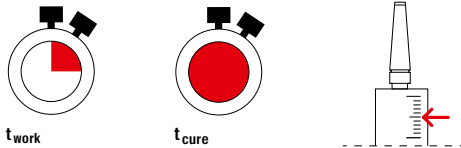

DE	Verarbeitungszeit	Aushärzeit	Skalenteile
EN	Open time	Hardening time	Scale divisions
FR	Temps de manipulation	Temps de durcissement	Graduations
NL	Verwerkingstijd	Uithardtijd	Schaalonderdelen
IT	Tempo di lavorazione	Tempo di indurimento	Divisioni di scala
ES	Tiempo de tratamiento	Tiempo de endurecimiento	Unidades de escala
PT	Tempo de processamento	Tempo de endurecimento	Intervalos de gradação
DA	Forarbejdsningstid	Hærdetid	Skalatrin
SV	Bearbetningstid	Hårdningstid	Skaladelar
NO	Bearbejdsesetid	Herdetid	Skaladeler
FI	Käsittelyaika	Kovettumisaika	Asteikkojaot
IS	Vinnslutími	Þornunartími	Mælikvarði
ET	Töötlemissaeg	Kõvastumisaeg	Skaala jaotused
LV	Apstrādājāmības laiks	Sacietēšanas laiks	Skalas iedaļas
LT	Darbo su medžiaga laikas	Kietėjimo laikas	Skalės padalos
PL	Czas żelowania	Czas wiązania	Podziały skali
CS	Doba zpracování	Doba vytvrzení	Díly na stupnici
SK	Doba spracovania	Doba vytvrdenia	Diely na stupnici
HU	Feldolgozási idő	Kikeményedési idő	Skálarészértékek
RO	Timp de punere in operă	Timp de întărire	Diviziuni scală
SL	Čas obdelave	Čas strjevanja	Razdelki na skali
HR	Vrijeme obrade	Vrijeme stvrđnjavanja	Dijelovi skale
SR	Vreme obrade	Vreme otvrdnjavanja	Delovi skale
TR	Kullanma süresi	Sertleşme süresi	Kadran bölümleri
EL	Χρόνος επεξεργασίας	Χρόνος σκλήρυνσης	Διαβθμίσεις κλίμακος
BG	Време за обработка	Време за втвърдяване	Части на скалата
RU	Время обработки	Время отверждения	Деление шкалы
UK	Час обробки	Час затвердіння	Поділки шкали
KK	Өңделу уакыты	Катаю уакыты	Шөкіл бөлiктерi
ZH	加工时间	硬化时间	刻度
JA	加工時間	凝固時間	目盛り分割
KO	작업 시간	경화 시간	스케일의 눈금폭
ID	Waktu pemrosesan	Waktu pengerasan	Bagian skala
AR	وقت التصنيع	وقت التصلب	أجزاء المقاييس



ETA-22/0502,  
EAD-330087-01-0601  
Post-installed rebar connection

ETA-22/0501  
EAD-330499-01-0601  
Option 1 for cracked concrete





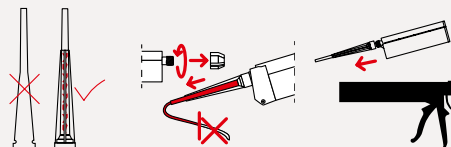
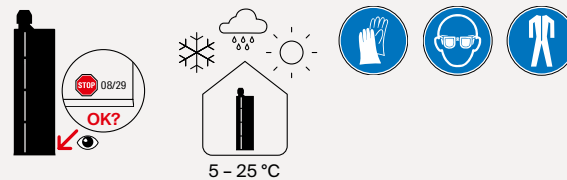

\*Informations sur le niveau d'émission de substances volatiles dans l'air intérieur, garantissant un usage de sécurité par inhalation, sur une échelle de classe allant de A+ (très basse émission) à C (forte émission).



FIS MR Plus (≤ 410 ml) /  
FIS JMR (825 ml)



#### FIS RC II / FIS RC II Low Speed

[°C]	 t <sub>work</sub> FIS RC II	 t <sub>work</sub> FIS RC II Low Speed	 t <sub>cure</sub> FIS RC II	 t <sub>cure</sub> FIS RC II Low Speed
-10 °C – -5 °C	> 20 min. <sup>1</sup>	–	> 12 h	–
> -5 °C – ± 0 °C	20 min. <sup>1</sup>	40 min.	12 h	5 d
> ± 0 °C – +5 °C	13 min. <sup>1</sup>	30 min.	3 h	48 h
> +5 °C – +10 °C	9 min. <sup>1</sup>	20 min.	90 min.	24 h
> +10 °C – +20 °C	5 min.	13 min.	60 min.	120 min.
> +20 °C – +30 °C	4 min.	9 min.	45 min.	60 min.
> +30 °C – +40 °C	2 min. <sup>2</sup>	7 min.	35 min.	45 min.

<sup>1</sup> [°C] < 10 °C ↑  ≥ 15 °C



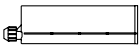
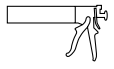

<sup>2</sup> [°C] > 30 °C ↓  ≤ 20 °C

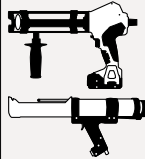
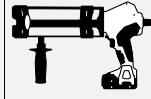
**FIS RC II / FIS RC II Low Speed**

		Art. No.		Art. No.
360 ml	FIS DM S Pro	563337	FIS MR Plus	545853
360 ml	FIS AM	058000	FIS MR Plus	545853
360 ml	FIS DB S Pro	558955 (EU)	FIS MR Plus	545853
360 ml	FIS DB S Pro	564960 (UK)	FIS MR Plus	545853
825 ml	FIS AM S-XL	563241	FIS JMR	567522
825 ml	FIS DB SL Pro	562004 (EU)	FIS JMR	567522
825 ml	FIS DB SL Pro	564961 (UK)	FIS JMR	567522

Rebar	FRA			
ø (mm)	thread	Cartridge size < 500 ml $l_{v,max} / l_{e,ges,max}$ (mm)	Cartridge size < 500 ml $l_{v,max} / l_{e,ges,max}$ (mm)	Cartridge size > 500 ml $l_{v,max} / l_{e,ges,max}$ (mm)
8	-	1000	1000	1800
10	-	1000	1000	1800
12	FRA M12 FRA HCR M12	1000	1200	1800
14	-	1000	1200	1800
16	FRA M16 FRA HCR M16	1000	1500	1800
18, 20, 22, 24	FRA M20 FRA HCR M20	700	1300	1800
25	-	700	1000	2000
28	-	700	700	2000
30, 32	-	700	700	$T_i, > 0\text{ °C} = 1500$ $T_i, \leq 0\text{ °C} = 2000$
40	-	700	700	1300



Rebar	FRA			Art. No.		
ø (mm)	thread	$d_0$ (mm)	$d_b$ (mm)		[mm]	[colour]
8	-	10	11	-	9	-
8	-	12	12,5	511956	9	nature
10	-	12	12,5	511956	9	nature
10	-	14	15	511956	9	blue
12	FRA M12 FRA HCR M12	14	15	511956	9	blue
12	FRA M12 FRA HCR M12	16	17	511957	9	red
14	-	18	19	511957	9 or 15	yellow
16	FRA M16 FRA HCR M16	20	21,5	511958	9 or 15	green
18	FRA M20 FRA HCR M20	25	26,5	511958	9 or 15	black
20	FRA M20 FRA HCR M20	25	26,5	511958	9 or 15	black
22	-	30	32	511959	9 or 15	grey
24	-	30	32	511959	9 or 15	grey
25	-	30	32	511959	9 or 15	grey
25	-	35	37	511959	9 or 15	brown
28	-	35	37	511959	9 or 15	brown
30	-	40	42	511960	9 or 15	red
32	-	40	42	511960	9 or 15	red
40	-	55	58	511960	15	nature

## Rebar, FRA



Rebar

FRA

## Rebar, FRA



Rebar

FRA

ETA-22/0501,  
EAD-330499-01-0601

ETA-22/0501,  
EAD-330499-01-0601

ETA-22/0502,  
EAD-330087-01-0601

	Rebar	Ø 8	Ø 10	Ø 12	Ø 14	Ø 16	Ø 18/ 20	Ø 25	Ø 28	Ø 32	Ø 40
	FRA	-	-	M12	-	M16	M20	-	-	-	-
	Rebar	●	●	●	●	●	●	●	●	●	●
	FRA	●	●	●	●	●	●	●	●	-	-
$d_0$		10/12	12/14	14/16	18	20	25	30	35	40	55
	fischer BS	Ø 12	Ø 14	Ø 16	Ø 18	Ø 20	Ø 25	Ø 35	Ø 35	Ø 40	Ø 55
$d_b$		14	16	20	20	25	27	40	40	42	58
	FRA	$d_f$	-	14	-	18	22	26	-	-	-
	FRA	$d_f$	-	18	-	22	26	32	-	-	-
$S_k$		6/8	6/10	6/10	14	14	28/22	26	42	54	128
		[ml] / 100 mm									
		3/4	3/5	3/5	7	7	14/11	13	21	27	64
		[S <sub>k</sub> ] / 100 mm									
	FRA	max T <sub>inst</sub> [Nm]	-	40	-	60	120	150	-	-	-

\* ETA-22/0502, EAD-330087-01-0601, Post-installed rebar connection  
ETA-22/0501, EAD-330499-01-0601, Option 1 for cracked concrete

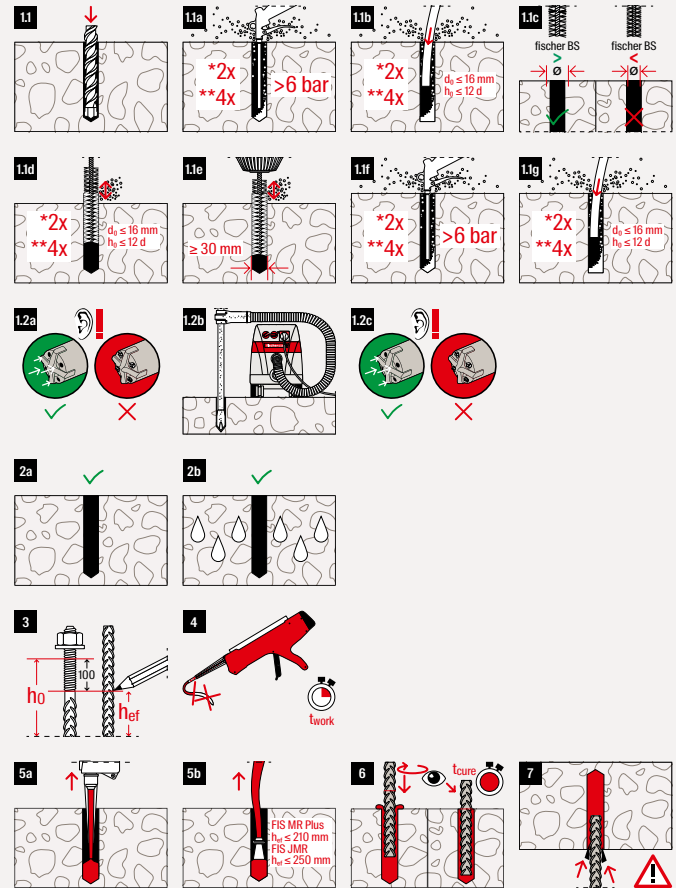

\* 2x ETA-22/0502, EAD-330087-01-0601

\*\* 4x ETA-22/0501, EAD-330499-01-0601

## Contact

### Germany

**fischer Deutschland Vertriebs GmbH**  
Klaus-Fischer-Straße 1  
72178 Waldachtal  
P +49 7443 12 - 6000  
F +49 7443 12 - 4500  
info@fischer.de  
www.fischer.de

### Argentina

**fischer Argentina s.a.**  
Colectora Este 34  
C.P. 1618 - El Talar - Buenos Aires  
P +54 1147 62 27 78  
F +54 1147 56 13 11  
asistenciaticnica@fischer.com.ar  
www.fischer.com.ar

### Austria

**fischer Austria GmbH**  
Wiener Straße 95  
2514 Traiskirchen  
P +43 2252 53730 0  
F +43 2252 53730 70  
office@fischer.at  
www.fischer.at

### Belgium

**fischer Cobemabel snc**  
Schaliñhoevedreef 20 D  
2800 Mechelen  
P +32 152 8 47 00  
F +32 152 8 47 10  
info@fischer.be  
www.fischer.be

### Brazil

**fischer brasil Industria e**  
Avenida Marginal Projetada  
1652 Galpão 15 - Barueri  
São Paulo  
P +55 11 3178 25 20  
F +55 21 2467 01 44  
fischer@fischerbrasil.com.br  
www.fischerbrasil.com.br

### China

**fischer (Taicang) fixings Co. Ltd.**  
Building 1, Suntec Industrial Park,  
No.105 North Dongcang Road  
215400 Taicang Jiangsu  
P +86 51 25 35 88 93 8  
F +86 51 25 35 88 94 8  
fich@fischer.com.cn  
www.fischer.com.cn

### Czech Republic

**fischer international s.r.o.**  
Průmyslová 1833  
25001 Brandýs nad Labem  
P +42 03 26 90 46 01  
F +42 03 26 90 46 00  
info@fischer-cz.cz  
www.fischer-cz.cz

### Denmark

**fischer a/s**  
Sandvadsvej 17 A  
4600 Køge  
P +45 46 32 02 20  
F +45 46 32 50 52  
fick@fischerdanmark.dk  
www.fischerdanmark.dk

### France

**fischer S. A. S.**  
12, rue Livio, P. O. Box 10182  
67022 Strasbourg-Cedex 1  
P +33 388 39 18 67  
F +33 388 39 80 44  
info@fischer.fr  
www.fischer.fr

### Greece

**fischer Hellas**  
Kalivront 2 & Kaifia  
14564 Kifissia, Athens  
P +30 210 283 81 67  
F +30 210 283 81 69  
info@fischer.gr  
www.fischer.gr

### Hungary

**fischer Hungária Bt.**  
Szeremi út 7/b  
1117 Budapest  
P +36 1 347 97 55  
F +36 1 347 97 66  
info@fischerhungary.hu  
www.fischerhungary.hu

### India

**fischer building material india pvt ltd.**  
Prestige Garnet Unit no- 401,  
4th floor 36, Ulsoor Road  
560042 Bangalore Karnataka  
P +91 0804 1511 991 92 93  
F +91 0804 1511 999  
info@fischer.in  
www.fischer.in

### Italy

**fischer italia S.R.L.**  
Corso Stati Uniti, 25, Casella  
Postale 391  
35127 Padova Z.1. Sud  
P +39 049 8 06 31 11  
F +39 049 8 06 34 01  
serciii@fischeritalia.it  
www.fischeritalia.it

### Japan

**fischer Japan K.K.**  
3-4-15 Kudan Minami, Pronte Kudan  
Building 3rd Floor  
102-0074 Tokyo  
P +81 33 26 34 49 1  
F +81 36 27 29 93 5  
info@fischerjapan.co.jp  
www.fischerjapan.co.jp

### Korea, Republic

**fischer Korea Co., Ltd (fikir)**  
F2, (Yangjae-dong, Samnyung Building)  
55 Maeheon-ro 6-gil, Seocho-gu,  
Seoul 06770 Korea  
P +82 1544 89 55  
F +82 1544 89 03  
info@fiskerkorea.com  
www.fiskerkorea.com

### Mexico

**fischer Sistemas de Fijación, S.A. de C.V.**  
Blvd. Manuel Avila Camacho  
3130-400 C  
54020 Col. Valle Dorado,  
Tlalnepantla  
P +52 55 55 72 08 83  
F +52 55 55 72 15 90  
info@fiskermex.com.mx  
www.fiskermex.com.mx

### Norway

**fischer Norge AS**  
Oluf Onsumsvei 9  
0680 Oslo  
P +47 23 24 27 10  
F +47 23 24 27 13  
ordre@fischerfinland.no  
www.fischer norge.no

### Philippines

**fischer PH Asia, Inc. (fiph)**  
24F Quadrant 2, The Upper Class  
Tower, Quezon Ave. cor Scout Reyes  
St., Paliglahan,  
1103 Quezon City, Philippines  
P +63 2836 25102  
F +63 2880 3256  
sales@fischerph.com  
www.fischerph.com

### Poland

**fischerpolska Sp. z o.o**  
ul. Albatrosow 2  
30-716 Kraków  
P +48 12 2 90 08 80  
F +48 12 2 90 08 88  
info@fischerpolska.pl  
www.fischerpolska.pl

### Portugal

**fischerwerke Portugal, Lda.**  
Rua das Musas, Passeio dos Cruzados  
Lote 2.01 (Bloco3), Loja 8 (01.D) /  
Parque das Nações, 1990-171 Lisboa  
P +351 218 954 180  
F +351 218 967 066  
fischerportugal.info@fischer.pt  
www.fischer.pt

### Qatar

**fischer fasteners QD Trading LLC**  
Building No. 233, Office No. 8A,  
1st Floor, Street No. - 230,  
Zone No. 41, C Ring Road,  
Doha

### Romania

**fischer fixings Romania S.R.L.**  
Strada Oradiei, Nr. 1-3-5-7  
400220 Cluj Napoca, Judetul Cluj  
P +40 264 455 166  
F +40 264 403 060  
zoltan.kovacs@fischer.com.ro  
zoltan.kovacs@fischer.com.ro  
www.fischer.com.ro

### Russian Federation

**OOO fischer Befestigungssysteme Rus**  
Leningradskoe shosse, 47, Bldg. 2,  
2nd floor, apt. V1, 125195 Moscow  
P +7 495 223 61 62  
F +7 495 223 03 34  
Info@fischerfixing.ru  
www.fischerfixing.ru

### Singapore

**fischer systems Asia Pte. Ltd.**  
4 Kaki Bukit Avenue 1, #01-06  
417939 Singapore  
P +65 6741 0480  
F +65 6741 0481  
sales@fischer.sg  
www.fischer.sg

## Contact

### Finland

**fischer Finland Oy**  
Suomalaistentie 7 B  
02270 Espoo  
P +358 20 741 46 60  
F +358 20 741 46 69  
orders@fischerfinland.fi  
www.fischerfinland.fi

### Spain

**fischer Ibérica S.A.U.**  
Klaus Fischer 1, 43300 Mont-Roig del  
Camp, Tarragona  
P +34 977 83 87 11  
F +34 977 83 87 70  
servicio.cliente@fischer.es  
www.fischer.es

### Sweden

**fischer Sverige AB**  
Nygatan 93  
602 34 Norrköping  
P +46 11 31 44 50  
info@fischersverige.se  
www.fischersverige.se

### Netherlands

**fischer Benelux B.V.**  
Gooimeer 14  
1411 DE Naarden  
P +31 35 6 95 66 66  
F +31 35 6 95 66 99  
info@fischer.nl  
www.fischer.nl

### United Arab Emirates

**fischer FZE**  
R/A 07, BA - 04, Jebel Ali Free Zone  
Dubai  
P +97 14 8 83 74 77  
F +97 14 8 83 74 76  
enquiry@fischer.ae  
www.fischer.ae

### Türkiye

**fischer Metal Sanayi Ve Ticaret Ltd Sti**  
Cevizli Mahallesi, Mustafa Kemal  
Paşa Cad. Seyit Gazi Sok. No 66,  
Hukukcular Towers A Blok, 34865  
Kartal İstanbul  
P +90 216 326 00 66  
F +90 216 326 00 18  
info@fischer.com.tr  
www.fischer.com.tr

### Slovakia

**fischer S.K. s.r.o.**  
Nová Rožňavská 134 A  
831 04 Bratislava  
P +421 2 4920 60 46  
F +421 2 4920 60 44  
info@fischerwerke.sk  
www.fischer-sk.sk

### United States

**fischer fixings LLC (flus)**  
1087 Elm St, Manchester,  
NH 03101 Unit 408  
P +1 973 256 30 45  
F +1 845 625 26 66  
sales@fischerus.com  
www.fischerfixingsusa.com

### United Kingdom

**fischer fixings UK Ltd.**  
Whitley Road  
Oxon OX10 9AT Wallingford  
P +44 1491 82 79 00  
F +44 1491 82 79 53  
info@fischer.co.uk  
www.fischer.co.uk



**fischer stands for**

fixing Systems

fischertechnik

Consulting

Electronic Solutions

---

**fischerwerke GmbH & Co. KG**

Klaus-Fischer-Straße 1 · 72178 Waldachtal

Germany

P +49 7443 12-0

[www.fischer-international.com](http://www.fischer-international.com) · [info@fischer.de](mailto:info@fischer.de)

---