

MFWA Leipzig GmbH

Testing, Inspection and Certification Authority for
Construction Products and Construction Types

Leipzig Institute for Materials Research and Testing
Business Division III - Structural Fire Protection

Dipl.-Ing. Michael Juknat

Work Group 3.2 - Fire Behaviour of Building Components and special
Constructions

Dipl.-Ing. S. Bauer

Tel.: +49 (0) 341-6582-194

s.bauer@mfa-leipzig.de

Notice of extension of the validity of the advisory opinion no. GS 3.2/15-141-4 from 14th December 2016

19th May 2021

No. Copy 1

Subject matter: channel FLS 37/1.2
Advisory opinion on the strength and deformation behaviour of the channel FLS 37/1.2 in different constructions and as ALK 37/1.2 cantilever arm under thermal exposure.

Client: fischerwerke GmbH & Co. KG
Klaus-Fischer-Straße 1
D-72178 Waldachtal

Person in charge: Dipl.-Ing. S. Bauer

Validity: The validity of the expert opinion is unlimited and ends as soon as technical regulations change or the reference documents become invalid.

This notice extends the period of validity of the advisory opinion no. GS 3.2/15-141-4 from 14th December 2016.

This notice is only valid in conjunction with the advisory opinion no. GS 3.2/15-141-4 from 14th December 2016 and may only be used in conjunction with it.

The results of the tests exclusively relate to the items tested. This document does not replace a certificate of conformity or suitability according to national and European building codes.

Leipzig, 19th May 2021

Dipl.-Ing. M. Juknat
Head of Business Division

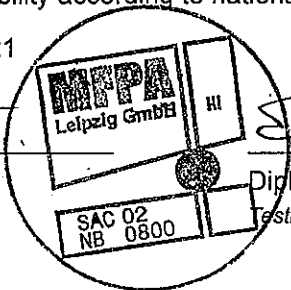

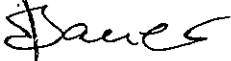
Dipl.-Ing. S. Bauer
Testing Engineer

This document may only be reproduced in its unabbreviated form. All publication, even in excerpts, requires the prior written permission of MFWA Leipzig GmbH. The legal binding form is the written German form with the original signatures and original stamp of the authorized signatory / signatories. General terms and conditions of MFWA Leipzig GmbH are valid.

Gesellschaft für Materialforschung und Prüfungsanstalt für das
Bauwesen Leipzig mbH (MFWA Leipzig GmbH)

Head Office: Hans-Weigel-Str. 2b – 04319 Leipzig/Germany
Managing Director: Dr.-Ing. habil. Jörg Schmidt
Comm. Register: Local Court Leipzig HRB 17719
VAT-ID: DE 813200649
Tel.: +49 (0) 341-6582-0
Fax: +49 (0) 341-6582-135



MFPA Leipzig GmbH

Testing, Inspection and Certification Authority for
Construction Products and Construction Types

**Leipzig Institute for Materials Research and Testing
Business Division III - Structural Fire Protection**

Dipl.-Ing. Sebastian Hauswaldt

**Work Group 3.2 - Fire Behaviour of Building Components and special
Constructions**

Dipl.-Wirtsch.-Ing. S. Kramer

Tel.: +49 (0) 341-6582-194

s.kramer@mfpa-leipzig.de

Advisory Opinion No. GS 3.2/15-141-4

14 December 2016

No. Copy 1

Translation of the original German document GS 3.2/15-141-4

Subject matter: channel FLS 37/1.2
Advisory opinion on the strength and deformation behavior of the channel FLS 37/1.2 in different constructions and as ALK 37/1.2 cantilever arm under thermal exposure.

Client: fischerwerke GmbH & Co. KG
Klaus-Fischer-Straße 1
D - 72178 Waldachtal

Date of order: 26. May 2015

Person in charge: Dipl.-Wirtsch.-Ing. Sabine Kramer

Validity: 13. December 2021

This document consists of 6 pages und 2 Enclosures.

This document may only be reproduced in its unabbreviated form. All publication, even in excerpts, requires the prior written permission of MFPA Leipzig GmbH. The legal binding form is the written German form with the original signatures and original stamp of the authorized signatory / signatories. General terms and conditions of MFPA Leipzig GmbH are valid.

Gesellschaft für Materialforschung und Prüfungsanstalt für das
Bauwesen Leipzig mbH (MFPA Leipzig GmbH)

Head Office: Hans-Weigel-Str. 2b – 04319 Leipzig/Germany
Managing Director: Prof. Dr.-Ing. Frank Dehn
Comm. Register: Local Court Leipzig HRB 17719
VAT-ID: DE 813200649
Tel.: +49 (0) 341-6582-0
Fax: +49 (0) 341-6582-135

1 Objective and request

MFPA Leipzig GmbH was commissioned on 26. May 2015 by fischerwerke GmbH & Co. KG to prepare an advisory opinion on the strength and deformation behaviour of the channel FLS 37/1.2 and cantilever arm ALK 37/1.2 under a exposure to fire according to DIN EN 1363-1: 2012-10 [1]. The characteristic values for a central tensile load and the occurring deformation behaviour in case of fire should be described when installed in a ceiling construction of reinforced concrete.

2 Description of the tested construction

The channel FLS 37/1.2 is a profiled steel profile of cold-formed, galvanised strip steel. It is mainly used to fasten pipes in conjunction with the corresponding pipe clamps or to support electrical installation conduits with a predominantly static load. The channel FLS 37/1.2 was tested in various suspension variants, as cantilever arm 37/1.2 and with different loads. A graphical presentation of the construction can be found in Enclosure 1. Further information according the tested constructions are given in the test report PB 3.2/15-141-2 [2].

3 Fire protection assessment

The permissible loads are determined on the basis of RAL-GZ 656: 2010-05 [3]. The following characteristic parameters for the load under tension can be quoted for the channel FLS 37/1.2 and cantilever arm 37/1.2 on this basis (Table 1).

Table 1 Characteristic maximum tension resistance for channel FLS 37/1.2

Channel	Span [mm]	Suspended height [mm]	Type of suspension	Load ¹⁾	Permissible maximum load as a function of the fire-resistance period			
					30	60	90	120
					Max. F [kN]			
FLS 37/1,2	400	0	GS	EL	0.24	0.13	0.10	0.09
				ML	0.72	0.38	0.30	0.27
				GL				
	400	500	GS	EL	0.47	0.38	0.33	0.30
				ML	1.42	1.13	0.99	0.90
				GL	1.37	1.19	1.06	0.95
ALK 37/1,2	400	500	GS	EL	1.33	0.78	0.53	0.40
				ML				
				GL				

¹⁾ EL = single load
ML = triple load
GL = uniform load

The graphical analysis of the test results as well as the corresponding fire-resistance period can be found in Anlage 1. *The maximum loads quoted relate to a complete failure of the relevant construction. Any serious deformations that suddenly occur beforehand are ignored.*



4 Restrictions on use

The present assessment of the channel FLS 37/1.2 and cantilever arm 37/1.2 excludes their use for cable systems with integrated functional integrity and electric conduits acc. to DIN 4102-12: 1998-11 [4]. Further assessments and proofs are needed with respect to the overall system for such applications.

The assessment is valid only, if the junctions/intersections are designed in the manner shown in the test report. The channel FLS 37/1.2 fastened directly should be arranged so that the connectors FSM Clix P8 are only used in the channel profiles that are open at the bottom. The connectors FSM Clix P8 are locked with channel washers HK 31 8.5 and MU M8 threaded nuts in this setup.

In case of suspension by threaded rods (at least M8, strength class ≥ 4.8) channel washers HK 31 8.5 have to be used on both sides with corresponding nuts (strength class ≥ 8). The channels should be arranged in this case so that the channel profiles are open at the top.

If pipe clamps or other installations are mounted below the channel they should be fastened by fischer channel washers arranged on both sides as well as the corresponding nuts and threaded rods (at least M8, strength class ≥ 4.8) of the desired fire-resistance period. If a single load is mounted on the cantilever arm according to Table 1 it has to be with threaded rods minimum M10 (strength class ≥ 4.8) and fischer channel washers HK 31 10.5 as well as nuts on both sides.

If the channel FLS 37/1.2 are used in the intermediate ceiling area of suspended counter ceiling constructions that are relevant with respect to fire protection, a minimum gap "a" is defined on the safe side between the upper side of the suspended ceiling and the lower side of the channels. The goal is to rule out any negative influence of the counter ceiling construction due to temperature-related vertical deformations of the channels as well as the linear changes of the threaded rods.

It is assumed that the maximum protrusion of the nuts and threaded rods below the channels is less than 30 mm. It also has to be ensured that both the channels as well as the suspension cantilever arms protrude at least 50 mm from the central axis of the vertical fastening to the lateral edge of the channel.

In the following figures the different installation cases are represented schematically and the minimum distances are marked.

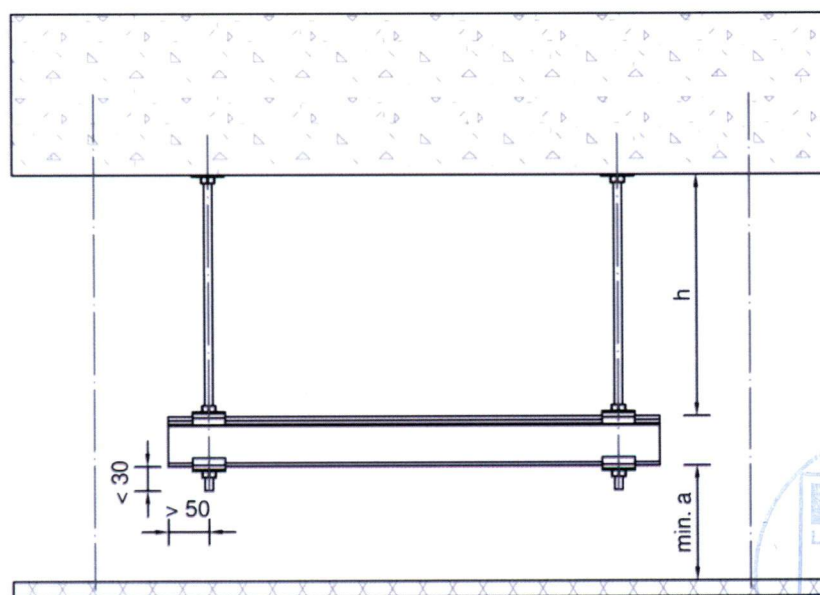

Figure 1 Illustration of use in the intermediate ceiling area – suspended with threaded rods

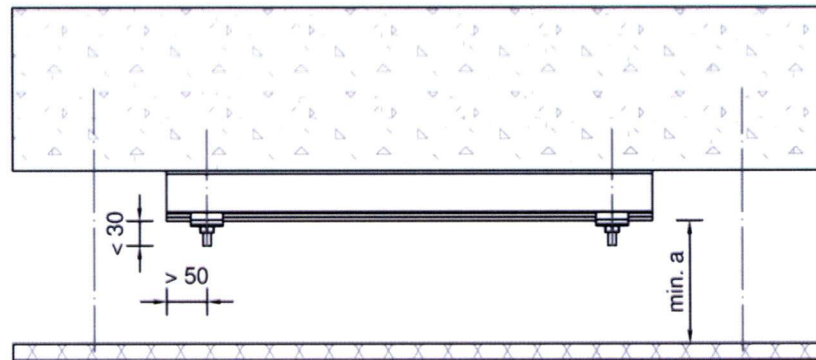

Figure 2 Illustration of use in the intermediate ceiling area – directly fastened to the ceiling

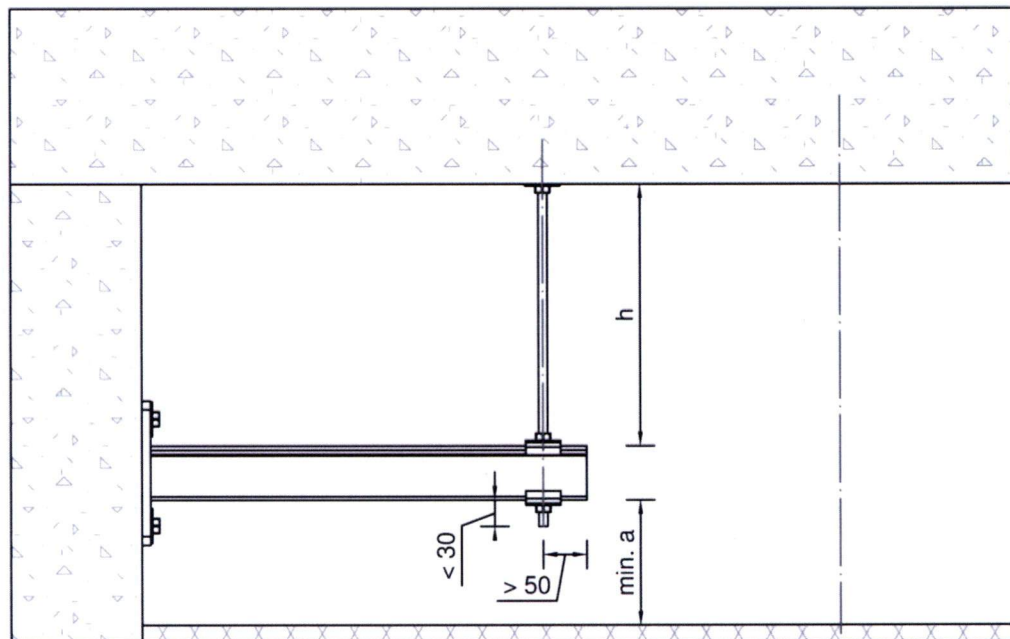

Figure 3 Illustration of use of the fischer cantilever arm ALK 37/1.2 in the intermediate ceiling area

The minimum gaps "min a" are shown in Table 2. The values shown here take into account the temperature-related change in length of the threaded rods used for suspension purposes as well as the maximum vertical deformations as a function of the span of the channels, the type of suspension and the arrangement of the load.

The minimum gaps "min a" quoted here to components below this that are relevant for fire protection correspond to the maximum safety gaps assuming that the maximum permissible loads under exposure to fire corresponding to Table 1 act on the system.

Since the useful height in the intermediate ceiling area in practice is often limited, the aforementioned maximum safety gaps may not always be able to be realised. For this reason, reduced loads are determined for the systems to be assessed which guarantee that with an exposure to fire acc. to the standard temperature-time curve for 30 minutes, the minimum gap "min a" = 50 mm acc. to MLAR [5] is not exceeded.

Table 2 Minimum gaps "min a" when the channels are used in the intermediate ceiling area of counter ceilings relevant for fire protection and maximum load for which the maximum vertical deformation of the overall construction is ≤ 50 mm according to MLAR for a fire-resistance period of 30 minutes

Channel	Span [mm]	Suspended height [mm]	Type of suspension	Load	Minimum gaps „min a“ at maximum load		Maximum load for a fire-resistance period F30 and "min a" ≤ 50 mm acc. to MLAR	
					min a	Max load	min a	Max load
FLS 37/1.2	400	0	GS	EL	93 mm	0.24 kN	50 mm	0.24 kN
				ML				0.72 kN
				GL				0.09 kN
	400	500	GS	EL	389 mm	0.47 kN		0.26 kN
				ML				1.42 kN
				GL				1.37 kN
400	500	GS	EL	226 mm	1.33 kN	0.32 kN		
			ML			0.81 kN		
			GL					

The minimum gap "min a" refers to the deformations of the overall construction consisting of channel and suspension under exposure to fire. Additional deformations, e.g. from the installations (e.g. pipes) have to be investigated separately.

The specified load refers to a central and/or symmetrical arrangement of the loads. If this is not possible in practice the loads have to be reduced so that the maximum steel stresses are not exceeded in the threaded rods.

The loads quoted in Tables 1 and 2 are summations of all single loads. This overall load may not be exceeded with a simultaneous support and suspension at one point where the load is introduced.

5 Special notes

The foregoing assessment only applies for the tested channel FLS 37/1.2 and cantilever arm ALK 37/1.2 of electrogalvanised steel that have been installed in accordance with the mounting instructions in the technical data sheets of the firm of fischerwerke GmbH & Co. KG and taking into account the design of the junctions/intersections specified in the test report.

On account of the better high-temperature behaviour of stainless steel, the figures also apply for the channel FLS 37/1.2 and cantilever arm ALK 37/1.2 with the same dimensions of stainless steel A2/A4.

The type of galvanisation has no effect on the fire resistance. This is why the figures also apply for channel FLS 37/1.2 and cantilever arm ALK 37/1.2 of hot-dip galvanised steel, provided the dimensions of the channels are identical to those of the tested channels.

The assessment only applies in conjunction with the described components and in components that can be classified in at least the fire-resistance class corresponding to the fire-resistance period of the channel constructions.

The channel systems may only be used to fasten installations (e.g. pipes) under a predominantly static load.

The channels have to be fastened to ceiling or wall constructions with fasteners that have corresponding fire protection verification. If connecting to solid structural components it has to be ensured that any loads occurring during a fire can be absorbed.

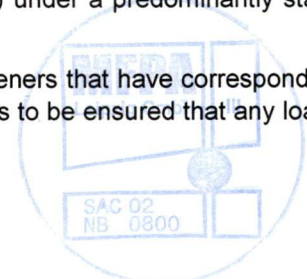



The specified loads can both be suspended from the rails and mounted on pillars. However, if mounted on pillars there is a much greater risk of a rail distortion and therefore rails mounted on pillars have to be considered separately in conjunction with the overall system.

This document does not replace a certificate of conformity or suitability according to national and European building codes.

Leipzig, 14 December 2016

Dipl.-Ing. S. Hauswaldt
Head of Business Division

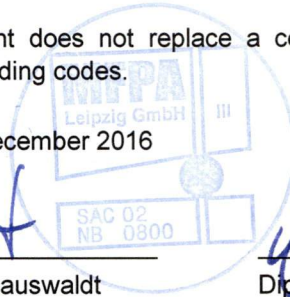

Dipl.-Ing. M. Juknat
Head of Laboratory

Dipl.-Wirtsch.-Ing. S. Kramer
Testing Engineer

Belonging documents

- [1] DIN EN 1363-1: 2012-10 *Fire resistance tests - Part 1: General Requirements*
- [2] Channel FLS 37/1.2 - Test in compliance with RAL-GZ 656 to determine strength and deformation behavior under thermal exposure with the standard temperature-time curve (ETK) according to DIN EN 1363-1 PB 3.2/15-141-2 *Test report*, MFP Leipzig GmbH: 8. Dezember 2015, fischerwerke GmbH & Co. KG
- [3] RAL-GZ 656: 2010-05 *Fire-tested Pipe Supports*
- [4] DIN 4102-12: 1998-11 *Fire behaviour of building materials and building components - Part 12: Circuit integrity maintenance of electric cable systems; requirements and testing*
- [5] Model guideline for technical fire protection requirements on conduit systems (Model Conduit Systems Guideline MLAR) MLAR: 17. November 2005

As well as:

Technical data sheets of the channel FLS 37/1.2 from the firm of Firma fischerwerke GmbH & Co. KG

List of Enclosures

- Enclosure 1 Installation parameters for the tested channel FLS 37/1.2
- Enclosure 2 Graphical analysis of the test results

Enclosure 1 Installation parameters for the tested channel FLS 37/1.2

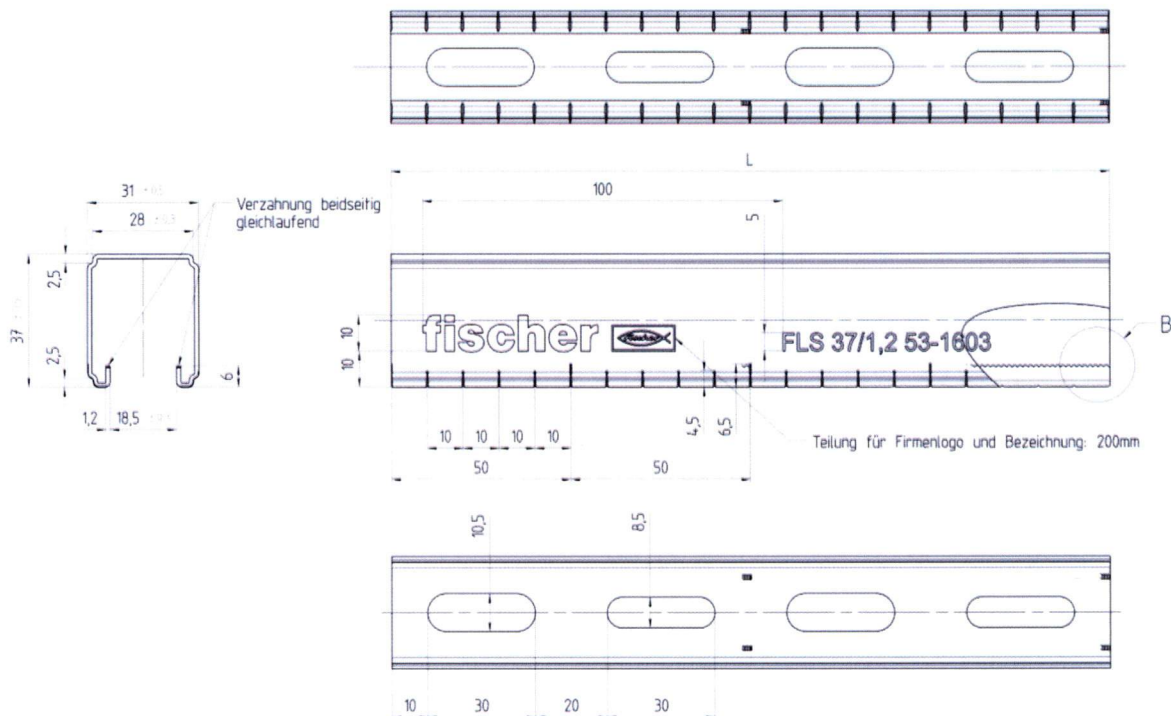

Table A1.2 Materials of the used components

Designation	Remark	Material	Strenght class
FLS 37/1.2	Channel	Steel S250 GD acc. to DIN EN 10346 (material no. 1.0242), sendzimir galvanised, approx. 20 µm	
ALK 37/1.2	Cantilever arm	Channel and base plate: Steel S235 JR acc. to DIN EN 10025 (material no. 1.0337), electrogalvanised, at least 13 µm	
HK 31 8.5	Channel washer	Steel S235 JR+CR acc. to DIN EN 10025 (material no. 1.0037), electrogalvanised, at least 5 µm	
HK 31 10.5	Channel washer	Steel S235 JR+CR acc. to DIN EN 10025 (material no. 1.0037), electrogalvanised, at least 5 µm	
FSM Clix P8	Sliding channel nut	Steel S420 MC acc. to DIN EN 10149 (material no. 1.0980), electrogalvanised, at least 5 µm Plastic: PP Polypropylen 11400 (black)	
MU M8	Hexagonal nut	Steel acc. to DIN 934, electrogalvanised, at least 3-8 µm	≥ 8
MU M10	Hexagonal nut	Steel acc. to DIN 934, electrogalvanised, at least 3-8 µm	≥ 8
U 8x40	Washer	Steel acc. to DIN 10139, electrogalvanised, at least 3 µm	
U 10x40	Washer	Steel acc. to DIN 10139, electrogalvanised, at least 3 µm	
GS 8	Threaded rod	Steel acc. to DIN 976, electrogalvanised, at least 3 µm	≥ 4.8
GS 10	Threaded rod	Steel acc. to DIN 976, electrogalvanised, at least 3 µm	≥ 4.8

Enclosure 2 Graphical analysis of the test results

Diagram A2.1 Fire-resistance curve for FLS 37/1.2, fastened directly with triple load

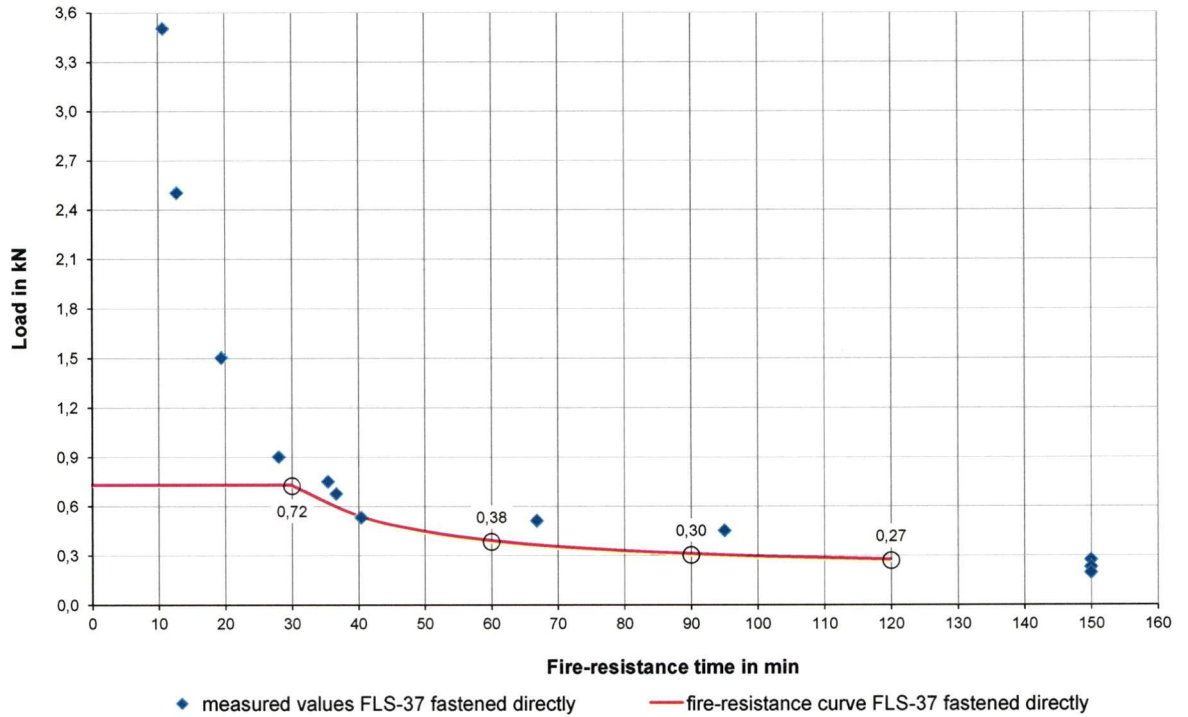

Diagram A2.2 Load-deformation curve for FLS 37/1.2, fastened directly with triple load with a fire-resistance period of 30 minutes

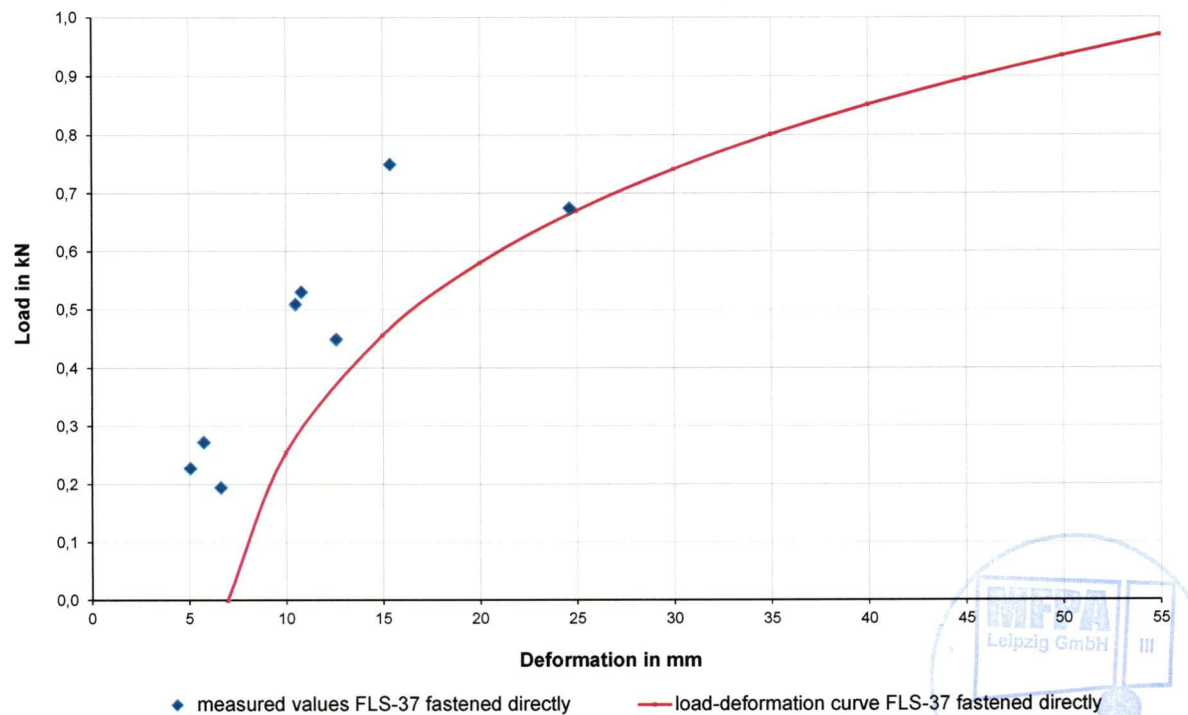

Diagram A2.3 Fire-resistance curve for FLS 37/1.2, suspended with triple load

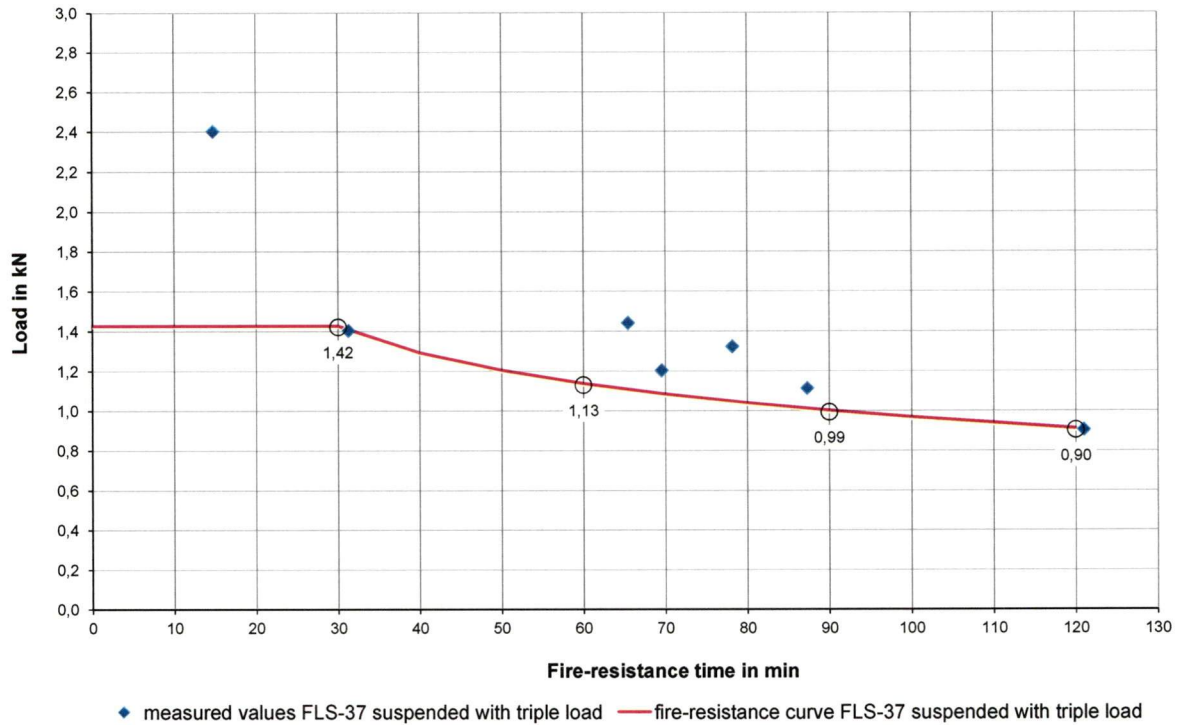

Diagram A2.4 Load-deformation curve for FLS 37/1.2, suspended with triple load with a fire-resistance period of 30 minutes

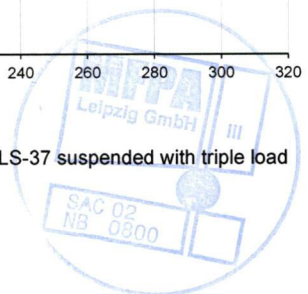
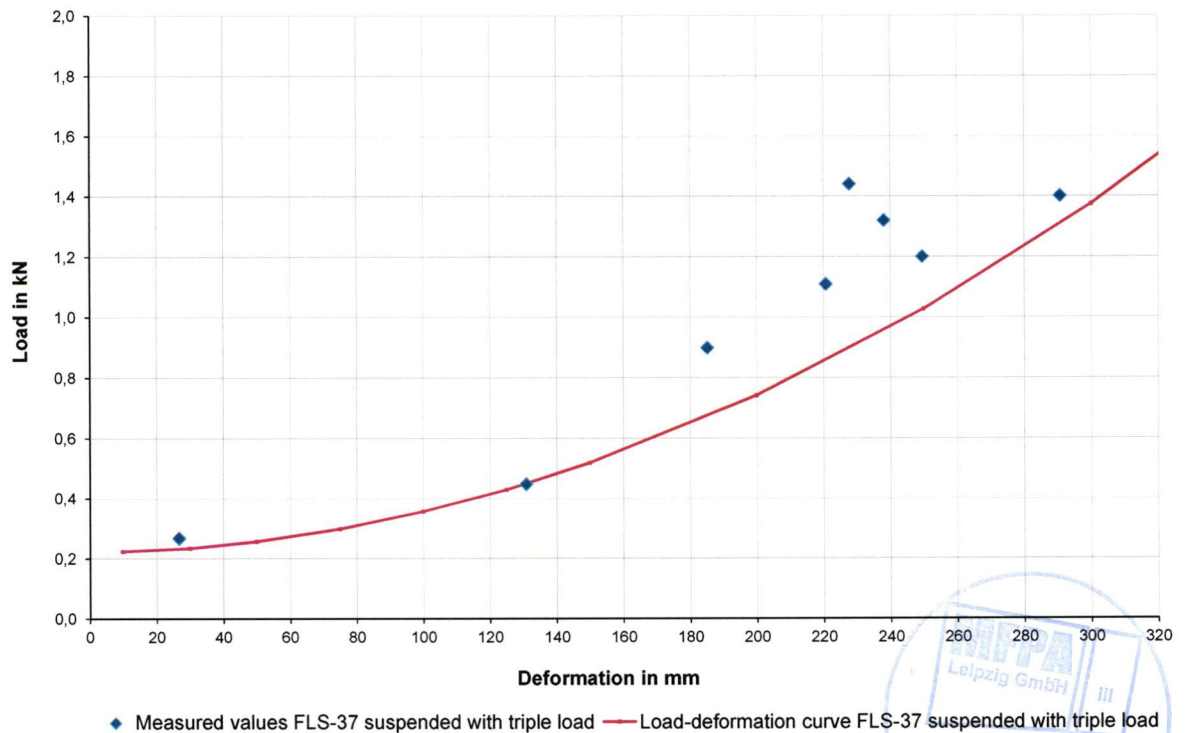

Diagram A2.5 Fire-resistance curve for FLS 37/1.2, suspended with uniform load

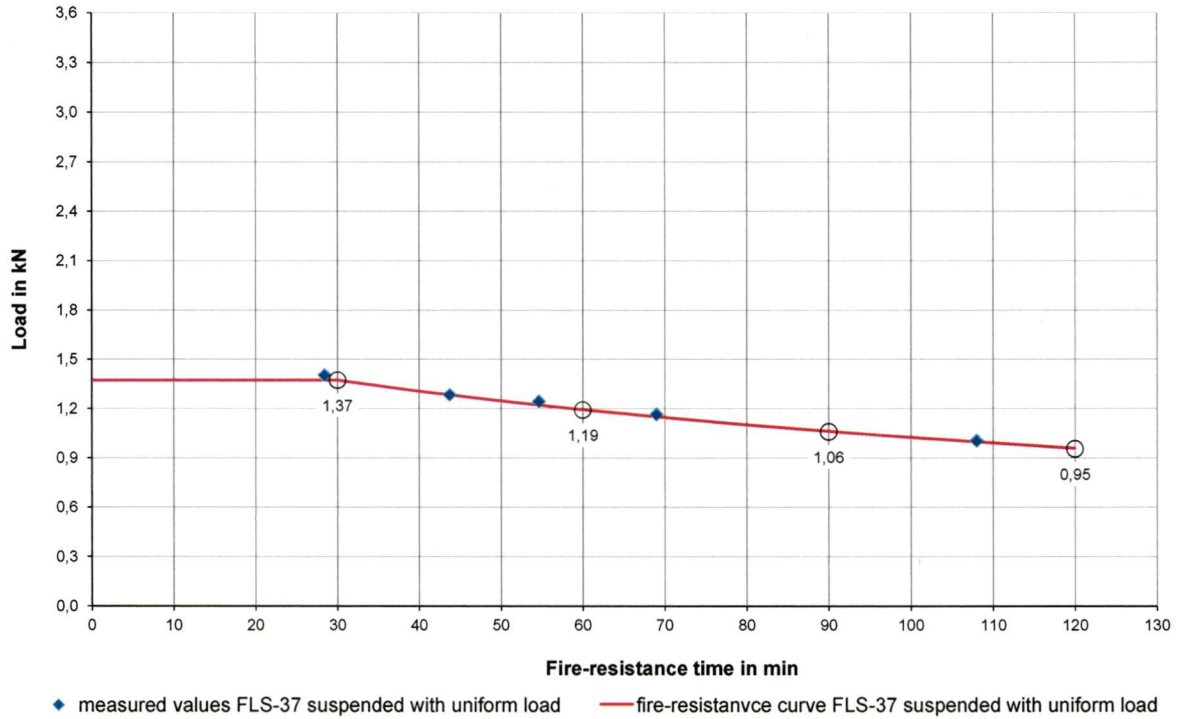

Diagram A2.6 Load-deformation curve for FLS 37/1.2, suspended with uniform load with a fire-resistance period of 30 minutes

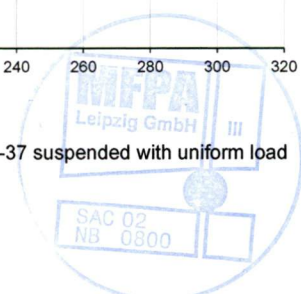
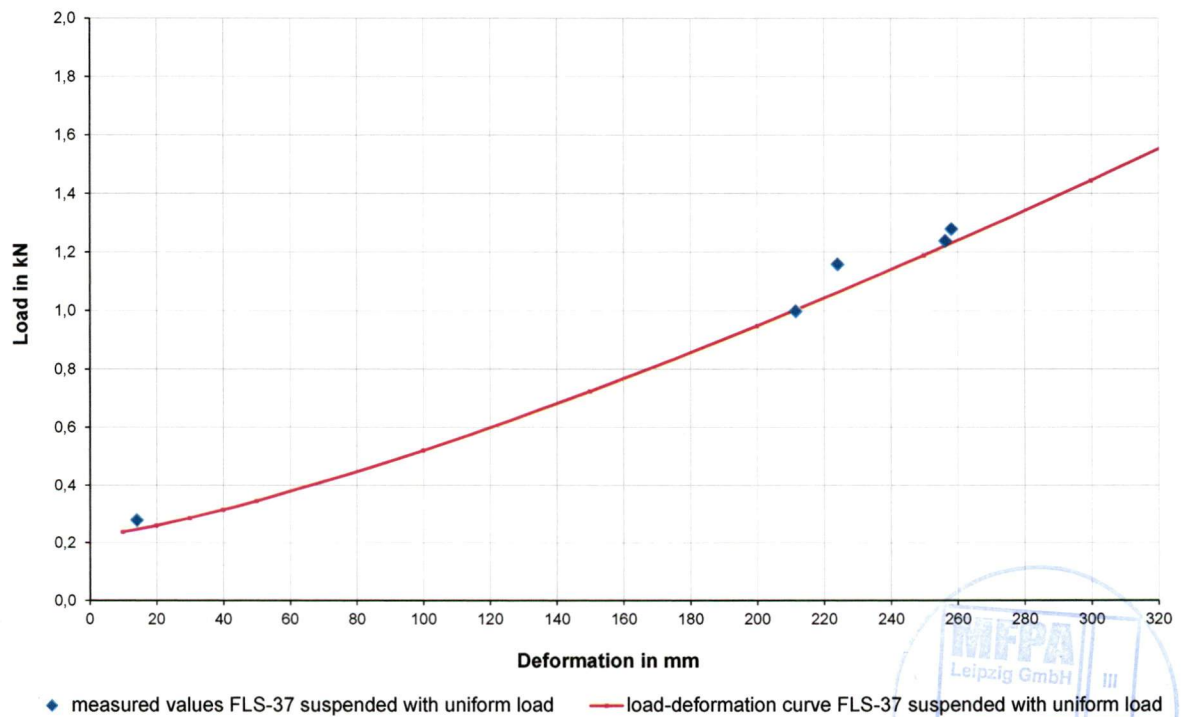

Diagram A2.7 Fire-resistance curve for FLS 37/1.2 as cantilever arm ALK 37/1.2 with single load

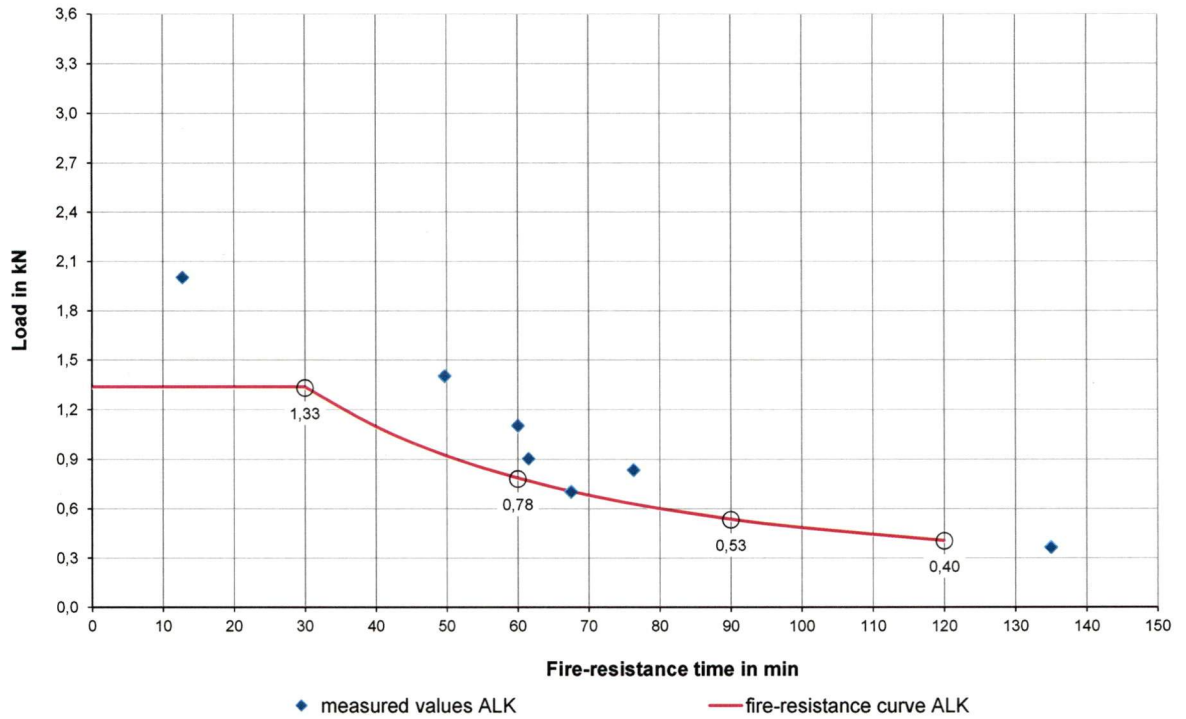

Diagram A2.8 Load-deformation curve for FLS 37/1.2 as cantilever arm ALK 37/1.2 with single load with a fire-resistance period of 30 minutes

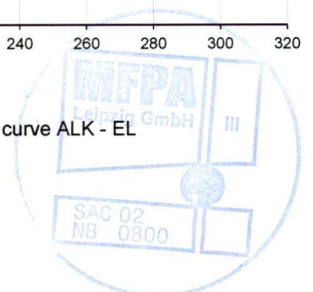
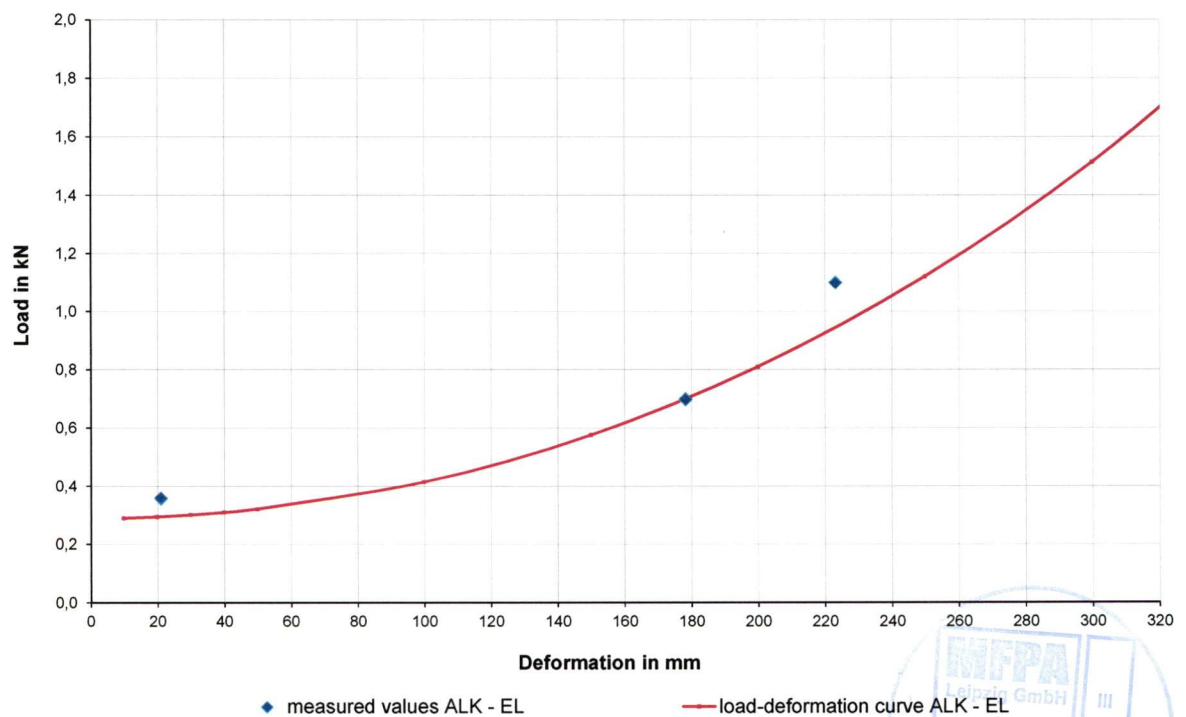
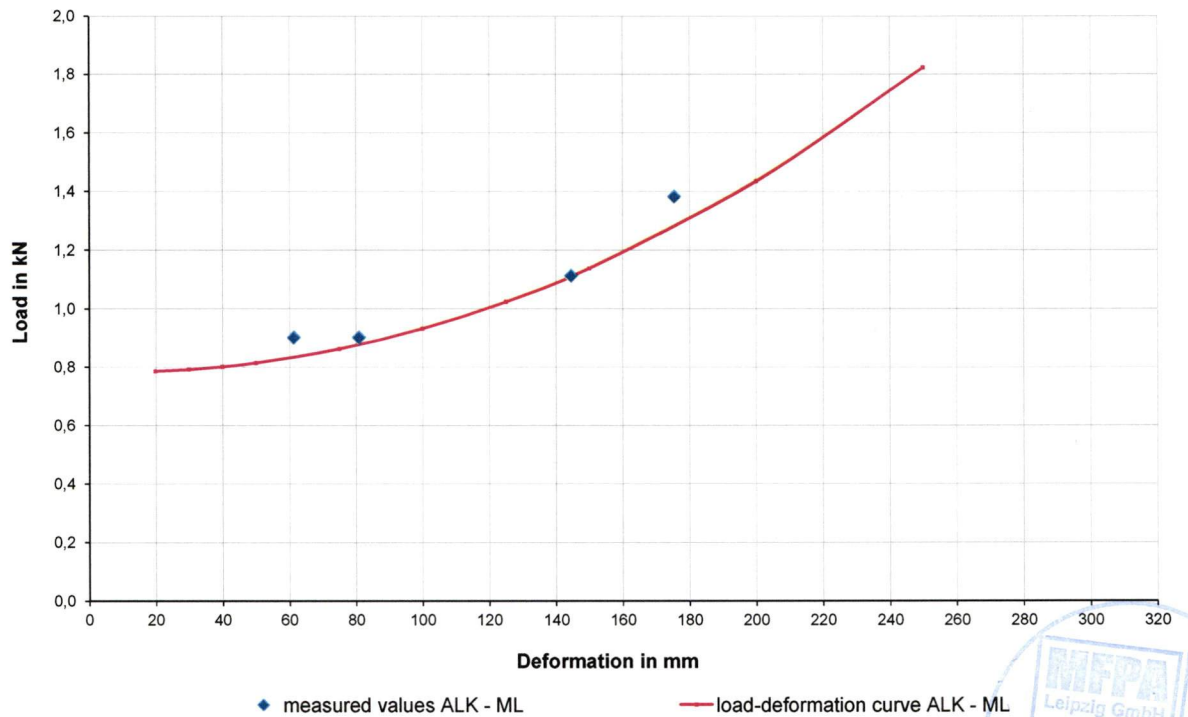

Diagram A2.9 Load-deformation curve for FLS 37/1.2 as cantilever arm ALK 37/1.2 with triple load with a fire-resistance period of 30 minutes



◆ measured values ALK - ML

— load-deformation curve ALK - ML

