

Approval body for construction products
and types of construction

Bautechnisches Prüfamt

An institution established by the Federal and
Laender Governments



European Technical Assessment

ETA-19/0520
of 21 February 2022

English translation prepared by DIBt - Original version in German language

General Part

Technical Assessment Body issuing the
European Technical Assessment:

Deutsches Institut für Bautechnik

Trade name of the construction product

fischer Bolt Anchor FAZ II Plus, FAZ II Plus R, FAZ II
Plus HCR

Product family
to which the construction product belongs

Mechanical fasteners for use in concrete

Manufacturer

fischerwerke GmbH & Co. KG
Klaus-Fischer-Straße 1
72178 Waldachtal
DEUTSCHLAND

Manufacturing plant

fischerwerke

This European Technical Assessment
contains

21 pages including 3 annexes which form an integral part
of this assessment

This European Technical Assessment is
issued in accordance with Regulation (EU)
No 305/2011, on the basis of

EAD 330232-01-0601 Edition 05/2021

The European Technical Assessment is issued by the Technical Assessment Body in its official language. Translations of this European Technical Assessment in other languages shall fully correspond to the original issued document and shall be identified as such.

Communication of this European Technical Assessment, including transmission by electronic means, shall be in full. However, partial reproduction may only be made with the written consent of the issuing Technical Assessment Body. Any partial reproduction shall be identified as such.

This European Technical Assessment may be withdrawn by the issuing Technical Assessment Body, in particular pursuant to information by the Commission in accordance with Article 25(3) of Regulation (EU) No 305/2011.

Specific Part

1 Technical description of the product

The Fischer Bolt Anchor FAZ II Plus, FAZ II Plus R, FAZ II Plus HCR is an anchor made of galvanized steel (FAZ II Plus), stainless steel (FAZ II Plus R) or high corrosion resistant steel (FAZ II Plus HCR) which is placed into a drilled hole and anchored by torque-controlled expansion.

The product description is given in Annex A.

2 Specification of the intended use in accordance with the applicable European Assessment Document

The performances given in Section 3 are only valid if the anchor is used in compliance with the specifications and conditions given in Annex B.

The verifications and assessment methods on which this European Technical Assessment is based lead to the assumption of a working life of the anchor of at least 50 years. The indications given on the working life cannot be interpreted as a guarantee given by the producer, but are to be regarded only as a means for choosing the right products in relation to the expected economically reasonable working life of the works.

3 Performance of the product and references to the methods used for its assessment

3.1 Mechanical resistance and stability (BWR 1)

Essential characteristic	Performance
Characteristic resistance to tension load (static and quasi-static loading), Method A	See Annex C1, C5 and C6
Characteristic resistance to shear load (static and quasi-static loading)	See Annex C2
Displacements and Durability	See Annex C9 and B1
Characteristic resistance and displacements for seismic performance categories C1 and C2	See Annex C7 to C9

3.2 Safety in case of fire (BWR 2)

Essential characteristic	Performance
Reaction to fire	Class A1
Resistance to fire	See Annex C3 and C4

English translation prepared by DIBt

4 Assessment and verification of constancy of performance (AVCP) system applied, with reference to its legal base

In accordance with the European Assessment Document EAD 330232-01-0601 the applicable European legal act is: [96/582/EC].

The system to be applied is: 1

5 Technical details necessary for the implementation of the AVCP system, as provided for in the applicable EAD

Technical details necessary for the implementation of the AVCP system are laid down in the control plan deposited with Deutsches Institut für Bautechnik.

Issued in Berlin on 21 February 2022 by Deutsches Institut für Bautechnik

Dipl.-Ing. Beatrix Wittstock
Head of Section

beglaubigt:
Ziegler

Cone bolt manufactured by cold - forming:

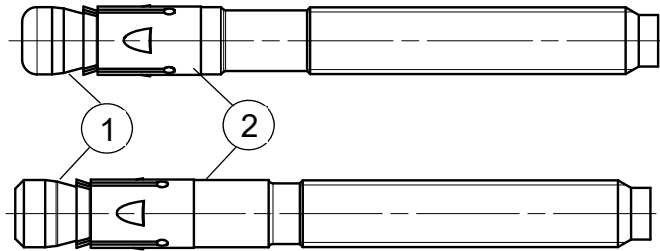

Cone bolt manufactured by turning:

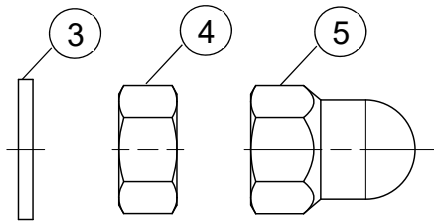

- ① Expansion sleeve
- ② Cone bolt (cold – formed or turned)
- ③ Washer
- ④ Hexagon nut
- ⑤ fischer FAZ II Plus dome nut

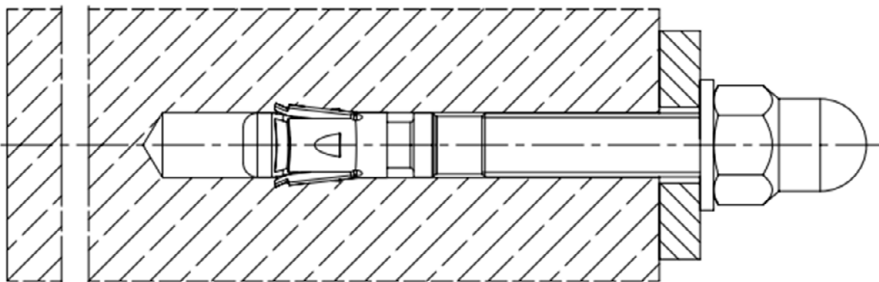
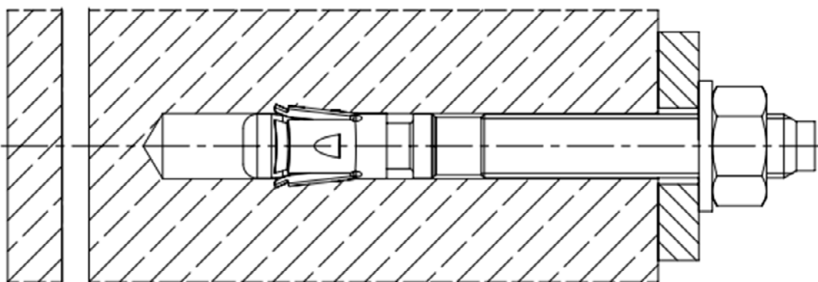

(Figure not to scale)

fischer Bolt Anchor FAZ II Plus, FAZ II Plus R, FAZ II Plus HCR

Product description
Installed condition

Annex A1

Product marking and letter-code:

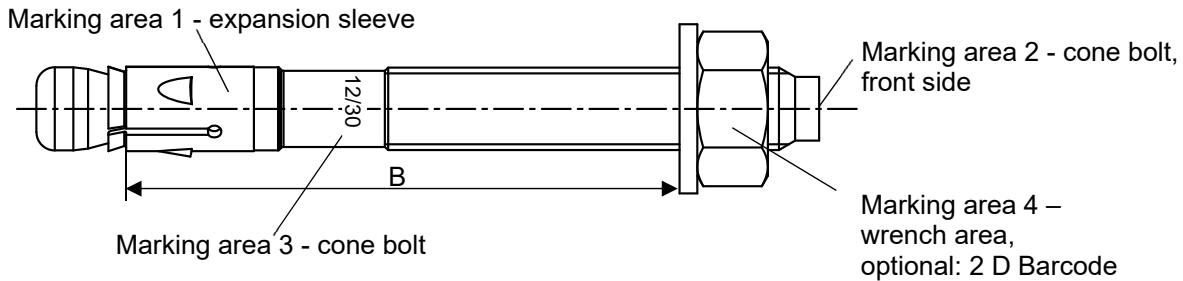

Product marking, example: FAZ II + 12/30 R

Brand | type of fastener placed at marking area 1 or 3

Thread size / max. thickness of the fixture (t_{fix}) identification R or HCR placed at marking area 1 or 3

- FAZ II Plus: carbon steel, galvanised
- FAZ II Plus R: stainless steel
- FAZ II Plus HCR: high corrosion resistant steel

Table A2.1: Letter - code at marking area 2:

Marking	(a)	(b)	(c)	(d)	(A)	(B)	(C)	(D)	(E)	(F)	(G)	(H)	(I)	(K)
Max. t_{fix} [mm]	5	10	15	20	5	10	15	20	25	30	35	40	45	50
B ≥ [mm]	M6	-			45	50	55	60	65	70	75	80	85	90
	M8	40	45	-		50	55	60	65	70	75	80	85	90
	M10	45	50	55	60	65	70	75	80	85	90	95	100	105
	M12	55	60	65	70	75	80	85	90	95	100	105	110	115
	M16	70	75	80	85	90	95	100	105	110	115	120	125	130
	M20	-				105	110	115	120	125	130	135	140	145
	M24	-				130	135	140	145	150	155	160	165	170

Marking	(L)	(M)	(N)	(O)	(P)	(R)	(S)	(T)	(U)	(V)	(W)	(X)	(Y)	(Z)
Max. t_{fix} [mm]	60	70	80	90	100	120	140	160	180	200	250	300	350	400
B ≥ [mm]	M6	100	110	120	130	140	160	180	200	220	240	290	340	390
	M8	105	115	125	135	145	165	185	205	225	245	295	345	395
	M10	120	130	140	150	160	180	200	220	240	260	310	360	410
	M12	130	140	150	160	170	190	210	230	250	270	320	370	420
	M16	145	155	165	175	185	205	225	245	265	285	335	385	435
	M20	160	170	180	190	200	220	240	260	280	300	350	400	450
	M24	185	195	205	215	225	245	265	285	305	325	375	425	475

Calculation existing h_{ef} for installed fasteners:

existing $h_{ef} = B_{(according\ to\ table\ A2.1)} - existing\ t_{fix}$

Thickness of the fixture t_{fix} including thickness of filling conical washer t and e.g. thickness of grout layer t_{grout} or other non-structural layers

(Figure not to scale)

fischer Bolt Anchor FAZ II Plus, FAZ II Plus R, FAZ II Plus HCR

Product description
Product marking and letter code

Annex A2

Product dimensions

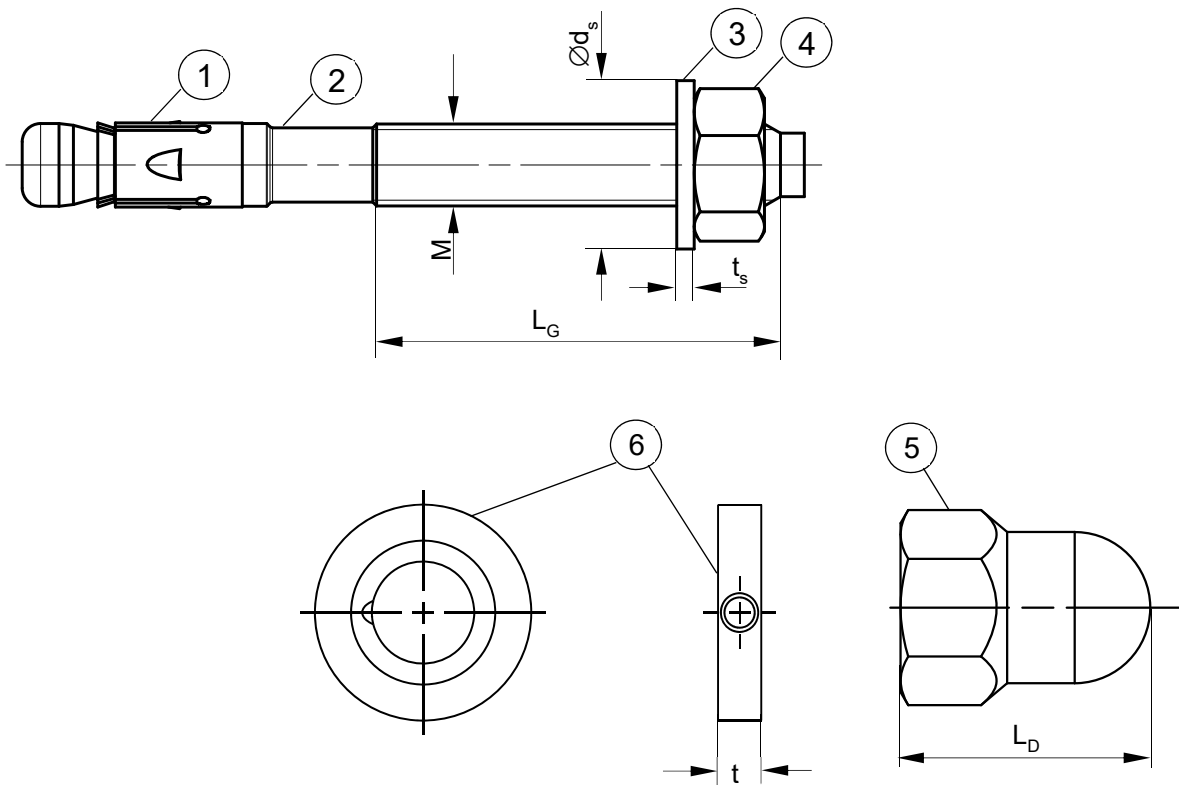

Table A3.1: Dimensions [mm]

Part	Designation	FAZ II Plus, FAZ II Plus R, FAZ II Plus HCR							
		M6	M8	M10	M12	M16	M20	M24	
1	Expansion sleeve	Sheet thickness	0,8	1,3	1,4	1,6	2,4		3,0
2	Cone bolt	Thread size M	6	8	10	12	16	20	24
		L_G	10	19	26	31	40	50	57
3	Washer	t_s	$\geq 1,4$		1,8	2,3	$\geq 2,7$		3,7
		$\varnothing d_s$	11	15	19	23	29	36	43
4 & 5	Hexagon nut / fischer FAZ II Plus dome nut	Wrench size ¹⁾	10	13	17	19	24	30	36
5		L_D	$\geq -^2)$		22	27	33	$-^2)$	
6	fischer filling conical washer FFD	t	= 6			7	8	10	

¹⁾ Alternatively according to ISO 4032:2013 allowed

²⁾ Not part of the assessment

(Figure not to scale)

fischer Bolt Anchor FAZ II Plus, FAZ II Plus R, FAZ II Plus HCR



Product description
Dimensions

Annex A3

Table A4.1: Materials FAZ II Plus				
Part	Designation	Material		
		FAZ II Plus	FAZ II Plus R	FAZ II Plus HCR
	Steel grade	Steel	Stainless steel R EN 10088:2014	High corrosion resistant steel HCR EN 10088:2014
		Zinc plated $\geq 5 \mu\text{m}$, ISO 4042:2018	Corrosion resistance class CRC III in accordance with EN 1993-1-4:2006+A1:2015	Corrosion resistance class CRC V in accordance with EN 1993-1-4:2006+A1:2015
1	Expansion sleeve	Cold strip, EN 10139:2016 or stainless steel EN 10088:2014	Stainless steel EN 10088:2014	
2	Cone bolt	Cold form steel or free cutting steel	Stainless steel EN 10088:2014	High corrosion resistant steel EN 10088:2014
3	Washer	Cold strip, EN 10139:2016		
4 / 5	Hexagon nut / fischer FAZ II Plus dome nut	Steel, property class min. 8, EN ISO 898-2:2012	Stainless steel EN 10088:2014; ISO 3506-2:2020; property class – min. 70	High corrosion resistant steel EN 10088:2014; ISO 3506-2:2020; property class – min. 70
6	fischer filling conical washer FFD	Cold form steel or free cutting steel	Stainless steel EN 10088:2014	High corrosion resistant steel EN 10088:2014
fischer Bolt Anchor FAZ II Plus, FAZ II Plus R, FAZ II Plus HCR				Annex A4
Product description Materials				

Specifications of intended use

Fastenings subject to:

Size	FAZ II Plus, FAZ II Plus R, FAZ II Plus HCR						
	M6	M8	M10	M12	M16	M20	M24
Hammer drilling with standard drill bit 	✓						
Hammer drilling with hollow drill bit with automatic cleaning 	- ¹⁾	✓					
Diamond drilling 	- ¹⁾	✓	(for non seismic applications only)				
Static and quasi-static loads	✓						
Cracked and uncracked concrete							
Fire exposure							
Seismic performance category	C1	- ¹⁾	✓				
	C2	- ¹⁾		✓			

¹⁾ No performance assessed

Base materials:

- Compacted reinforced and unreinforced normal weight concrete without fibres (cracked or uncracked) according to EN 206-1:2013+A2:2021
- Strength classes C20/25 to C50/60 according to EN 206:2013+A2:2021

Use conditions (Environmental conditions):

- Structures subject to dry internal conditions (FAZ II Plus, FAZ II Plus R, FAZ II Plus HCR)
- For all other conditions according to EN 1993-1-4:2006 + A1:2015 corresponding to corrosion resistance class
 - CRC III: for FAZ II Plus R
 - CRC V: for FAZ II Plus HCR

Design:

- Fastenings are to be designed under the responsibility of an engineer experienced in fastenings and concrete work
- Verifiable calculation notes and drawings are to be prepared taking account of the loads to be anchored. The position of the fastener is indicated on the design drawings (e.g. position of the fastener relative to reinforcement or to supports, etc.)
- Fastenings in stand-off installation or with a grout layer under seismic action are not covered
- In case of seismic applications the fastener shall be positioned outside of critical regions (e.g. plastic hinges) of the concrete structure
- Design of fastenings according to EN 1992-4:2018 and EOTA Technical Report TR 055:2018

fischer Bolt Anchor FAZ II Plus, FAZ II Plus R, FAZ II Plus HCR

Intended Use
Specifications

Annex B1

Table B2.1: Installation parameters

Size	FAZ II Plus, FAZ II Plus R, FAZ II Plus HCR						
	M6	M8	M10	M12	M16	M20	M24
Nominal drill hole diameter $d_0 =$	6	8	10	12	16	20	24
Maximum bit diameter with hammer or hollow drilling $d_{cut,max}$ [mm]	6,40	8,45	10,45	12,5	16,5	20,55	24,55
Maximum bit diameter with diamond drilling	- ¹⁾	8,15		12,25	16,45	20,50	24,40
Effective embedment depth $h_{ef} \geq$	40-80	35-90	40-100	50-125	65-160	100-180	125
Length from h_{ef} to end of cone bolt L	6,5	9,5	11,5	13,5	17,5	20,0	23,5
Overall fastener embedment depth in the concrete $h_{nom} \geq$ [mm]	$h_{ef} + L$						
Depth of drill hole to deepest point $h_1 \geq$	$h_{nom} + 3$		$h_{nom} + 5$		$h_{nom} + 10$		
Diameter of clearance hole in the fixture $d_f \leq$ [mm]	7	9	12	14	18	22	26
Required setting torque $T_{inst} =$ [Nm]	8	20	45	60	110	200	270
Excess length after hammering-in the cone bolt (for fischer dome nut applications according to Annex B4) $O =$ [mm]	- ¹⁾		12	16	20	- ¹⁾	

¹⁾ Not part of the assessment

Setting gauge FAZ II Plus SL-H
for fastener with fischer FAZ II Plus dome nut:

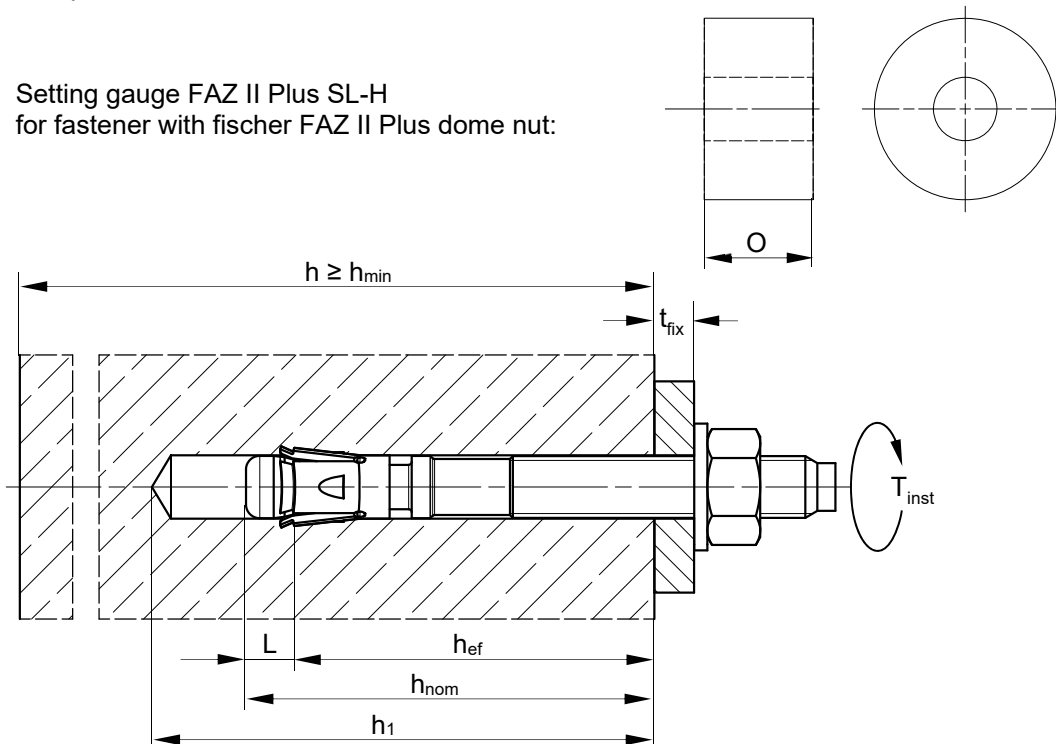

h_{ef} = Effective embedment depth
 t_{fix} = Thickness of the fixture
 h_1 = Depth of drill hole to deepest point
 h = Thickness of the concrete member
 h_{min} = Minimum thickness of concrete member
 h_{nom} = Overall fastener embedment depth in the concrete

O = Length of setting gauge
 L = Length from h_{ef} to end of cone bolt
 T_{inst} = Required setting torque

fischer Bolt Anchor FAZ II Plus, FAZ II Plus R, FAZ II Plus HCR

Intended Use
Installation parameters





Annex B2

Installation instructions:

- Fastener installation carried out by appropriately qualified personnel according to the design drawings and under the supervision of the person responsible for technical matters on the site
- Use of the fastener only as supplied by the manufacturer without exchanging the components of the fastener
Exception: fischer FAZ II Plus dome nut
- Hammer, hollow or diamond drilling according to Annex B1 + B2
- Drill hole created perpendicular +/- 5° to concrete surface, positioning without damaging the reinforcement
- In case of aborted hole: new drilling at a minimum distance twice the depth of the aborted drill hole or smaller distance if the aborted drill hole is filled with high strength mortar and if under shear or oblique tension load it is not in the direction of load application

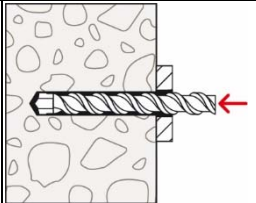
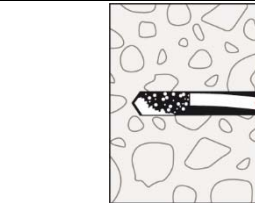
Installation instructions: Drilling and cleaning the hole

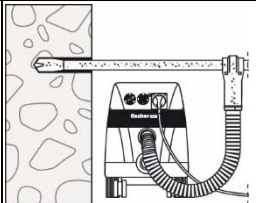
Types of drills and cleaning

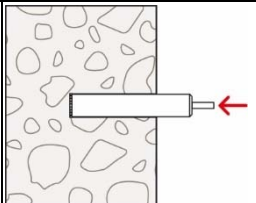
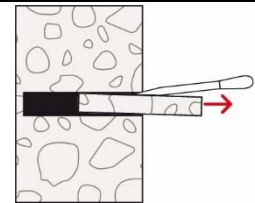
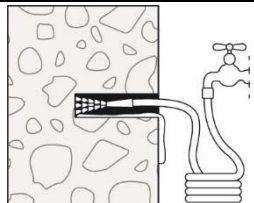
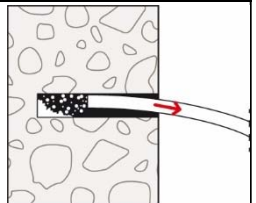
<p>Hammer drill (e.g. fischer Quattric II)</p>		 <p>1: Drill the hole</p>	 <p>2: Clean the hole</p>	<p>Continue with step 5</p>	
<p>Hollow drill (e.g. fischer FHD)</p>		 <p>1: Drill the hole with automatic cleaning (e.g. fischer FVC)</p>	 <p>Cleaning obsolete</p>	<p>Continue with step 5</p>	
<p>Diamond drill, for non seismic applications only</p>		 <p>1: Drill the hole</p>	 <p>2: Break the drill core and remove it</p>	 <p>3: Flush the drill hole, until clear water emerges from the drill hole</p>	 <p>4: Clean the hole</p>

fischer Bolt Anchor FAZ II Plus, FAZ II Plus R, FAZ II Plus HCR

Intended Use
Installation instructions

Annex B3

Installation instructions: Installation of the fastener

HEXAGON NUT:

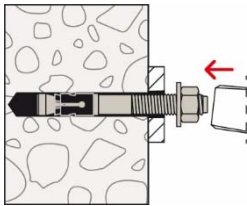

5.a: Set the fastener
e.g. with hammer

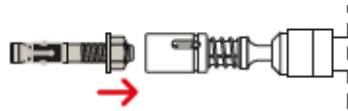

5.b: Set the fastener
e.g. fischer FA-ST II

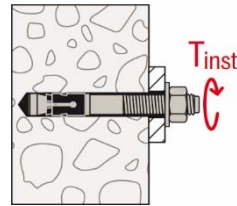

6: Apply T_{inst}

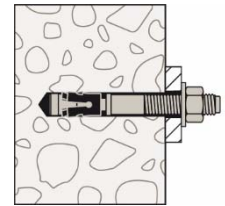

7: Installed fastener

fischer FAZ II Plus DOME NUT:

Option 1: Push through installation with setting gauge SL-H:

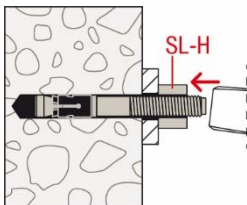

5.1: Set the fastener
through the set-
ting gauge and
fixture

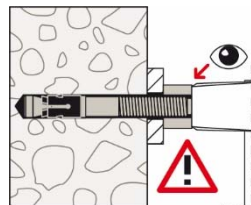

5.2: Check offset

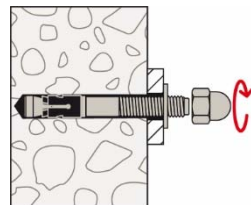

5.3: Turn on the
fischer FAZ II
Plus dome nut

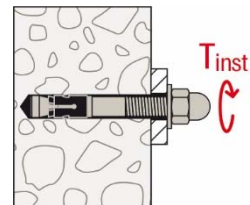

6: Apply T_{inst}

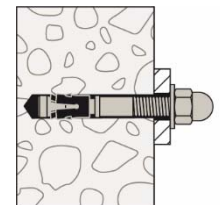

7: Installed fastener

Option 2: Push through installation with hexagon nut:

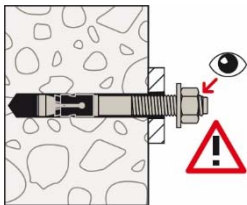

5.1: Check setting
position: Visible
one turn of a
thread

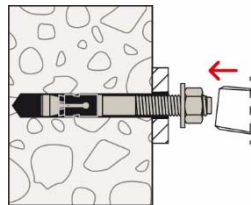

5.2: Set the fastener

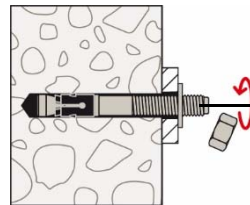

5.3: Remove nut

fischer Filling conical washer FFD optional for seismic C2 application or minimising the annular gap:

Optional

The gap between bolt and fixture may be filled with mortar (compressive strength $\geq 50 \text{ N/mm}^2$ e.g. fischer FIS SB) after last step (for eliminating the annular gap). The FFD is additional to the standard washer. The thickness of the FFD must be considered for definition of t_{fix} . Countersunk of the FFD in direction to the anchor plate. Installation with hexagon nut or dome nut is permitted.

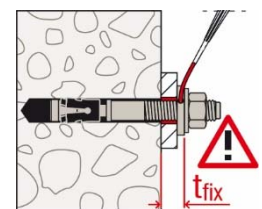
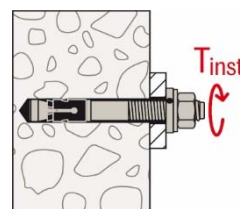
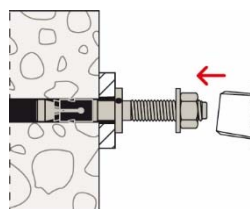
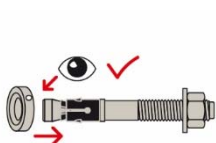

fischer Bolt Anchor FAZ II Plus, FAZ II Plus R, FAZ II Plus HCR

Intended Use
Installation instructions

Annex B4

Table C1.1: Characteristic values of tension resistance under static and quasi-static action												
Size		FAZ II Plus, FAZ II Plus R, FAZ II Plus HCR										
		M6	M8	M10	M12	M16	M20	M24				
Steel failure												
Characteristic resistance	FAZ II Plus	$N_{Rk,s}$ [kN]	11,3	19,9	32,7	49,3	78,7	108,4	180,0			
	FAZ II Plus R		12,1	21,0	34,5	52,0	83,0	127,6	187,0			
	FAZ II Plus HCR		11,3	17,6	29,1	43,8	69,9					
Partial factor for steel failure	FAZ II Plus	$\gamma_{Ms}^{1)}$ [-]	1,4					1,4	1,5			
	FAZ II Plus R		1,4					1,45				
	FAZ II Plus HCR		1,5	1,45			1,4	1,5				
Pullout failure												
Effective embedment depth for calculation	h_{ef} [mm]		40-80	40 ³⁾ - < 45	45-90	40-100	50-125	65-160	100-180	125		
Characteristic resistance in cracked concrete C20/25	$N_{Rk,p}$ (C20/25) [kN]		1,5	5,5	8	13	20	27,0	34,4	48,1		
Characteristic resistance in uncracked concrete C20/25			10,5	14		20	22	38,6	49,2	68,8		
Increasing factor ψ_c for cracked or uncracked concrete	$N_{Rk,p} = \psi_c \cdot N_{Rk,p}$ (C20/25)	[-]	C25/30	1,12								
			C30/37	1,22								
			C35/45	1,32								
			C40/50	1,41								
			C45/55	1,50								
			C50/60	1,58								
Installation sensitivity factor	γ_{inst} [-]		1,0									
Concrete cone and splitting failure												
Factor for uncracked concrete	$k_{ucr,N}$ [-]		11,0 ²⁾									
Factor for cracked concrete	$k_{cr,N}$ [-]		7,7 ²⁾									
Characteristic spacing	$s_{cr,N}$ [mm]		$3 \cdot h_{ef}$									
Characteristic edge distance	$c_{cr,N}$ [mm]		$1,5 \cdot h_{ef}$									
Characteristic spacing for splitting failure	$s_{cr,sp}$ [mm]		$2 \cdot c_{cr,sp}$									
Characteristic edge distance for splitting failure h	$c_{cr,sp}$ [mm]	[mm]	≥ 80	40	$2,4 \cdot h_{ef}$	$2 \cdot h_{ef}$	- ⁵⁾					
			≥ 100		$2 \cdot h_{ef}$	$2,4 \cdot h_{ef}$					$2 \cdot h_{ef}$	
			≥ 120			$1,9 \cdot h_{ef}$					$2,1 \cdot h_{ef}$	
			≥ 140		$1,9 \cdot h_{ef}$	$1,5 \cdot h_{ef}$					$2 \cdot h_{ef}$	$2,4 \cdot h_{ef}$
			≥ 160			$1,5 \cdot h_{ef}$					$2 \cdot h_{ef}$	
≥ 200	$2,2 \cdot h_{ef}$											
Characteristic resistance to splitting	$N^0_{Rk,sp}$ [kN]		$\min \{N^0_{Rk,c}; N_{Rk,p}\}^{4)}$									
fischer Bolt Anchor FAZ II Plus, FAZ II Plus R, FAZ II Plus HCR								Annex C1				
Performances Characteristic values of tension resistance under static and quasi-static action												

1) In absence of other national regulations

2) Based on concrete strength as cylinder strength

3) For dry internal exposure and statically indeterminate redundant components, the minimum effective embedment depth can be reduced to 35 mm without reduction of $N_{Rk,p}$.

4) $N^0_{Rk,c}$ according to EN 1992-4:2018

5) No performance assessed

Table C2.1: Characteristic values of **shear** resistance under static and quasi-static action

Size		FAZ II Plus, FAZ II Plus R, FAZ II Plus HCR						
		M6	M8	M10	M12	M16	M20	M24
Steel failure without lever arm								
Characteristic resistance	FAZ II Plus without filling of the annular gap	7,5	16,3	26,2	37,0	68,4	82,9	128,3
	FAZ II Plus with filling		18,1	27,3	40,7	69,8	85,6	
	FAZ II Plus without filling R	8,8	17,6	26,5	42,1	71,1	107,9	158,1
	FAZ II Plus with filling R			27,6	44,3	73,6	117,9	
	FAZ II Plus without filling HCR		17,4	23,7	42,1	71,1	107,9	
	FAZ II Plus with filling HCR			27,9		73,6	117,9	
Partial factor for steel failure	$\gamma_{Ms}^{1)}$	1,25						
Factor for ductility	k_7	1,0						
Steel failure with lever arm and Concrete pryout failure								
Effective embedment depth for calculation	h_{ef} [mm]	40-80	45-90	60-100	70-125	85-160	100-180	125
Characteristic bending resistance	FAZ II Plus	11	30	60	105	266	422	864
	FAZ II Plus R		29	59	100	256	519	898
	FAZ II Plus HCR							
Factor for pryout failure	k_8 [-]	2,6	2,8	3,2				
Effective embedment depth for calculation	h_{ef} [mm]	- ²⁾	40 ³⁾ - < 45	40 - < 60	50 - < 70	65 - < 85	- ²⁾	
Characteristic bending resistance	FAZ II Plus		27	56	105	251		
	FAZ II Plus R		29	59	100	256		
	FAZ II Plus HCR		24	50		223		
Factor for pryout failure	k_8 [-]	2,5	2,6	3,1	3,2			
Partial factor for steel failure	$\gamma_{Ms}^{1)}$	1,25						
Factor for ductility	k_7	1,0						
Concrete edge failure								
Effective embedment depth for calculation	l_f [mm]	h_{ef}						
Outside diameter of a fastener	d_{nom} [mm]	6	8	10	12	16	20	24
<p>¹⁾ In absence of other national regulations</p> <p>²⁾ No performance assessed</p> <p>³⁾ For dry internal exposure and statically indeterminate redundant components, the minimum effective embedment depth can be reduced to 35 mm without reduction of $N_{Rk,p}$.</p>								
fischer Bolt Anchor FAZ II Plus, FAZ II Plus R, FAZ II Plus HCR							Annex C2	
Performances Characteristic values of shear resistance under static and quasi-static action								

Table C3.1: Characteristic values of tension resistance under fire exposure

Size		FAZ II Plus, FAZ II Plus R, FAZ II Plus HCR													
		M6		M8		M10		M12		M16		M20		M24	
		$h_{ef} \geq$ [mm]	40	35	45	40	60	50	70	65	85	100	125		
Characteristic resistance steel failure	FAZ II Plus	$N_{Rk,s,fi}$	R30	0,6 ¹⁾ / 0,9 ²⁾		1,4	2,8		5,0	9,4		14,7	21,1		
		R60	0,4 ¹⁾ / 0,9 ²⁾		1,2	2,3		4,1	7,7		12,0	17,3			
		R90	0,3 ¹⁾ / 0,9 ²⁾		0,9	1,9		3,2	6,0		9,4	13,5			
		R120	0,2 ¹⁾ / 0,7 ²⁾		0,8	1,6		2,8	5,2		8,1	11,6			
	FAZ II Plus R / HCR	$N_{Rk,s,fi}$	R30	0,6 ¹⁾ / 0,9 ²⁾		3,6	7,8		11,5	21,8		34,3	49,4		
		R60	0,4 ¹⁾ / 0,9 ²⁾		2,3	4,8		7,1	13,2		20,7	29,3			
		R90	0,3 ¹⁾ / 0,9 ²⁾		1,9	3,8		5,7	10,5		18,3	26,4			
		R120	0,2 ¹⁾ / 0,7 ²⁾		1,6	3,3		4,9	8,6		17,3	25,0			
Characteristic resistance Concrete cone failure		$N_{Rk,c,fi}$	R30 - R90	$7,7 \cdot h_{ef}^{1,5} \cdot (20)^{0,5} \cdot h_{ef} / 200 / 1000$											
			R120	$7,7 \cdot h_{ef}^{1,5} \cdot (20)^{0,5} \cdot h_{ef} / 200 / 1000 \cdot 0,8$											
Characteristic resistance pullout failure		$N_{Rk,p,fi}$	R30	0,4	0,9	2,0	2,2	3,3	3,0	5,0	4,5	6,8	8,6	12,0	
			R60		0,8										
			R90		0,5										
			R120	0,3		1,6	1,7	2,6	2,4	4,0	3,6	5,4	6,9	9,6	

Table C3.2: Characteristic values of shear resistance under fire exposure

FAZ II Plus		$h_{ef} \geq$ [mm]		R30		R60	
				$V_{Rk,s,fi,30}$ [kN]	$M^0_{Rk,s,fi,30}$ [Nm]	$V_{Rk,s,fi,60}$ [kN]	$M^0_{Rk,s,fi,60}$ [Nm]
M6	40	0,6 ¹⁾ / 0,9 ²⁾	0,5 ¹⁾ / 0,2 ²⁾	0,4 ¹⁾ / 0,9 ²⁾	0,3 ¹⁾ / 0,1 ²⁾		
M8	35	1,8	1,4	1,6	1,2		
M10	40	3,6	3,6	2,9	3,0		
M12	50	6,3	7,8	4,9	6,4		
M16	65	11,7	19,9	9,1	16,3		
M20	100	18,2	39,0	14,2	31,8		
M24	125	26,3	67,3	20,5	55,0		

FAZ II Plus		$h_{ef} \geq$ [mm]		R90		R120	
				$V_{Rk,s,fi,90}$ [kN]	$M^0_{Rk,s,fi,90}$ [Nm]	$V_{Rk,s,fi,120}$ [kN]	$M^0_{Rk,s,fi,120}$ [Nm]
M6	40	0,3 ¹⁾ / 0,9 ²⁾	0,2 ¹⁾ / 0,1 ²⁾	0,2 ¹⁾ / 0,7 ²⁾	0,2 ¹⁾ / 0,1 ²⁾		
M8	35	1,3	1,0	1,2	0,8		
M10	40	2,2	2,4	1,9	2,1		
M12	50	3,5	5,0	2,8	4,3		
M16	65	6,6	12,6	5,3	11,0		
M20	100	10,3	24,6	8,3	21,4		
M24	125	14,8	42,6	11,9	37,0		

Concrete pryout failure according to EN 1992-4:2018

¹⁾ FAZ II Plus

²⁾ FAZ II Plus R / FAZ II Plus HCR

fischer Bolt Anchor FAZ II Plus, FAZ II Plus R, FAZ II Plus HCR

Performances
Characteristic values of resistance under fire exposure

Annex C3

Table C4.1: Characteristic values of shear resistance under fire exposure

FAZ II Plus R, FAZ II Plus HCR			R30		R60	
			$V_{Rk,s,fi,30}$ [kN]	$M^0_{Rk,s,fi,30}$ [Nm]	$V_{Rk,s,fi,60}$ [kN]	$M^0_{Rk,s,fi,60}$ [Nm]
M6	$h_{ef} \geq$	40	0,6 ¹⁾ / 0,9 ²⁾	0,5 ¹⁾ / 0,2 ²⁾	0,4 ¹⁾ / 0,9 ²⁾	0,3 ¹⁾ / 0,1 ²⁾
M8		35	3,6	3,7	2,3	2,4
M10		40	7,8	10,1	4,8	6,2
M12		50	11,5	17,9	7,1	11,1
M16		65	21,8	46,2	13,2	27,9
M20		100	34,3	90,9	20,7	54,9
M24		125	49,4	157,2	29,3	93,1
FAZ II Plus R, FAZ II Plus HCR			R90		R120	
			$V_{Rk,s,fi,90}$ [kN]	$M^0_{Rk,s,fi,90}$ [Nm]	$V_{Rk,s,fi,120}$ [kN]	$M^0_{Rk,s,fi,120}$ [Nm]
M6	$h_{ef} \geq$	40	0,3 ¹⁾ / 0,9 ²⁾	0,2 ¹⁾ / 0,1 ²⁾	0,2 ¹⁾ / 0,7 ²⁾	0,2 ¹⁾ / 0,1 ²⁾
M8		35	1,9	1,9	1,6	1,7
M10		40	3,8	4,9	3,3	4,3
M12		50	5,7	8,8	4,9	7,6
M16		65	10,5	22,1	8,6	18,3
M20		100	18,3	48,6	17,3	45,9
M24		125	26,4	84,0	25,0	79,4

¹⁾ FAZ II Plus

²⁾ FAZ II Plus R / FAZ II Plus HCR

Concrete pryout failure according to EN 1992-4:2018

Table C4.2: Minimum spacings and minimum edge distances of fasteners under fire exposure for tension and shear load

Size	FAZ II Plus, FAZ II Plus R, FAZ II Plus HCR						
	M6	M8	M10	M12	M16	M20	M24
Spacing s_{min}	Annex C5						
Edge distance c_{min} [mm]	$c_{min} = 2 \cdot h_{ef}$, for fire exposure from more than one side $c_{min} \geq 300$ mm						

fischer Bolt Anchor FAZ II Plus, FAZ II Plus R, FAZ II Plus HCR

Performances
Characteristic values of resistance under fire exposure

Annex C4

Table C5.1: Minimum thickness of concrete members, minimum spacing and minimum edge distance

Size	FAZ II Plus, FAZ II Plus R, FAZ II Plus HCR							
	M6	M8	M10	M12	M16	M20	M24	
Minimum edge distance								
Uncracked concrete	40	40	45	55	65	95	135	
Cracked concrete						85	100	
Corresponding	s [mm] according to Annex C6							
Minimum thickness of concrete member	80		100	140	160	200		
Thickness of concrete member	h ≥ max. {h _{min} ; 1,5 · h _{ef} }							
Minimum spacing								
Uncracked concrete	35	40	40	50	65	95	100	
Cracked concrete		35						
Corresponding	c [mm] according to Annex C6							
Minimum thickness of concrete member	80		100	140	160	200		
Thickness of concrete member	h ≥ max. {h _{min} ; 1,5 · h _{ef} }							
Minimum splitting area								
Uncracked concrete	A _{sp,req} [-1000 mm ²]	5,1	18	37	54	67	100	117,5
Cracked concrete		1,5	12	27	40	50	77	87,5

Table C5.2: Minimum spacing and minimum edge distances - calculated values for **cracked concrete with one edge** (c₂ and c₃ ≥ 1,5 c₁)

Type of anchor / size	FAZ II Plus, FAZ II Plus R, FAZ II Plus HCR											
	M6	M8	M10	M12	M16	M20	M24					
Effective anchorage depth	h _{ef} ≥ [mm]	40	35	45	40	60	50	70	65	85	100	125
Minimum thickness of concrete member	h ≥ [mm]	80		85	80	120	100	140	140	180	160	200
Minimum spacing	s _{min} [mm]	35		40	50		65		95	100		
	for c ≥ [mm]	40		100	65	120	80	100	75	130	115	
Minimum edge distance	c _{min} [mm]	40		60	45	70	55	65		85	100	
	for s ≥ [mm]	35		160	90	190	125	165	85	230	140	

fischer Bolt Anchor FAZ II Plus, FAZ II Plus R, FAZ II Plus HCR

Performances
Minimum thickness of member, minimum spacing and edge distances

Annex C5

Determination of $A_{sp,ef}$ for each existing free edge

Splitting failure applied for minimum edge distance and spacing in depending on h_{ef}

Definition Index:

cal = calculatory

e.g.: $s_{x,y}$

x = load direction

y = number anchor plate

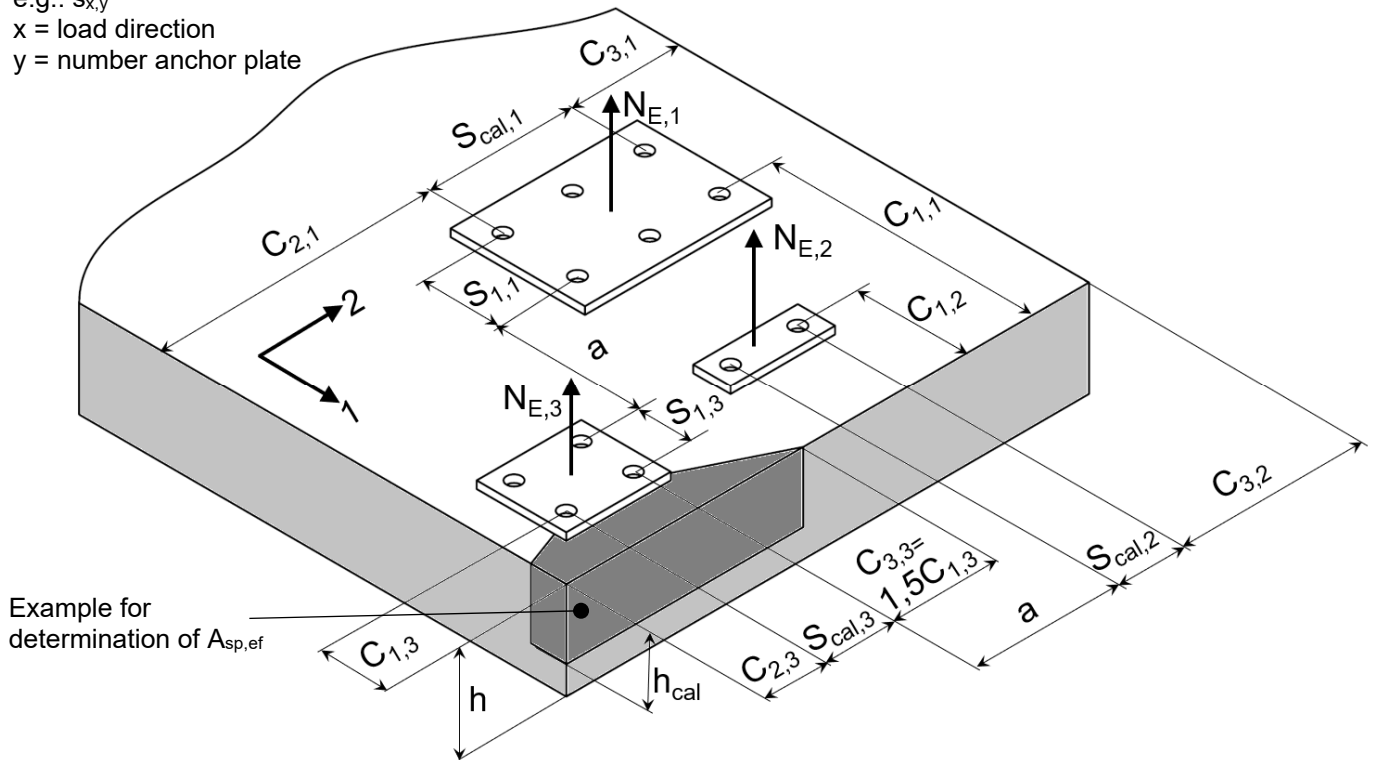

Example for determination of $A_{sp,ef}$

Example for different anchor plates: For considering all free edges the direction 1 and 2 must be swapped.

General formulation for each free edge: $A_{sp,ef} = (C_2 + S_{cal} + C_3) \cdot h_{cal} \geq (n/2) \cdot A_{sp,req}$

with:

Edge distance c_1 : $c_{min} \leq C_1$

Edge distance c_2 : $c_{min} \leq C_2 \leq 1,5 \cdot C_1$

Edge distance c_3 : $c_{min} \leq C_3 \leq 1,5 \cdot C_1$

Calculation spacing, distance between outer anchors s_{cal} : $s_{min} \leq S_{cal} \leq 3,0 \cdot C_1$

Distance between group of anchors a : For $a \geq 3,0 \cdot c_1$ no influence between the anchor groups is taken into account.

Number of anchors n of an anchor plate as well close and parallel to the edge

Effective member thickness h_{cal} : $h_{min} \leq h$; $h_{cal} \leq h$; $h_{cal} \leq (h_{ef} + 1,5 \cdot C_1)$

C_1, C_2, C_3, h and s_{cal} have to be set in way that the requirement is fulfilled

For the calculation of minimum spacing and minimum edge distance of fasteners in combination with different embedment depths and thicknesses of concrete members the following equation shall be fulfilled:

$$A_{sp,req} < A_{sp,ef}$$

$A_{sp,req}$ = required splitting area (according to Annex C 5)

$A_{sp,ef}$ = effective splitting area

(Figure not to scale)

fischer Bolt Anchor FAZ II Plus, FAZ II Plus R, FAZ II Plus HCR

Performances

Minimum thickness of member, minimum spacings and edge distances

Annex C6

Table C7.1: Characteristic values of tension and shear resistance under seismic action category C1

Size		FAZ II Plus, FAZ II Plus R, FAZ II Plus HCR								
		M6	M8		M10	M12	M16	M20	M24	
Effective embedment depth	h_{ef} [mm]	- 2)	40 - <45	45- 90	40-100	50-125	85-160	100-180	125	
With filling of the annular gap	α_{gap} [-]		1,0							
Without filling of the annular gap			0,5							
Steel failure $N_{Rk,s,C1} = N_{Rk,s}$; $\gamma_{Ms,C1} = \gamma_{Ms}$ (see Annex C1)										
Pullout failure										
Characteristic resistance in cracked concrete C1	$N_{Rk,p,C1}$ [kN]	- 2)	5,1	7,4	11,6	20,0	27,0	34,4	48,1	
Installation sensitivity factor	γ_{inst} [-]		1,0							
Concrete cone failure and splitting failure $N_{Rk,c,C1} = N_{Rk,c}$; $N_{Rk,sp,C1} = N_{Rk,sp}$ (see Annex C1)										
Steel failure without lever arm										
FAZ II Plus										
Characteristic resistance C1	h_{ef} [mm]	- 2)	45-90	60-100	70-125	85-160	100-180	125	102,6	
	Without filling		$V_{Rk,s,C1}$ [kN]	14,8	23,6	33,3	58,1	71,2		
	With filling		$V_{Rk,s,C1}$ [kN]	16,5	24,6	39,9	59,3	85,6		
	h_{ef} [mm]		40-<45	40-<60	50-<70	- 2)				
	Without filling		$V_{Rk,s,C1}$ [kN]	- 2)					32,9	
	With filling		$V_{Rk,s,C1}$ [kN]	15,6	19,7	39,9				
	FAZ II Plus R									
	h_{ef} [mm]	- 2)	45-90	60-100	70-125	85-160	100-180	125	126,5	
	Without filling		$V_{Rk,s,C1}$ [kN]	16,0	23,9	37,9	60,4	86,3		
	With filling		$V_{Rk,s,C1}$ [kN]	24,8	43,4	62,6	94,3			
	h_{ef} [mm]		40-<45	40-<60	50-<70	- 2)				
	Without filling		$V_{Rk,s,C1}$ [kN]	- 2)					37,5	
With filling	$V_{Rk,s,C1}$ [kN]		15,1	19,9	43,4					
FAZ II Plus HCR										
h_{ef} [mm]	- 2)	45-90	60-100	70-125	85-160	100-180	125	126,5		
Without filling		$V_{Rk,s,C1}$ [kN]	15,8	21,3	37,9	60,4	86,3			
With filling		$V_{Rk,s,C1}$ [kN]	25,1	41,3	62,6	94,3				
h_{ef} [mm]		40-<45	40-<60	50-<70	- 2)					
Without filling		$V_{Rk,s,C1}$ [kN]	- 2)					37,5		
With filling		$V_{Rk,s,C1}$ [kN]	15,0	20,1	41,3					
Partial factor for steel failure	$\gamma_{Ms,C1}^{1)}$ [-]	1,25								
<p>¹⁾ In absence of other national regulations</p> <p>²⁾ No performance assessed</p>										
fischer Bolt Anchor FAZ II Plus, FAZ II Plus R, FAZ II Plus HCR								Annex C7		
Performances Characteristic values of tension and shear resistance under seismic action category C1										

Table C8.1: Characteristic values of tension and shear resistance under seismic action category C2

Size		FAZ II Plus, FAZ II Plus R, FAZ II Plus HCR						
		M6	M8	M10	M12	M16	M20	M24
With filling of the annular gap	α_{gap} [-]	1,0						
Without filling of the annular gap		0,5						
Steel failure $N_{Rk,s,C2} = N_{Rk,s}$; $\gamma_{Ms,C2} = \gamma_{Ms}$ (see Annex C1)								
Pullout failure								
Characteristic resistance in cracked concrete C2	h_{ef} [mm]	-2)	60-100	70-125	85-160	100-180	125	
	$N_{Rk,p,C2}$ [kN]		5,1	7,4	21,5	30,7	39,6	
	h_{ef} [mm]		40 - <60	50 - <70	65 - <85	-2)		
	$N_{Rk,p,C2}$ [kN]		2,7	4,4	16,4			
Installation sensitivity factor	γ_{inst} [-]	1,0						
Concrete cone failure and splitting failure $N_{Rk,c,C2} = N_{Rk,c}$; $N_{Rk,sp,C2} = N_{Rk,sp}$ (see Annex C1)								
Steel failure without lever arm								
FAZ II Plus								
Characteristic resistance C2	h_{ef} [mm]	-2)	60-100	70-125	85-160	100-180	125	
	Without filling $V_{Rk,s,C2}$ [kN]		17,6	27,8	37,6	62,2	70,6	
	With filling $V_{Rk,s,C2}$ [kN]		20,5	30,5	52,4	68,5	102,6	
	h_{ef} [mm]		40 - <60	50 - <70	65 - <85	-2)		
	Without filling $V_{Rk,s,C2}$ [kN]		14,1	24,4	31,2			
	With filling $V_{Rk,s,C2}$ [kN]		14,7	30,5	52,4			
	FAZ II Plus R							
	h_{ef} [mm]		-2)	60-100	70-125	85-160	100-180	125
	Without filling $V_{Rk,s,C2}$ [kN]			17,8	31,6	39,1	70,5	87,0
	With filling $V_{Rk,s,C2}$ [kN]			20,7	33,2	55,2	104,9	126,5
	h_{ef} [mm]			40 - <60	50 - <70	65 - <85	-2)	
	Without filling $V_{Rk,s,C2}$ [kN]			14,3	27,8	32,4		
With filling $V_{Rk,s,C2}$ [kN]	14,9	33,2		55,2				
FAZ II Plus HCR								
h_{ef} [mm]	-2)	60-100		70-125	85-160	100-180	125	
Without filling $V_{Rk,s,C2}$ [kN]		15,9		31,6	39,1	70,5	87,0	
With filling $V_{Rk,s,C2}$ [kN]		20,9			55,2	104,9	126,5	
h_{ef} [mm]		40 - <60		50 - <70	65 - <85	-2)		
Without filling $V_{Rk,s,C2}$ [kN]		12,8		27,8	32,4			
With filling $V_{Rk,s,C2}$ [kN]		15,1	31,6	55,2				
Partial factor for steel		$\gamma_{Ms,C2}^{1)}$ [-]	1,25					
1) In absence of other national regulations								
2) No performance assessed								
fischer Bolt Anchor FAZ II Plus, FAZ II Plus R, FAZ II Plus HCR						Annex C8		
Performances Characteristic values of resistance under tension and shear loads under seismic action category C2								

Table C9.1: Displacements under static and quasi static **tension** loads

Size	FAZ II Plus, FAZ II Plus R, FAZ II Plus HCR						
	M6	M8	M10	M12	M16	M20	M24
Displacement – factor for tensile load¹⁾							
δ_{N0} - factor	0,13	0,22	0,12	0,09	0,08	0,07	0,05
in cracked concrete							
$\delta_{N\infty}$ - factor	1,00	0,78	0,40	0,19	0,09		0,07
[mm/kN]							
δ_{N0} - factor	0,16	0,07	0,05	0,06		0,05	0,04
in uncracked concrete							
$\delta_{N\infty}$ - factor	0,24	0,29	0,21	0,14	0,10	0,06	0,05

Table C9.2: Displacements under static and quasi static **shear** loads

Size	FAZ II Plus, FAZ II Plus R, FAZ II Plus HCR						
	M6	M8	M10	M12	M16	M20	M24
Displacement – factor for shear load²⁾							
FAZ II Plus							
δ_{V0} - factor	0,6	0,35	0,37	0,27	0,10	0,09	0,07
$\delta_{V\infty}$ - factor	0,9	0,52	0,55	0,40	0,14	0,15	0,11
in cracked or uncracked concrete							
[mm/kN]							
FAZ II Plus R, FAZ II Plus HCR							
δ_{V0} - factor	0,6	0,23	0,19	0,18	0,10	0,11	0,07
$\delta_{V\infty}$ - factor	0,9	0,35	0,29	0,27	0,15	0,17	0,11

¹⁾ Calculation of effective displacement:

$$\delta_{N0} = \delta_{N0} - \text{factor} \cdot N$$

$$\delta_{N\infty} = \delta_{N\infty} - \text{factor} \cdot N$$

N = Action tension loading

²⁾ Calculation of effective displacement:

$$\delta_{V0} = \delta_{V0} - \text{factor} \cdot V$$

$$\delta_{V\infty} = \delta_{V\infty} - \text{factor} \cdot V$$

V = Action shear loading

Table C9.3: Displacements under **tension** loads for **category C2** for all embedment depths

Size	FAZ II Plus, FAZ II Plus R, FAZ II Plus HCR						
	M6	M8	M10	M12	M16	M20	M24
DLS $\delta_{N,C2(DLS)}$ [mm]	- ¹⁾		2,7	4,4		5,6	4,8
ULS $\delta_{N,C2(ULS)}$ [mm]	- ¹⁾		11,5	13,0	12,3	14,4	15,2

¹⁾ No performance assessed

Table C9.4: Displacements under **shear** loads for **category C2** for all embedment depths

Size	FAZ II Plus, FAZ II Plus R, FAZ II Plus HCR						
	M6	M8	M10	M12	M16	M20	M24
DLS without filling $\delta_{V,C2(DLS)}$	- ¹⁾		5,0			4,8	4,2
ULS without filling $\delta_{V,C2(ULS)}$	- ¹⁾		7,8	6,3	8,8	6,3	7,4
DLS with filling $\delta_{V,C2(DLS)}$	- ¹⁾		1,2			2,0	4,2
ULS with filling $\delta_{V,C2(ULS)}$	- ¹⁾		4,2	5,8	3,1	4,4	7,4

¹⁾ No performance assessed

fischer Bolt Anchor FAZ II Plus, FAZ II Plus R, FAZ II Plus HCR	Annex C9
Performances Displacements under tension and shear loads	