

Approval body for construction products
and types of construction

Bautechnisches Prüfamt

An institution established by the Federal and
Laender Governments



European Technical Assessment

ETA-10/0168
of 11 May 2022

English translation prepared by DIBt - Original version in German language

General Part

Technical Assessment Body issuing the
European Technical Assessment:

Deutsches Institut für Bautechnik

Trade name of the construction product

Upat Drop-in Anchor USA

Product family
to which the construction product belongs

Fasteners for use in concrete for
redundant non-structural systems

Manufacturer

Upat Vertriebs GmbH
Bebelstraße 11
79108 Freiburg im Breisgau
DEUTSCHLAND

Manufacturing plant

Upat

This European Technical Assessment
contains

15 pages including 3 annexes which form an integral part
of this assessment

This European Technical Assessment is
issued in accordance with Regulation (EU)
No 305/2011, on the basis of

EAD 330747-00-0601, Edition 06/2018

This version replaces

ETA-10/0168 issued on 11 May 2017

The European Technical Assessment is issued by the Technical Assessment Body in its official language. Translations of this European Technical Assessment in other languages shall fully correspond to the original issued document and shall be identified as such.

Communication of this European Technical Assessment, including transmission by electronic means, shall be in full. However, partial reproduction may only be made with the written consent of the issuing Technical Assessment Body. Any partial reproduction shall be identified as such.

This European Technical Assessment may be withdrawn by the issuing Technical Assessment Body, in particular pursuant to information by the Commission in accordance with Article 25(3) of Regulation (EU) No 305/2011.

Specific Part

1 Technical description of the product

The Upat drop-in anchor USA is an anchor made of galvanised or stainless steel which is placed into a drilled hole and anchored by deformation-controlled expansion.

The fixture shall be anchored with a fastening screw or threaded rod according to Annex B 5.

The product description is given in Annex A.

2 Specification of the intended use in accordance with the applicable European Assessment Document

The performances given in Section 3 are only valid if the anchor is used in compliance with the specifications and conditions given in Annex B.

The verifications and assessment methods on which this European Technical Assessment is based lead to the assumption of a working life of the anchor of at least 50 years. The indications given on the working life cannot be interpreted as a guarantee given by the producer, but are to be regarded only as a means for choosing the right products in relation to the expected economically reasonable working life of the works.

3 Performance of the product and references to the methods used for its assessment

3.1 Safety in case of fire (BWR 2)

Essential characteristic	Performance
Reaction to fire	Class A1
Resistance to fire	See Annex C 3

3.2 Safety and accessibility in use (BWR 4)

Essential characteristic	Performance
Characteristic resistance for all load directions and modes of failure for simplified design	See Annex C 1 and C 2
Durability	See Annex B 1

4 Assessment and verification of constancy of performance (AVCP) system applied, with reference to its legal base

In accordance with European Assessment Document EAD No. 330747-00-0601, the applicable European legal act is: [97/161/EC].

The system to be applied is: 2+

5 Technical details necessary for the implementation of the AVCP system, as provided for in the applicable European Assessment Document

Technical details necessary for the implementation of the AVCP system are laid down in the control plan deposited with Deutsches Institut für Bautechnik.

Issued in Berlin on 11 May 2022 by Deutsches Institut für Bautechnik

Dipl.-Ing. Beatrix Wittstock
Head of Section

beglaubigt:
Baderschneider

Only for use for redundant non-structural systems according to EN 1992-4:2018

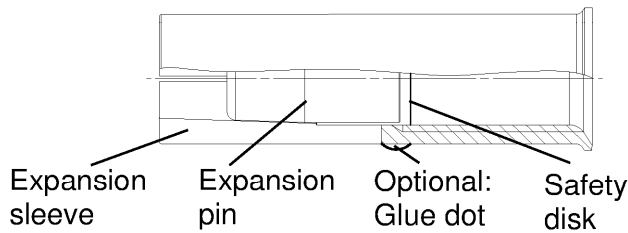
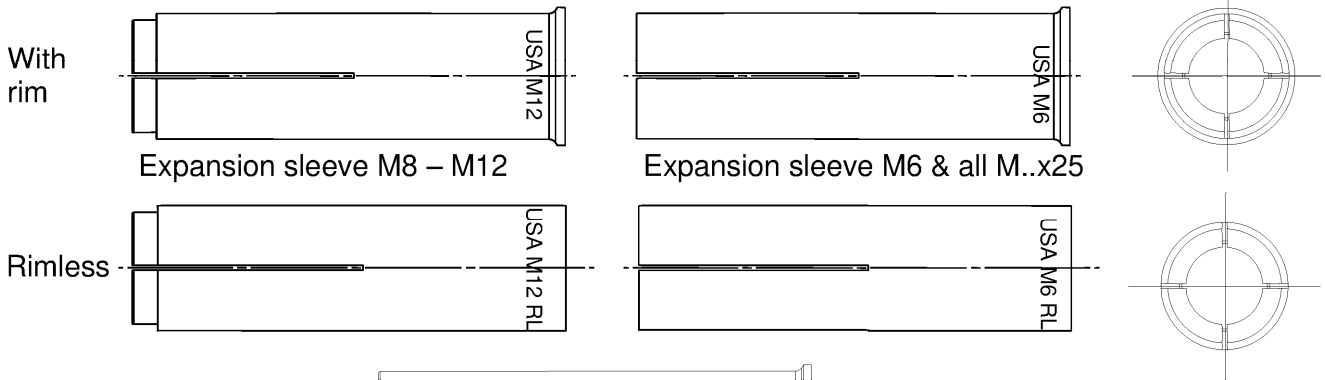

Intended use in concrete

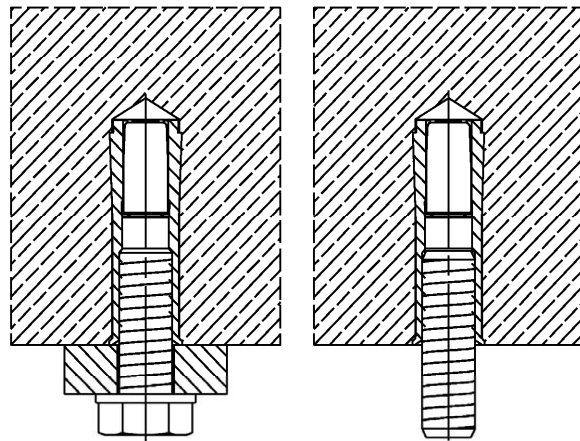

Intended use in precast pre-stressed hollow concrete slabs ($w/e \leq 4,2$) with a flange thickness $d_b \geq 35$ mm (or 30 mm → see Annex C2) and only for $h_{ef} = 25$ mm

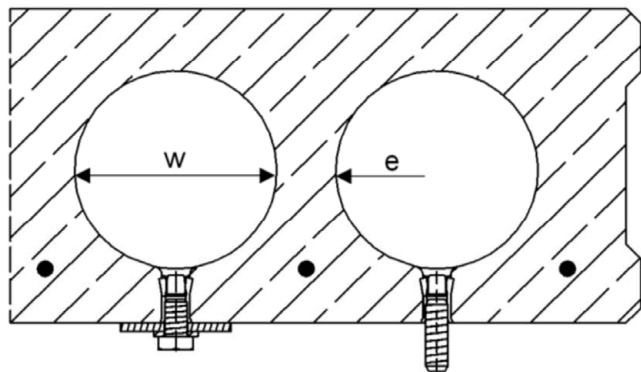

(Fig. not to scale)

Upat drop-in anchor USA

Product description
Installed condition
Anchor types

Annex A 1

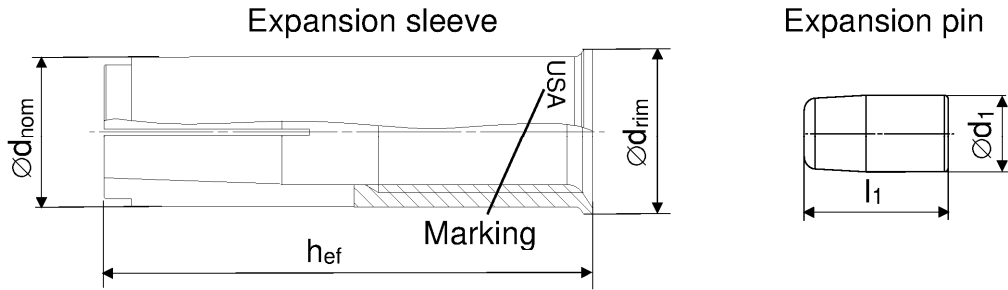

Table A2.1: Anchor size

Anchor size USA [mm]	M6x25	M6x30	M8x25	M8x30	M8x40	M10x25	M10x30	M10x40	M12x25	M12x50	M12 D
h_{ef}	25	30	25	30	40	25	30	40	25	50	50
$\varnothing d_{nom}$	8		10			12			15		16
$\varnothing d_{rim}$ (not applicable for USA RL)	9,5		11,5			13,5			16,5		17,5
$\varnothing d_1$	5		6,5			8,5	8		10		
l_1	9	14	8	13,5		9	13,5	18,5	10,5	18,5	

Distinctive feature

No groove for:

- USA M6x30..
- USA M8x30..
- USA M10x40..
- USA M12x50..

1 groove for:

- USA M6x25..
- USA M8x25..
- USA M10x25..
- USA M12x25..

2 grooves for:

- USA M8x40..
- USA M10x30..

Table A2.2: Marking on anchor body

galvanised steel (gvz)		stainless steel (R)	
with rim	rimless	with rim	rimless
USA M6x25	USA M6x25 RL	USA M6x30 R	USA M6x30 RL R
USA M6x30	USA M6x30 RL	USA M8x30 R	USA M8x30 RL R
USA M8x25	USA M8x25 RL	USA M8x40 R	USA M8x40 RL R
USA M8x30	USA M8x30 RL	USA M10x30 R	USA M10x30 RL R
USA M8x40	USA M8x40 RL	USA M10x40 R	USA M10x40 RL R
USA M10x25	USA M10x25 RL	USA M12x50 R	USA M12x50 RL R
USA M10x30	USA M10x30 RL	USA M12x50 D R	USA M12x50 RL D R
USA M10x40	USA M10x40 RL		
USA M12x25	USA M12x25 RL		
USA M12x50	USA M12x50 RL		
USA M12x50 D	USA M12x50 RL D		

(Fig. not to scale)

Upat drop-in anchor USA

Product description
Anchor types

Annex A 2

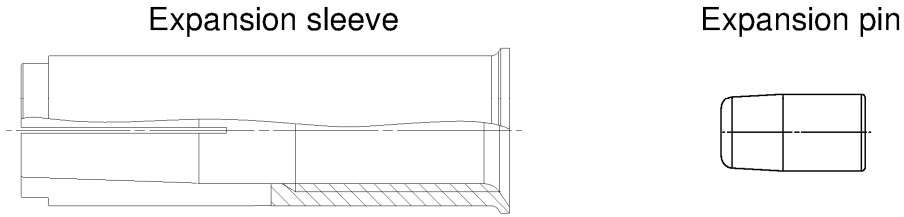

Table A3.1: Materials

Designation	Material	
	galvanised steel ($\geq 5 \mu\text{m}$)	stainless steel (R)
Expansion sleeve	EN 10277:2018 or EN 10084:2008 or EN 10111:2008 or EN 10263:2018 or EN 10087:1999 or ASTM A29/A29M	EN 10088:2014
Expansion pin		
Fastening screw or threaded rod	steel, property class 4.6, 5.6, 5.8 or 8.8 according to EN ISO 898-1:2013	property class 50, 70 or 80 according EN ISO 3506:2020

Electronic copy of the ETA by DIBt: ETA-10/0168

Upat drop-in anchor USA

Product description
Materials

Annex A 3

Setting & drilling tools

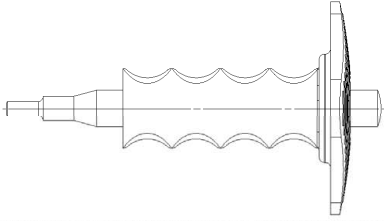
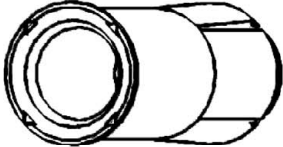
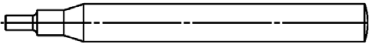
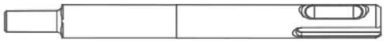
Setting tools	Marking	Description	Marking on USA with rim and rimless
	EHS Plus M..x hef	Manual setting tool with hand guard	
	EHS M..x hef	Manual setting tool basic format	
	EMS M..x hef	Machine setting tool with SDS Plus	No marking

Drilling tools

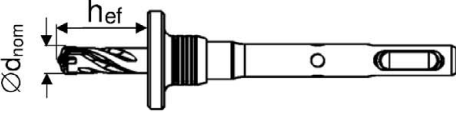
	EBB Ødnom X hef	Stop drill
Or other usual drillers		

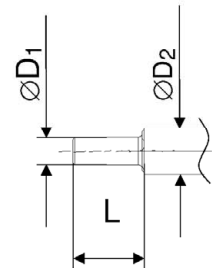

Table A4.1: Corresponding drill bits and parameters of setting tools

Manual setting tool	Machine setting tool	Stop drill	For anchor size	Ø D1 [mm]	Ø D2 [mm]	L [mm]
EHS (Plus) M6x25/30	EMS M6x25/30	EBB 8x25 EBB 8x30	USA M6x25 USA M6x30	4,8	9,0	17,0
EHS (Plus) M8x25/30	EMS M8x25/30	EBB 10x25 EBB 10x30	USA M8x25 USA M8x30	6,4	11,0	18,0
EHS (Plus) M8x40	EMS M8x40	EBB 10x40	USA M8x40			28,0
EHS (Plus) M10x25/30	EMS M10x25/30	EBB 12x25 EBB 12x30	USA M10x25 USA M10x30	7,9	13,0	18,0
EHS (Plus) M10x40	EMS M10x40	EBB 12x40	USA M10x40			24,0
EHS (Plus) M12x25	EMS M12x25	EBB 15x25	USA M12x25	10,2	16,5	15,2
EHS (Plus) M12x50	EMS M12x50	EBB 15x50	USA M12x50	10,2	16,5	30,0
EHS (Plus) M12x50	EMS M12x50	EBB 16x50	USA M12x50 D			

(Fig. not to scale)

Upat drop-in anchor USA

Intended Use
Setting & Drilling tools

Annex A 4



Specifications of intended use				
Anchorage subject to:				
Upat drop-in anchor USA (all versions)	M6	M8	M10	M12
Hammer drilling with standard drill bit 	All types			
Hammer drilling with hollow drill bit with automatic cleaning 				
Material	Steel	Zinc plated	✓	
	Stainless steel	R		
Static and quasi-static loads				
Cracked and uncracked concrete				
Fire exposure in concrete C12/15 to C50/60				
Fire exposure in prestressed hollow concrete slabs	No performance assessed			
Base materials:				
<ul style="list-style-type: none"> • Compacted reinforced and unreinforced normal weight concrete without fibres (cracked and uncracked) according to EN 206:2013+A1:2016 • Strength classes C12/15 to C50/60 according to EN 206:2013+A1:2016 • Precast prestressed hollow concrete slabs with $w/e \leq 4,2$ and strength classes C30/37 to C50/60: M6x25, M8x25, M10x25 and M12x25 				
Use conditions (Environmental conditions):				
<ul style="list-style-type: none"> • Structures subject to dry internal conditions: USA, USA R • For all other conditions according to EN 1993-1-4:2006 + A1:2015 corresponding to corrosion resistance class CRC III USA R with $h_{ef} \geq 30$ mm 				
Design:				
<ul style="list-style-type: none"> • Anchorages are designed under the responsibility of an engineer experienced in anchorages and concrete work • Verifiable calculation notes and drawings are prepared taking account of the loads to be anchored. The position of the anchor is indicated on the design drawings (e. g. position of the anchor relative to reinforcement or to supports, etc.) • Only for use for redundant non-structural system according to EN 1992-4:2018, Chapter 7.3. Design Method B according to EN 1992-4:2018. • Anchorages under fire exposure are designed according to EN 1992-4:2018 Annex D 				
Installation:				
<ul style="list-style-type: none"> • Anchor installation carried out by appropriately qualified personnel and under the supervision of the person responsible for technical matters of the site • Create drill hole with hammer drill or with hollow drill and vacuum cleaner • The anchor may only be used once • In case of aborted hole: New hole must be drilled at a minimum distance of twice the depth of the aborted hole or closer, if the hole is filled with a high strength mortar (e.g. UPM 66, UPM 55 or UPM 44) and only if the hole is not in the direction of the oblique tensile or shear load • Anchor expansion by impact using the setting tools given in Annex A 4. The anchor is properly set, if the stop of the setting tool reaches the expansion sleeve. The manual setting tool with installation control leaves a visible mark on the sleeve, as illustrated in Annex A 4 and B 4 				
Upat drop-in anchor USA				Annex B 1
Intended Use Specifications				

Table B2.1: Installation parameters for concrete C12/15 to C50/60

Anchor size (all versions)			M6			M8			M10			M12		M12D
Nominal drill hole diameter	d_0	[mm]	8			10			12			15		16
Effective anchorage depth	h_{ef}	[mm]	25	30	25	30	40	25	30	40	25	50	50	
Maximum installation torque	$T_{inst,max}$	[Nm]	4			8			15			35		
Minimum drill hole depth	h_1	[mm]	27	32	27	33	43	27	33	43	27	54	54	
Minimum screw-in depth	$l_{s,min}$	[mm]	6			8			10			12		
Maximum screw-in depth	$l_{s,max}$	[mm]	14			14			14	15	17	14	22	
Clearance hole diameter	$\varnothing d_f \leq$	[mm]	7			9			12			14		
$h_{min} = 80$ mm														
Minimum spacing	s_{min}	[mm]	30	70	70	110	200	80	200		100	-	-	
Minimum edge distance	c_{min}	[mm]	60	150	100	150		120	150		130	-	-	
$h_{min} = 100$ mm														
Minimum spacing	s_{min}	[mm]	30	65	50	70		60	90	150	100	200		
Minimum edge distance	c_{min}	[mm]	60	115	100	115		100	160	180	110	200		
$h_{min} = 120$ mm														
Minimum spacing	s_{min}	[mm]	30	65	50	70		60	85	95	100	145		
Minimum edge distance	c_{min}	[mm]	60	115	100	115		100	140	150	110	200		

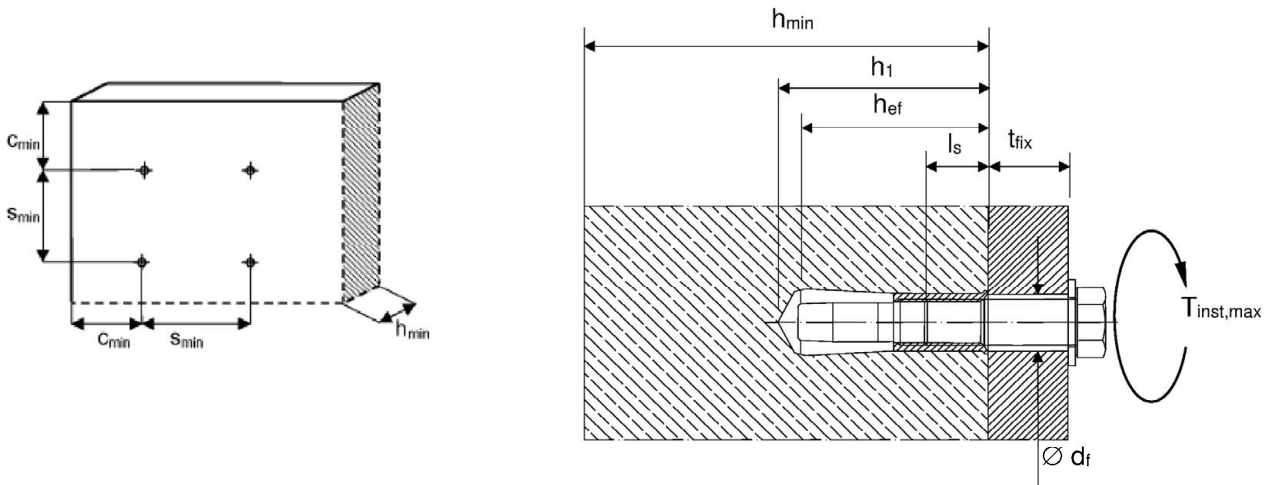

Fastening screw or threaded rod:

- Minimum property class and materials according to table A3.1
- The length of the fastening screw or threaded rod shall be determined depending on thickness of fixture t_{fix} , admissible tolerances and maximum screw-in depth $l_{s,max}$ as well as minimum screw-in depth $l_{s,min}$.

(Fig. not to scale)

Upat drop-in anchor USA	Annex B 2
Intended Use Installation parameters	

Table B3.1: Installation parameters for precast pre-stressed hollow concrete slabs

Anchor size (all versions)			M6	M8	M10	M12
Nominal drill hole diameter	d_0	[mm]	8	10	12	15
Effective anchorage depth	h_{ef}	[mm]	25			
Maximum installation torque	$T_{inst,max}$	[Nm]	4	8	15	35
Minimum drill hole depth	h_1	[mm]	27			
Minimum screw-in depth	$l_{s,min}$	[mm]	6	8	10	12
Maximum screw-in depth	$l_{s,max}$	[mm]	14			
Clearance hole diameter	$\varnothing d_f$	[mm]	7	9	12	14
Minimum spacing	$S_{min} = S_{cr}$	[mm]	200			
Minimum edge distance	$C_{min} = C_{cr}$	[mm]	150			

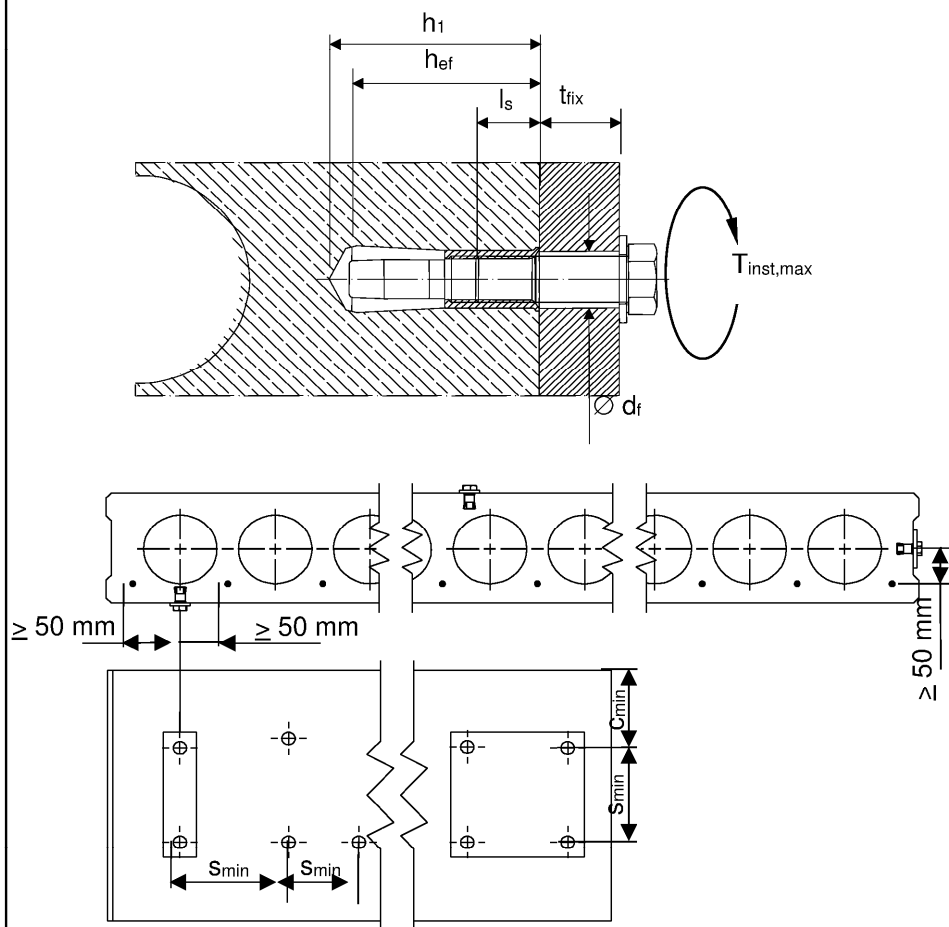

Fastening screw or threaded rod:

- Minimum property class and materials according to table A3.1
- The length of the fastening screw or threaded rod shall be determined depending on thickness of fixture t_{fix} , admissible tolerances and maximum screw-in depth $l_{s,max}$ as well as minimum screw-in depth $l_{s,min}$.

(Fig. not to scale)

Upat drop-in anchor USA

Intended Use
Installation parameters

Annex B 3

Installation instructions

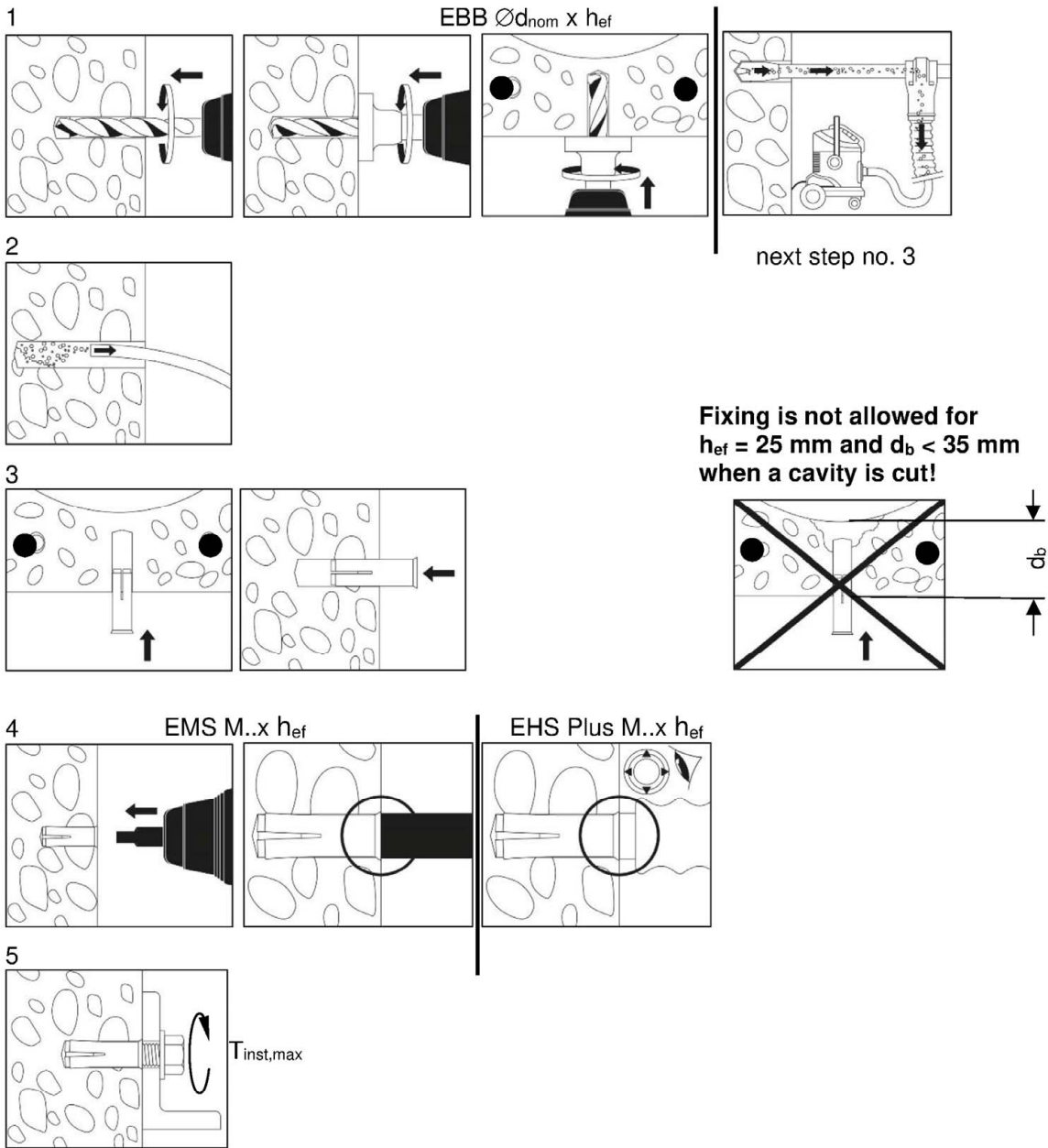

No.	Description
1	Create drill hole with hammer drill or stop drill or with hollow drill and vacuum cleaner
2	Clean from drill-dust
3	Set anchor till anchor is flush with surface of concrete
4	Expand the sleeve by driving the pin with the corresponding setting tool into the sleeve and control the correct setting
5	Fixation of fixture. Maximum installation torque $T_{\text{inst,max}}$ must not be exceeded

(Fig. not to scale)

Upat drop-in anchor USA

Intended Use
Installation instructions

Annex B 4

Table C1.1: Characteristic resistance of a fixing point¹⁾ for all load directions

Anchor size		property class of the fastening screw or threaded rod	M6		M8			M10			M12/M12D	
Effective anchorage depth	h_{ef} [mm]		25	30	25	30	40	25	30	40	25	50
All load directions												
Characteristic resistance C12/15	F^{0}_{RK} [kN]	\geq A4-50	⁻²⁾	2	⁻²⁾	3		⁻²⁾	3	5	⁻²⁾	6
		\geq steel 4.6	1,5		2			3			3	
Characteristic resistance C20/25 to C50/60	F^{0}_{RK} [kN]	\geq A4-50	⁻²⁾	3	⁻²⁾	5		⁻²⁾	5	7,5	⁻²⁾	9
		\geq steel 4.6	2		3			4			4	
Installation factor	γ_{inst} [-]		1,0	1,2	1,0	1,2		1,0	1,2		1,0	
Characteristic spacing	s_{cr} [mm]		75	90	75	90	120	75	90	200	75	300
Characteristic edge distance	c_{cr} [mm]		38	45	38	45	60	38	45	100	38	150
Steel failure with lever arm												
Characteristic resistance	$M^{0}_{RK,s}$ [Nm]	A4-50	⁻²⁾	8	⁻²⁾	19		⁻²⁾	37		⁻²⁾	66
Partial factor	$\gamma_{Ms}^{3)}$ [-]		2,38									
Characteristic resistance	$M^{0}_{RK,s}$ [Nm]	A4-70	⁻²⁾	11	⁻²⁾	26		⁻²⁾	52		⁻²⁾	92
Partial factor	$\gamma_{Ms}^{3)}$ [-]		1,56									
Characteristic resistance	$M^{0}_{RK,s}$ [Nm]	A4-80	⁻²⁾	12	⁻²⁾	30		⁻²⁾	60		⁻²⁾	105
Partial factor	$\gamma_{Ms}^{3)}$ [-]		1,33									
Characteristic resistance	$M^{0}_{RK,s}$ [Nm]	steel 4.6	6,1		15		30		52			
Partial factor	$\gamma_{Ms}^{3)}$ [-]		1,67									
Characteristic resistance	$M^{0}_{RK,s}$ [Nm]	steel 5.6	7,6		19		37		66			
Partial factor	$\gamma_{Ms}^{3)}$ [-]		1,67									
Characteristic resistance	$M^{0}_{RK,s}$ [Nm]	steel 5.8	7,6		19		37		66			
Partial factor	$\gamma_{Ms}^{3)}$ [-]		1,25									
Characteristic resistance	$M^{0}_{RK,s}$ [Nm]	steel 8.8	12		30		60		105			
Partial factor	$\gamma_{Ms}^{3)}$ [-]		1,25									
1) For definition see EN 1992-4:2018, Picture 3.4												
2) No performance assessed												
3) In absence of other national regulations												
Upat drop-in anchor USA										Annex C 1		
Performances Characteristic values for tension loads in concrete according to design method B												

Table C2.1: Characteristic values for $h_{ef} = 25$ mm in precast pre-stressed hollow concrete slabs according to design method C with C30/37 to C50/60

Anchor size		property class of the fastening screw or threaded rod	M6	M8	M10	M12
Effective anchorage depth	h_{ef} [mm]			25		
All Load directions			galvanised steel; with rim			
Flange thickness	d_b [mm]		≥ 35 (or 30 ¹⁾)			
Characteristic resistance C30/37 to C50/60	F^{0}_{RK} [kN]		2	3	4	
Installation factor	γ_{inst} [-]		1,0			
Characteristic spacing	$s_{cr} = s_{min}$ [mm]		200			
Characteristic edge distance	$c_{cr} = c_{min}$ [mm]		150			
Steel failure with lever arm						
Characteristic resistance	$M^{0}_{RK,s}$ [Nm]	steel 4.6	6,1	15	30	52
Partial factor	$\gamma_{Ms^{2)}$ [-]		1,67			
Characteristic resistance	$M^{0}_{RK,s}$ [Nm]	steel 5.6	7,6	19	37	66
Partial factor	$\gamma_{Ms^{2)}$ [-]		1,67			
Characteristic resistance	$M^{0}_{RK,s}$ [Nm]	steel 5.8	7,6	19	37	66
Partial factor	$\gamma_{Ms^{2)}$ [-]		1,25			
Characteristic resistance	$M^{0}_{RK,s}$ [Nm]	steel 8.8	12	30	60	105
Partial factor	$\gamma_{Ms^{2)}$ [-]		1,25			

¹⁾ The anchor may be used in a flange thickness d_b of minimum 30 mm with the same characteristic resistance, but the drill hole is not allowed to cut a cavity (see Annex B 4 Point 3). The use of the fischer stop drill EBB is recommended

²⁾ In absence of other national regulations

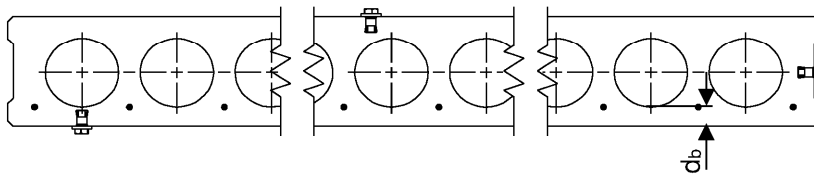

(Fig. not to scale)

Upat drop-in anchor USA

Performances
Characteristic values for tension loads in hollow core slabs according to design method C with C30/37 to C50/60

Annex C 2

Table C3.1: Characteristic resistance under fire exposure³⁾ in concrete C20/25 to C50/60

fire resistance class	USA	property class of the fastening screw or threaded rod	M6x25	M6x30	M8x25	M8x30	M8x40	M10x25	M10x30	M10x40	M12x25	M12x50/ M12x50D
			All load directions									
R 30	Characteristic resistance C20/25 to C50/60	steel ≥ 4.6 or $\geq A4-50^{2)}$	0,5	0,6	0,9	1,3	0,6	0,9	1,8	0,6	2,3	
R 60			0,5	0,6	0,9	1,5						
R 90			0,4	0,6		0,9	2,0					
R 120			0,3	0,5		0,6	0,5	1,3				
R 30 – R 120	Characteristic spacing	$s_{cr,fi}$ [mm]	100	120	100	120	160	100	120	160	100	200
	Characteristic edge distance	$c_{cr,fi}$ [mm]	50	115	50	140	140	50	140	160	50	

¹⁾ In absence of other national regulations, a partial factor for the resistance of $\gamma_{m,fi} = 1,0$ under fire impact is recommended.

²⁾ Not for M..x25

³⁾ Not valid for precast pre-stressed hollow core slabs

Table C3.2: Characteristic resistance under fire exposure³⁾ for shear load with level arm in concrete C20/25 to C50/60

fire resistance class	USA	property class of the fastening screw or threaded rod	M6x25	M6x30	M8x25	M8x30	M8x40	M10x25	M10x30	M10x40	M12x25	M12x50/ M12x50D
			R 30	Characteristic resistance	steel ≥ 4.6 or $\geq A4-5^{2)}$	0,65	0,5	1,30	1,7	1,7	2,4	4,4
R 60	0,50	0,4	0,95			1,3	1,3	1,7	3,2	3,2	5,0	6,7
R 90	0,35	0,3	0,60			0,8	0,8	1,0	1,9	1,9	2,9	3,9
R 120	0,30	0,2	0,45			0,6	0,6	0,7	1,3	1,3	1,8	2,4

¹⁾ In absence of other national regulations, a partial factor for the resistance of $\gamma_{m,fi} = 1,0$ under fire impact is recommended.

²⁾ Not for M..x25

³⁾ Not valid for precast pre-stressed hollow core slabs

In case of fire attack from more than one side, the edge distance shall be $c_{fi,min} \geq 300$ mm

Upat drop-in anchor USA

Performances
Characteristic loads for fire resistances

Annex C 3