

PRESTANDEKLARATION

DoP 0196

för fischer RM II (Metallankare för användning i betong)

SV

1. <u>Produkttypens unika identifikationskod:</u>	DoP 0196		
2. <u>Avsedd användning/avsedda användningar:</u>	Infästning i efterhand i sprucken och osprucken betong. Se bilaga, särskilt bilagor B1- B7		
3. <u>Tillverkare:</u>	fischerwerke GmbH & Co. KG, Otto-Hahn-Straße 15, 79211 Denzlingen, Tyskland		
4. <u>Tillverkarens representant:</u>	–		
5. <u>System för bedömning och fortlöpande kontroll av prestanda:</u>	1		
6. <u>Europeiskt bedömningsdokument:</u>	EAD 330499-01-0601 ETA-16/0340; 2020-06-17 DIBt- Deutsches Institut für Bautechnik 1343 MPA Darmstadt / 2873 TU Darmstadt		
7. <u>Angiven prestanda:</u>			
Mekanisk hållfasthet och stabilitet (BWR 1)			
Karakteristisk bärförmåga för spänning (för statisk och kvasi-statisk belastning):	Stålets motståndskraft: Motstånd mot kombinerat fel vid utdragning och betongkon: Motstånd i betongkonen: Kantavstånd för att slippa sprickor under last:	Bilagor C1, C2 Bilagor C4, C5 Bilagor C3 Bilagor C3	$\tau_{Rk,100} = \text{NPD}$ $\psi_{sUS} = \text{NPD}$
Karakteristisk bärförmåga för skjuvning (för statisk och kvasi-statisk belastning):	Kraftighet: Maximal vridkraft vid installation: Minsta kant- och axelavstånd:	Bilagor C3- C5 Bilagor B3, B4 Bilagor B3, B4	
	Motstånd i stålet: Motstånd mot fläkning: Motstånd mot skador i betong:	Bilagor C1, C2 Bilagor C3 Bilagor C3	
Karakteristiskt motstånd och Förskjutningar för seismiska prestandakategorier C1 och C2:	Motstånd mot draglast, förskjutningar, kategori C1: Motstånd mot draglast, förskjutningar, kategori C2: Motstånd mot tvärlast, förskjutningar, kategori C1: Motstånd mot tvärlast, förskjutningar, kategori C2: Faktor cirkulärt hål:	NPD NPD NPD NPD NPD	
Förflyttningar under kort- och långvarig belastning:	Förflyttningar under kort- och långvarig belastning:	Bilagor C6	
Hygien, hälsa och miljö (BWR 3)			
Innehåll, frisläppning och / eller frisläppning av farliga ämnen:	NPA		



8. Lämplig teknisk dokumentation och/eller särskild teknisk dokumentation: -

Prestandan för ovanstående produkt överensstämmer med den angivna prestandan. Denna prestandadeklaration har utfärdats i enlighet med förordning (EU) nr 305/2011 på eget ansvar av den tillverkare som anges ovan.

Undertecknad på tillverkarens vägnar av:

Thilo Pregartner, Dr.-Ing.
Tumlingen, 2020-07-01

Peter Schillinger, Dipl.-Ing.

Denna DoP har förberetts på olika språk. I händelse av tvist om tolkningen ska den engelska versionen alltid råda.

Bilagan innehåller frivilliga och kompletterande information på engelska som överskrider (det specifika språkets) lagkrav.

Specific Part

1 Technical description of the product

The fischer capsule system RM II is a bonded anchor for use in concrete consisting of a capsule RM II and a steel element according to Annex A2.

The capsule RM II is placed in the hole and the steel element is driven by machine with simultaneous hammering and turning.

The anchor rod is anchored via the bond between steel element, chemical mortar and concrete.

The product description is given in Annex A.

2 Specification of the intended use in accordance with the applicable European Assessment Document

The performances given in Section 3 are only valid if the anchor is used in compliance with the specifications and conditions given in Annex B.

The verifications and assessment methods on which this European Technical Assessment is based lead to the assumption of a working life of the anchor of at least 50 years. The indications given on the working life cannot be interpreted as a guarantee given by the producer, but are to be regarded only as a means for choosing the right products in relation to the expected economically reasonable working life of the works.

3 Performance of the product and references to the methods used for its assessment

3.1 Mechanical resistance and stability (BWR 1)

Essential characteristic	Performance
Characteristic resistance to tension load (static and quasi-static loading)	See Annex B 3 and B 4, C 1 to C 5
Characteristic resistance to shear load (static and quasi-static loading)	See Annex C 1 to C 4
Displacements under short-term and long-term loading	See Annex C 6
Characteristic resistance and displacements for seismic performance categories C1 and C2	No performance assessed

3.2 Hygiene, health and the environment (BWR 3)

Essential characteristic	Performance
Content, emission and/or release of dangerous substances	No performance assessed

4 Assessment and verification of constancy of performance (AVCP) system applied, with reference to its legal base

In accordance with the European Assessment Document EAD 330499-01-0601 the applicable European legal act is: [96/582/EC].

The system to be applied is: 1

Installation conditions

fischer anchor rod RG M; installation in concrete

Pre-positioned installation:

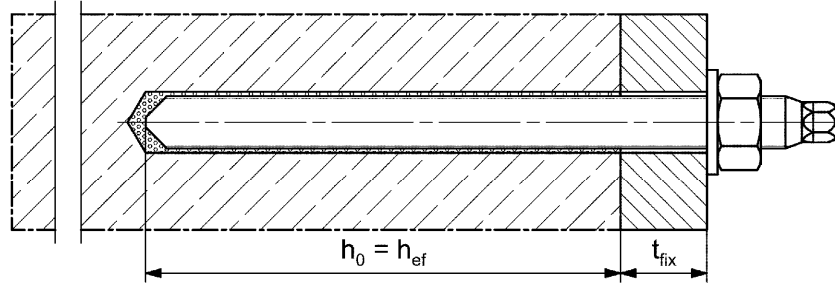

Pre-positioned installation with subsequently injected fischer filling disc:

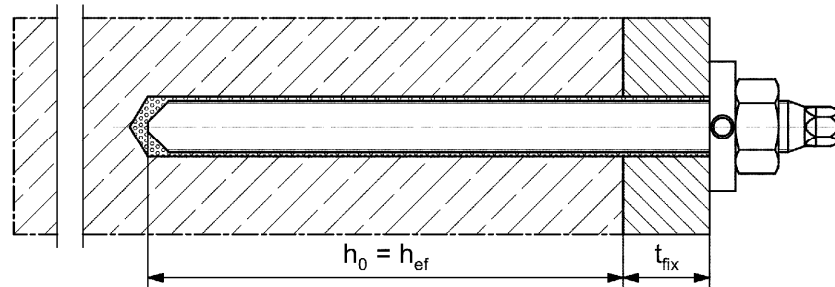

fischer internal threaded anchor RG M I; installation in concrete

Pre-positioned installation:

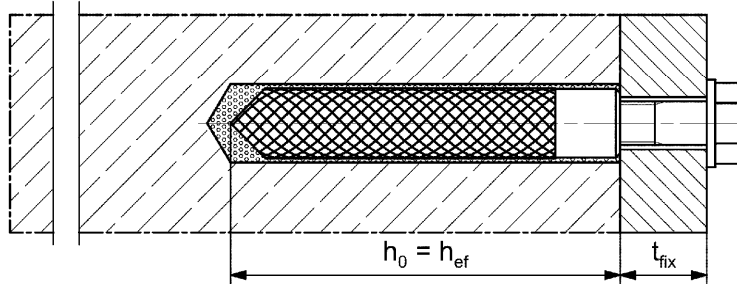

Pre-positioned installation with subsequently injected fischer filling disc:

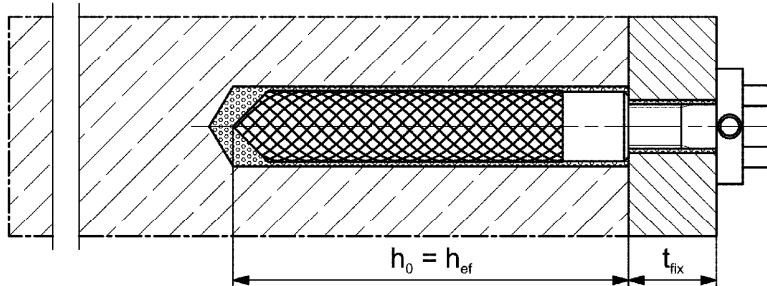

Pictures not to scale

h_0 = drill hole depth

h_{ef} = effective anchorage depth

t_{fix} = thickness of fixture

fischer RM II

Product description
Installation conditions

Annex A 1

Appendix 3/ 18

Overview product components

Capsule RM II

Size: 8, 10, 12, 16, 16E, 20/22, 24



fischer anchor rod RG M

Size: M8, M10, M12, M16, M20, M24

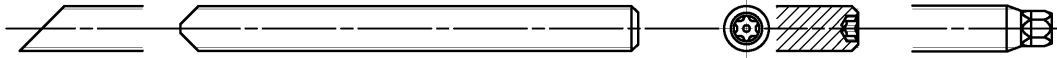

fischer internal threaded anchor RG M I

Size: M8, M10, M12, M16, M20

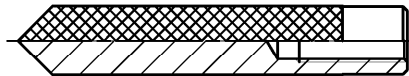

Screw / threaded rod / washer / hexagon nut

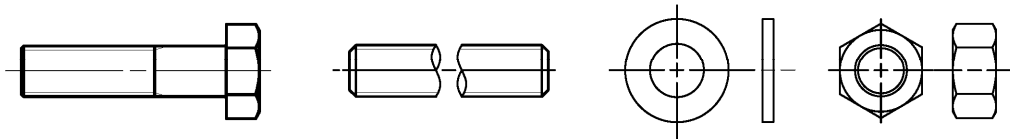

fischer filling disc with injection adapter

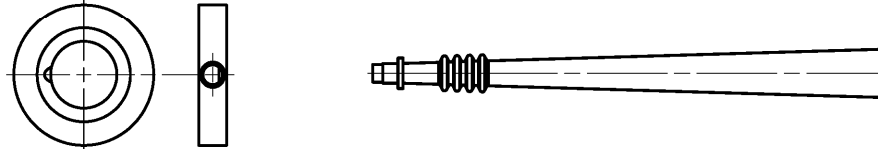

Pictures not to scale

fischer RM II

Product description
Overview product components

Annex A 2

Appendix 4/ 18

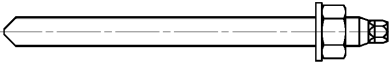
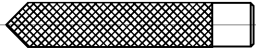

Table A3.1: Materials

Part	Designation	Material		
1	Capsule RM II	Mortar, hardener, filler		
	Steel grade	Steel	Stainless steel R	High corrosion resistant steel HCR
		zinc plated	acc. to EN 10088-1:2014 Corrosion resistance class CRC III acc. to EN 1993-1-4:2015	acc. to EN 10088-1:2014 Corrosion resistance class CRC V acc. to EN 1993-1-4:2015
2	Anchor rod	Property class 4.8, 5.8 or 8.8; EN ISO 898-1:2013 zinc plated $\geq 5 \mu\text{m}$, ISO 4042:2018/Zn5/An(A2K) or hot dip galvanised $\geq 40 \mu\text{m}$ EN ISO 10684:2004 $f_{uk} \leq 1000 \text{ N/mm}^2$	Property class 50, 70 or 80 EN ISO 3506-1:2009 1.4401; 1.4404; 1.4578; 1.4571; 1.4439; 1.4362; 1.4062, 1.4662, 1.4462 EN 10088-1:2014 $f_{uk} \leq 1000 \text{ N/mm}^2$	Property class 50 or 80 EN ISO 3506-1:2009 or property class 70 with $f_{yk} = 560 \text{ N/mm}^2$ 1.4565; 1.4529 EN 10088-1:2014 $f_{uk} \leq 1000 \text{ N/mm}^2$
		Fracture elongation $A_5 > 8 \%$,		
3	Washer ISO 7089:2000	zinc plated $\geq 5 \mu\text{m}$, ISO 4042:2018/Zn5/An(A2K) or hot dip galvanised $\geq 40 \mu\text{m}$ EN ISO 10684:2004	1.4401; 1.4404; 1.4578; 1.4571; 1.4439; 1.4362 EN 10088-1:2014	1.4565; 1.4529 EN 10088-1:2014
4	Hexagon nut	Property class 4, 5 or 8; EN ISO 898-2:2012 zinc plated $\geq 5 \mu\text{m}$, ISO 4042:2018/Zn5/An(A2K) or hot dip galvanised $\geq 40 \mu\text{m}$ EN ISO 10684:2004	Property class 50, 70 or 80 EN ISO 3506-1:2009 1.4401; 1.4404; 1.4578; 1.4571; 1.4439; 1.4362 EN 10088-1:2014	Property class 50, 70 or 80 EN ISO 3506-1:2009 1.4565; 1.4529 EN 10088-1:2014
5	fischer internal threaded anchor RG M I	Property class 5.8 ISO 898-1:2013 zinc plated $\geq 5 \mu\text{m}$, ISO 4042:2018/Zn5/An(A2K)	Property class 70 EN ISO 3506-1:2009 1.4401; 1.4404; 1.4578; 1.4571; 1.4439; 1.4362 EN 10088-1:2014	Property class 70 EN ISO 3506-1:2009 1.4565; 1.4529 EN 10088-1:2014
6	Commercial standard screw or threaded rod for fischer internal threaded anchor RG M I	Property class 5.8 or 8.8; EN ISO 898-1:2013 zinc plated $\geq 5 \mu\text{m}$, ISO 4042:2018/Zn5/An(A2K) fracture elongation $A_5 > 8 \%$	Property class 70 EN ISO 3506-1:2009 1.4401; 1.4404; 1.4578; 1.4571; 1.4439; 1.4362 EN 10088-1:2014 fracture elongation $A_5 > 8 \%$	Property class 70 EN ISO 3506-1:2009 1.4565; 1.4529 EN 10088-1:2014 fracture elongation $A_5 > 8 \%$
7	fischer filling disc similar to DIN 6319-G	zinc plated $\geq 5 \mu\text{m}$, ISO 4042:2018/Zn5/An(A2K) or hot dip galvanised $\geq 40 \mu\text{m}$ EN ISO 10684:2004	1.4401; 1.4404; 1.4578; 1.4571; 1.4439; 1.4362 EN 10088-1:2014	1.4565; 1.4529 EN 10088-1:2014

fischer RM II	Annex A 3 Appendix 5/ 18
Product description Materials	

Specifications of intended use (part 1)

Table B1.1: Overview use and performance categories

Anchorages subject to		RM II with ...			
		fischer anchor rod RG M 	fischer internal threaded anchor RG M I 		
Hammer drilling with standard drill bit 		all sizes	all sizes		
Hammer drilling with hollow drill bit (fischer „FHD“, Heller "Duster Expert"; Bosch „Speed Clean“; Hilti "TE-CD, TE-YD", DreBo „D-Plus“, DreBo „D-Max“) 		Nominal drill bit diameter (d ₀) 12 mm to 28 mm		all sizes	
Static and quasi static load, in	uncracked concrete	all sizes	Tables: C1.1, C3.1, C4.1, C6.1	all sizes	Tables: C2.1, C3.1, C5.1, C6.2
	cracked concrete	M10, M12, M16, M20, M24			
Use category	I1 dry or wet concrete	all sizes		all sizes	
	I2 flooded hole	M12, M16, M20, M24		M8, M10, M16	
Installation direction		D3 (downward and horizontal and upwards (e.g. overhead) installation)			
Installation temperature		$T_{i,min} = -15\text{ °C}$ to $T_{i,max} = +40\text{ °C}$			
In-service temperature	Temperature range I	-40 °C to +40 °C	(max. short term temperature +40 °C and max. long term temperature +24 °C)		
	Temperature range II	-40 °C to +80 °C	(max. short term temperature +80 °C and max. long term temperature +50 °C)		
	Temperature range III	-40 °C to +120 °C	(max. short term temperature +120 °C and max. long term temperature +72 °C)		
fischer RM II		Annex B 1 Appendix 6/ 18			
Intended Use Specifications (part 1)					

Specifications of intended use (part 2)

Base materials:

- Compacted reinforced or unreinforced normal weight concrete without fibres strength classes C20/25 to C50/60 according to EN 206:2013+A1:2016

Use conditions (Environmental conditions):

- Structures subject to dry internal conditions (zinc coated steel, stainless steel or high corrosion resistant steel)
- For all other conditions according to EN1993-1-4:2015 corresponding to corrosion resistance classes to Annex A 3 table A3.1.

Design:

- Anchorages have to be designed by a responsible engineer with experience of concrete anchor design.
- Verifiable calculation notes and drawings are to be prepared taking account of the loads to be anchored. The position of the anchor is indicated on the design drawings (e.g. position of the anchor relative to reinforcement or to supports, etc.)
- Anchorages are designed in accordance with:
EN 1992-4:2018 and EOTA Technical Report TR 055, Edition February 2018.

Installation:

- Anchor installation has to be carried out by appropriately qualified personnel and under the supervision of the person responsible for technical matters of the site
- In case of aborted hole: The hole shall be filled with mortar
- Anchorage depth should be marked and adhered to on installation
- Overhead installation is allowed

fischer RM II

Intended Use
Specifications (part 2)

Annex B 2

Appendix 7/ 18

Table B3.1: Installation parameters for fischer anchor rods RG M

Anchor rods RG M		thread	M8	M10	M12	M16	M20	M24
Width across flats	SW	[mm]	13	17	19	24	30	36
Nominal drill bit diameter	d_0		10	12	14	18	25	28
Drill hole depth	h_0		$h_0 = h_{ef}$					
Effective embedment depth	h_{ef}		80	90	110	125	170	210
Minimum spacing and minimum edge distance	$s_{min} = c_{min}$		40	45	55	65	85	105
Diameter of clearance hole in the pre-positioned anchorage fixture ¹⁾	d_f		9	12	14	18	22	26
Minimum thickness of concrete member	h_{min}		$h_{ef} + 30$ (≥ 100)			$h_{ef} + 2d_0$		
Maximum installation torque	$\max T_{inst}$	[Nm]	10	20	40	60	120	150

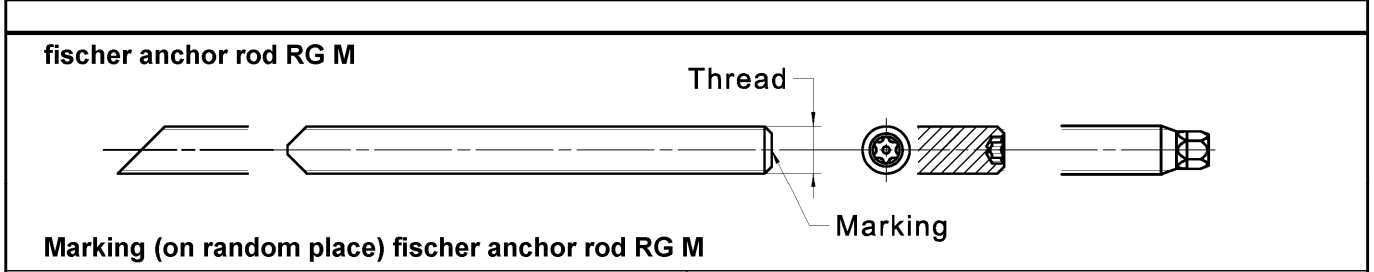

Marking (on random place) fischer anchor rod RG M

Steel zinc plated PC ¹⁾ 8.8	• or +	Steel hot-dip PC ¹⁾ 8.8	•
High corrosion resistant steel HCR PC ¹⁾ 50	•	High corrosion resistant steel HCR PC ¹⁾ 70	-
High corrosion resistant steel HCR PC ¹⁾ 80	(Stainless steel R property class 50	~
Stainless steel R property class 80	*		

Alternatively: Colour coding according to DIN 976-1:2016 ¹⁾ PC = property class

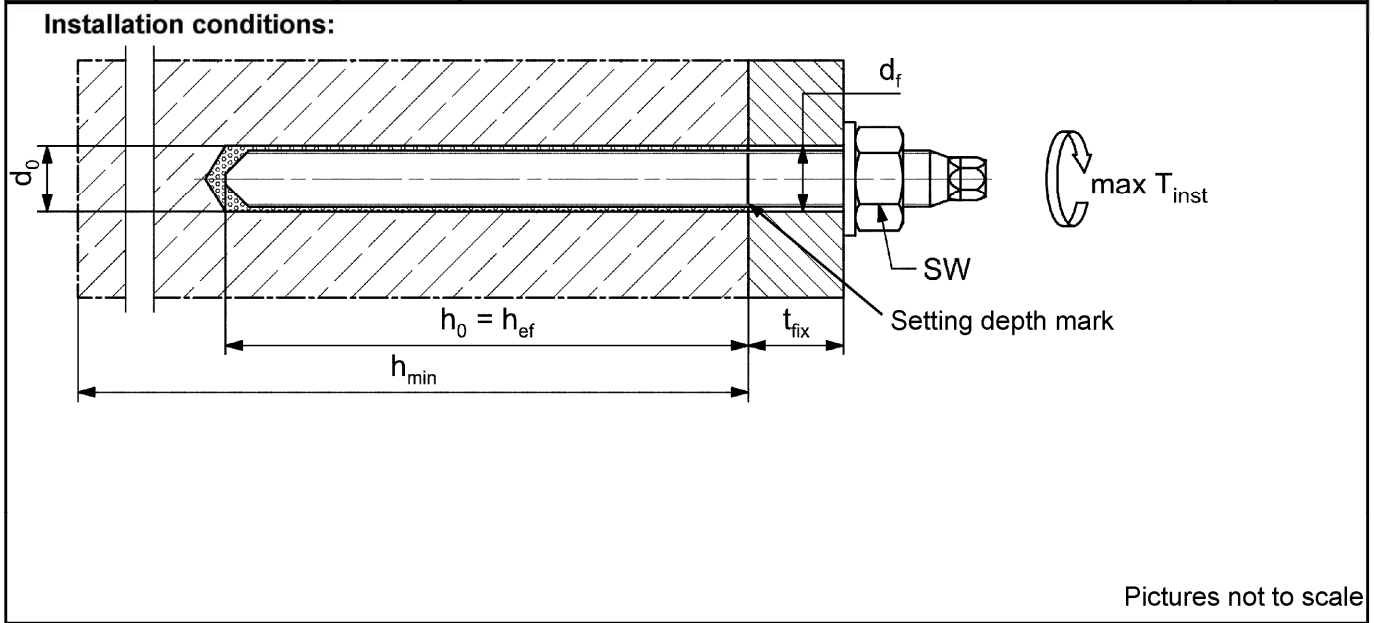

Pictures not to scale

fischer RM II	<p>Annex B 3</p> <p>Appendix 8/ 18</p>
<p>Intended Use</p> <p>Installation parameters anchor rods RG M</p>	

Table B4.1: Installation parameters for **fischer internal threaded anchors RG M I**

Internal threaded anchors RG M I		thread	M8	M10	M12	M16	M20
Diameter of anchor	$d = d_H$	[mm]	12	16	18	22	28
Nominal drill bit diameter	d_0		14	18	20	24	32
Drill hole depth	h_0		$h_0 = h_{ef} = L_H$				
Effective embedment depth ($h_{ef} = L_H$)	h_{ef}		90	90	125	160	200
Minimum spacing and minimum edge distance	s_{min} = c_{min}		55	65	75	95	125
Diameter of clearance hole in the fixture ¹⁾	d_f		9	12	14	18	22
Minimum thickness of concrete member	h_{min}		120	125	165	205	260
Maximum screw-in depth	$l_{E,max}$		18	23	26	35	45
Minimum screw-in depth	$l_{E,min}$		8	10	12	16	20
Maximum installation torque	$\max T_{inst}$	[Nm]	10	20	40	80	120

fischer internal threaded anchor RG M I

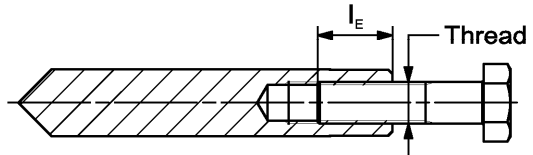
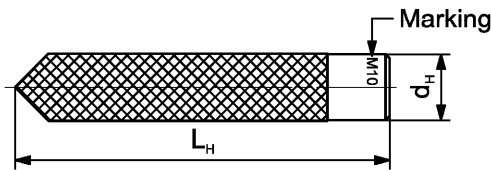

Marking: Anchor size e. g.: **M10**
 Stainless steel → additional **R**; e.g.: **M10 R**
 High corrosion resistant steel → additional **HCR**; e.g.: **M10 HCR**

Retaining bolt or threaded rods (including nut and washer) must comply with the appropriate material and strength class of Annex A 3, Table A3.1.

Installation conditions:

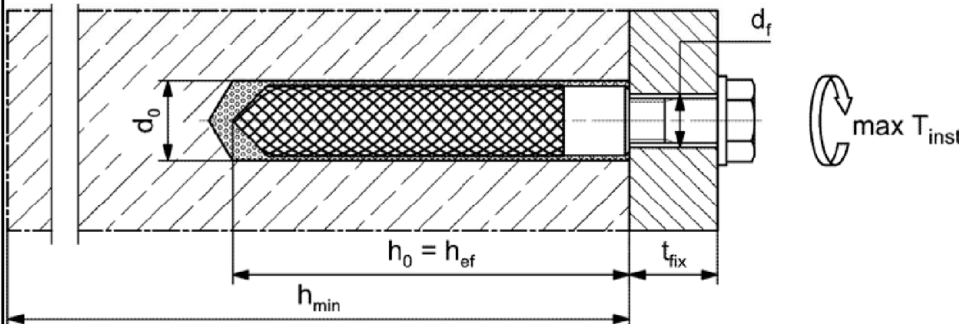

Pictures not to scale

fischer RM II

Intended Use
 Installation parameters fischer internal threaded anchors RG M I

Annex B 4

Appendix 9/ 18

Table B5.1: Dimensions of resin capsule RM II								
Capsule RM II		8	10	12	16	16 E	20/22	24
Capsule diameter	d_P	[mm]	9,0	10,5	12,5	16,5		23,0
Capsule length	L_P		85	90	97	95	123	160

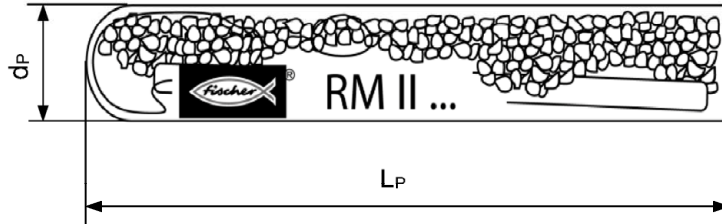

Table B5.2: Assignment of resin capsule RM II to fischer anchor rod RG M

Anchor rod RG M			M8	M10	M12	M16	M20	M24
Effective anchorage depth	h_{ef}	[mm]	80	90	110	125	170	210
Related capsule RM II		[-]	8	10	12	16	20/22	24

Table B5.3: Assignment of resin capsule RM II to the fischer internal threaded anchor RG M I

Internal threaded anchor RG M I			M8	M10	M12	M16	M20
Effective anchorage depth	h_{ef}	[mm]	90	90	125	160	200
Related capsule RM II		[-]	10	12	16	16E	24

Table B5.4: Minimum curing time

(During the curing time of the mortar the concrete temperature may not fall below the listed minimum temperature; minimal capsule temperature -15 °C)

Concrete temperature [°C]	Minimum curing time t_{cure}
-15 to -10	30 h
> -10 to -5	16 h
> -5 to 0	10 h
> 0 to 5	45 min
> 5 to 10	30 min
> 10 to 20	20 min
> 20 to 30	5 min
> 30 to 40	3 min

fischer RM II	Annex B 5 Appendix 10/ 18
Intended Use Dimensions of the capsules, Assignment of the capsule to the anchor rod and internal threaded anchor, Minimum curing time	

Installation instructions part 1

Drilling and cleaning the hole (hammer drilling with standard drill bit)

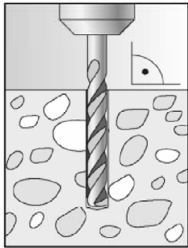
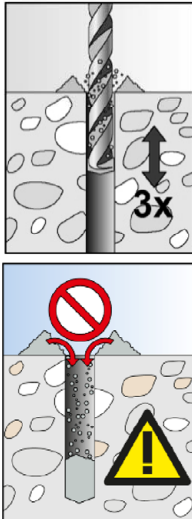
1		<p>Specified drill hole depth h_0 should be adhered to (e.g. mark on the drill bit). Drill the hole. Drill hole diameter d_0 and drill hole depth h_0 see Tables B3.1, B4.1</p>
2		<p>When reaching the drill hole depth h_0 pull out the drill bit whilst power drill is switched on. To reduce the drill dust in the drill hole repeat this step minimum three times, beginning from the drill hole bottom (discharging the bore hole)</p> <p>Trickling of the bore dust into the drill hole has to be avoided. (e.g. with exhausting the drill dust) Blowing out or brushing the drill hole is not necessary</p>

Go to step 3

Drilling and cleaning the hole (hammer drilling with hollow drill bit)

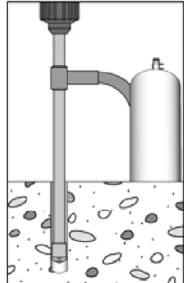
1		<p>Check a suitable hollow drill (see Table B1.1) for correct operation of the dust extraction</p>
2		<p>Use a suitable dust extraction system, e.g. fischer FVC 35 M or a comparable dust extraction system with equivalent performance data</p> <p>Drill the hole with hollow drill bit. The dust extraction system has to extract the drill dust nonstop during the drilling process and must be adjusted to maximum power. Diameter of drill hole d_0 and drill hole depth h_0 see Tables B3.1, B4.1</p>

Go to step 3

fischer RM II



Intended use
Installation instructions part 1

Annex B 6

Appendix 11/ 18

Installation instructions part 2

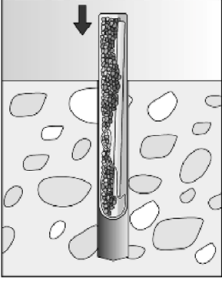
Installation of capsule RM II with fischer anchor rods RG M or fischer internal threaded anchors RG M I

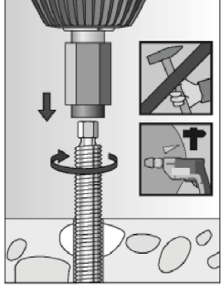
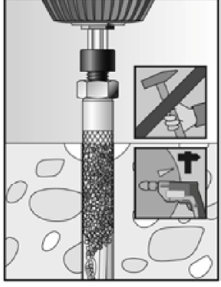
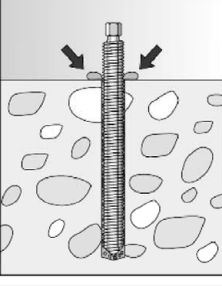
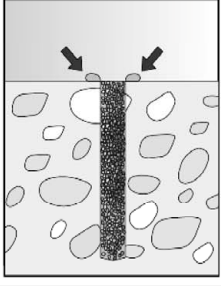
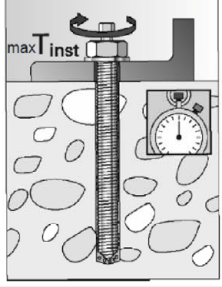
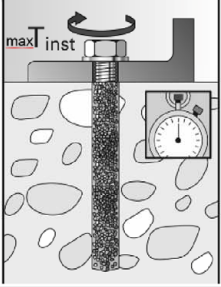
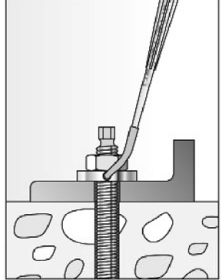
3		<p>Push the capsule RM II into the drill hole</p>		<p>Depending on the anchor being installed, use a suitable setting tool (e.g. RA-SDS)</p>
4			<p>Only use clean and oil-free metal parts. Using a suitable adapter, drive the RG M or fischer internal threaded anchor RG M I into the capsule using a hammer drill set on rotary hammer action. Stop when the metal part reaches the bottom of the hole and is set to the correct embedment depth</p>	
5			<p>When reaching the correct embedment depth, excess mortar must be emerged from the mouth of the drill hole</p>	
6			<p>Wait for the specified curing time, t_{cure} see Table B5.4</p> <p>Mounting the fixture $max T_{inst}$ see Table B3.1, B4.1</p>	
Option		<p>After the minimum curing time is reached, the gap between metal part and fixture (annular clearance) may be filled with mortar via the fischer filling disc. compressive strength $\geq 50 \text{ N/mm}^2$ (e.g. fischer injection mortars FIS HB, FIS SB, FIS V, FIS EM Plus)</p>		

fischer RM II

Intended use
Installation instructions part 2

Annex B 7

Appendix 12/ 18

Table C1.1: Characteristic values for **steel failure** under tension / shear load of **fischer anchor rods RG M**

Anchor rod RG M		M8	M10	M12	M16	M20	M24			
Bearing capacity under tension load, steel failure³⁾										
Characteristic resistance $N_{Rk,s}$	Steel zinc plated	Property class	4.8	[kN]	15(13)	23(21)	33	63	98	141
			5.8		19(17)	29(27)	43	79	123	177
			8.8		29(27)	47(43)	68	126	196	282
	Stainless steel R and high corrosion resistant steel HCR		50		19	29	43	79	123	177
			70		26	41	59	110	172	247
			80		30	47	68	126	196	282
Partial factors¹⁾										
Partial factor $\gamma_{Ms,N}$	Steel zinc plated	Property class	4.8	[-]	1,50					
			5.8		1,50					
			8.8		1,50					
	Stainless steel R and high corrosion resistant steel HCR		50		2,86					
			70		1,50 ²⁾ / 1,87					
			80		1,60					
Bearing capacity under shear load, steel failure³⁾										
without lever arm										
Characteristic resistance $V_{Rk,s}^0$	Steel zinc plated	Property class	4.8	[kN]	9(8)	14(13)	20	38	59	85
			5.8		11(10)	17(16)	25	47	74	106
			8.8		15(13)	23(21)	34	63	98	141
	Stainless steel R and high corrosion resistant steel HCR		50		9	15	21	39	61	89
			70		13	20	30	55	86	124
			80		15	23	34	63	98	141
Ductility factor	k_7	[-]	1,0							
with lever arm										
Charact. resistance $M_{Rk,s}^0$	Steel zinc plated	Property class	4.8	[Nm]	15(13)	30(27)	52	133	259	448
			5.8		19(16)	37(33)	65	166	324	560
			8.8		30(26)	60(53)	105	266	519	896
	Stainless steel R and high corrosion resistant steel HCR		50		19	37	65	166	324	560
			70		26	52	92	232	454	784
			80		30	60	105	266	519	896
Partial factors¹⁾										
Partial factor $\gamma_{Ms,V}$	Steel zinc plated	Property class	4.8	[-]	1,25					
			5.8		1,25					
			8.8		1,25					
	Stainless steel R and high corrosion resistant steel HCR		50		2,38					
			70		1,25 ²⁾ / 1,56					
			80		1,33					

¹⁾ In absence of other national regulations

²⁾ Only for fischer RG M made of high corrosion-resistant steel HCR

³⁾ Values in brackets are valid for undersized fischer anchor rods RG M with smaller stress area A_s for hot dip galvanised standard threaded rods according to EN ISO 10684:2004+AC:2009

fischer RM II

Performances

Characteristic values for steel failure under tension / shear load of fischer anchor rods RG M

Annex C 1

Appendix 13/ 18

Table C2.1: Characteristic values for **steel failure** under tension / shear load of **fischer internal threaded anchors RG M I**

Internal threaded anchor RG M I				M8	M10	M12	M16	M20
Bearing capacity under tension load, steel failure								
Characteristic bearing capacity with screw	Property class	5.8	[kN]	19	29	43	79	123
		8.8		29	47	68	108	179
		R		26	41	59	110	172
		HCR		26	41	59	110	172
Partial factors¹⁾								
Partial factor	Property class	5.8	[-]	1,50				
		8.8		1,50				
		R		1,87				
		HCR		1,87				
Bearing capacity under shear load, steel failure								
without lever arm								
Characteristic bearing capacity with screw	Property class	5.8	[kN]	9,2	14,5	21,1	39,2	62,0
		8.8		14,6	23,2	33,7	54,0	90,0
		R		12,8	20,3	29,5	54,8	86,0
		HCR		12,8	20,3	29,5	54,8	86,0
Ductility factor		K ₇	[-]	1,0				
with lever arm								
Characteristic bending moment with screw	Property class	5.8	[Nm]	20	39	68	173	337
		8.8		30	60	105	266	519
		R		26	52	92	232	454
		HCR		26	52	92	232	454
Partial factors¹⁾								
Partial factor	Property class	5.8	[-]	1,25				
		8.8		1,25				
		R		1,56				
		HCR		1,56				

¹⁾ In absence of other national regulations

fischer RM II

Performances

Characteristic values for steel failure under tension / shear load of fischer internal threaded anchor RG M I

Annex C 2

Appendix 14/ 18

Table C3.1: Characteristic values for concrete failure under tension / shear load									
Size			All sizes						
Tension load									
Installation factor		γ_{inst}	[-]	See annex C 4 to C 5					
Factors for the compressive strength of concrete > C20/25									
Increasing factor for τ_{RK}	C25/30		Ψ_c	[-]	1,02				
	C30/37				1,04				
	C35/45				1,07				
	C40/50				1,08				
	C45/55				1,09				
	C50/60				1,10				
Splitting failure									
Edge distance	$h / h_{ef} \geq 2,0$		$C_{cr,sp}$	[mm]	1,0 h_{ef}				
	$2,0 > h / h_{ef} > 1,3$				4,6 h_{ef} - 1,8 h				
	$h / h_{ef} \leq 1,3$				2,26 h_{ef}				
Spacing		$S_{cr,sp}$			2 $C_{cr,sp}$				
Concrete cone failure									
Uncracked concrete		$k_{ucr,N}$	[-]	11,0					
Cracked concrete		$k_{cr,N}$		7,7					
Edge distance		$C_{cr,N}$	[mm]	1,5 h_{ef}					
Spacing		$S_{cr,N}$		2 $C_{cr,N}$					
Factors for sustained tension load									
Factor		Ψ_{sus}^0	[-]	- ¹⁾					
Shear load									
Installation factor		γ_{inst}	[-]	1,0					
Concrete pry-out failure									
Factor for pry-out failure		k_8	[-]	2,0					
Concrete edge failure									
Effective length of fastener in shear loading		l_f	[mm]	for $d_{nom} \leq 24$ mm: min (h_{ef} ; 12 d_{nom})					
Calculation diameters									
Size			M8	M10	M12	M16	M20	M24	
fischer anchor rods		d	[mm]	8	10	12	16	20	24
fischer internal threaded anchors RG M I		d_{nom}		12	16	18	22	28	- ²⁾
¹⁾ No performance assessed ²⁾ Anchor type not part of the assessment									
fischer RM II							Annex C 3 Appendix 15/ 18		
Performances Characteristic values for concrete failure under tensile / shear load									

Table C4.1: Characteristic values for combined pull-out and concrete failure for fischer anchor rods RG M in hammer drilled holes; uncracked or cracked concrete									
Anchor rod RG M			M8	M10	M12	M16	M20	M24	
Combined pullout and concrete cone failure									
Calculation diameter d [mm]			8	10	12	16	20	24	
Uncracked concrete									
Characteristic bond resistance in uncracked concrete C20/25									
<u>Hammer-drilling with standard drill bit or hollow drill bit (dry and wet concrete)</u>									
Tem- perature range	I: 40 °C / 24 °C		$\tau_{Rk,ucr}$ [N/mm ²]	12,5	12,5	12,5	12,5	12,5	12,5
	II: 80 °C / 50 °C			12,0	12,0	12,0	12,0	12,0	12,0
	III: 120 °C / 72 °C			10,5	10,5	10,5	10,5	10,5	10,5
<u>Hammer-drilling with standard drill bit or hollow drill bit (flooded hole)</u>									
Tem- perature range	I: 40 °C / 24 °C		$\tau_{Rk,ucr}$ [N/mm ²]	- ¹⁾	- ¹⁾	12,5	12,5	12,5	12,5
	II: 80 °C / 50 °C			- ¹⁾	- ¹⁾	12,0	12,0	12,0	12,0
	III: 120 °C / 72 °C			- ¹⁾	- ¹⁾	10,5	10,5	10,5	10,5
Installation factors									
Dry and wet concrete			γ_{inst} [-]	1,2					
Flooded hole				- ¹⁾	- ¹⁾	1,4			
Cracked concrete									
Characteristic bond resistance in cracked concrete C20/25									
<u>Hammer-drilling with standard drill bit or hollow drill bit (dry and wet concrete)</u>									
Tem- perature range	I: 40 °C / 24 °C		$\tau_{Rk,cr}$ [N/mm ²]	- ¹⁾	4,5	4,5	4,5	4,5	4,5
	II: 80 °C / 50 °C			- ¹⁾	4,0	4,0	4,0	4,0	4,0
	III: 120 °C / 72 °C			- ¹⁾	3,5	3,5	3,5	3,5	3,5
<u>Hammer-drilling with standard drill bit or hollow drill bit (flooded hole)</u>									
Tem- perature range	I: 40 °C / 24 °C		$\tau_{Rk,cr}$ [N/mm ²]	- ¹⁾	- ¹⁾	4,5	4,5	4,5	4,5
	II: 80 °C / 50 °C			- ¹⁾	- ¹⁾	4,0	4,0	4,0	4,0
	III: 120 °C / 72 °C			- ¹⁾	- ¹⁾	3,5	3,5	3,5	3,5
Installation factors									
Dry and wet concrete			γ_{inst} [-]	- ¹⁾	1,2				
Flooded hole				- ¹⁾	- ¹⁾	1,4			
¹⁾ No performance assessed									
fischer RM II							Annex C 4 Appendix 16/ 18		
Performances Characteristic values for combined pull-out and concrete failure for fischer anchor rod RG M									

Table C5.1: Characteristic values for **combined pull-out** and concrete failure for **fischer internal threaded anchors RG M I** in hammer drilled holes; **uncracked or cracked concrete**

Internal threaded anchors RG M I			M8	M10	M12	M16	M20
Combined pullout and concrete cone failure							
Calculation diameter	d	[mm]	12	16	18	22	28
Uncracked concrete							
Characteristic bond resistance in uncracked concrete C20/25							
<u>Hammer-drilling with standard drill bit or hollow drill bit (dry and wet concrete)</u>							
Tem- perature range	I: 40 °C / 24 °C	$\tau_{Rk,ucr}$ [N/mm ²]	11	11	11	11	11
	II: 80 °C / 50 °C		10,5	10,5	10,5	10,5	10,5
	III: 120 °C / 72 °C		9,5	9,5	9,5	9,5	9,5
<u>Hammer-drilling with standard drill bit or hollow drill bit (flooded hole)</u>							
Tem- perature range	I: 40 °C / 24 °C	$\tau_{Rk,ucr}$ [N/mm ²]	11	11	- ¹⁾	11	- ¹⁾
	II: 80 °C / 50 °C		10,5	10,5	- ¹⁾	10,5	- ¹⁾
	III: 120 °C / 72 °C		9,5	9,5	- ¹⁾	9,5	- ¹⁾
Installation factors							
Dry and wet concrete	γ_{inst}	[-]	1,2				
Flooded hole			1,4	- ¹⁾	1,4	- ¹⁾	
Cracked concrete							
Characteristic bond resistance in cracked concrete C20/25							
<u>Hammer-drilling with standard drill bit or hollow drill bit (dry and wet concrete)</u>							
Tem- perature range	I: 40 °C / 24 °C	$\tau_{Rk,cr}$ [N/mm ²]	4,5	4,5	4,5	4,5	4,5
	II: 80 °C / 50 °C		4,0	4,0	4,0	4,0	4,0
	III: 120 °C / 72 °C		3,5	3,5	3,5	3,5	3,5
<u>Hammer-drilling with standard drill bit or hollow drill bit (flooded hole)</u>							
Tem- perature range	I: 40 °C / 24 °C	$\tau_{Rk,cr}$ [N/mm ²]	4,5	4,5	- ¹⁾	4,5	- ¹⁾
	II: 80 °C / 50 °C		4,0	4,0	- ¹⁾	4,0	- ¹⁾
	III: 120 °C / 72 °C		3,5	3,5	- ¹⁾	3,5	- ¹⁾
Installation factors							
Dry and wet concrete	γ_{inst}	[-]	1,2				
Flooded hole			1,4	- ¹⁾	1,4	- ¹⁾	

¹⁾ No performance assessed

fischer RM II

Performances

Characteristic values for combined pull-out and concrete failure for fischer internal threaded anchors RG M I

Annex C 5

Appendix 17/ 18

Table C6.1: Displacements for fischer anchor rods RG M

Anchor rod RG M	M8	M10	M12	M16	M20	M24	
Displacement-Factors for tension load¹⁾							
Uncracked or cracked concrete; Temperature range I, II, III							
δ_{N0} -Factor	[mm/(N/mm ²)]	0,07	0,08	0,09	0,10	0,11	0,12
$\delta_{N\infty}$ -Factor		0,13	0,14	0,15	0,17	0,17	0,18
Displacement-Factors for shear load²⁾							
Uncracked or cracked concrete; Temperature range I, II, III							
δ_{V0} -Factor	[mm/kN]	0,18	0,15	0,12	0,09	0,07	0,06
$\delta_{V\infty}$ -Factor		0,27	0,22	0,18	0,14	0,11	0,09
1) Calculation of effective displacement: $\delta_{N0} = \delta_{N0}\text{-Factor} \cdot \tau_{Ed}$ $\delta_{N\infty} = \delta_{N\infty}\text{-Factor} \cdot \tau_{Ed}$ (τ_{Ed} : Design value of the applied tensile stress)				2) Calculation of effective displacement: $\delta_{V0} = \delta_{V0}\text{-Factor} \cdot V_{Ed}$ $\delta_{V\infty} = \delta_{V\infty}\text{-Factor} \cdot V_{Ed}$ (V_{Ed} : Design value of the applied shear force)			

Table C6.2: Displacements for fischer internal threaded anchors RG M I

Internal threaded anchor RG M I	M8	M10	M12	M16	M20	
Displacement-Factors for tension load¹⁾						
Uncracked or cracked concrete; Temperature range I, II, III						
δ_{N0} -Factor	[mm/(N/mm ²)]	0,09	0,10	0,10	0,11	0,19
$\delta_{N\infty}$ -Factor		0,13	0,15	0,15	0,17	0,19
Displacement-Factors for shear load²⁾						
Uncracked or cracked concrete; Temperature range I, II, III						
δ_{V0} -Factor	[mm/kN]	0,12	0,09	0,08	0,07	0,05
$\delta_{V\infty}$ -Factor		0,18	0,14	0,12	0,10	0,08
1) Calculation of effective displacement: $\delta_{N0} = \delta_{N0}\text{-Factor} \cdot \tau_{Ed}$ $\delta_{N\infty} = \delta_{N\infty}\text{-Factor} \cdot \tau_{Ed}$ (τ_{Ed} : Design value of the applied tensile stress)			2) Calculation of effective displacement: $\delta_{V0} = \delta_{V0}\text{-Factor} \cdot V_{Ed}$ $\delta_{V\infty} = \delta_{V\infty}\text{-Factor} \cdot V_{Ed}$ (V_{Ed} : Design value of the applied shear force)			