

## PRESTANDEDEKLARATION

### DoP 0334

för fischer Anchor bolt FAZ II Plus, FAZ II Plus R, FAZ II Plus HCR (Metallankare för användning i betong)

SV

1. Produkttypens unika identifikationskod: **DoP 0334**
2. Avsedd användning/avsedda användningar: **Infästning i efterhand i sprucken och osprucken betong, se bilaga, särskilt bilagor B1 - B4.**
3. Tillverkare: **fischerwerke GmbH & Co. KG, Klaus-Fischer-Str. 1, 72178 Waldachtal, Tyskland**
4. Tillverkarens representant: **–**
5. System för bedömning och fortlöpande kontroll av prestanda: **1**
6. Europeiskt bedömningsdokument: **EAD 330232-01-0601, Edition 05/2021**  
Europeisk teknisk bedömning: **ETA-19/0520; 2023-05-24**  
Tekniskt bedömningsorgan: **DIBt- Deutsches Institut für Bautechnik**  
Anmält/anmälda organ: **2873 TU Darmstadt**

### 7. Angiven prestanda:

#### **Mekanisk hållfasthet och stabilitet (BWR 1)**

##### **Karakteristisk bärförmåga för spänning (för statisk och kvasi-statisk belastning) Metod A:**

Stålets motståndskraft: Bilagor C1  
Motstånd mot att skruven dras ut: Bilagor C1  
Motstånd i betongkonen: Bilagor C1  
Kraftighet: Bilagor C1  
Minsta kant- och axelavstånd: Bilagor C5, C6  
Kantavstånd för att slippa sprickor under last: Bilagor C1

##### **Karakteristisk bärförmåga för skjuvning (för statisk och kvasi-statisk belastning), Metod A:**

Motstånd i stålet (tvärlast): Bilagor C2  
Motstånd mot fläkning: Bilagor C2

##### **Karakteristisk motstånd för förenklad design:**

Metod B: NPD  
Metod C: NPD

##### **Förskjutningar:**

Förskjutningar under statisk och kvasistatisk belastning: Bilagor C9

##### **Karakteristiskt motstånd och Förskjutningar för seismiska prestandakategorier C1 och C2:**

Motstånd mot draglast, förskjutningar, kategori C1: Bilaga C7  
Motstånd mot draglast, förskjutningar, kategori C2: Bilagor C8, C9  
Motstånd mot tvärlast, förskjutningar, kategori C1: Bilaga C7  
Motstånd mot tvärlast, förskjutningar, kategori C2: Bilagor C8, C9  
Faktor cirkulärt hål: Bilagor C7, C8

#### **Säkerhet vid brand (BWR 2)**

Reaktion vid brand: Klass (A1)

##### **Motståndskraft mot eld:**

Brandmotstånd i stålet (tvärlast): Bilaga C3  
Brandmotstånd mot utdrag (draglast): Bilaga C3  
Brandmotstånd i stålet (tvärlast): Bilagor C3, C4

#### **Hållbarhet:**

Hållbarhet: Bilagor A4, B1

8. Lämplig teknisk dokumentation och/eller särskild teknisk dokumentation: **–**



Prestandan för ovanstående produkt överensstämmer med den angivna prestandan. Denna prestandadeklaration har utfärdats i enlighet med förordning (EU) nr 305/2011 på eget ansvar av den tillverkare som anges ovan.

Undertecknad på tillverkarens vägnar av:



Dr.-Ing. Oliver Geibig, Verkställande direktör affärsenheter och teknik  
Tumlingen, 2023-05-31



Jürgen Grün, Verkställande direktör kemi och kvalitet

Denna DoP har förberetts på olika språk. I händelse av tvist om tolkningen ska den engelska versionen alltid råda.

Bilagan innehåller frivilliga och kompletterande information på engelska som överskrider (det specifika språkets) lagkrav.

## Specific Part

### 1 Technical description of the product

The Fischer Bolt Anchor FAZ II Plus, FAZ II Plus R, FAZ II Plus HCR is an anchor made of galvanized steel (FAZ II Plus), stainless steel (FAZ II Plus R) or high corrosion resistant steel (FAZ II Plus HCR) which is placed into a drilled hole and anchored by torque-controlled expansion.

The product description is given in Annex A.

### 2 Specification of the intended use in accordance with the applicable European Assessment Document

The performances given in Section 3 are only valid if the anchor is used in compliance with the specifications and conditions given in Annex B.

The verifications and assessment methods on which this European Technical Assessment is based lead to the assumption of a working life of the anchor of at least 50 years. The indications given on the working life cannot be interpreted as a guarantee given by the producer, but are to be regarded only as a means for choosing the right products in relation to the expected economically reasonable working life of the works.

### 3 Performance of the product and references to the methods used for its assessment

#### 3.1 Mechanical resistance and stability (BWR 1)

Essential characteristic	Performance
Characteristic resistance to tension load (static and quasi-static loading), Method A	See Annex C1, C5 and C6
Characteristic resistance to shear load (static and quasi-static loading)	See Annex C2
Displacements	See Annex C9
Characteristic resistance and displacements for seismic performance categories C1 and C2	See Annex C7 to C9

#### 3.2 Safety in case of fire (BWR 2)

Essential characteristic	Performance
Reaction to fire	Class A1
Resistance to fire	See Annex C3 and C4

#### 3.3 Aspects of Durability

Essential characteristic	Performance
Durability	See Annex B1

**4 Assessment and verification of constancy of performance (AVCP) system applied, with reference to its legal base**

In accordance with the European Assessment Document EAD 330232-01-0601 the applicable European legal act is: [96/582/EC].

The system to be applied is: 1

Cone bolt manufactured by cold - forming:

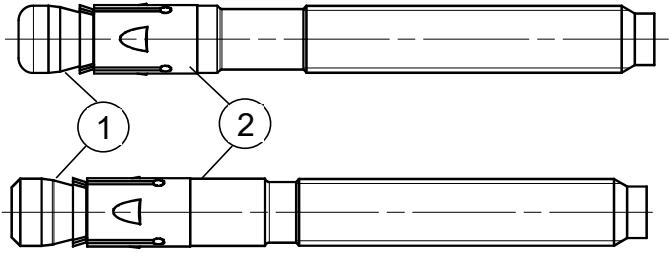

Cone bolt manufactured by turning:

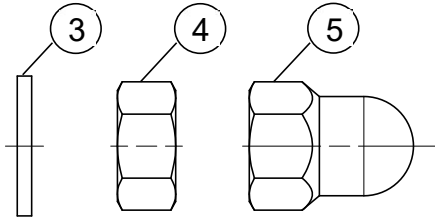

- ① Expansion sleeve
- ② Cone bolt (cold – formed or turned)
- ③ Washer
- ④ Hexagon nut
- ⑤ fischer FAZ II Plus dome nut

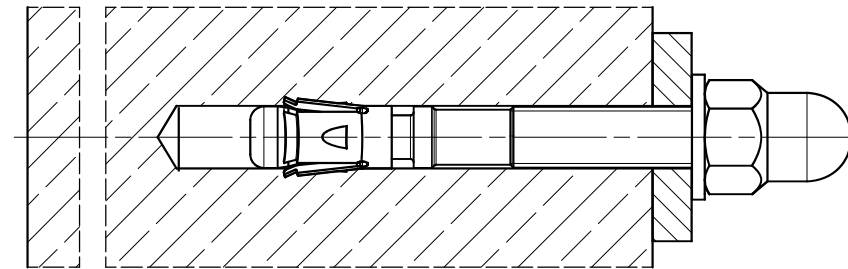
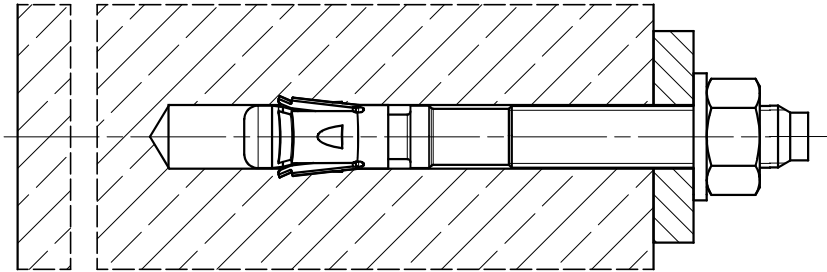

*(Figure not to scale)*

fischer Bolt Anchor FAZ II Plus, FAZ II Plus R,  
FAZ II Plus HCR

**Product description**  
Installed condition

**Annex A1**

Annex 3 / 19

## Product marking and letter-code:

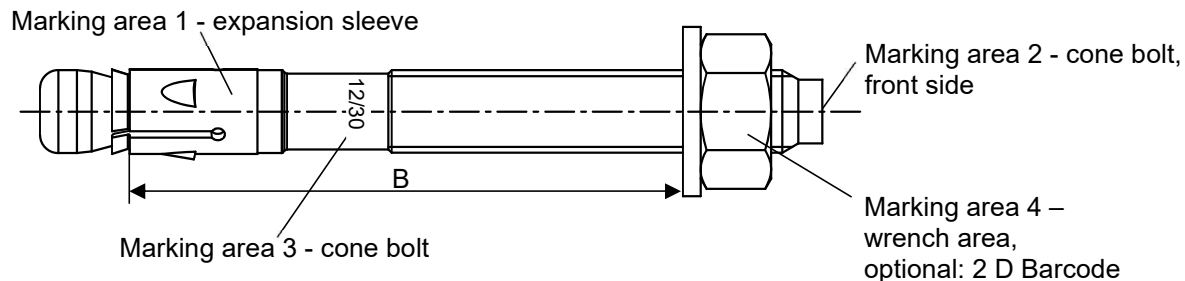

Product marking, example:

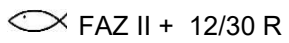

Brand | type of fastener  
placed at marking area 1 or 3

Thread size / max. thickness of the fixture ( $t_{fix}$ )  
identification R or HCR placed at marking area 1 or 3

FAZ II Plus: carbon steel, galvanised  
FAZ II Plus R: stainless steel  
FAZ II Plus HCR: high corrosion resistant steel

**Table A2.1:** Letter - code at marking area 2:

Marking	(a)	(b)	(c)	(d)	(A)	(B)	(C)	(D)	(E)	(F)	(G)	(H)	(I)	(K)	
Max. $t_{fix}$ [mm]	5	10	15	20	5	10	15	20	25	30	35	40	45	50	
$B \geq$ [mm]	M6	-			45	50	55	60	65	70	75	80	85	90	
	M8	40	45	-		50	55	60	65	70	75	80	85	90	
	M10	45	50	55	60	65	70	75	80	85	90	95	100	105	
	M12	55	60	65	70	75	80	85	90	95	100	105	110	115	
	M16	70	75	80	85	90	95	100	105	110	115	120	125	130	
	M20	-				105	110	115	120	125	130	135	140	145	150
	M24	-				130	135	140	145	150	155	160	165	170	175

Marking	(L)	(M)	(N)	(O)	(P)	(R)	(S)	(T)	(U)	(V)	(W)	(X)	(Y)	(Z)
Max. $t_{fix}$ [mm]	60	70	80	90	100	120	140	160	180	200	250	300	350	400
$B \geq$ [mm]	M6	100	110	120	130	140	160	180	200	220	240	290	340	390
	M8	105	115	125	135	145	165	185	205	225	245	295	345	395
	M10	120	130	140	150	160	180	200	220	240	260	310	360	410
	M12	130	140	150	160	170	190	210	230	250	270	320	370	420
	M16	145	155	165	175	185	205	225	245	265	285	335	385	435
	M20	160	170	180	190	200	220	240	260	280	300	350	400	450
	M24	185	195	205	215	225	245	265	285	305	325	375	425	475

### Calculation existing $h_{ef}$ for installed fasteners:

$$\text{existing } h_{ef} = B_{(\text{according to table A2.1})} - \text{existing } t_{fix}$$

Thickness of the fixture  $t_{fix}$  including thickness of filling conical washer  $t$  and e.g. thickness of grout layer  $t_{grout}$  or other non-structural layers

(Figure not to scale)

fischer Bolt Anchor FAZ II Plus, FAZ II Plus R,  
FAZ II Plus HCR

**Product description**  
Product marking and letter code

**Annex A2**

Annex 4 / 19

## Product dimensions

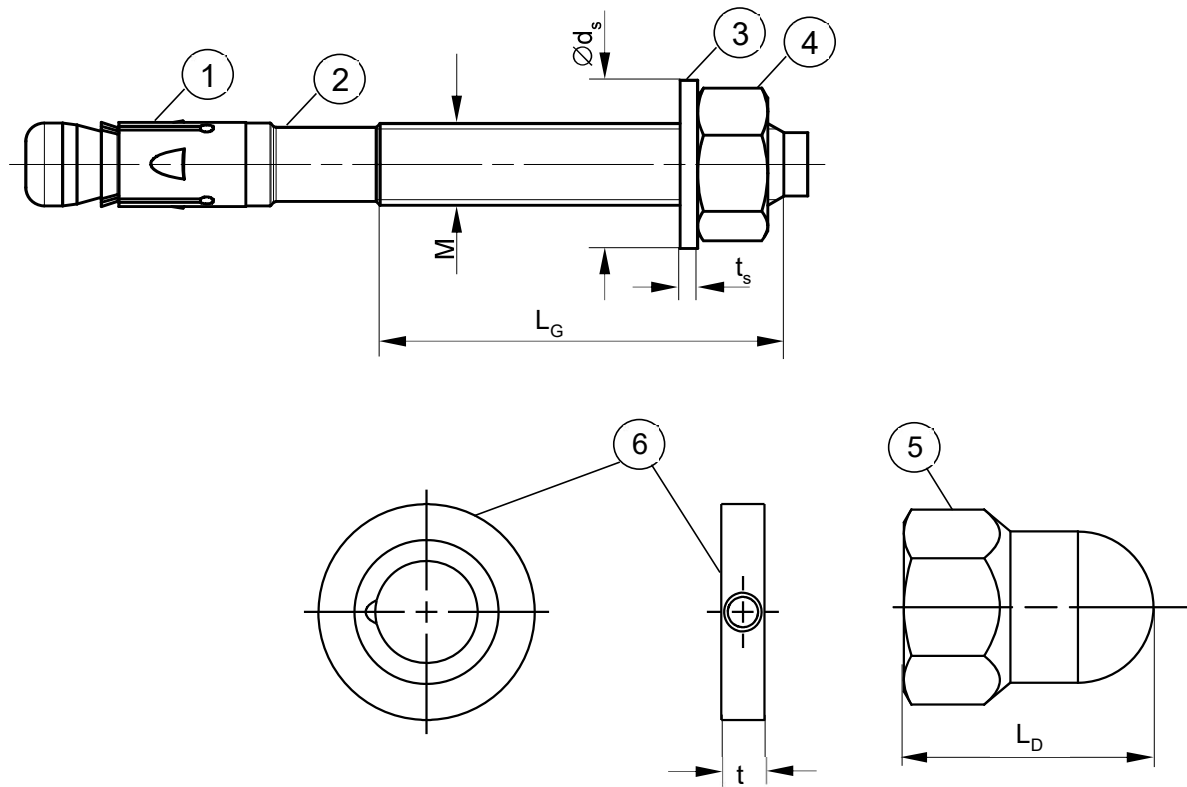

**Table A3.1:** Dimensions [mm]

Part	Designation		FAZ II Plus, FAZ II Plus R, FAZ II Plus HCR						
			M6	M8	M10	M12	M16	M20	M24
1	Expansion sleeve	Sheet thickness	0,8	1,3	1,4	1,6	2,4		3,0
2	Cone bolt	Thread size M	6	8	10	12	16	20	24
		$L_G$	10	19	26	31	40	50	57
3	Washer	$t_s$	1,4		1,8	2,3	2,7		3,7
		$\varnothing d_s$	11	15	19	23	29	36	43
4 & 5	Hexagon nut / fischer FAZ II Plus dome nut	Wrench size <sup>1)</sup>	10	13	17	19	24	30	36
5		$L_D$	- <sup>2)</sup>		22	27	33	- <sup>2)</sup>	
6	fischer filling conical washer FFD	t	6				7	8	10

<sup>1)</sup> Alternatively according to ISO 4032:2013 allowed

<sup>2)</sup> Not part of the assessment

(Figure not to scale)

fischer Bolt Anchor FAZ II Plus, FAZ II Plus R, FAZ II Plus HCR

**Product description**  
Dimensions

**Annex A3**

Annex 5 / 19

**Table A4.1: Materials FAZ II Plus**

Part	Designation	Material		
		FAZ II Plus	FAZ II Plus R	FAZ II Plus HCR
	Steel grade	Steel	Stainless steel R	High corrosion resistant steel HCR
		Zinc plated $\geq 5 \mu\text{m}$ , ISO 4042:2018	according to EN 10088:2014 Corrosion resistance class CRC III according to EN 1993-1-4:2006+A1:2015	according to EN 10088:2014 Corrosion resistance class CRC V according to EN 1993-1-4: 2006+A1:2015
1	Expansion sleeve	Cold strip, EN 10139:2016 or stainless steel EN 10088:2014	Stainless steel EN 10088:2014	
2	Cone bolt	Cold form steel or free cutting steel	Stainless steel EN 10088:2014	High corrosion resistant steel EN 10088:2014
3	Washer	Cold strip, EN 10139:2016		
4 / 5	Hexagon nut / fischer FAZ II Plus dome nut	Steel, property class min. 8, EN ISO 898-2:2012	Stainless steel EN 10088:2014; ISO 3506-2:2020; property class – min. 70	High corrosion resistant steel EN 10088:2014; ISO 3506-2:2020; property class – min. 70
6	fischer filling conical washer FFD	Cold form steel or free cutting steel	Stainless steel EN 10088:2014	High corrosion resistant steel EN 10088:2014

fischer Bolt Anchor FAZ II Plus, FAZ II Plus R,  
FAZ II Plus HCR

**Product description**  
Materials



**Annex A4**

Annex 6 / 19



## Specifications of intended use

### Fastenings subject to:

Size	FAZ II Plus, FAZ II Plus R, FAZ II Plus HCR						
	M6	M8	M10	M12	M16	M20	M24
Hammer drilling with standard drill bit 				✓			
Hammer drilling with hollow drill bit with automatic cleaning 	- <sup>1)</sup>				✓		
Diamond drilling 	- <sup>1)</sup>	✓	(for non seismic applications only)				
Static and quasi-static loads				✓			
Cracked and uncracked concrete				✓			
Fire exposure							
Seismic performance category	C1	- <sup>1)</sup>			✓		
	C2		- <sup>1)</sup>			✓	

<sup>1)</sup> No performance assessed

#### Base materials:

- Compacted reinforced and unreinforced normal weight concrete without fibres (cracked or uncracked) according to EN 206-1:2013+A2:2021
- Strength classes C20/25 to C50/60 according to EN 206:2013+A2:2021

#### Use conditions (Environmental conditions):

- Structures subject to dry internal conditions (FAZ II Plus, FAZ II Plus R, FAZ II Plus HCR)
- For all other conditions according to EN 1993-1-4:2006 + A1:2015 corresponding to corrosion resistance class
  - CRC III: for FAZ II Plus R
  - CRC V: for FAZ II Plus HCR

#### Design:

- Fastenings are to be designed under the responsibility of an engineer experienced in fastenings and concrete work
- Verifiable calculation notes and drawings are to be prepared taking account of the loads to be anchored. The position of the fastener is indicated on the design drawings (e.g. position of the fastener relative to reinforcement or to supports, etc.)
- Fastenings in stand-off installation or with a grout layer under seismic action are not covered
- In case of seismic applications the fastener shall be positioned outside of critical regions (e.g. plastic hinges) of the concrete structure
- Design of fastenings according to EN 1992-4:2018 and EOTA Technical Report TR 055:2018

fischer Bolt Anchor FAZ II Plus, FAZ II Plus R, FAZ II Plus HCR

**Intended Use**  
Specifications

**Annex B1**

Annex 7 / 19

**Table B2.1: Installation parameters**

Size	FAZ II Plus, FAZ II Plus R, FAZ II Plus HCR						
	M6	M8	M10	M12	M16	M20	M24
Nominal drill hole diameter $d_0 =$	6	8	10	12	16	20	24
Maximum bit diameter with hammer or hollow drilling $d_{cut,max}$ [mm]	6,40	8,45	10,45	12,5	16,5	20,55	24,55
Maximum bit diameter with diamond drilling	- <sup>1)</sup>	8,15		12,25	16,45	20,50	24,40
Effective embedment depth $h_{ef} \geq$	40-80	35-90	40-100	50-125	65-160	100-180	125
Length from $h_{ef}$ to end of cone bolt $L$	6,5	9,5	11,5	13,5	17,5	20,0	23,5
Overall fastener embedment depth in the concrete $h_{nom} \geq$ [mm]	$h_{ef} + L$						
Depth of drill hole to deepest point $h_1^{2)} \geq$	$h_{nom} + 3$		$h_{nom} + 5$		$h_{nom} + 10$		
Diameter of clearance hole in the fixture $d_f \leq$ [mm]	7	9	12	14	18	22	26
Required setting torque $T_{inst} =$ [Nm]	8	20	45	60	110	200	270
Excess length after hammering-in the cone bolt (for fischer dome nut applications according to Annex B4) $O =$ [mm]	- <sup>1)</sup>		12	16	20	- <sup>1)</sup>	

<sup>1)</sup> Not part of the assessment

<sup>2)</sup> For the application without drill hole cleaning:  $h_{1,nc} = h_1 + 15 \text{ mm}$

Setting gauge FAZ II Plus SL-H for fastener with fischer FAZ II Plus dome nut:

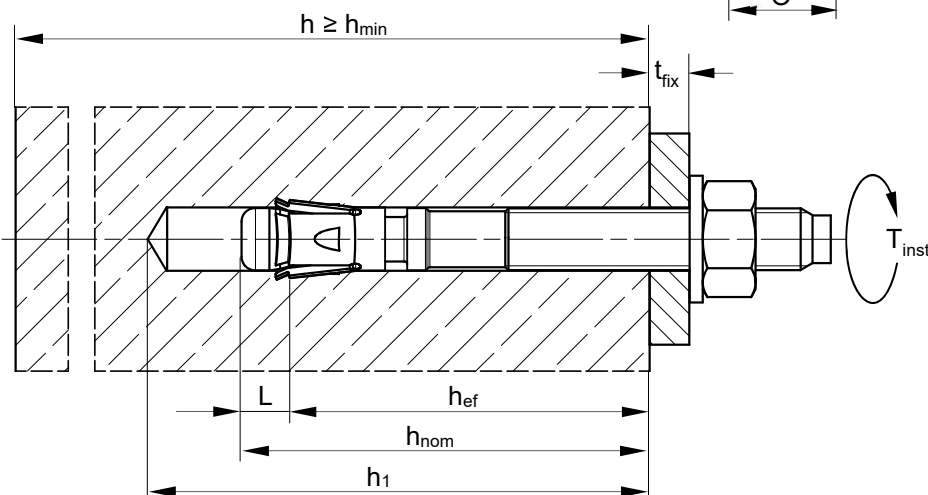
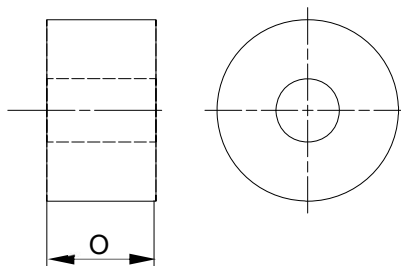

- $h_{ef}$  = Effective embedment depth
- $h_{nom}$  = Overall fastener embedment depth in the concrete
- $h_1$  = Depth of drill hole to deepest point
- $h_{1,nc}$  = Depth of drill hole to deepest point without cleaning
- $L$  = Length from  $h_{ef}$  to end of cone bolt

- $h$  = Thickness of the concrete member
- $h_{min}$  = Minimum thickness of concrete member
- $t_{fix}$  = Thickness of the fixture
- $O$  = Length of setting gauge
- $T_{inst}$  = Required setting torque

fischer Bolt Anchor FAZ II Plus, FAZ II Plus R, FAZ II Plus HCR

**Intended Use**  
Installation parameters

**Annex B2**







Annex 8 / 19

## Installation instructions:

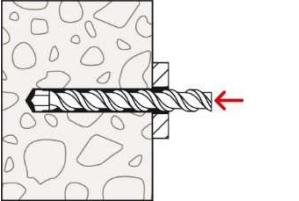
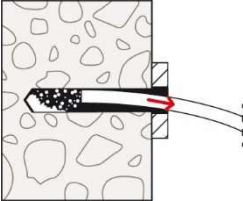
- Fastener installation carried out by appropriately qualified personnel according to the design drawings and under the supervision of the person responsible for technical matters on the site
- Use of the fastener only as supplied by the manufacturer without exchanging the components of the fastener  
Exception: fischer FAZ II Plus dome nut
- Hammer, hollow or diamond drilling according to Annex B1 + B2
- Drill hole created perpendicular +/- 5° to concrete surface, positioning without damaging the reinforcement
- In case of aborted hole: new drilling at a minimum distance twice the depth of the aborted drill hole or smaller distance if the aborted drill hole is filled with high strength mortar and if under shear or oblique tension load it is not in the direction of load application

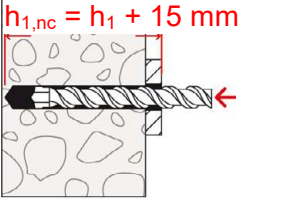
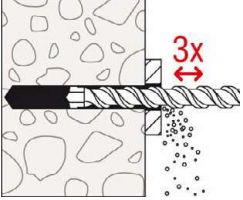
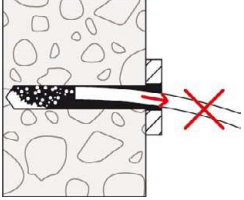
## Installation instructions: Drilling and cleaning the hole

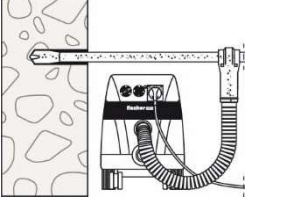
### Types of drills and cleaning

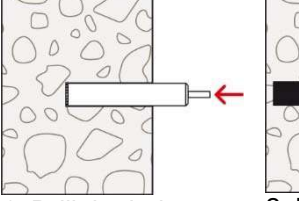
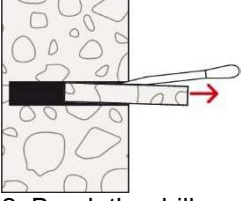
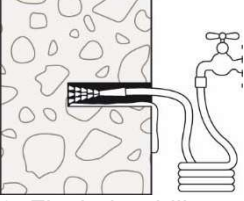
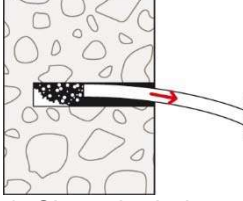
<p>Hammer drill (e.g. fischer Quattric II) with cleaning</p>		 <p>1: Drill the hole</p>	 <p>2: Clean the hole</p> <p>Continue with step 5</p>
<p>Hammer drill (e.g. fischer Quattric II) without cleaning</p>		 <p>1: Drill the hole</p> <p><math>h_{1,nc} = h_1 + 15 \text{ mm}</math></p>	 <p>2: When <math>h_{1,nc}</math> is reached: Pull out drill 3 x</p>  <p>Cleaning not necessary; Continue with step 5</p>
<p>Hollow drill (e.g. fischer FHD)</p>		 <p>1: Drill the hole with automatic cleaning (e.g. fischer FVC)</p>	 <p>2: Cleaning obsolete</p> <p>Continue with step 5</p>
<p>Diamond drill, for non seismic applications only</p>		 <p>1: Drill the hole</p>	 <p>2: Break the drill core and remove it</p>  <p>3: Flush the drill hole, until clear water emerges from the drill hole</p>  <p>4: Clean the hole</p>

fischer Bolt Anchor FAZ II Plus, FAZ II Plus R,  
FAZ II Plus HCR

**Intended Use**  
Installation instructions

**Annex B3**

Annex 9 / 19

# Installation instructions: Installation of the fastener

## HEXAGON NUT:

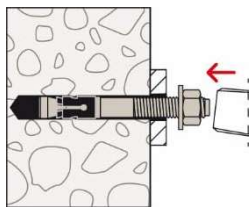

5.a: Set the fastener e.g. with hammer

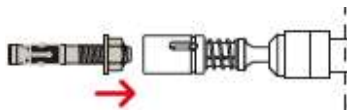

5.b: Set the fastener e.g. fischer FA-ST II

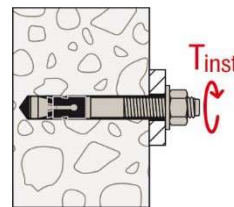

6: Apply  $T_{inst}$

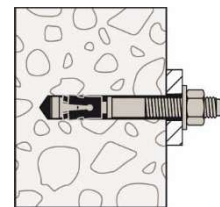

7: Installed fastener

## fischer FAZ II Plus DOME NUT:

Option 1: Push through installation with setting gauge SL-H:

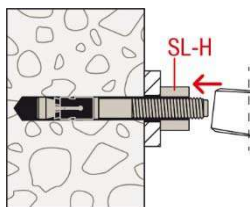

5.1: Set the fastener through the setting gauge and fixture

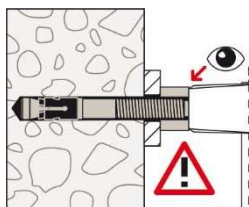

5.2: Check offset

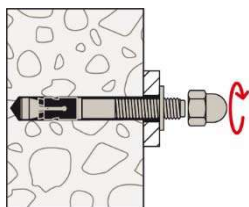

5.3: Turn on the fischer FAZ II Plus dome nut

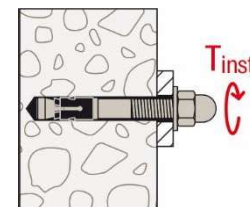

6: Apply  $T_{inst}$

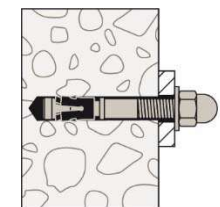

7: Installed fastener

Option 2: Push through installation with hexagon nut:

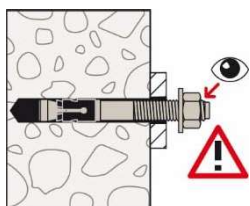

5.1: Check setting position: Visible one turn of a thread

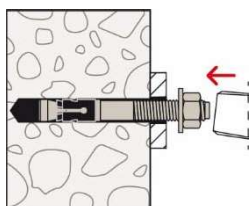

5.2: Set the fastener

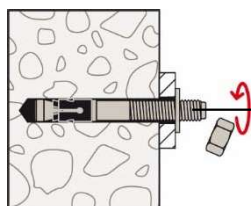

5.3: Remove nut

## fischer Filling conical washer FFD optional for seismic C2 application or minimising the annular gap:

Optional The gap between bolt and fixture may be filled with mortar (compressive strength  $\geq 50 \text{ N/mm}^2$  e.g. fischer FIS SB) after last step (for eliminating the annular gap). The FFD is additional to the standard washer. The thickness of the FFD must be considered for definition of  $t_{fix}$ . Countersunk of the FFD in direction to the anchor plate. Installation with hexagon nut or dome nut is permitted.

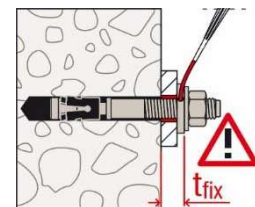
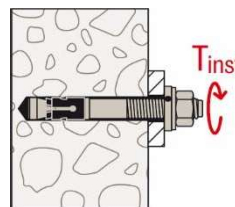
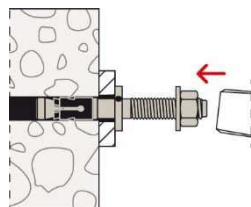

fischer Bolt Anchor FAZ II Plus, FAZ II Plus R, FAZ II Plus HCR

**Intended Use**  
Installation instructions

**Annex B4**

Annex 10 / 19

**Table C1.1: Characteristic values of tension resistance under static and quasi-static action**

Size		FAZ II Plus, FAZ II Plus R, FAZ II Plus HCR								
		M6	M8	M10	M12	M16	M20	M24		
<b>Steel failure</b>										
Characteristic resistance	FAZ II Plus	$N_{Rk,s}$ [kN]	11,3	19,9	32,7	49,3	78,7	108,4	180,0	
	FAZ II Plus R		12,1	21,0	34,5	52,0	83,0	127,6	187,0	
	FAZ II Plus HCR		11,3	17,6	29,1	43,8	69,9			
Partial factor for steel failure	FAZ II Plus	$\gamma_{Ms}^{1)}$ [-]	1,4					1,4	1,5	
	FAZ II Plus R							1,45		
	FAZ II Plus HCR		1,5	1,45		1,4	1,5			
<b>Pullout failure</b>										
Effective embedment depth for calculation	$h_{ef}$ [mm]		40-80	40 <sup>3)</sup> - < 45	45-90	40-100	50-125	65-160	100-180	125
Characteristic resistance in cracked concrete C20/25	$N_{Rk,p}$ (C20/25) [kN]		1,5	5,5	8	13	20	27,0	34,4	48,1
Characteristic resistance in uncracked concrete C20/25		10,5	14		20	22	38,6	49,2	68,8	
Increasing factor $\psi_c$ for cracked or uncracked concrete	$N_{Rk,p} = \psi_c \cdot N_{Rk,p}$ (C20/25)	[-]	C25/30	1,12						
			C30/37	1,22						
			C35/45	1,32						
			C40/50	1,41						
			C45/55	1,50						
			C50/60	1,58						
Installation sensitivity factor	$\gamma_{inst}$ [-]		1,0							
<b>Concrete cone and splitting failure</b>										
Factor for uncracked concrete	$k_{ucr,N}$ [-]		11,0 <sup>2)</sup>							
Factor for cracked concrete	$k_{cr,N}$ [-]		7,7 <sup>2)</sup>							
Characteristic spacing	$s_{cr,N}$ [mm]		$3 \cdot h_{ef}$							
Characteristic edge distance	$c_{cr,N}$ [mm]		$1,5 \cdot h_{ef}$							
Characteristic spacing for splitting failure	$s_{cr,sp}$ [mm]		$2 \cdot c_{cr,sp}$							
Characteristic edge distance for splitting failure h	$c_{cr,sp}$ [mm]	40	$\geq 80$	$2,4 \cdot h_{ef}$	$2 \cdot h_{ef}$	- <sup>5)</sup>				
			$\geq 100$	$2 \cdot h_{ef}$	$2,4 \cdot h_{ef}$					$2 \cdot h_{ef}$
			$\geq 120$		$1,9 \cdot h_{ef}$					$2,1 \cdot h_{ef}$
			$\geq 140$	$1,5 \cdot h_{ef}$						$2 \cdot h_{ef}$
			$\geq 160$							$2 \cdot h_{ef}$
$\geq 200$	$2,2 \cdot h_{ef}$									
Characteristic resistance to splitting	$N^0_{Rk,sp}$ [kN]		$\min \{N^0_{Rk,c}; N_{Rk,p}\}^{4)}$							

<sup>1)</sup> In absence of other national regulations

<sup>2)</sup> Based on concrete strength as cylinder strength

<sup>3)</sup> For dry internal exposure and statically indeterminate redundant components, the minimum effective embedment depth can be reduced to 35 mm without reduction of  $N_{Rk,p}$ .

<sup>4)</sup>  $N^0_{Rk,c}$  according to EN 1992-4:2018

<sup>5)</sup> No performance assessed

fischer Bolt Anchor FAZ II Plus, FAZ II Plus R, FAZ II Plus HCR

**Performances**

Characteristic values of tension resistance under static and quasi-static action

**Annex C1**

Annex 11 / 19

**Table C2.1: Characteristic values of shear resistance under static and quasi-static action**

Size		FAZ II Plus, FAZ II Plus R, FAZ II Plus HCR						
		M6	M8	M10	M12	M16	M20	M24
<b>Steel failure without lever arm</b>								
Characteristic resistance	FAZ II Plus without filling of the annular gap	7,5	16,3	26,2	37,0	68,4	82,9	128,3
	FAZ II Plus with filling		18,1	27,3	40,7	69,8	85,6	
	FAZ II Plus without filling R	8,8	17,6	26,5	42,1	71,1	107,9	158,1
	FAZ II Plus with filling R			27,6	44,3	73,6	117,9	
	FAZ II Plus without filling HCR		17,4	23,7	42,1	71,1	107,9	
	FAZ II Plus with filling HCR			27,9		73,6	117,9	
Partial factor for steel failure	$\gamma_{Ms}^{1)}$	1,25						
Factor for ductility	$k_7$	1,0						
<b>Steel failure with lever arm and Concrete pryout failure</b>								
Effective embedment depth for calculation	$h_{ef}$ [mm]	40-80	45-90	60-100	70-125	85-160	100-180	125
Characteristic bending resistance	FAZ II Plus	11	30	60	105	266	422	864
	FAZ II Plus R		29	59	100	256	519	898
	FAZ II Plus HCR							
Factor for pryout failure	$k_8$ [-]	2,6	2,8	3,2				
Effective embedment depth for calculation	$h_{ef}$ [mm]	- <sup>2)</sup>	40 <sup>3)</sup> - < 45	40 - < 60	50 - < 70	65 - < 85	- <sup>2)</sup>	
Characteristic bending resistance	FAZ II Plus		27	56	105	251		
	FAZ II Plus R		29	59	100	256		
	FAZ II Plus HCR		24	50		223		
Factor for pryout failure	$k_8$ [-]	2,5	2,6	3,1	3,2			
Partial factor for steel failure	$\gamma_{Ms}^{1)}$	1,25						
Factor for ductility	$k_7$	1,0						
<b>Concrete edge failure</b>								
Effective embedment depth for calculation	$l_f$ [mm]	$h_{ef}$						
Outside diameter of a fastener	$d_{nom}$	6	8	10	12	16	20	24
<p>1) In absence of other national regulations</p> <p>2) No performance assessed</p> <p>3) For dry internal exposure and statically indeterminate redundant components, the minimum effective embedment depth can be reduced to 35 mm without reduction of <math>N_{Rk,p}</math>.</p>								
fischer Bolt Anchor FAZ II Plus, FAZ II Plus R, FAZ II Plus HCR  <b>Performances</b> Characteristic values of shear resistance under static and quasi-static action						<b>Annex C2</b> Annex 12 / 19		

**Table C3.1: Characteristic values of tension resistance under fire exposure**

Size			FAZ II Plus, FAZ II Plus R, FAZ II Plus HCR																					
			M6		M8		M10		M12		M16		M20		M24									
h <sub>ef</sub> ≥ [mm]			40		35   45		40   60		50   70		65   85		100		125									
Characteristic resistance steel failure	FAZ II Plus	N <sub>Rk,s,fi</sub>	R30	0,6 <sup>1)</sup> / 0,9 <sup>2)</sup>		1,4		2,8		5,0		9,4		14,7		21,1								
			R60	0,4 <sup>1)</sup> / 0,9 <sup>2)</sup>		1,2		2,3		4,1		7,7		12,0		17,3								
			R90	0,3 <sup>1)</sup> / 0,9 <sup>2)</sup>		0,9		1,9		3,2		6,0		9,4		13,5								
			R120	0,2 <sup>1)</sup> / 0,7 <sup>2)</sup>		0,8		1,6		2,8		5,2		8,1		11,6								
	FAZ II Plus R / HCR	N <sub>Rk,s,fi</sub>	R30	0,6 <sup>1)</sup> / 0,9 <sup>2)</sup>		3,6		7,8		11,5		21,8		34,3		49,4								
			R60	0,4 <sup>1)</sup> / 0,9 <sup>2)</sup>		2,3		4,8		7,1		13,2		20,7		29,3								
			R90	0,3 <sup>1)</sup> / 0,9 <sup>2)</sup>		1,9		3,8		5,7		10,5		18,3		26,4								
			R120 [kN]	0,2 <sup>1)</sup> / 0,7 <sup>2)</sup>		1,6		3,3		4,9		8,6		17,3		25,0								
Characteristic resistance Concrete cone failure	N <sub>Rk,c,fi</sub>	R30 - R90	$7,7 \cdot h_{ef}^{1,5} \cdot (20)^{0,5} \cdot h_{ef} / 200 / 1000$																					
		R120	$7,7 \cdot h_{ef}^{1,5} \cdot (20)^{0,5} \cdot h_{ef} / 200 / 1000 \cdot 0,8$																					
		R30																						
Characteristic resistance pullout failure	N <sub>Rk,p,fi</sub>	R60	0,4		0,9		2,0		2,2		3,3		3,0		5,0		4,5		6,8		8,6		12,0	
		R90			0,8																			
		R120	0,3		0,5		1,6		1,7		2,6		2,4		4,0		3,6		5,4		6,9		9,6	

**Table C3.2: Characteristic values of shear resistance under fire exposure**

FAZ II Plus			R30		R60					
			V <sub>Rk,s,fi,30</sub> [kN]	M <sup>0</sup> <sub>Rk,s,fi,30</sub> [Nm]	V <sub>Rk,s,fi,60</sub> [kN]	M <sup>0</sup> <sub>Rk,s,fi,60</sub> [Nm]				
M6	40	h <sub>ef</sub> ≥ [mm]	0,6 <sup>1)</sup> / 0,9 <sup>2)</sup>		0,5 <sup>1)</sup> / 0,2 <sup>2)</sup>		0,4 <sup>1)</sup> / 0,9 <sup>2)</sup>		0,3 <sup>1)</sup> / 0,1 <sup>2)</sup>	
M8	35		1,8		1,4		1,6		1,2	
M10	40		3,6		3,6		2,9		3,0	
M12	50		6,3		7,8		4,9		6,4	
M16	65		11,7		19,9		9,1		16,3	
M20	100		18,2		39,0		14,2		31,8	
M24	125		26,3		67,3		20,5		55,0	
FAZ II Plus			R90		R120					
			V <sub>Rk,s,fi,90</sub> [kN]	M <sup>0</sup> <sub>Rk,s,fi,90</sub> [Nm]	V <sub>Rk,s,fi,120</sub> [kN]	M <sup>0</sup> <sub>Rk,s,fi,120</sub> [Nm]				
M6	40	h <sub>ef</sub> ≥ [mm]	0,3 <sup>1)</sup> / 0,9 <sup>2)</sup>		0,2 <sup>1)</sup> / 0,1 <sup>2)</sup>		0,2 <sup>1)</sup> / 0,7 <sup>2)</sup>		0,2 <sup>1)</sup> / 0,1 <sup>2)</sup>	
M8	35		1,3		1,0		1,2		0,8	
M10	40		2,2		2,4		1,9		2,1	
M12	50		3,5		5,0		2,8		4,3	
M16	65		6,6		12,6		5,3		11,0	
M20	100		10,3		24,6		8,3		21,4	
M24	125		14,8		42,6		11,9		37,0	

Concrete pryout failure according to EN 1992-4:2018

<sup>1)</sup> FAZ II Plus

<sup>2)</sup> FAZ II Plus R / FAZ II Plus HCR

fischer Bolt Anchor FAZ II Plus, FAZ II Plus R,  
FAZ II Plus HCR

**Performances**

Characteristic values of resistance under fire exposure

**Annex C3**

Annex 13 / 19

**Table C4.1: Characteristic values of shear resistance under fire exposure**

FAZ II Plus R, FAZ II Plus HCR			R30		R60	
			$V_{Rk,s,fi,30}$ [kN]	$M^0_{Rk,s,fi,30}$ [Nm]	$V_{Rk,s,fi,60}$ [kN]	$M^0_{Rk,s,fi,60}$ [Nm]
M6	hef ≥	40	0,6 <sup>1)</sup> / 0,9 <sup>2)</sup>	0,5 <sup>1)</sup> / 0,2 <sup>2)</sup>	0,4 <sup>1)</sup> / 0,9 <sup>2)</sup>	0,3 <sup>1)</sup> / 0,1 <sup>2)</sup>
M8		35	3,6	3,7	2,3	2,4
M10		40	7,8	10,1	4,8	6,2
M12		50	11,5	17,9	7,1	11,1
M16		65	21,8	46,2	13,2	27,9
M20		100	34,3	90,9	20,7	54,9
M24		125	49,4	157,2	29,3	93,1

FAZ II Plus R, FAZ II Plus HCR			R90		R120	
			$V_{Rk,s,fi,90}$ [kN]	$M^0_{Rk,s,fi,90}$ [Nm]	$V_{Rk,s,fi,120}$ [kN]	$M^0_{Rk,s,fi,120}$ [Nm]
M6	hef ≥	40	0,3 <sup>1)</sup> / 0,9 <sup>2)</sup>	0,2 <sup>1)</sup> / 0,1 <sup>2)</sup>	0,2 <sup>1)</sup> / 0,7 <sup>2)</sup>	0,2 <sup>1)</sup> / 0,1 <sup>2)</sup>
M8		35	1,9	1,9	1,6	1,7
M10		40	3,8	4,9	3,3	4,3
M12		50	5,7	8,8	4,9	7,6
M16		65	10,5	22,1	8,6	18,3
M20		100	18,3	48,6	17,3	45,9
M24		125	26,4	84,0	25,0	79,4

<sup>1)</sup> FAZ II Plus

<sup>2)</sup> FAZ II Plus R / FAZ II Plus HCR

Concrete pryout failure according to EN 1992-4:2018

**Table C4.2: Minimum spacings and minimum edge distances of fasteners under fire exposure for tension and shear load**

Size	FAZ II Plus, FAZ II Plus R, FAZ II Plus HCR						
	M6	M8	M10	M12	M16	M20	M24
Spacing $s_{min}$	Annex C5						
Edge distance $c_{min}$ [mm]	$c_{min} = 2 \cdot h_{ef}$ , for fire exposure from more than one side $c_{min} \geq 300$ mm						

fischer Bolt Anchor FAZ II Plus, FAZ II Plus R,  
FAZ II Plus HCR

**Performances**

Characteristic values of resistance under fire exposure

**Annex C4**

Annex 14 / 19



**Table C5.1:** Minimum thickness of concrete members, minimum spacing and minimum edge distance

Size	FAZ II Plus, FAZ II Plus R, FAZ II Plus HCR							
	M6	M8	M10	M12	M16	M20	M24	
<b>Minimum edge distance</b>								
Uncracked concrete	40	40	45	55	65	95	135	
Cracked concrete						85	100	
Corresponding	s [mm] according to Annex C6							
Minimum thickness of concrete member	80		100	140	160	200		
Thickness of concrete member	h ≥ max. {h <sub>min</sub> ; 1,5 · h <sub>ef</sub> ; h <sub>1</sub> <sup>1)</sup> + 25}				max. {h <sub>min</sub> ; 1,5 · h <sub>ef</sub> ; h <sub>1</sub> <sup>1)</sup> + 30}			
<b>Minimum spacing</b>								
Uncracked concrete	35	40	40	50	65	95	100	
Cracked concrete		35						
Corresponding	c [mm] according to Annex C6							
Minimum thickness of concrete member	80		100	140	160	200		
Thickness of concrete member	h ≥ max. {h <sub>min</sub> ; 1,5 · h <sub>ef</sub> ; h <sub>1</sub> + 25}				max. {h <sub>min</sub> ; 1,5 · h <sub>ef</sub> ; h <sub>1</sub> + 30}			
<b>Minimum splitting area</b>								
Uncracked concrete	A <sub>sp,req</sub> [·1000 mm <sup>2</sup> ]	5,1	18	37	54	67	100	117,5
Cracked concrete		1,5	12	27	40	50	77	87,5

<sup>1)</sup> If borehole cleaning is omitted, h<sub>1</sub> is replaced by h<sub>1,nc</sub>

**Table C5.2:** Minimum spacing and minimum edge distances - calculated values for **cracked concrete with one edge** (c<sub>2</sub> and c<sub>3</sub> ≥ 1,5 c<sub>1</sub>)

Type of anchor / size	FAZ II Plus, FAZ II Plus R, FAZ II Plus HCR											
	M6	M8	M10	M12	M16	M20	M24					
Effective anchorage depth	h <sub>ef</sub> ≥ [mm]	40	35	45	40	60	50	70	65	85	100	125
Minimum thickness of concrete member	h <sup>1)</sup> ≥ [mm]	80		85	80	120	100	140	140	180	160	200
Minimum spacing	S <sub>min</sub> [mm]	35		40	50	65	95	100				
	for c ≥ [mm]	40	100	65	120	80	100	75	130	115		
Minimum edge distance	c <sub>min</sub> [mm]	40	60	45	70	55	65	85	100			
	for s ≥ [mm]	35	160	90	190	125	165	85	230	140		

<sup>1)</sup> thickness of concrete member has to be increased by 15 mm, if borehole cleaning is omitted

fischer Bolt Anchor FAZ II Plus, FAZ II Plus R, FAZ II Plus HCR

**Performances**

Minimum thickness of member, minimum spacing and edge distances

**Annex C5**

Annex 15 / 19

## Determination of $A_{sp,ef}$ for each existing free edge

**Splitting failure** applied for minimum edge distance and spacing in depending on  $h_{ef}$

Definition Index:

cal = calculatory

e.g.:  $s_{x,y}$

x = load direction

y = number anchor plate

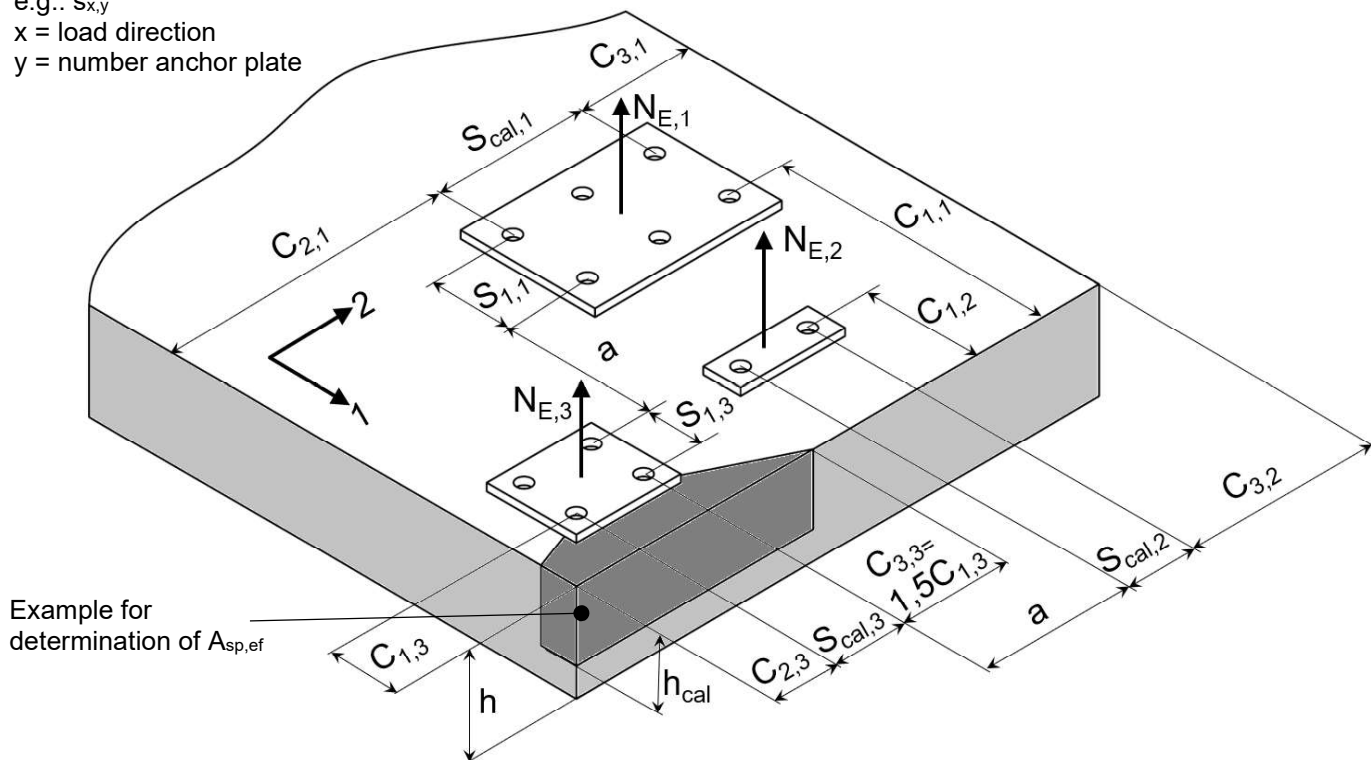

Example for different anchor plates: For considering all free edges the direction 1 and 2 must be swapped.

General formulation for each free edge:  $A_{sp,ef} = (C_2 + s_{cal} + C_3) \cdot h_{cal} \geq (n/2) \cdot A_{sp,req}$

with:

Edge distance  $C_1$ :  $C_{min} \leq C_1$

Edge distance  $C_2$ :  $C_{min} \leq C_2 \leq 1,5 \cdot C_1$

Edge distance  $C_3$ :  $C_{min} \leq C_3 \leq 1,5 \cdot C_1$

Calculation spacing, distance between outer anchors  $s_{cal}$ :  $s_{min} \leq s_{cal} \leq 3,0 \cdot C_1$

Distance between group of anchors  $a$ : For  $a \geq 3,0 c_1$  no influence between the anchor groups is taken into account.

Number of anchors  $n$  of an anchor plate as well close and parallel to the edge

Effective member thickness  $h_{cal}$ :  $h_{min} \leq h$ ;  $h_{cal} \leq h$ ;  $h_{cal} \leq (h_{ef} + 1,5 \cdot C_1)$

$c_1$ ,  $c_2$ ,  $c_3$ ,  $h$  and  $s_{cal}$  have to be set in way that the requirement is fulfilled

For the calculation of minimum spacing and minimum edge distance of fasteners in combination with different embedment depths and thicknesses of concrete members the following equation shall be fulfilled:

$$A_{sp,req} < A_{sp,ef}$$

$A_{sp,req}$  = required splitting area (according to Annex C 5)

$A_{sp,ef}$  = effective splitting area

(Figure not to scale)

fischer Bolt Anchor FAZ II Plus, FAZ II Plus R,  
FAZ II Plus HCR

### Performances

Minimum thickness of member, minimum spacings and edge distances

### Annex C6

Annex 16 / 19

**Table C7.1: Characteristic values of tension and shear resistance under seismic action category C1**

Size	FAZ II Plus, FAZ II Plus R, FAZ II Plus HCR									
	M6	M8		M10	M12	M16	M20	M24		
Effective embedment depth $h_{ef}$ [mm]	- 2)	40 - <45	45-90	40-100	50-125	85-160	100-180	125		
With filling of the annular gap		1,0								
Without filling of the annular gap $\alpha_{gap}$ [-]		0,5								
<b>Steel failure <math>N_{Rk,s,C1} = N_{Rk,s}</math>; <math>\gamma_{Ms,C1} = \gamma_{Ms}</math> (see Annex C1)</b>										
<b>Pullout failure</b>										
Characteristic resistance in cracked concrete C1 $N_{Rk,p,C1}$ [kN]	- 2)	5,1	7,4	11,6	20,0	27,0	34,4	48,1		
Installation sensitivity factor $\gamma_{Inst}$ [-]		1,0								
<b>Concrete cone failure and splitting failure <math>N_{Rk,c,C1} = N_{Rk,c}</math>; <math>N_{Rk,sp,C1} = N_{Rk,sp}</math> (see Annex C1)</b>										
<b>Steel failure without lever arm</b>										
<b>FAZ II Plus</b>										
Characteristic resistance C1	$h_{ef}$ [mm]	Without filling $V_{Rk,s,C1}$ [kN]	- 2)	45-90	60-100	70-125	85-160	100-180	125	
				14,8	23,6	33,3	58,1	71,2	102,6	
	$h_{ef}$ [mm]	With filling $V_{Rk,s,C1}$ [kN]	- 2)	16,5	24,6	39,9	59,3	85,6		-
				40-<45	40-<60	50-<70	- 2)			
	$h_{ef}$ [mm]	Without filling $V_{Rk,s,C1}$ [kN]	- 2)	- 2)			- 2)			
				32,9			-			
	$h_{ef}$ [mm]	With filling $V_{Rk,s,C1}$ [kN]	- 2)	15,6	19,7	39,9	-			
				<b>FAZ II Plus R</b>						
	Characteristic resistance C1	$h_{ef}$ [mm]	Without filling $V_{Rk,s,C1}$ [kN]	- 2)	45-90	60-100	70-125	85-160	100-180	125
					16,0	23,9	37,9	60,4	86,3	126,5
		$h_{ef}$ [mm]	With filling $V_{Rk,s,C1}$ [kN]	- 2)	24,8	43,4	62,6	94,3	-	
					40-<45	40-<60	50-<70	- 2)		
$h_{ef}$ [mm]		Without filling $V_{Rk,s,C1}$ [kN]	- 2)	- 2)			- 2)			
				37,5			-			
$h_{ef}$ [mm]		With filling $V_{Rk,s,C1}$ [kN]	- 2)	15,1	19,9	43,4	-			
				<b>FAZ II Plus HCR</b>						
Characteristic resistance C1		$h_{ef}$ [mm]	Without filling $V_{Rk,s,C1}$ [kN]	- 2)	45-90	60-100	70-125	85-160	100-180	125
					15,8	21,3	37,9	60,4	86,3	126,5
		$h_{ef}$ [mm]	With filling $V_{Rk,s,C1}$ [kN]	- 2)	25,1	41,3	62,6	94,3	-	
					40-<45	40-<60	50-<70	- 2)		
	$h_{ef}$ [mm]	Without filling $V_{Rk,s,C1}$ [kN]	- 2)	- 2)			- 2)			
				37,5			-			
	$h_{ef}$ [mm]	With filling $V_{Rk,s,C1}$ [kN]	- 2)	15,0	20,1	41,3	-			
				<b>Partial factor for steel failure <math>\gamma_{Ms,C1}^{1)}</math> [-]</b>						
	1,25									

1) In absence of other national regulations

2) No performance assessed

fischer Bolt Anchor FAZ II Plus, FAZ II Plus R, FAZ II Plus HCR

**Performances**

Characteristic values of tension and shear resistance under seismic action category C1

**Annex C7**

**Table C8.1: Characteristic values of tension and shear resistance under seismic action category C2**

Size		FAZ II Plus, FAZ II Plus R, FAZ II Plus HCR							
		M6	M8	M10	M12	M16	M20	M24	
With filling of the annular gap	$\alpha_{gap}$ [-]	-2)		1,0					
Without filling of the annular gap				0,5					
<b>Steel failure <math>N_{Rk,s,C2} = N_{Rk,s}</math>; <math>\gamma_{Ms,C2} = \gamma_{Ms}</math> (see Annex C1)</b>									
<b>Pullout failure</b>									
Characteristic resistance in cracked concrete C2	$h_{ef}$ [mm]	-2)	60-100	70-125	85-160	100-180	125		
	$N_{Rk,p,C2}$ [kN]		5,1	7,4	21,5	30,7	39,6		
	$h_{ef}$ [mm]		40 - <60	50 - <70	65 - <85	-2)			
	$N_{Rk,p,C2}$ [kN]		2,7	4,4	16,4				
Installation sensitivity factor	$\gamma_{inst}$ [-]	1,0							
<b>Concrete cone failure and splitting failure <math>N_{Rk,c,C2} = N_{Rk,c}</math>; <math>N_{Rk,sp,C2} = N_{Rk,sp}</math> (see Annex C1)</b>									
<b>Steel failure without lever arm</b>									
<b>FAZ II Plus</b>									
Characteristic resistance C2	$h_{ef}$ [mm]	-2)	60-100	70-125	85-160	100-180	125		
	Without filling $V_{Rk,s,C2}$ [kN]		17,6	27,8	37,6	62,2	70,6		
	With filling $V_{Rk,s,C2}$ [kN]		20,5	30,5	52,4	68,5	102,6		
	$h_{ef}$ [mm]		40 - <60	50 - <70	65 - <85	-2)			
	Without filling $V_{Rk,s,C2}$ [kN]		14,1	24,4	31,2				
	With filling $V_{Rk,s,C2}$ [kN]		14,7	30,5	52,4				
	<b>FAZ II Plus R</b>								
	$h_{ef}$ [mm]		-2)	60-100	70-125	85-160	100-180	125	
	Without filling $V_{Rk,s,C2}$ [kN]			17,8	31,6	39,1	70,5	87,0	
	With filling $V_{Rk,s,C2}$ [kN]			20,7	33,2	55,2	104,9	126,5	
$h_{ef}$ [mm]	40 - <60	50 - <70		65 - <85	-2)				
Without filling $V_{Rk,s,C2}$ [kN]	14,3	27,8		32,4					
With filling $V_{Rk,s,C2}$ [kN]	14,9	33,2		55,2					
<b>FAZ II Plus HCR</b>									
$h_{ef}$ [mm]	-2)	60-100		70-125	85-160	100-180	125		
Without filling $V_{Rk,s,C2}$ [kN]		15,9		31,6	39,1	70,5	87,0		
With filling $V_{Rk,s,C2}$ [kN]		20,9			55,2	104,9	126,5		
$h_{ef}$ [mm]		40 - <60	50 - <70	65 - <85	-2)				
Without filling $V_{Rk,s,C2}$ [kN]		12,8	27,8	32,4					
With filling $V_{Rk,s,C2}$ [kN]		15,1	31,6	55,2					
Partial factor for steel		$\gamma_{Ms,C2}^{1)}$ [-]	1,25						

1) In absence of other national regulations

2) No performance assessed

fischer Bolt Anchor FAZ II Plus, FAZ II Plus R, FAZ II Plus HCR

**Performances**

Characteristic values of resistance under tension and shear loads under seismic action category C2

**Annex C8**

Annex 18 / 19

**Table C9.1: Displacements** under static and quasi static **tension** loads

Size	FAZ II Plus, FAZ II Plus R, FAZ II Plus HCR						
	M6	M8	M10	M12	M16	M20	M24
<b>Displacement – factor for tensile load<sup>1)</sup></b>							
$\delta_{N0}$ - factor	0,13	0,22	0,12	0,09	0,08	0,07	0,05
$\delta_{N\infty}$ - factor	1,00	0,78	0,40	0,19	0,09		0,07
$\delta_{N0}$ - factor	0,16	0,07	0,05	0,06		0,05	0,04
$\delta_{N\infty}$ - factor	0,24	0,29	0,21	0,14	0,10	0,06	0,05

**Table C9.2: Displacements** under static and quasi static **shear** loads

Size	FAZ II Plus, FAZ II Plus R, FAZ II Plus HCR						
	M6	M8	M10	M12	M16	M20	M24
<b>Displacement – factor for shear load<sup>2)</sup></b>							
<b>FAZ II Plus</b>							
$\delta_{V0}$ - factor	0,6	0,35	0,37	0,27	0,10	0,09	0,07
$\delta_{V\infty}$ - factor	0,9	0,52	0,55	0,40	0,14	0,15	0,11
<b>FAZ II Plus R, FAZ II Plus HCR</b>							
$\delta_{V0}$ - factor	0,6	0,23	0,19	0,18	0,10	0,11	0,07
$\delta_{V\infty}$ - factor	0,9	0,35	0,29	0,27	0,15	0,17	0,11

<sup>1)</sup> Calculation of effective displacement:

$$\delta_{N0} = \delta_{N0} - \text{factor} \cdot N$$

$$\delta_{N\infty} = \delta_{N\infty} - \text{factor} \cdot N$$

N = Action tension loading

<sup>2)</sup> Calculation of effective displacement:

$$\delta_{V0} = \delta_{V0} - \text{factor} \cdot V$$

$$\delta_{V\infty} = \delta_{V\infty} - \text{factor} \cdot V$$

V = Action shear loading

**Table C9.3: Displacements** under **tension** loads for **category C2** for all embedment depths

Size	FAZ II Plus, FAZ II Plus R, FAZ II Plus HCR						
	M6	M8	M10	M12	M16	M20	M24
DLS $\delta_{N,C2(DLS)}$	- <sup>1)</sup>		2,7	4,4		5,6	4,8
ULS $\delta_{N,C2(ULS)}$	- <sup>1)</sup>		11,5	13,0	12,3	14,4	15,2

<sup>1)</sup> No performance assessed

**Table C9.4: Displacements** under **shear** loads for **category C2** for all embedment depths

Size	FAZ II Plus, FAZ II Plus R, FAZ II Plus HCR						
	M6	M8	M10	M12	M16	M20	M24
DLS without filling $\delta_{V,C2(DLS)}$	- <sup>1)</sup>		5,0			4,8	4,2
ULS without filling $\delta_{V,C2(ULS)}$	- <sup>1)</sup>		7,8	6,3	8,8	6,3	7,4
DLS with filling $\delta_{V,C2(DLS)}$	- <sup>1)</sup>		1,2			2,0	4,2
ULS with filling $\delta_{V,C2(ULS)}$	- <sup>1)</sup>		4,2	5,8	3,1	4,4	7,4

<sup>1)</sup> No performance assessed

fischer Bolt Anchor FAZ II Plus, FAZ II Plus R,  
FAZ II Plus HCR

**Performances**

Displacements under tension and shear loads

**Annex C9**

Annex 19 / 19