

## VYHLÁSENIE O PARAMETROCH

### DoP 0362

pre fischer chemický kotviaci systém fischer RM II (Lepená kotva na použitie v betóne)

SK

- Jedinečný identifikačný kód typu výrobku: **DoP 0362**
- Zamýšľané použitie/použitia: **Dodatočné upevnenie v betóne s trhlinami alebo v betóne bez trhlín, pozri prílohu, najmä prílohy B1 - B7.**
- Výrobca: **fischerwerke GmbH & Co. KG, Otto-Hahn-Straße 15, 79211 Denzlingen, Nemecko**
- Spĺnomocnený zástupca: **-**
- Systém(-y) posudzovania a overovania nemennosti parametrov: **1**
- Európsky hodnotiaci dokument: **EAD 330499-01-0601, Edition 04/2020**  
Európske technické posúdenie: **ETA-16/0340; 2024-04-16**  
Orgán technického posudzovania: **DIBt- Deutsches Institut für Bautechnik**  
Notifikovaný(-é) subjekt(-y): **2873 TU Darmstadt**
- Deklarované parametre:  
**Mechanická odolnosť a stabilita (BWR 1)**  
**Charakteristická odolnosť v ťahu (statické a kvázistatické zaťaženie):**  
Odolnosť voči porušeniu ocele: Prílohy C1, C2  
Odolnosť voči kombinácii porušením vytiahnutím a porušením betónového kužela: Prílohy C4, C5  
Odolnosť voči porušeniu betónového kužela: Príloha C3  
Vzdialenosť od okraja voči rozštiepiu pri zaťažení: Príloha C3  
Robustnos: Prílohy C3 - C5  
Maximálny ťahovací moment: Prílohy B3, B4  
Minimálna vzdialenosť od okraj a osová vzdialenosť: Prílohy B3, B4  
**Charakteristická odolnosť v šmyku (statické a kvázistatické zaťaženie):**  
Odolnosť voči porušeniu ocele: Prílohy C1, C2  
Odolnosť voči vylomeniu: Príloha C3  
Odolnosť voči poškodeniu hrany betónu: Príloha C3  
**Posuny pri krátkodobom a dlhodobom zaťažení:**  
Posuny pri krátkodobom a dlhodobom zaťažení: Príloha C6  
**Charakteristická odolnosť a posuny pre seizmické výkonnostné kategórie C1 a C2:**  
Odolnosť pri zatažení ťahom, posuny, kategória C1: NPD  
Odolnosť pri zatažení ťahom, posuny, kategória C2: NPD  
Odolnosť pri zatažení šmykom, posuny, kategória C1: NPD  
Odolnosť pri zatažení šmykom, posuny, kategória C2: NPD  
Faktor prstencovej medzery: NPD  
**Hygiena, zdravie a životné prostredie (BWR 3)**  
Obsah, emisie a / alebo uvoľňovanie nebezpečných látok: NPD
- Vhodná technická dokumentácia a/alebo špecifická technická dokumentácia: **-**

Uvedené parametre výrobku sú v zhode so súborom deklarovanych parametrov. Toto vyhlásenie o parametroch sa v súlade s nariadením (EÚ) č. 305/2011 vydáva na výhradnú zodpovednosť uvedeného výrobcu.

Podpísal(-a) za a v mene výrobcu:



Dr.-Ing. Oliver Geibig, konateľ oddelenia Produkt management & vývoj  
Tumlingen, 2024-05-06



Jürgen Grün, konateľ oddelenia Chemická výroba & kvalita

Toto vyhlásenie o vlastnostiach bolo vyhotovené v rôznych jazykoch. V prípade, že dôjde k rozdielnemu výkladu má anglická verzia vždy prednosť.

Príloha obsahuje dobrovoľné a doplňujúce informácie v anglickom jazyku. Tieto vychádzajú zo zákonom stanovených požiadaviek (jazykovo neutrálnych).

Translation guidance Essential Characteristics and Performance Parameters for Annexes

**Základné charakteristiky a parametre výkonu – pokyny na preklad pre prílohy**

Mechanical resistance and stability (BWR 1)		
Mechanická odolnosť a stabilita (BWR 1)		
Characteristic resistance to tension load (static and quasi-static loading):		
<b>Charakteristická odolnosť v ťahu (statické a kvázistatické zaťaženie):</b>		
1	Resistance to steel failure: <b>Odolnosť voči porušeniu ocele:</b>	$N_{Rk,s}$ [kN]
2	Resistance to combined pull-out and concrete cone failure: <b>Odolnosť voči kombinácii porušením vyťahnutím a porušením betónového kužela:</b>	$T_{Rk}$ and/or $T_{Rk,100}$ [N/mm <sup>2</sup> ], $\psi_{sus}^0$ [-] (BF) $N_{Rk,p}$ and/or $N_{Rk,p,100}$ [kN] (BEF)
3	Resistance to concrete cone failure: <b>Odolnosť voči porušeniu betónového kužela:</b>	$c_{cr,N}$ [mm], $k_{cr,N}$ , $k_{ucr,N}$ [-]
4	Edge distance to prevent splitting under load: <b>Vzdialenosť od okraja voči rozštiepniu pri zaťažení:</b>	$c_{cr,sp}$ [mm]
5	Robustness: <b>Robustnos:</b>	$\gamma_{inst}$ [-]
6	Maximum installation torque: <b>Maximálny uťahovací moment:</b>	max $T_{inst}$ [Nm] (BF)
	Installation torque: <b>Uťahovací moment:</b>	$T_{inst}$ [Nm] (BEF)
7	Minimum edge distance and spacing: <b>Minimálna vzdialenosť od okraj a osová vzdialenosť:</b>	$c_{min}$ , $s_{min}$ , $h_{min}$ [mm]
Characteristic resistance to shear load (static and quasi-static loading):		
<b>Charakteristická odolnosť v šmyku (statické a kvázistatické zaťaženie):</b>		
8	Resistance to steel failure: <b>Odolnosť voči porušeniu ocele:</b>	$V_{Rk,s}^0$ [kN], $M_{Rk,s}^0$ [Nm], $k_7$ [-]
9	Resistance to pry-out failure: <b>Odolnosť voči vylomeniu:</b>	$k_8$ [-]
10	Resistance to concrete edge failure: <b>Odolnosť voči poškodeniu hrany betónu:</b>	$d_{nom}$ , $l_f$ [mm]
Displacements under short-term and long-term loading:		
<b>Posuny pri krátkodobom a dlhodobom zaťažení:</b>		
11	Displacements under short-term and long-term loading: <b>Posuny pri krátkodobom a dlhodobom zaťažení:</b>	$\delta_0$ , $\delta_\infty$ [mm or mm/(N/mm <sup>2</sup> )]
Characteristic resistance and displacements for seismic performance categories C1 and C2:		
<b>Charakteristická odolnosť a posuny pre seizmické výkonnostné kategórie C1 a C2:</b>		
12	Resistance to tension load, displacements:	
	<b>Odolnosť pri zaťažení ťahom, posuny, kategória C1:</b>	C1 $N_{Rk,s,C1}$ [kN] (all) $T_{Rk,C1}$ [N/mm <sup>2</sup> ] (BF) $N_{Rk,p,C1}$ [kN] (BEF)
	<b>Odolnosť pri zaťažení ťahom, posuny, kategória C2:</b>	C2 $N_{Rk,s,C2}$ [kN] (all) $T_{Rk,C2}$ [N/mm <sup>2</sup> ] (BF) $N_{Rk,p,C2}$ [kN] (BEF) $\delta_{N,C2}$ [mm] (all)
13	Resistance to shear load, displacements:	
	<b>Odolnosť pri zaťažení šmykom, posuny, kategória C1:</b>	C1 $V_{Rk,s,C1}$ [kN] (all)
	<b>Odolnosť pri zaťažení šmykom, posuny, kategória C2:</b>	C2 $V_{Rk,s,C2}$ [kN] (all) $\delta_{V,C2}$ [mm] (all)
14	Factor annular gap: <b>Faktor prstencovej medzery:</b>	$\alpha_{gap}$ [-]
Hygiene, health and the environment (BWR 3)		
<b>Hygiena, zdravie a životné prostredie (BWR 3)</b>		
15	Content, emission and/or release of dangerous substances: <b>Obsah, emisie a / alebo uvoľňovanie nebezpečných látok:</b>	-

## Specific Part

### 1 Technical description of the product

The fischer capsule system RM II is a bonded anchor for use in concrete consisting of a capsule RM II and a steel element according to Annex A2.

The capsule RM II is placed in the hole and the steel element is driven by machine with simultaneous hammering and turning.

The anchor rod is anchored via the bond between steel element, chemical mortar and concrete.

The product description is given in Annex A.

### 2 Specification of the intended use in accordance with the applicable European Assessment Document

The performances given in Section 3 are only valid if the anchor is used in compliance with the specifications and conditions given in Annex B.

The verifications and assessment methods on which this European Technical Assessment is based lead to the assumption of a working life of the anchor of at least 50 years. The indications given on the working life cannot be interpreted as a guarantee given by the producer, but are to be regarded only as a means for choosing the right products in relation to the expected economically reasonable working life of the works.

### 3 Performance of the product and references to the methods used for its assessment

#### 3.1 Mechanical resistance and stability (BWR 1)

Essential characteristic	Performance
Characteristic resistance to tension load (static and quasi-static loading)	See Annex B 3 and B 4, C 1 to C 5
Characteristic resistance to shear load (static and quasi-static loading)	See Annex C 1 to C 4
Displacements under short-term and long-term loading	See Annex C 6
Characteristic resistance and displacements for seismic performance categories C1 and C2	No performance assessed

#### 3.2 Hygiene, health and the environment (BWR 3)

Essential characteristic	Performance
Content, emission and/or release of dangerous substances	No performance assessed

**4 Assessment and verification of constancy of performance (AVCP) system applied, with reference to its legal base**

In accordance with the European Assessment Document EAD 330499-01-0601 the applicable European legal act is: [96/582/EC].

The system to be applied is: 1

## Installation conditions

### fischer anchor rod RG M; installation in concrete

Pre-positioned installation:

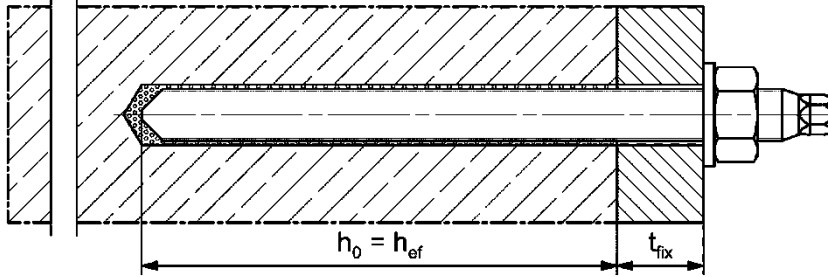

Pre-positioned installation with subsequently injected fischer filling disc:

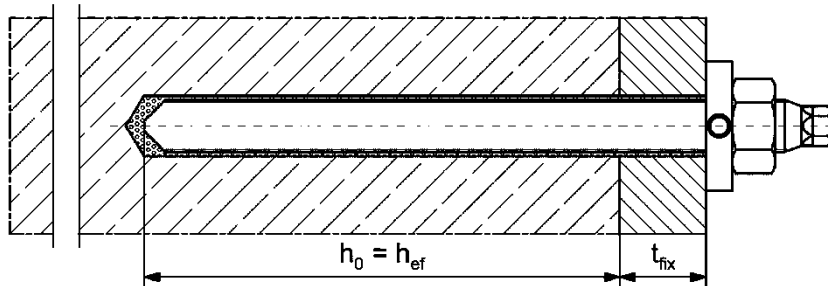

### fischer internal threaded anchor RG M I; installation in concrete

Pre-positioned installation:

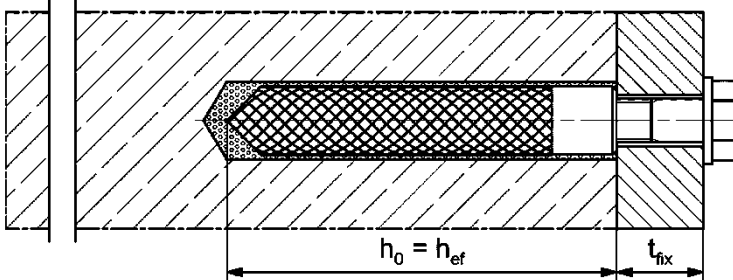

Pre-positioned installation with subsequently injected fischer filling disc:

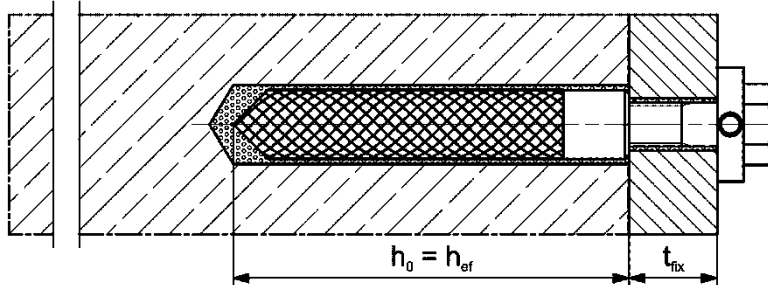

Pictures not to scale

$h_0$  = drill hole depth

$h_{ef}$  = effective anchorage depth

$t_{fix}$  = thickness of fixture

fischer RM II

Product description  
Installation conditions

**Annex A 1**

Appendix 3 / 18

# Overview product components

## Capsule RM II

Size: 8, 10, 12, 16, 16E, 20/22, 24



## fischer anchor rod RG M

Size: M8, M10, M12, M16, M20, M24

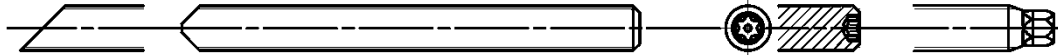

## fischer internal threaded anchor RG M I

Size: M8, M10, M12, M16, M20



## Screw / threaded rod / washer / hexagon nut

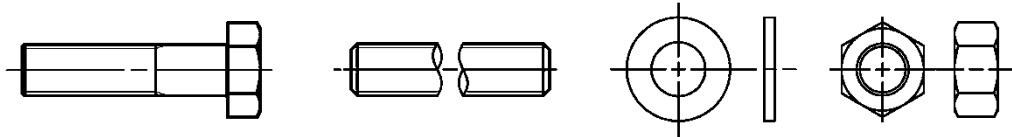

## fischer filling disc with injection adapter

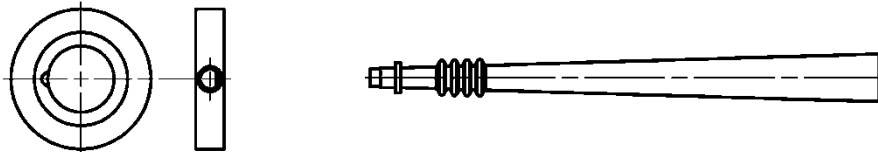

## fischer RM II – RG M Connector

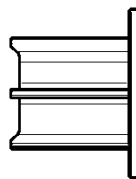

Size: M8, M10, M12, M16, M20, M24

Pictures not to scale

fischer RM II

**Product description**  
Overview product components

**Annex A 2**

Appendix 4 / 18

**Table A3.1: Materials**

Part	Designation	Material		
1	Capsule RM II	Mortar, hardener, filler		
	Steel grade	Steel	Stainless steel R	High corrosion resistant steel HCR
		zinc plated	acc. to EN 10088-1:2014 Corrosion resistance class CRC III acc. to EN 1993-1-4:2006+A1:2015	acc. to EN 10088-1:2014 Corrosion resistance class CRC V acc. to EN 1993-1-4:2006+A1:2015
2	Anchor rod	Property class 4.8, 5.8 or 8.8; EN ISO 898-1:2013 zinc plated $\geq 5 \mu\text{m}$ , ISO 4042:2022 or hot dip galvanised $\geq 40 \mu\text{m}$ EN ISO 10684:2004 $f_{uk} \leq 1000 \text{ N/mm}^2$	Property class 50, 70 or 80 EN ISO 3506-1:2020 1.4401; 1.4404; 1.4578; 1.4571; 1.4439; 1.4362; 1.4062, 1.4662, 1.4462 EN 10088-1:2014 $f_{uk} \leq 1000 \text{ N/mm}^2$	Property class 50 or 80 EN ISO 3506-1:2009 or property class 70 with $f_{yk} = 560 \text{ N/mm}^2$ 1.4565; 1.4529 EN 10088-1:2014 $f_{uk} \leq 1000 \text{ N/mm}^2$
		Fracture elongation $A_5 > 8 \%$ ,		
3	Washer ISO 7089:2000	zinc plated $\geq 5 \mu\text{m}$ , ISO 4042:2022 or hot dip galvanised $\geq 40 \mu\text{m}$ EN ISO 10684:2004	1.4401; 1.4404; 1.4578; 1.4571; 1.4439; 1.4362 EN 10088-1:2014	1.4565; 1.4529 EN 10088-1:2014
4	Hexagon nut	Property class 4, 5 or 8; EN ISO 898-2:2012 zinc plated $\geq 5 \mu\text{m}$ , ISO 4042:2022 or hot dip galvanised $\geq 40 \mu\text{m}$ EN ISO 10684:2004	Property class 50, 70 or 80 EN ISO 3506-2:2020 1.4401; 1.4404; 1.4578; 1.4571; 1.4439; 1.4362 EN 10088-1:2014	Property class 50, 70 or 80 EN ISO 3506-2:2020 1.4565; 1.4529 EN 10088-1:2014
5	fischer internal threaded anchor RG M I	Property class 5.8 ISO 898-1:2013 zinc plated $\geq 5 \mu\text{m}$ , ISO 4042:2022	Property class 70 EN ISO 3506-1:2020 1.4401; 1.4404; 1.4578; 1.4571; 1.4439; 1.4362 EN 10088-1:2014	Property class 70 EN ISO 3506-1:2020 1.4565; 1.4529 EN 10088-1:2014
6	Commercial standard screw or threaded rod for fischer internal threaded anchor RG M I	Property class 5.8 or 8.8; EN ISO 898-1:2013 zinc plated $\geq 5 \mu\text{m}$ , ISO 4042:2022 fracture elongation $A_5 > 8 \%$	Property class 70 EN ISO 3506-1:2020 1.4401; 1.4404; 1.4578; 1.4571; 1.4439; 1.4362 EN 10088-1:2014 fracture elongation $A_5 > 8 \%$	Property class 70 EN ISO 3506-1:2020 1.4565; 1.4529 EN 10088-1:2014 fracture elongation $A_5 > 8 \%$
7	fischer filling disc similar to DIN 6319-G	zinc plated $\geq 5 \mu\text{m}$ , ISO 4042:2022 or hot dip galvanised $\geq 40 \mu\text{m}$ EN ISO 10684:2004	1.4401; 1.4404; 1.4578; 1.4571; 1.4439; 1.4362 EN 10088-1:2014	1.4565; 1.4529 EN 10088-1:2014



fischer RM II

Product description  
Materials**Annex A 3**

Appendix 5 / 18

# Specifications of intended use part 1

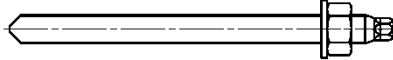
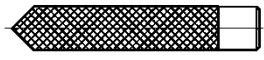
**Table B1.1: Overview use and performance categories**

Anchorages subject to		RM II with ...			
		fischer anchor rod RG M 	fischer internal threaded anchor RG M I 		
Hammer drilling with standard drill bit 		Manual or robotic-assisted by fischer BauBot all sizes		Manual all sizes	
Hammer drilling with hollow drill bit (fischer „FHD“, Heller "Duster Expert"; Bosch „Speed Clean“; Hilti "TE-CD, TE-YD", DreBo „D-Plus“, DreBo „D-Max“) 		Nominal drill bit diameter (d <sub>0</sub> ) 12 mm to 28 mm		all sizes	
Static and quasi static load, in	uncracked concrete	all sizes	Tables: C1.1, C3.1, C4.1, C6.1	all sizes	Tables: C2.1, C3.1, C5.1, C6.2
	cracked concrete	M10, M12, M16, M20, M24			
Use category	I1 dry or wet concrete	all sizes		all sizes	
	I2 flooded hole	M12, M16, M20, M24			
Installation direction		D3 (downward and horizontal and upwards (e.g. overhead) installation)			
Installation temperature		T <sub>i,min</sub> = -15 °C to T <sub>i,max</sub> = +40 °C			
In-service temperature	Temperature range I	-40 °C to +40 °C	(max. short term temperature +40 °C max. long term temperature +24 °C)		
	Temperature range II	-40 °C to +80 °C	(max. short term temperature +80 °C max. long term temperature +50 °C)		
	Temperature range III	-40 °C to +120 °C	(max. short term temperature +120 °C max. long term temperature +72 °C)		
fischer RM II		<b>Annex B 1</b> Appendix 6 / 18			
Intended Use Specifications part 1					



## Specifications of intended use part 2

### Base materials:

- Compacted reinforced or unreinforced normal weight concrete without fibres strength classes C20/25 to C50/60 according to EN 206:2013+A2:2021

### Use conditions (Environmental conditions):

- Structures subject to dry internal conditions (zinc coated steel, stainless steel or high corrosion resistant steel)
- For all other conditions according to EN1993-1-4:2006 + A1:2015 corresponding to corrosion resistance classes to Annex A 3 table A3.1.

### Design:

- Anchorages have to be designed by a responsible engineer with experience of concrete anchor design.
- Verifiable calculation notes and drawings are to be prepared taking account of the loads to be anchored. The position of the anchor is indicated on the design drawings (e.g. position of the anchor relative to reinforcement or to supports, etc.).
- Anchorages are designed in accordance with: EN 1992-4:2018 and EOTA Technical Report TR 055, Edition February 2018.

### Installation:

- Anchor installation has to be carried out by appropriately qualified personnel and under the supervision of the person responsible for technical matters of the site.
- For manual installation the anchorage depth should be marked and adhered to on installation.
- For robot-assisted installation using fischer BauBot, maintain the effective anchoring depth by selecting the appropriate installation program.
- Overhead installation is allowed.

fischer RM II

Intended Use  
Specifications part 2

**Annex B 2**

Appendix 7 / 18

**Table B3.1: Installation parameters for fischer anchor rods RG M**

Anchor rods RG M		thread	M8	M10	M12	M16	M20	M24
Nominal drill bit diameter	$d_0$	[mm]	10	12	14	18	25	28
Drill hole depth	$h_0$		$h_0 = h_{ef}$					
Effective embedment depth	$h_{ef}$		80	90	110	125	170	210
Minimum spacing and minimum edge distance	$s_{min} = c_{min}$		40	45	55	65	85	105
Diameter of pre-positioned clearance hole in the fixture anchorage	$d_f$		9	12	14	18	22	26
Minimum thickness of concrete member	$h_{min}$		$h_{ef} + 30$ ( $\geq 100$ )			$h_{ef} + 2d_0$		
Maximum installation torque	$\max T_{inst}$	[Nm]	10	20	40	60	120	150

**fischer anchor rod RG M**

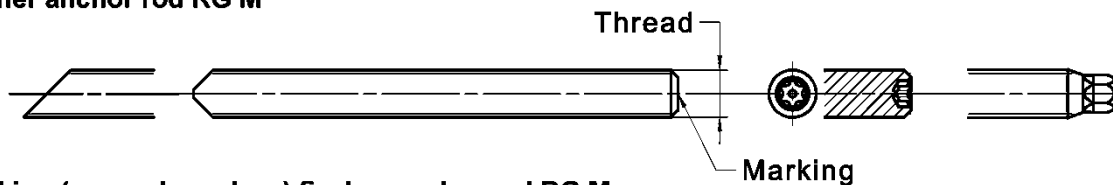

**Marking (on random place) fischer anchor rod RG M**

Steel zinc plated PC <sup>1)</sup> 8.8	• or +	Steel hot-dip PC <sup>1)</sup> 8.8	•
High corrosion resistant steel HCR PC <sup>1)</sup> 50	•	High corrosion resistant steel HCR PC <sup>1)</sup> 70	-
High corrosion resistant steel HCR PC <sup>1)</sup> 80	(	Stainless steel R property class 50	~
Stainless steel R property class 80	*		

Alternatively: Colour coding according to DIN 976-1:2016 <sup>1)</sup> PC = property class

**Installation conditions:**

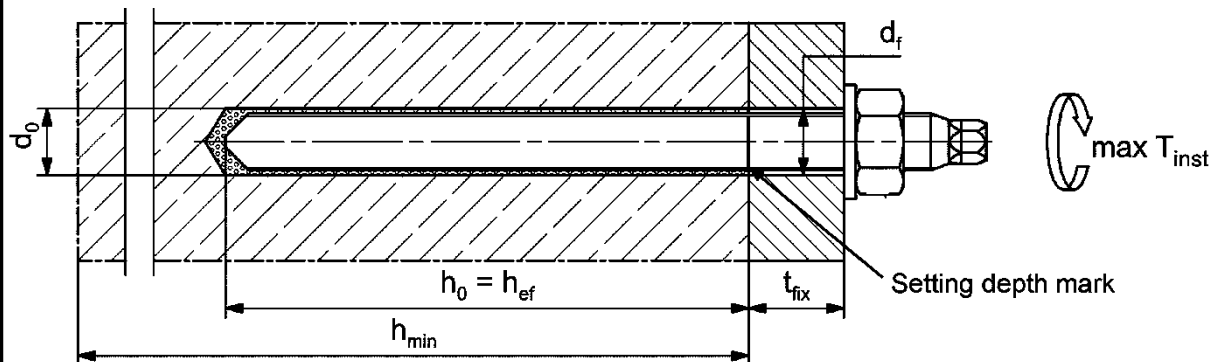

Pictures not to scale

fischer RM II

**Intended Use**  
Installation parameters anchor rods RG M

**Annex B 3**

Appendix 8 / 18

**Table B4.1: Installation parameters for fischer internal threaded anchors RG M I**

Internal threaded anchors RG M I		thread	M8	M10	M12	M16	M20
Diameter of anchor	$d = d_H$	[mm]	12	16	18	22	28
Nominal drill bit diameter	$d_0$		14	18	20	24	32
Drill hole depth	$h_0$		$h_0 = h_{ef} = L_H$				
Effective embedment depth ( $h_{ef} = L_H$ )	$h_{ef}$		90	90	125	160	200
Minimum spacing and minimum edge distance	$s_{min}$ = $c_{min}$		55	65	75	95	125
Diameter of clearance hole in the fixture	$d_f$		9	12	14	18	22
Minimum thickness of concrete member	$h_{min}$		120	125	165	205	260
Maximum screw-in depth	$l_{E,max}$		18	23	26	35	45
Minimum screw-in depth	$l_{E,min}$		8	10	12	16	20
Maximum installation torque	$\max T_{inst}$		[Nm]	10	20	40	80

**fischer internal threaded anchor RG M I**

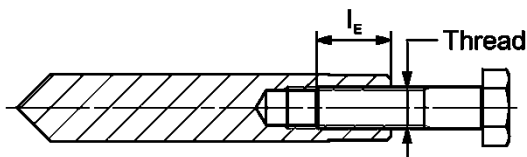
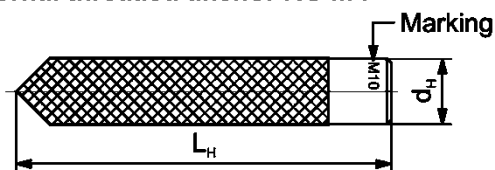

**Marking:** Anchor size e. g.: **M10**  
 Stainless steel → additional **R**; e.g.: **M10 R**  
 High corrosion resistant steel → additional **HCR**; e.g.: **M10 HCR**

Retaining bolt or threaded rods (including nut and washer) must comply with the appropriate material and strength class of Annex A 3, Table A3.1.

**Installation conditions:**

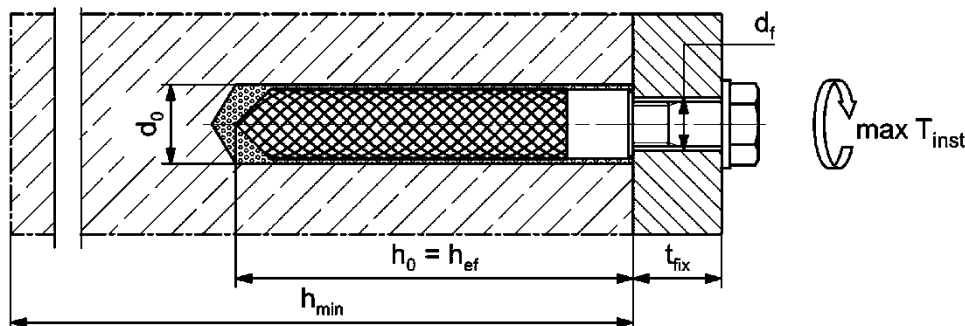

Pictures not to scale

fischer RM II

**Intended Use**  
 Installation parameters fischer internal threaded anchors RG M I

**Annex B 4**

Appendix 9 / 18

**Table B5.1: Dimensions of resin capsule RM II**

Capsule RM II		8	10	12	16	16 E	20/22	24
Capsule diameter	d <sub>P</sub>	9,0	10,5	12,5	16,5		23,0	
	[mm]							
Capsule length	L <sub>P</sub>	85	90	97	95	123	160	190

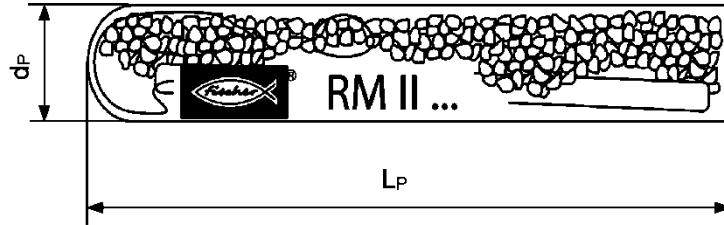
**Table B5.2: Assignment of resin capsule RM II to fischer anchor rod RG M**

Anchor rod RG M			M8	M10	M12	M16	M20	M24
Effective anchorage depth	h <sub>ef</sub>	[mm]	80	90	110	125	170	210
Related capsule RM II		[-]	8	10	12	16	20/22	24

**Table B5.3: Assignment of resin capsule RM II to the fischer internal threaded anchor RG M I**

Internal threaded anchor RG M I			M8	M10	M12	M16	M20
Effective anchorage depth	h <sub>ef</sub>	[mm]	90	90	125	160	200
Related capsule RM II		[-]	10	12	16	16E	24

**Table B5.4: Minimum curing time**

(During the curing time of the mortar the concrete temperature may not fall below the listed minimum temperature; minimal capsule temperature -15 °C)

Temperature in the anchoring base [°C]	Minimum curing time t <sub>ure</sub>
-15 to -10	30 h
> -10 to -5	16 h
> -5 to 0	10 h
> 0 to +5	45 min
> +5 to +10	30 min
> +10 to +20	20 min
> +20 to +30	5 min
> +30 to +40	3 min

fischer RM II

**Intended Use**

Dimensions of the capsules, Assignment of the capsule to the anchor rod and internal threaded anchor, Minimum curing time

**Annex B 5**

Appendix 10 / 18

## Installation instructions part 1

Manual or robotic-assisted, (by fischer BauBot), drilling and cleaning the hole (hammer drilling with standard drill bit)

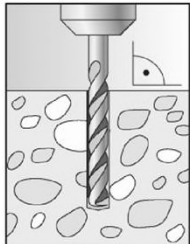
1		<p>Specified drill hole depth <math>h_0</math> should be adhered to (manual e.g. mark on the drill bit, with BauBot by selecting the appropriate drilling program). Drill the hole. Drill hole diameter <math>d_0</math> and drill hole depth <math>h_0</math> see <b>Tables B3.1, B4.1</b>.</p>
---	---	--

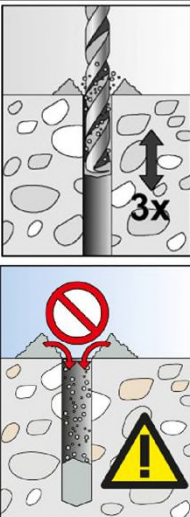
2		<p>When reaching the drill hole depth <math>h_0</math> pull out the drill bit whilst power drill is switched on. To reduce the drill dust in the drill hole repeat this step minimum <b>three times</b>, beginning from the drill hole bottom (discharging the bore hole).</p> <p>Trickling of the bore dust into the drill hole has to be avoided. (e.g. with exhausting the drill dust) Blowing out or brushing the drill hole is not necessary.</p>
---	---	--

Go to step 3

## Manual drilling and cleaning the hole (hammer drilling with hollow drill bit)

1		<p>Check a suitable hollow drill (see <b>Table B1.1</b>) for correct operation of the dust extraction.</p>
---	---	--

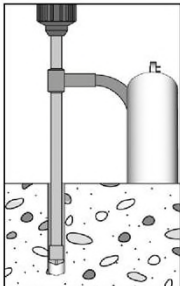
2		<p>Use a suitable dust extraction system, e.g. fischer FVC 35 M or a comparable dust extraction system with equivalent performance data.</p> <p>Drill the hole with hollow drill bit. The dust extraction system has to extract the drill dust nonstop during the drilling process and must be adjusted to maximum power. Diameter of drill hole <math>d_0</math> and drill hole depth <math>h_0</math> see <b>Tables B3.1, B4.1</b>.</p>
---	---	---

Go to step 3

fischer RM II





**Intended use**  
Installation instructions part 1

**Annex B 6**

Appendix 11 / 18

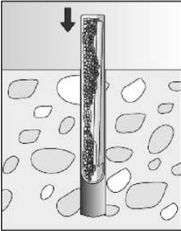
## Installation instructions part 2

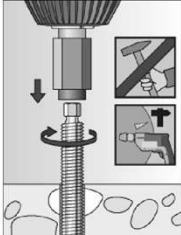
Installation of capsule RM II with fischer anchor rods RG M or fischer internal threaded anchors RG M I

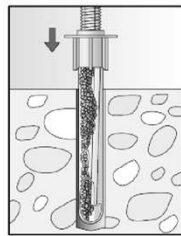
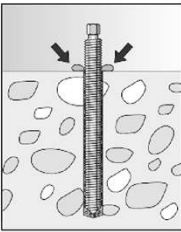
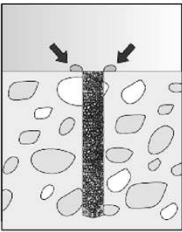
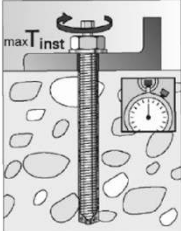
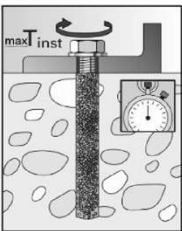
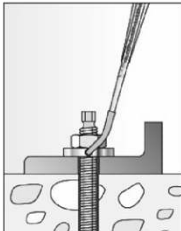
3		<p>Push the capsule RM II into the drill hole.</p>		<p>Depending on the anchor being installed, use a suitable setting tool (e.g. RA-SDS).</p>
4			<p>Only use clean and oil-free metal parts. Using a suitable adapter, drive the RG M or fischer internal threaded anchor RG M I into the capsule using a hammer drill set on rotary hammer action. Stop when the metal part reaches the bottom of the hole and is set to the correct embedment depth.</p>	
Option 3+4		<p>Combined setting method with fischer BauBot, capsule RM II and fischer anchor rod RG M.</p>		
5			<p>When reaching the correct embedment depth, excess mortar must be emerged from the mouth of the drill hole.</p>	
6			<p>Wait for the specified curing time, <math>t_{cure}</math> see <b>Table B5.4</b>.</p>	
Option		<p>After the minimum curing time is reached, the gap between metal part and fixture (annular clearance) may be filled with mortar via the fischer filling disc. compressive strength <math>\geq 50 \text{ N/mm}^2</math> (e.g. fischer injection mortars FIS HB, FIS SB, FIS V Plus, FIS EM Plus).</p>		

fischer RM II

**Intended use**  
Installation instructions part 2

**Annex B 7**

Appendix 12 / 18

**Table C1.1: Characteristic values for steel failure under tension / shear load of fischer anchor rods RG M**

Anchor rod RG M			M8	M10	M12	M16	M20	M24	
<b>Bearing capacity under tension load, steel failure<sup>3)</sup></b>									
Characteristic resistance $N_{Rk,s}$	Steel zinc plated	Property class	4.8	15(13)	23(21)	33	63	98	141
			5.8	19(17)	29(27)	43	79	123	177
			8.8	29(27)	47(43)	68	126	196	282
	Stainless steel R and high corrosion resistant steel HCR		50	19	29	43	79	123	177
			70	26	41	59	110	172	247
			80	30	47	68	126	196	282
<b>Partial factors<sup>1)</sup></b>									
Partial factor $\gamma_{Ms,N}$	Steel zinc plated	Property class	4.8	1,50					
			5.8	1,50					
			8.8	1,50					
	Stainless steel R and high corrosion resistant steel HCR		50	2,86					
			70	1,50 <sup>2)</sup> / 1,87					
			80	1,60					
<b>Bearing capacity under shear load, steel failure<sup>3)</sup></b>									
<b>without lever arm</b>									
Characteristic resistance $V^0_{Rk,s}$	Steel zinc plated	Property class	4.8	9(8)	14(13)	20	38	59	85
			5.8	11(10)	17(16)	25	47	74	106
			8.8	15(13)	23(21)	34	63	98	141
	Stainless steel R and high corrosion resistant steel HCR		50	9	15	21	39	61	89
			70	13	20	30	55	86	124
			80	15	23	34	63	98	141
Ductility factor		$k_7$	[-]						1,0
<b>with lever arm</b>									
Charact. resistance $M^0_{Rk,s}$	Steel zinc plated	Property class	4.8	15(13)	30(27)	52	133	259	448
			5.8	19(16)	37(33)	65	166	324	560
			8.8	30(26)	60(53)	105	266	519	896
	Stainless steel R and high corrosion resistant steel HCR		50	19	37	65	166	324	560
			70	26	52	92	232	454	784
			80	30	60	105	266	519	896
<b>Partial factors<sup>1)</sup></b>									
Partial factor $\gamma_{Ms,V}$	Steel zinc plated	Property class	4.8	1,25					
			5.8	1,25					
			8.8	1,25					
	Stainless steel R and high corrosion resistant steel HCR		50	2,38					
			70	1,25 <sup>2)</sup> / 1,56					
			80	1,33					

<sup>1)</sup> In absence of other national regulations

<sup>2)</sup> Only for fischer RG M made of high corrosion-resistant steel HCR

<sup>3)</sup> Values in brackets are valid for undersized fischer anchor rods RG M with smaller stress area  $A_s$  for hot dip galvanised standard threaded rods according to EN ISO 10684:2004+AC:2009

fischer RM II

**Performances**

Characteristic values for steel failure under tension / shear load of fischer anchor rods RG M

**Annex C 1**

Appendix 13 / 18

**Table C2.1: Characteristic values for steel failure under tension / shear load of fischer internal threaded anchors RG M I**

Internal threaded anchor RG M I				M8	M10	M12	M16	M20	
<b>Bearing capacity under tension load, steel failure</b>									
Characteristic bearing capacity with screw	$N_{Rk,s}$	Property class	5.8	[kN]	19	29	43	79	123
			8.8		29	47	68	108	179
		Property class 70	R		26	41	59	110	172
			HCR		26	41	59	110	172
<b>Partial safety factors<sup>1)</sup></b>									
Partial safety factor	$\gamma_{Ms,N}$	Property class	5.8	[-]	1,50				
			8.8		1,50				
		Property class 70	R		1,87				
			HCR		1,87				
<b>Bearing capacity under shear load, steel failure</b>									
<b>without lever arm</b>									
Characteristic bearing capacity with screw	$V^0_{Rk,s}$	Property class	5.8	[kN]	9,2	14,5	21,1	39,2	62,0
			8.8		14,6	23,2	33,7	54,0	90,0
		Property class 70	R		12,8	20,3	29,5	54,8	86,0
			HCR		12,8	20,3	29,5	54,8	86,0
Ductility factor		$k_7$	[-]	1,0					
<b>with lever arm</b>									
Characteristic bending moment with screw	$M^0_{Rk,s}$	Property class	5.8	[Nm]	20	39	68	173	337
			8.8		30	60	105	266	519
		Property class 70	R		26	52	92	232	454
			HCR		26	52	92	232	454
<b>Partial safety factors<sup>1)</sup></b>									
Partial safety factor	$\gamma_{Ms,V}$	Property class	5.8	[-]	1,25				
			8.8		1,25				
		Property class 70	R		1,56				
			HCR		1,56				

<sup>1)</sup> In absence of other national regulations

fischer RM II

**Performances**

Characteristic values for steel failure under tension / shear load of fischer internal threaded anchor RG M I

**Annex C 2**

Appendix 14 / 18



**Table C3.1: Characteristic values for concrete failure under tension / shear load**

Size		All sizes						
<b>Tension load</b>								
Installation factor	$\gamma_{inst}$	[-]	See annex C 4 to C 5					
<b>Factors for the compressive strength of concrete &gt; C20/25</b>								
Increasing factor for $\tau_{RK}$ $\tau_{RK}(X/Y) = \Psi_c \cdot \tau_{RK}(C20/25)$	C25/30	$\Psi_c$	[-]	1,02				
	C30/37			1,04				
	C35/45			1,07				
	C40/50			1,08				
	C45/55			1,09				
	C50/60			1,10				
<b>Splitting failure</b>								
Edge distance	$h / h_{ef} \geq 2,0$	$C_{cr,sp}$	[mm]	1,0 $h_{ef}$				
	$2,0 > h / h_{ef} > 1,3$			4,6 $h_{ef}$ - 1,8 h				
	$h / h_{ef} \leq 1,3$			2,26 $h_{ef}$				
Spacing	$S_{cr,sp}$			2 $C_{cr,sp}$				
<b>Concrete cone failure</b>								
Uncracked concrete	$k_{ucr,N}$	[-]	11,0					
Cracked concrete	$k_{cr,N}$		7,7					
Edge distance	$C_{cr,N}$	[mm]	1,5 $h_{ef}$					
Spacing	$S_{cr,N}$		2 $C_{cr,N}$					
<b>Factors for sustained tension load</b>								
Factor	$\Psi_{sus}^0$	[-]	-1)					
<b>Shear load</b>								
All installation conditions	$\gamma_{inst}$	[-]	1,0					
<b>Concrete pry-out failure</b>								
Factor for pry-out failure	$k_8$	[-]	2,0					
<b>Concrete edge failure</b>								
Effective length of fastener in shear loading	$l_f$	[mm]	for $d_{nom} \leq 24$ mm: min ( $h_{ef}$ , 12 $d_{nom}$ )					
<b>Calculation diameters</b>								
Size			M8	M10	M12	M16	M20	M24
fischer anchor rods	d	[mm]	8	10	12	16	20	24
fischer internal threaded anchors RG M I	$d_{nom}$		12	16	18	22	28	-2)
<sup>1)</sup> No performance assessed <sup>2)</sup> Anchor type not part of the assessment								
fischer RM II							<b>Annex C 3</b> Appendix 15 / 18	
<b>Performances</b> Characteristic values for concrete failure under tensile / shear load								

**Table C4.1: Characteristic values for combined pull-out and concrete failure for fischer anchor rods RG M in hammer drilled holes; uncracked or cracked concrete**

Anchor rod RG M			M8	M10	M12	M16	M20	M24	
<b>Combined pullout and concrete cone failure</b>									
Calculation diameter	d	[mm]	8	10	12	16	20	24	
<b>Uncracked concrete</b>									
<b>Characteristic bond resistance in uncracked concrete C20/25</b>									
<u>Hammer-drilling with standard drill bit or hollow drill bit (dry and wet concrete)</u>									
Tem- perature range	I: 24 °C / 40 °C	$\tau_{RK,ucr}$	[N/mm <sup>2</sup> ]	12,5	12,5	12,5	12,5	12,5	12,5
	II: 50 °C / 80 °C			12,0	12,0	12,0	12,0	12,0	12,0
	III: 72 °C / 120 °C			10,5	10,5	10,5	10,5	10,5	10,5
<u>Hammer-drilling with standard drill bit or hollow drill bit (flooded hole)</u>									
Tem- perature range	I: 24 °C / 40 °C	$\tau_{RK,ucr}$	[N/mm <sup>2</sup> ]	- <sup>1)</sup>	- <sup>1)</sup>	12,5	12,5	12,5	12,5
	II: 50 °C / 80 °C			- <sup>1)</sup>	- <sup>1)</sup>	12,0	12,0	12,0	12,0
	III: 72 °C / 120 °C			- <sup>1)</sup>	- <sup>1)</sup>	10,5	10,5	10,5	10,5
<b>Installation factors</b>									
Dry and wet concrete	$\gamma_{inst}$	[-]	1,2						
Flooded hole			- <sup>1)</sup>	- <sup>1)</sup>	1,4				
<b>Cracked concrete</b>									
<b>Characteristic bond resistance in cracked concrete C20/25</b>									
<u>Hammer-drilling with standard drill bit or hollow drill bit (dry and wet concrete)</u>									
Tem- perature range	I: 24 °C / 40 °C	$\tau_{RK,cr}$	[N/mm <sup>2</sup> ]	- <sup>1)</sup>	4,5	4,5	4,5	4,5	4,5
	II: 50 °C / 80 °C			- <sup>1)</sup>	4,0	4,0	4,0	4,0	4,0
	III: 72 °C / 120 °C			- <sup>1)</sup>	3,5	3,5	3,5	3,5	3,5
<u>Hammer-drilling with standard drill bit or hollow drill bit (flooded hole)</u>									
Tem- perature range	I: 24 °C / 40 °C	$\tau_{RK,cr}$	[N/mm <sup>2</sup> ]	- <sup>1)</sup>	- <sup>1)</sup>	4,5	4,5	4,5	4,5
	II: 50 °C / 80 °C			- <sup>1)</sup>	- <sup>1)</sup>	4,0	4,0	4,0	4,0
	III: 72 °C / 120 °C			- <sup>1)</sup>	- <sup>1)</sup>	3,5	3,5	3,5	3,5
<b>Installation factors</b>									
Dry and wet concrete	$\gamma_{inst}$	[-]	- <sup>1)</sup>	1,2					
Flooded hole			- <sup>1)</sup>	- <sup>1)</sup>	1,4				

<sup>1)</sup> No performance assessed

fischer RM II

**Performances**

Characteristic values for combined pull-out and concrete failure for fischer anchor rod RG M

**Annex C 4**

Appendix 16 / 18

**Table C5.1: Characteristic values for combined pull-out and concrete failure for fischer internal threaded anchors RG M I in hammer drilled holes; uncracked or cracked concrete**

Internal threaded anchors RG M I			M8	M10	M12	M16	M20	
<b>Combined pullout and concrete cone failure</b>								
Calculation diameter	d	[mm]	12	16	18	22	28	
<b>Uncracked concrete</b>								
<b>Characteristic bond resistance in uncracked concrete C20/25</b>								
Hammer-drilling with standard drill bit or hollow drill bit (dry and wet concrete)								
Temperature range	I: 24 °C / 40 °C	$\tau_{RK,ucr}$	[N/mm <sup>2</sup> ]	11	11	11	11	11
	II: 50 °C / 80 °C			10,5	10,5	10,5	10,5	10,5
	III: 72 °C / 120 °C			9,5	9,5	9,5	9,5	9,5
Hammer-drilling with standard drill bit or hollow drill bit (flooded hole)								
Temperature range	I: 24 °C / 40 °C	$\tau_{RK,ucr}$	[N/mm <sup>2</sup> ]	11	11	- <sup>1)</sup>	11	- <sup>1)</sup>
	II: 50 °C / 80 °C			10,5	10,5	- <sup>1)</sup>	10,5	- <sup>1)</sup>
	III: 72 °C / 120 °C			9,5	9,5	- <sup>1)</sup>	9,5	- <sup>1)</sup>
<b>Installation factors</b>								
Dry and wet concrete	$\gamma_{inst}$	[-]	1,2					
Flooded hole			1,4	- <sup>1)</sup>	1,4	- <sup>1)</sup>		
<b>Cracked concrete</b>								
<b>Characteristic bond resistance in cracked concrete C20/25</b>								
Hammer-drilling with standard drill bit or hollow drill bit (dry and wet concrete)								
Temperature range	I: 24 °C / 40 °C	$\tau_{RK,cr}$	[N/mm <sup>2</sup> ]	4,5	4,5	4,5	4,5	4,5
	II: 50 °C / 80 °C			4,0	4,0	4,0	4,0	4,0
	III: 72 °C / 120 °C			3,5	3,5	3,5	3,5	3,5
Hammer-drilling with standard drill bit or hollow drill bit (flooded hole)								
Temperature range	I: 24 °C / 40 °C	$\tau_{RK,cr}$	[N/mm <sup>2</sup> ]	4,5	4,5	- <sup>1)</sup>	4,5	- <sup>1)</sup>
	II: 50 °C / 80 °C			4,0	4,0	- <sup>1)</sup>	4,0	- <sup>1)</sup>
	III: 72 °C / 120 °C			3,5	3,5	- <sup>1)</sup>	3,5	- <sup>1)</sup>
<b>Installation factors</b>								
Dry and wet concrete	$\gamma_{inst}$	[-]	1,2					
Flooded hole			1,4	- <sup>1)</sup>	1,4	- <sup>1)</sup>		

<sup>1)</sup> No performance assessed

fischer RM II

**Performances**

Characteristic values for combined pull-out and concrete failure for fischer internal threaded anchors RG M I

**Annex C 5**

Appendix 17 / 18

**Table C6.1: Displacements for fischer anchor rods RG M**

Anchor rod RG M	M8	M10	M12	M16	M20	M24	
<b>Displacement-Factors for tension load<sup>1)</sup></b>							
<b>Uncracked or cracked concrete; Temperature range I, II, III</b>							
$\delta_{N0}$ -Factor	[mm/(N/mm <sup>2</sup> )]	0,07	0,08	0,09	0,10	0,11	0,12
$\delta_{N\infty}$ -Factor		0,13	0,14	0,15	0,17	0,17	0,18
<b>Displacement-Factors for shear load<sup>2)</sup></b>							
<b>Uncracked or cracked concrete; Temperature range I, II, III</b>							
$\delta_{V0}$ -Factor	[mm/kN]	0,18	0,15	0,12	0,09	0,07	0,06
$\delta_{V\infty}$ -Factor		0,27	0,22	0,18	0,14	0,11	0,09

1) Calculation of effective displacement:

$$\delta_{N0} = \delta_{N0}\text{-Factor} \cdot \tau$$

$$\delta_{N\infty} = \delta_{N\infty}\text{-Factor} \cdot \tau$$

( $\tau$ : acting bond strength under tension load)

2) Calculation of effective displacement:

$$\delta_{V0} = \delta_{V0}\text{-Factor} \cdot V$$

$$\delta_{V\infty} = \delta_{V\infty}\text{-Factor} \cdot V$$

( $V$ : acting shear load)

**Table C6.2: Displacements for fischer internal threaded anchors RG M I**

Internal threaded anchor RG M I	M8	M10	M12	M16	M20	
<b>Displacement-Factors for tension load<sup>1)</sup></b>						
<b>Uncracked or cracked concrete; Temperature range I, II, III</b>						
$\delta_{N0}$ -Factor	[mm/(N/mm <sup>2</sup> )]	0,09	0,10	0,10	0,11	0,19
$\delta_{N\infty}$ -Factor		0,13	0,15	0,15	0,17	0,19
<b>Displacement-Factors for shear load<sup>2)</sup></b>						
<b>Uncracked or cracked concrete; Temperature range I, II, III</b>						
$\delta_{V0}$ -Factor	[mm/kN]	0,12	0,09	0,08	0,07	0,05
$\delta_{V\infty}$ -Factor		0,18	0,14	0,12	0,10	0,08

1) Calculation of effective displacement:

$$\delta_{N0} = \delta_{N0}\text{-Factor} \cdot \tau$$

$$\delta_{N\infty} = \delta_{N\infty}\text{-Factor} \cdot \tau$$

( $\tau$ : acting bond strength under tension load)

2) Calculation of effective displacement:

$$\delta_{V0} = \delta_{V0}\text{-Factor} \cdot V$$

$$\delta_{V\infty} = \delta_{V\infty}\text{-Factor} \cdot V$$

( $V$ : acting shear load)

fischer RM II

**Performances**

Displacements for anchor rods RGM and fischer internal threaded anchors RG M I

**Annex C 6**

Appendix 18 / 18