

## VYHLÁSENIE O PARAMETROCH

### DoP 0396

pre fischer FIS EM Plus dynamic (Dodatočné upevnenie v betóne s trhlinami alebo v betóne bez trhlín)

SK

1. Jedinečný identifikačný kód typu výrobku: **DoP 0396**
2. Zamýšľané použitie/použitia: **Dodatočne montované upevňovacie prvky pre použitie v betóne pri únavovom cyklickom zaťažení, pozri prílohu, najmä prílohy B1 - B9.**
3. Výrobca: **fischerwerke GmbH & Co. KG, Otto-Hahn-Straße 15, 79211 Denzlingen, Nemecko**
4. Splnomocnený zástupca: **-**
5. Systém(-y) posudzovania a overovania nemennosti parametrov: **1**
6. Európsky hodnotiaci dokument: **EAD 330250-01-0601**  
Európske technické posúdenie: **ETA-23/0842; 2025-12-16**  
Orgán technického posudzovania: **DIBt- Deutsches Institut für Bautechnik**  
Notifikovaný(-é) subjekt(-y): **2873 TU Darmstadt**
7. Deklarované parametre:  
**EAD 330250-01-0601; Table 2.1.3**  
**Metóda hodnotenia C: Linearizovaná funkcia**  
**Mechanická odolnosť a stabilita (BWR 1)**
  - 1 Charakteristická odolnosť ocele pri únavovom zaťažení v ťahu: Prílohy C1, C3, C4
  - 2 Charakteristická odolnosť vytrhnutia betónového kužela, vytiahnutia a rozlomenia pri zaťažení v ťahu: Prílohy C1, C3, C4
  - 3 Charakteristická odolnosť voči vytiahnutiu alebo voči kombinácii vytiahnutie / vytrhnutie betónového kužela pri únavovom zaťažení v ťahu: Prílohy C1, C3, C4
  - 4 Charakteristická odolnosť ocele voči únave pri šmykovom zaťažení: Prílohy C2, C3, C4
  - 5 Charakteristická odolnosť okrajov betónu pri únavovom zaťažení v šmyku: Prílohy C2, C3, C4
  - 6 Charakteristická odolnosť betónu voči vylomeniu pri únavovom zaťažení v šmyku: Prílohy C2, C3, C4
  - 7 Charakteristická odolnosť ocele pri únavovom zaťažení v ťahu a šmyku: Prílohy C1 - C4
  - 8 Faktor prenosu zaťaženia pre ťahové a šmykové zaťaženie: Prílohy C1 - C4
8. Vhodná technická dokumentácia a/alebo špecifická technická dokumentácia: **-**

Uvedené parametre výrobku sú v zhode so súborom deklarovanych parametrov. Toto vyhlásenie o parametroch sa v súlade s nariadením (EÚ) č. 305/2011 vydáva na výhradnú zodpovednosť uvedeného výrobcu.

Podpísal(-a) za a v mene výrobcu:



Alexander Zanocco, Generálny riaditeľ pre predaj a Generálny riaditeľ pre výskum a vývoj  
Tumlingen, 2026-04-14



Dieter Pfaff, Vedúci Medzinárodnej produkčnej federácie a riadenia kvality

Toto vyhlásenie o vlastnostiach bolo vyhotovené v rôznych jazykoch. V prípade, že dôjde k rozdielnemu výkladu má anglická verzia vždy prednosť.

Príloha obsahuje dobrovoľné a doplňujúce informácie v anglickom jazyku. Tieto vychádzajú zo zákonom stanovených požiadaviek (jazykovo neutrálnych).

EAD 330250-01-0601; Table 2.1.3; Assessment Method C: Linearized function  
 EAD 330250-01-0601; Table 2.1.3; Metóda hodnotenia C: Linearizovaná funkcia

Mechanical resistance and stability (BWR 1)		
Mechanická odolnosť a stabilita (BWR 1)		
1	Characteristic steel fatigue resistance under tension loading:  <b>Charakteristická odolnosť ocele pri únavovom zaťažení v ťahu:</b>	$\Delta N_{Rk,s,0,n}$ (n=1 to n= $\infty$ )
2	Characteristic concrete cone, pull-out, splitting and blow out fatigue resistance under tension loading: <b>Charakteristická odolnosť vytrhnutia betónového kužela, vytiahnutia a rozlomenia pri zaťažení v ťahu:</b>	$\Delta N_{Rk,c,0,n}; \Delta N_{Rk,sp,0,n}$ (n=1 to n= $\infty$ )
3	Characteristic pull-out or combined pull-out /concrete cone fatigue resistance under tension loading: <b>Charakteristická odolnosť voči vytiahnutiu alebo voči kombinácii vytiahnutie / vytrhnutie betónového kužela pri únavovom zaťažení v ťahu:</b>	$\Delta T_{Rk,p,0,n};$ (n=1 to n= $\infty$ ) $\Delta T_{Rk,p,0,n};$ (n=1 to n= $10^8$ ) $\Delta N_{Rk,p,0,n};$ (n=1 to n= $\infty$ )
4	Characteristic steel fatigue resistance under shear loading:  <b>Charakteristická odolnosť ocele voči únave pri šmykovom zaťažení:</b>	$\Delta V_{Rk,s,0,n}$ (n=1 to n= $\infty$ )
5	Characteristic concrete edge fatigue resistance under shear loading:  <b>Charakteristická odolnosť okrajov betónu pri únavovom zaťažení v šmyku:</b>	$\Delta V_{Rk,c,0,n}$ (n=1 to n= $\infty$ )
6	Characteristic concrete pry-out fatigue resistance under shear loading:  <b>Charakteristická odolnosť betónu voči vylomeniu pri únavovom zaťažení v šmyku:</b>	$\Delta V_{Rk,cp,0,n}$ (n=1 to n= $\infty$ )
7	Characteristic steel fatigue resistance under tension and shear:  <b>Charakteristická odolnosť ocele pri únavovom zaťažení v ťahu a šmyku:</b>	$\alpha_s$
8	Load transfer factor for tension and shear loading:  <b>Faktor prenosu zaťaženia pre ťahové a šmykové zaťaženie:</b>	$\Psi_{FN}, \Psi_{FV}$

## Specific Part

### 1 Technical description of the product

The "fischer injection system FIS EM Plus dynamic" is a bonded fastener consisting of a cartridge with injection mortar fischer FIS EM Plus and a steel element according to Annex A3.

The steel element is placed into a drilled hole filled with injection mortar and is anchored via the bond between metal part, injection mortar and concrete.

The product description is given in Annex A.

### 2 Specification of the intended use in accordance with the applicable European Assessment Document

The performances given in Section 3 are only valid if the anchor is used in compliance with the specifications and conditions given in Annex B.

The verifications and assessment methods on which this European Technical Assessment is based lead to the assumption of a working life of the anchor of at least 50 years. The indications given on the working life cannot be interpreted as a guarantee given by the producer, but are to be regarded only as a means for choosing the right products in relation to the expected economically reasonable working life of the works.

### 3 Performance of the product and references to the methods used for its assessment

#### 3.1 Mechanical resistance and stability (BWR 1)

Essential characteristic (Assessment method C: Linearized function)	Performance
Characteristic fatigue resistance under cyclic tension loading	
Characteristic steel fatigue resistance $\Delta N_{Rk,s,0,n}$ ( $n = 1$ to $n = \infty$ )	See Annex C1, C3 and C4
Characteristic concrete cone and splitting fatigue resistance $\Delta N_{Rk,c,0,n}$ $\Delta N_{Rk,sp,0,n}$ ( $n = 1$ to $n = \infty$ )	
Characteristic combined pull-out /concrete cone fatigue resistance $\Delta \tau_{Rk,p,0,n}$ ( $n = 1$ to $n = \infty$ )	
Characteristic fatigue resistance under cyclic shear loading	
Characteristic steel fatigue resistance $\Delta V_{Rk,s,0,n}$ ( $n = 1$ to $n = \infty$ )	See Annex C2, C3 and C4
Characteristic concrete edge fatigue resistance $\Delta V_{Rk,c,0,n}$ ( $n = 1$ to $n = \infty$ )	
Characteristic concrete pry out fatigue resistance $\Delta V_{Rk,cp,0,n}$ ( $n = 1$ to $n = \infty$ )	

<b>Essential characteristic (Assessment method C: Linearized function)</b>	<b>Performance</b>
Characteristic fatigue resistance under cyclic combined tension and shear loading	
Characteristic steel fatigue resistance $a_s$ ( $n = 1$ to $n = \infty$ )	See Annex C1 to C4
Load transfer factor for cyclic tension and shear loading	
Load transfer factor $\psi_{FN}, \psi_{FV}$	See Annex C1 to C4

**4 Assessment and verification of constancy of performance (AVCP) system applied, with reference to its legal base**

In accordance with European Assessment Document No. 330250-01-0601, the applicable European legal act is: [96/582/EC].

The system to be applied is: 1

**5 Technical details necessary for the implementation of the AVCP system, as provided for in the applicable European Assessment Document**

Technical details necessary for the implementation of the AVCP system are laid down in the control plan deposited with Deutsches Institut für Bautechnik.

## Installation conditions

fischer anchor rod FIS A or RG M with fischer injection system FIS EM Plus

**Pre-positioned installation with dynamic set** (annular gap filled with mortar)

Size: M12, M16, M20, M24

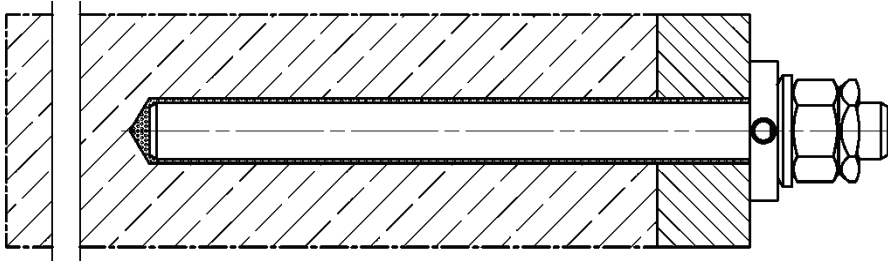

**Push through installation with dynamic set** (annular gap filled with mortar)

Size: M12, M16, M20, M24

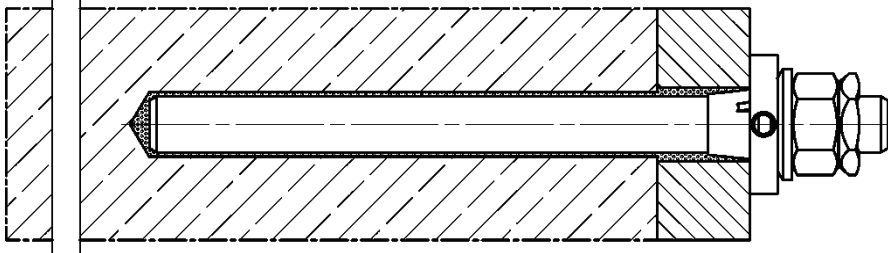

**Push through installation with washer and centering sleeve** (annular gap filled with mortar)

Size: M12, M16, M20, M24

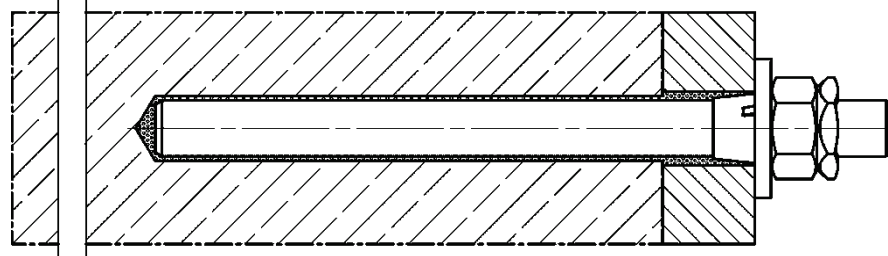

Figures not to scale

**fischer FIS EM Plus dynamic**

**Product description**  
Installed condition

**Annex A1**

Appendix 3 / 19

# Overview system components Part 1

Injection cartridge (shuttle cartridge) FIS EM Plus with sealing cap

Sizes: 390 ml, 585 ml, 1500 ml (the 390 ml hard cartridge is shown as an example)

Size foil bag: 500 ml

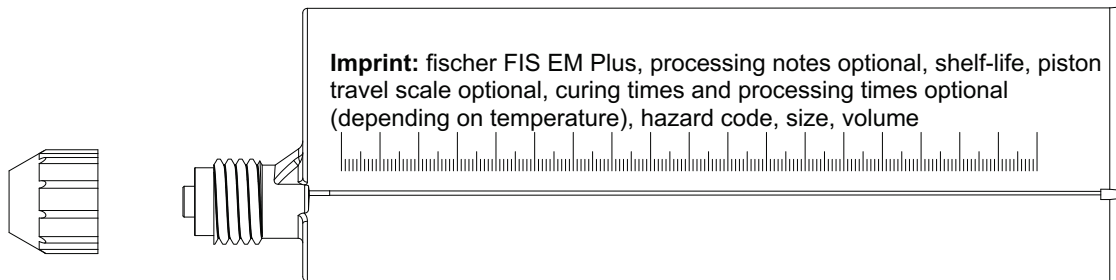

Injection cartridge (coaxial cartridge) FIS EM Plus with sealing cap

Sizes: 300 ml

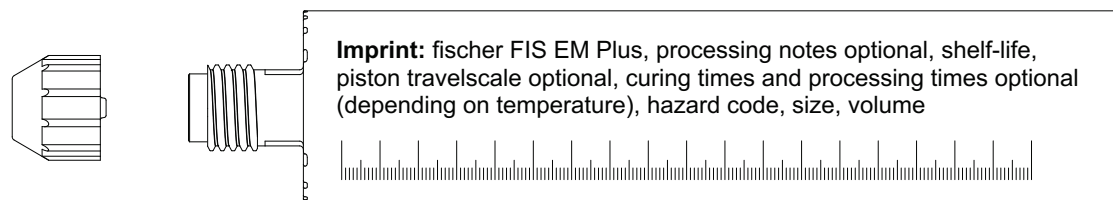

Static mixer FIS MR Plus for injection cartridges  $\leq 500$  ml

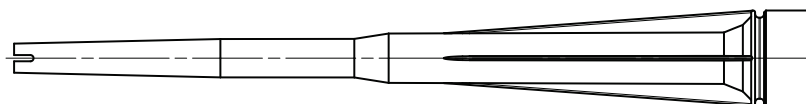

Static mixer FIS UMR for injection cartridges  $\geq 500$  ml

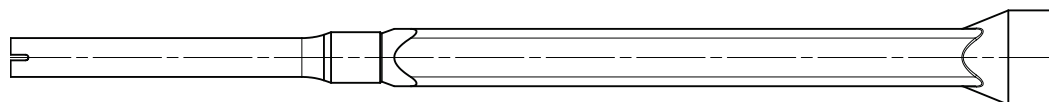

Injection adapter and extension tube  $\varnothing 9$  for static mixer FIS MR Plus;  
Injection adapter and extension tube  $\varnothing 9$  or  $\varnothing 15$  for static mixer FIS UMR

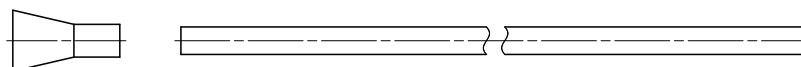

Figures not to scale

**fischer FIS EM Plus dynamic**

## System description

Overview system components part 1;  
cartridges / static mixer / injection adapter

**Annex A2**

Appendix 4 / 19

# Overview system components Part 2

## fischer anchor rod FIS A

Size: M12, M16, M20, M24

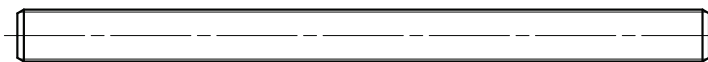

## fischer anchor rod RG M

Size: M12, M16, M20, M24

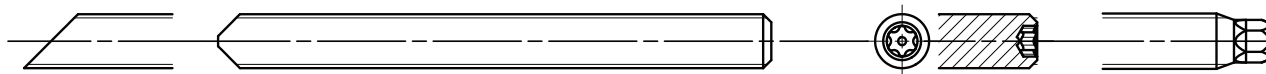

### spherical washer

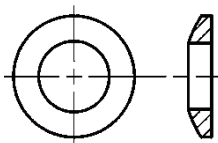

### conical washer (various versions; partly fillable)

without drill hole

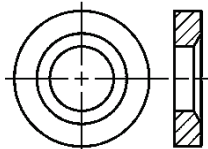

radial

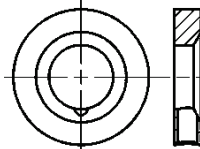

angular

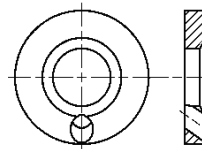

axial

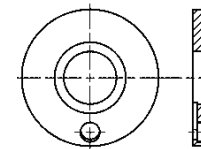

### centering sleeve (only push through installation)

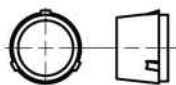

### washer

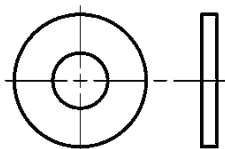

### hexagonal nut with spherical contact surface

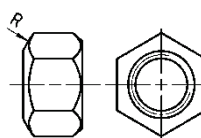

### hexagon nut

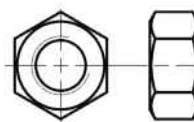

### lock nut

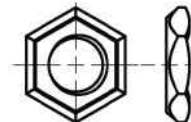

## Injection adapter

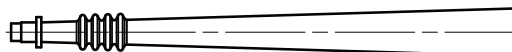

## Cleaning brush BS



## Compressed-air cleaning tool ABP



Figures not to scale

## fischer FIS EM Plus dynamic

### System description

Overview system components part 2;  
Steel components / injection adapter / cleaning brush / Compressed-air cleaning tool

## Annex A3

Appendix 5 / 19

**Table A4.1: Materials**

Part	Designation	Material	
1	Injection cartridge	Mortar, hardener, filler	
	Steel grade	Steel	Stainless steel R
		zinc plated	acc. to EN 10088-1:2023 Corrosion resistance class CRC III acc. to EN 1993-1-4:2006+A1:2015
2	fischer anchor rod FIS A or RG M	Property class 8.8; EN ISO 898-1:2013 zinc plated $\geq 5 \mu\text{m}$ EN ISO 4042:2022 $f_{uk} \leq 1000 \text{ N/mm}^2$	Property class 70 EN ISO 3506-1:2020 1.4401 (M12 to M24) 1.4062 (M12 and M16) 1.4362 (M12 and M16) EN 10088-1:2023 $f_{uk} \leq 1000 \text{ N/mm}^2$
3	Centering sleeve	Plastic	
4a	Washer ISO 7089:2000	---	1.4401; 1.4404; 1.4578; 1.4571; 1.4439; 1.4362; EN 10088-1:2023
4b	Fillable conical washer similar to DIN 6319-G	zinc plated $\geq 5 \mu\text{m}$ , EN ISO 4042: 2022	1.4401; 1.4404; 1.4578; 1.4571; 1.4439; 1.4362; EN 10088-1:2023
5	Spherical washer	zinc plated $\geq 5 \mu\text{m}$ , EN ISO 4042: 2022	1.4401; 1.4404; 1.4578; 1.4571; 1.4439; 1.4362; EN 10088-1:2023
6a	Hexagon nut	Property class 8; EN ISO 898-2:2022 zinc plated $\geq 5 \mu\text{m}$ , EN ISO 4042: 2022	Property class 80 EN ISO 3506-1:2020 1.4401; 1.4404; 1.4578; 1.4571; 1.4439; 1.4362; EN 10088-1:2023
6b	Hexagonal nut with spherical contact surface		
7	Lock nut	zinc plated $\geq 5 \mu\text{m}$ , EN ISO 4042: 2022	1.4401; 1.4404; 1.4578; 1.4571; 1.4439; 1.4362; EN 10088-1:2023





fischer FIS EM Plus dynamic

Product description  
Materials**Annex A4**

Appendix 6 / 19

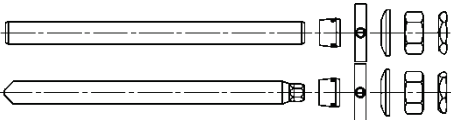
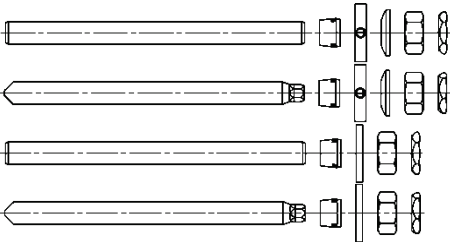
# Specifications of intended use part 1

**Table B1.1:** Overview use and performance categories injection mortar system

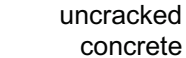
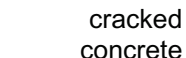
		<b>FIS EM Plus with</b>	
		fischer anchor rod FIS A or fischer anchor rod RG M	
		Steel, zinc plated M12 + M16	Stainless steel R M12 - M24
			
Hammer drilling with standard drill bit 		Nominal drill bit diameter ( $d_0$ ) 14 mm to 18 mm	Nominal drill bit diameter ( $d_0$ ) 14 mm to 28 mm
Hammer drilling with hollow drill bit  (fischer "FHD", Heller "Duster Expert"; Bosch "Speed Clean"; Hilti "TE-CD, TE-YD"; DreBo „D-Plus“; DreBo „D-Max“)			
Diamond drilling 		no performance assessed	
Fatigue load, in  		Steel, zinc plated: M12 and M16	Stainless steel R: M12, M16, M20 and M24
Design method I acc. to EOTA TR 061:2023		n = 1 to n = ∞	
Design method II acc. to EOTA TR 061:2023		n = ∞	
Use category I1 dry or wet concrete		M12, M16, M20 and M24	
Installation direction		D3 Downwards, horizontal and upwards (overhead) installation	
Installation method		pre-positioned or push through installation	
Installation temperature		FIS EM Plus: $T_{i,min} = -5\text{ °C}$ to $T_{i,max} = +40\text{ °C}$	
In-service temperature	Temperature range I:	-40 °C to +40 °C	(max. short term temperature +40 °C; max. long term temperature +24 °C)
	Temperature range II:	-40 °C to +60 °C	(max. short term temperature +60 °C; max. long term temperature +35 °C)
	Temperature range III:	-40 °C to +72 °C	(max. short term temperature +72 °C; max. long term temperature +50 °C)

**fischer FIS EM Plus dynamic**

**Intended use**  
Specifications part 1

**Annex B1**

Appendix 7 / 19

## Specifications of intended use part 2

### Base materials:

- Compacted reinforced or unreinforced normal weight concrete without fibers of strength classes C20/25 to C50/60 according to EN 206:2013+A2:2021.

### Use conditions (Environmental conditions):

- Structures subject to dry internal conditions (zinc plated steel, stainless steel R).
- For all other conditions according to EN 1993-1-4:2006+A1:2015 corresponding to corrosion resistance classes to Annex A4 Table A4.1.

### Design:

- Fastenings have to be designed by a responsible engineer with experience of concrete anchor design.
- Verifiable calculation notes and drawings are to be prepared taking account of the loads to be anchored. The position of the anchor is indicated on the design drawings (e. g. position of the anchor relative to reinforcement or to supports, etc.).
- Anchorages have to be designed in accordance with:
  - EN 1992-4:2018 and
  - EOTA Technical Report TR 061 "Design method for fasteners in concrete under fatigue cyclic loading", Edition 2023.
- Static and quasi-static loading see ETA-17/0979 of 16.12.2025.
- Fastenings shall be positioned outside of critical regions (e.g. plastic hinges) of the concrete structure.
- Fastenings in stand-off installation or with a grout layer are not covered by this European Technical Assessment (ETA).

### Installation:

- Anchor installation is to be carried out by appropriately qualified personnel and under the supervision of the person responsible for technical matters of the site.
- In case of aborted hole: The hole shall be filled with mortar.
- Fastening depth should be marked and adhered to on installation.
- If only tension loads are involved in the application, the annular gap does not need to be filled.
- Overhead installation is allowed.
- Setting the fastener with clearance between concrete and anchor plate (only if the fastener is loaded in axial direction)

**fischer FIS EM Plus dynamic**

**Intended use**  
Specifications part 2

**Annex B2**

Appendix 8 / 19

**Table B3.1:** Installation parameters for fischer anchor rods in combination with injection mortar system FIS EM Plus

fischer anchor rods		Thread	M12	M16	M20	M24
Material			zinc plated steel or stainless steel R		stainless steel R	
Nominal drill hole diameter	$d_0$	[mm]	14	18	24	28
Drill hole depth	$h_0$		$h_0 = h_{ef}$			
Effective embedment depth Design method I	$h_{ef, min}$ $h_{ef, max}$		70 240	80 320	90 400	96 480
Effective embedment depth Design method II	$h_{ef, min}$ $h_{ef, max}$		95 240	125 320	160 400	190 480
Minimum spacing and minimum edge distance	$s_{min}$ = $c_{min}$		55	65	85	105
Diameter of the clearance hole of the fixture	pre-positioned installation $d_f$		14-16	18-20	22-26	26-30
	push through installation $d_f$		15-16	19-20	25-26	29-30
Fixture thickness	$t_{fix, min}$		6	8	10	12
	$t_{fix, max}$		200			
Minimum thickness of concrete member	$h_{min}$		$h_{ef} + 30$	$h_{ef} + 2d_0$	$h_{ef} + 2d_0$	$h_{ef} + 2d_0$
<b>Installation with dynamic set</b>						
Protrusion anchor rod FIS A or RG M without hexagon head	$h_{p, min}$	[mm]	$25 + t_{fix}$	$30 + t_{fix}$	$36 + t_{fix}$	$43 + t_{fix}$
Protrusion anchor rod RG M (with hexagon head)	$h_{p, min}$		$32 + t_{fix}$	$38 + t_{fix}$	$43 + t_{fix}$	---
<b>Installation with washer (only with stainless steel R)</b>						
Protrusion anchor rod FIS A or RG M without hexagon head	$h_{p2, min}$	[mm]	$19 + t_{fix}$	$23 + t_{fix}$	$27 + t_{fix}$	$32 + t_{fix}$
Protrusion anchor rod RG M (with hexagon head)	$h_{p2, min}$		$26 + t_{fix}$	$31 + t_{fix}$	$34 + t_{fix}$	---
Required installation torque	$T_{inst}$	[Nm]	40	60	120	150

**fischer anchor rod FIS A or RG M**

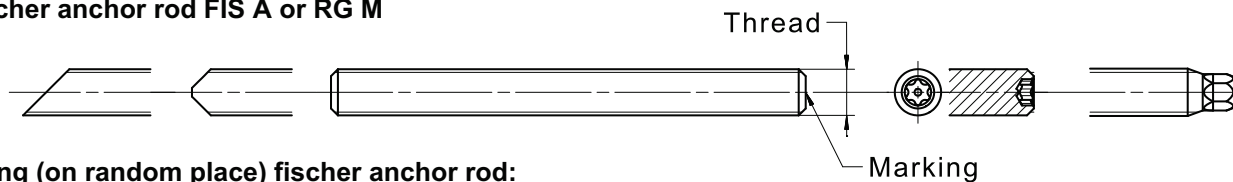

**Marking (on random place) fischer anchor rod:**

Property class 8.8: +

**Installation conditions see Annex B4**

Figures not to scale

**fischer FIS EM Plus dynamic**

**Intended use**

Installation parameters fischer anchor rods FIS A and RG M in combination with injection mortar system FIS EM Plus

**Annex B3**

Appendix 9 / 19

**Installation conditions FIS A or RG M with dynamic set or washer with centering sleeve**

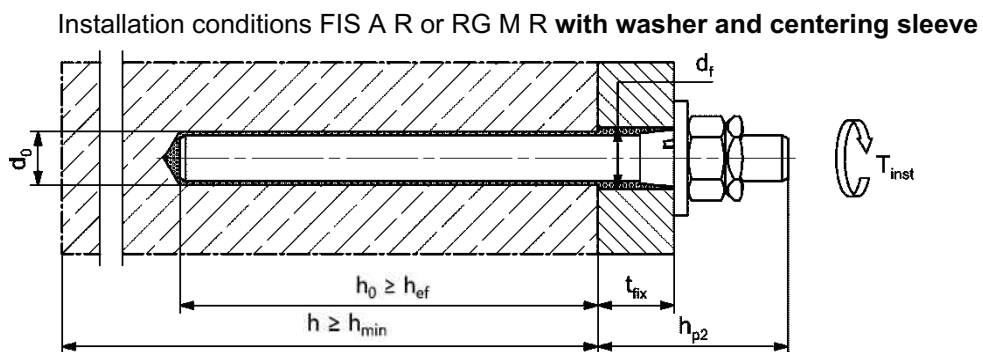
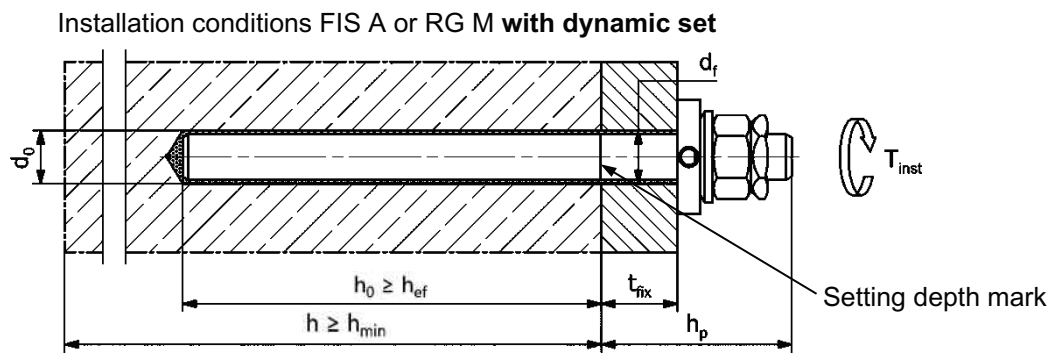

Figures not to scale

**fischer FIS EM Plus dynamic**

**Intended use**

Installation conditions FIS A or RG M with dynamic set or washer with centering sleeve

**Annex B4**

Appendix 10 / 19

**Table B5.1:** Parameters of the cleaning brush BS (steel brush with steel bristles)  
The size of the cleaning brush refers to the drill hole diameter

Nominal drill hole diameter	$d_0$	[mm]	14	18	24	28
Steel brush diameter	$d_b$		16	20	26	30

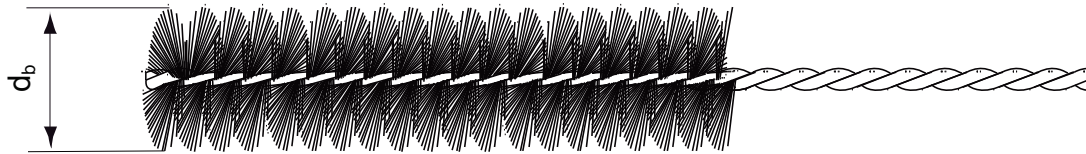

**Table B5.2:** Conditions for use **static mixer** without an **extension tube**

Nominal drill hole diameter	$d_0$	[mm]	14	18	24	28
Drill hole depth $h_0$ by using	FIS MR Plus	[mm]	$\leq 120$	$\leq 150$	$\leq 190$	$\leq 210$
	FIS UMR	[mm]	$\leq 90$	$\leq 180$	$\leq 220$	$\leq 250$

**Table B5.3:** **Maximum processing time** of the mortar and **minimum curing time**

During the curing time of the mortar the concrete temperature may not fall below the listed minimum temperature.

Temperature at anchoring base [°C]	Maximum processing time $t_{work}$	Minimum curing time <sup>1)</sup> $t_{cure}$
> -5 to $\pm 0$ <sup>2)</sup>	240 min	200 h
> $\pm 0$ to +5 <sup>2)</sup>	150 min	90 h
> +5 to +10	120 min	40 h
> +10 to +20	30 min	18 h
> +20 to +30	14 min	10 h
> +30 to +40	7 min	5 h

<sup>1)</sup> In wet concrete the curing times must be doubled

<sup>2)</sup> Minimal cartridge temperature +5°C

**fischer FIS EM Plus dynamic**

**Intended use**





Cleaning brush (steel brush)  
Processing time and curing time

**Annex B5**

Appendix 11 / 19

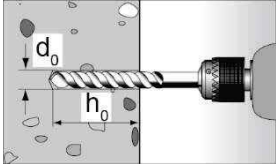
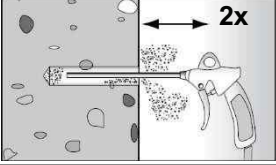
# Installation instructions part 1; injection mortar system FIS EM Plus

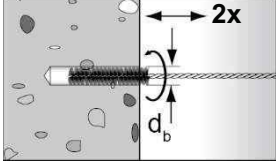
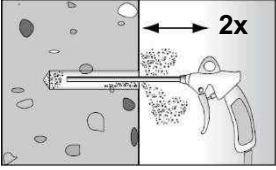
## Drilling and cleaning the hole (hammer drilling with standard drill bit)

1		<p>Drill the hole. Nominal drill hole diameter <math>d_0</math> and drill hole depth <math>h_0</math> see <b>Table B3.1</b>.</p>
2		<p>Cleaning the drill hole: Blow out the drill hole twice, with oil free compressed air (<math>p \geq 6</math> bar).</p> 
3		<p>Brush the drill hole twice. For drill hole diameter <math>\geq 30</math> mm use a power drill. For deep holes use an extension. Corresponding brushes see <b>Table B5.1</b>.</p>
4		<p>Cleaning the drill hole: Blow out the drill hole twice, with oil free compressed air (<math>p \geq 6</math> bar).</p> 

Go to step 5 **Annex B7**

## Drilling and cleaning the hole (hammer drilling with hollow drill bit)

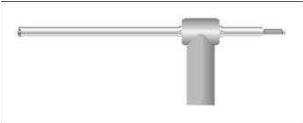
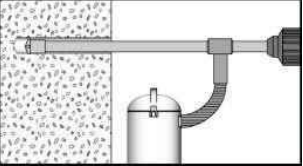
1		<p>Check a suitable hollow drill (see <b>Table B1.1</b>) for correct operation of the dust extraction.</p>
2		<p>Use a suitable dust extraction system, e. g. fischer FVC 35 M or a comparable dust extraction system with equivalent performance data.</p> <p>Drill the hole with hollow drill bit. The dust extraction system has to extract the drill dust nonstop during the drilling process and must be adjusted to maximum power. Nominal drill hole diameter <math>d_0</math> and drill hole depth <math>h_0</math> see <b>Table B3.1</b>.</p>

Go to step 5 **Annex B7**.

**fischer FIS EM Plus dynamic**

### Intended use

Installation instructions part 1; injection mortar system FIS EM Plus

**Annex B6**

Appendix 12 / 19

## Installation instructions part 2; injection mortar system FIS EM Plus

### Preparing the cartridge

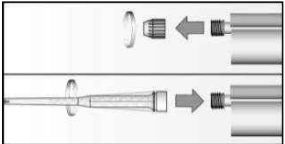
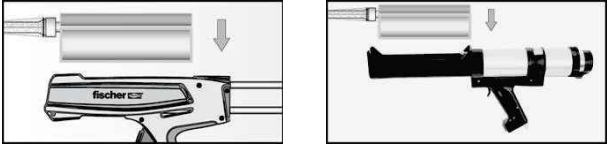
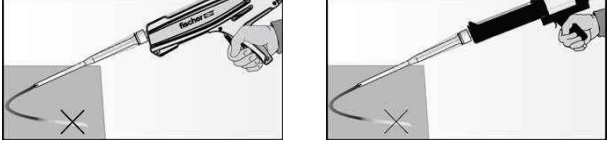
5		<p>Remove the sealing cap. Screw on the static mixer (the spiral in the static mixer must be clearly visible).</p>
6		<p>Place the cartridge into the dispenser.  When using the foilbag, the foil container holder must be used.</p>
7		<p>Extrude approximately 10 cm of material out until the resin is evenly grey in colour. Do not use mortar that is not uniformly grey.</p>

Go to step 8 (Pre-positioned installation **Annex B8** or push through installation **Annex B9**).

**fischer FIS EM Plus dynamic**

#### Intended use

Installation instructions part 2; injection mortar system FIS EM Plus

**Annex B7**

Appendix 13 / 19

# Installation instructions part 3, injection mortar system FIS EM Plus

## Pre-positioned installation

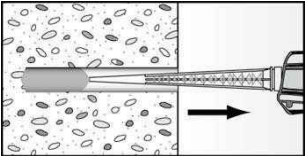
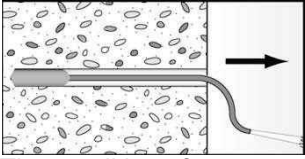
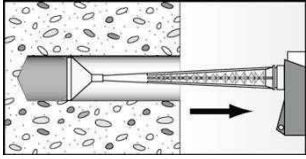
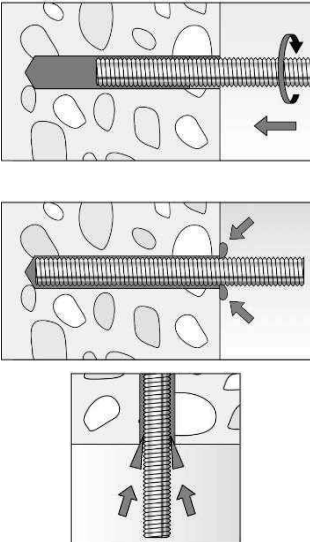
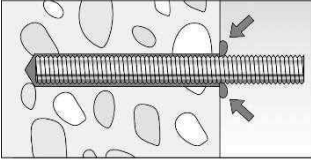
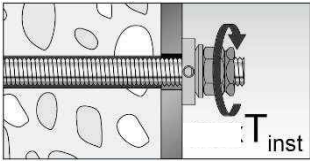
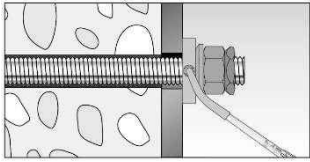
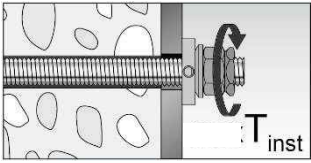
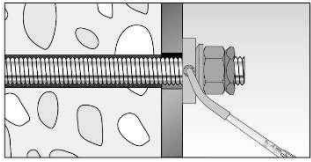
<p>8</p>	 <p>Fill approximately 2/3 of the drill hole with mortar. Always begin from the bottom of the hole and avoid bubbles.</p>	 <p>The conditions for mortar injection without extension tube can be found in <b>Table B5.2</b> For deeper drill holes, than those mentioned in <b>Table B5.2</b>, use a suitable extension tube.</p>	 <p>For overhead installation or deep holes (<math>h_0 &gt; 250\text{mm}</math>) use an injection-adapter.</p>
<p>9</p>	   <p>Only use clean and oil-free metal parts. Mark the setting depth of the anchor rod. Push the fischer anchor rod down to the bottom of the hole, turning it slightly while doing so.</p> <p>After inserting the anchor rod, excess mortar must be emerged around the anchor element. If not, pull out the anchor element immediately and reinject mortar.</p> <p>For overhead installations support the anchor rod with wedges (e.g. fischer centering wedges) until the mortar begins to harden.</p>		
<p>10</p>		<p>Wait for the specified curing time <math>t_{\text{cure}}</math> see <b>Table B5.3</b>.</p>	
<p>11</p>		<p>Attach the component and install the washer and nuts - without centering sleeve. Tighten the hexagon nut with torque wrench, <math>T_{\text{inst}}</math> see <b>Table B3.1</b>. Tighten lock nut manually, then use wrench to give another quarter or half turn.</p>	
<p>12</p>		<p>The gap between anchor and fixture (annular clearance) has to be filled with mortar (FIS HB, FIS SB, FIS V Plus or FIS EM Plus) via the fillable conical washer. If only tension loads are involved in the application, the annular gap does not necessarily have to be filled.</p>	

fischer FIS EM Plus dynamic

**Intended use**

Installation instructions part 3; pre-positioned installation; injection mortar system FIS EM Plus

**Annex B8**

Appendix 14 / 19

# Installation instructions part 4, injection mortar system FIS EM Plus

## Push through installation

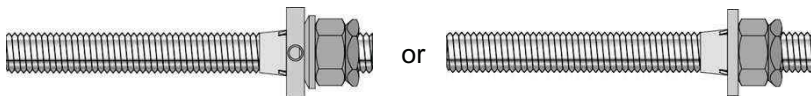
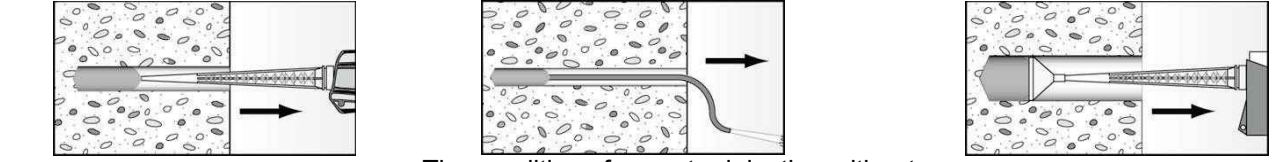
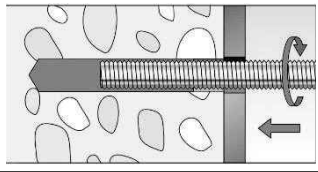
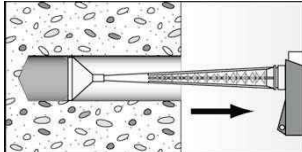
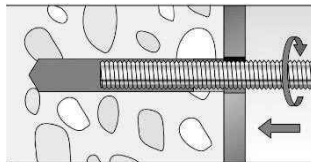
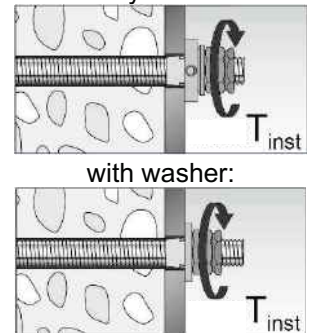
8		<p><b>Pre-assemble the anchor!</b> (Position of the conical washer or washer = embedment depth + fixture thickness)</p>
9	 <p>Fill approximately 2/3 of the drill hole with mortar. Always begin from the bottom of the hole and avoid bubbles.</p> <p>The conditions for mortar injection without extension tube can be found in <b>Table B5.2</b>. For deeper drill holes, than those mentioned in <b>Table B5.2</b>, use a suitable extension tube.</p> <p>For overhead installation or deep holes (<math>h_0 &gt; 250\text{mm}</math>) use an injection-adapter.</p>	
	 <p>Only use clean and oil-free metal parts. Push the pre-assembled Fischer anchor rod into the drill hole until the conical washer or washer is in full contact with the surface, turning it slightly while doing so.</p>	
10	 <p>with dynamic set:</p> <p>with washer:</p> <p>After inserting the anchor rod with pre-assembled components, excess mortar must be emerged around the anchor element (minimum on one point of the conical washer or washer). If not, pull out the anchor element immediately and reinject mortar.</p>	
11	 <p>Wait for the specified curing time <math>t_{\text{cure}}</math> see <b>Table B5.3</b>.</p>	
12	 <p>with dynamic set:</p> <p>with washer:</p> <p>Tighten the hexagon nut with torque wrench, <math>T_{\text{inst}}</math> see <b>Table B3.1</b>. Tighten lock nut manually, then use wrench to give another quarter or half turn.</p>	

fischer FIS EM Plus dynamic

### Intended use

Installation instructions part 4; push through installation; injection mortar system FIS EM Plus

**Annex B9**

Appendix 15 / 19

**Table C1.1:** Essential characteristics under tension fatigue loading for FIS EM Plus;  
Design method I according to TR 061

Required evidence				
Number of load cycles (n)				
$n \leq 10^4$	$10^4 < n \leq 5 \cdot 10^6$	$5 \cdot 10^6 < n \leq 10^8$	$n > 10^8$	
Tension loading				
Characteristic steel fatigue resistance (zinc plated steel 8.8)				
$\Delta N_{Rk,s,0,n}$ (8.8) [kN]				
$0,75 \cdot N_{Rk,s,(8.8)} \cdot 0,33$	$0,75 \cdot N_{Rk,s,(8.8)} \cdot 10^{(-0,12 \cdot \log(n))} \leq 0,75 \cdot N_{Rk,s,(8.8)} \cdot 0,33$	$0,75 \cdot N_{Rk,s,(8.8)} \cdot 10^{(-0,438 - 0,057 \cdot \log(n))}$	$0,75 \cdot N_{Rk,s,(8.8)} \cdot 0,12$	
Characteristic steel fatigue resistance (stainless steel R, property class 70)				
$\Delta N_{Rk,s,0,n}$ (R-70) [kN]				
$0,75 \cdot N_{Rk,s,(R-70)} \cdot 0,33$	$0,75 \cdot N_{Rk,s,(R-70)} \cdot 10^{(-0,16 - 0,09 \cdot \log(n))}$	$0,75 \cdot N_{Rk,s,(R-70)} \cdot 10^{(-0,469 - 0,043 \cdot \log(n))}$	$0,75 \cdot N_{Rk,s,(R-70)} \cdot 0,15$	
Characteristic combined pull-out / concrete cone fatigue resistance, in uncracked and cracked concrete				
Characteristic bond strength in uncracked concrete				
$\Delta \tau_{Rk,p,ucr,0,n}$ [N/mm <sup>2</sup> ]				
$\tau_{Rk,ucr} \cdot 0,575$	$\tau_{Rk,ucr} \cdot 10^{(-0,06 \cdot \log(n))}$	$\tau_{Rk,ucr} \cdot 10^{(-0,207 - 0,029 \cdot \log(n))}$	$\tau_{Rk,ucr} \cdot 0,35$	
Characteristic bond strength in cracked concrete				
$\Delta \tau_{Rk,p,cr,0,n}$ [N/mm <sup>2</sup> ]				
$\tau_{Rk,cr} \cdot 0,575$	$\tau_{Rk,cr} \cdot 10^{(-0,06 \cdot \log(n))}$	$\tau_{Rk,cr} \cdot 10^{(-0,207 - 0,029 \cdot \log(n))}$	$\tau_{Rk,cr} \cdot 0,35$	
Characteristic concrete cone and splitting fatigue resistance				
Characteristic concrete fatigue resistance in uncracked concrete				
$\Delta N_{Rk,c/sp,ucr,0,n}$ [kN]				
$N_{Rk,c/sp,ucr} \cdot 0,66$	$N_{Rk,c/sp,ucr} \cdot 1,1 \cdot n^{-0,055} \geq N_{Rk,c/sp,ucr} \cdot 0,50$			$N_{Rk,c/sp,ucr} \cdot 0,50$
Characteristic concrete fatigue resistance in cracked concrete				
$\Delta N_{Rk,c/sp,cr,0,n}$ [kN]				
$N_{Rk,c/sp,cr} \cdot 0,66$	$N_{Rk,c/sp,cr} \cdot 1,1 \cdot n^{-0,055} \geq N_{Rk,c/sp,cr} \cdot 0,50$			$N_{Rk,c/sp,cr} \cdot 0,50$
Exponents and load transfer factor				
Exponent for combined loading				
	M12	M16	M20	M24
$\alpha_s = \alpha_{sn}$ [-]	0,5		0,7	
Load transfer factor				
$\psi_{FN}$ [-]	0,5			
$N_{Rk,s}$ , $\tau_{Rk,ucr}$ , $\tau_{Rk,cr}$ see ETA-17/0979 of 16.12.2025, for $\tau_{Rk}$ (M24-R-70) $\leq 0,85 \cdot \tau_{Rk}$ (M20-R-70) $N_{Rk,c/sp,ucr}$ , $N_{Rk,c/sp,cr}$ see ETA-17/0979 of 16.12.2025 and EN 1992-4:2018				
<b>fischer FIS EM Plus dynamic</b>				<b>Annex C1</b> Appendix 16 / 19
<b>Performance</b> Essential characteristics under tension fatigue loading; Design method I according to TR 061				

**Table C2.1:** Essential characteristics under shear fatigue loading for FIS EM Plus;  
**Design method I according to TR 061**

Required evidence				
Number of load cycles (n)				
$n \leq 10^4$	$10^4 < n \leq 5 \cdot 10^6$	$5 \cdot 10^6 < n \leq 10^8$	$n > 10^8$	
Shear loading				
Characteristic steel fatigue resistance (zinc plated steel 8.8)				
$\Delta V_{Rk,s,0,n}$ (8.8) [kN]				
$V_{Rk,s,(8.8)} \cdot 0,23$	$V_{Rk,s,(8.8)} \cdot 10^{(-0,147 \cdot \log(n))} \leq V_{Rk,s,(8.8)} \cdot 0,23$	$V_{Rk,s,(8.8)} \cdot 10^{(-0,573 - 0,068 \cdot \log(n))} \geq V_{Rk,s,(8.8)} \cdot 0,08$	$V_{Rk,s,(8.8)} \cdot 0,08$	
Characteristic steel fatigue resistance (stainless steel R, property class 70)				
$\Delta V_{Rk,s,0,n}$ (R-70) [kN]				
$V_{Rk,s,(R-70)} \cdot 0,31$	$V_{Rk,s,(R-70)} \cdot 10^{(-0,042 - 0,118 \cdot \log(n))}$	$V_{Rk,s,(R-70)} \cdot 10^{(-0,461 - 0,056 \cdot \log(n))}$	$V_{Rk,s,(R-70)} \cdot 0,12$	
Characteristic concrete pry out fatigue resistance in cracked and uncracked concrete				
$\Delta V_{Rk,cp,0,n}$ [kN]				
$V_{Rk,cp} \cdot 0,574$	$V_{Rk,cp} \cdot 1,2 \cdot n^{-0,08} \geq V_{Rk,cp} \cdot 0,50$			$V_{Rk,cp} \cdot 0,50$
Characteristic concrete edge fatigue resistance in cracked and uncracked concrete				
$\Delta V_{Rk,c,0,n}$ [kN]				
$V_{Rk,c} \cdot 0,574$	$V_{Rk,c} \cdot 1,2 \cdot n^{-0,08} \geq V_{Rk,c} \cdot 0,50$			$V_{Rk,c} \cdot 0,50$
Exponents, load transfer factor				
Exponent for combined loading, steel failure				
	M12	M16	M20	M24
$\alpha_s = \alpha_{sn}$	[-]	0,5	0,7	
Exponent for combined loading, verification regarding failure modes other than steel failure				
$\alpha_c$	[-]	1,5		
Load transfer factor				
$\psi_{FV}$	[-]	0,5		
$V_{Rk,s}$ see ETA-17/0979 of 16.12.2025 $V_{Rk,c}, V_{Rk,cp}$ see ETA-17/0979 of 16.12.2025 and EN 1992-4:2018				
<b>fischer FIS EM Plus dynamic</b>				<b>Annex C2</b> Appendix 17 / 19
<b>Performance</b> Essential characteristics under shear fatigue loading; Design method I according to TR 061				

**Table C3.1: Essential characteristics under tension and shear fatigue loading; Design method II according to TR 061; zinc plated steel 8.8**

Size			M12	M16
<b>Tension loading</b>				
Effective embedment depth	$h_{ef,min}$	[mm]	95	125
<b>Steel failure</b>				
Characteristic steel fatigue resistance	$\Delta N_{Rk,s,0,\infty}$	[kN]	6,1	11,3
Exponent for combined loading	$\alpha_s = \alpha_{sn}$	[-]	0,5	0,7
<b>Combined pull-out / concrete cone failure</b>				
Characteristic bond fatigue resistance	$\Delta \tau_{Rk,p,ucr,0,\infty}$	[N/mm <sup>2</sup> ]	$\tau_{Rk,ucr} \cdot 0,35$	
	$\Delta \tau_{Rk,p,cr,0,\infty}$	[N/mm <sup>2</sup> ]	$\tau_{Rk,cr} \cdot 0,35$	
<b>Concrete cone failure and concrete splitting failure</b>				
Characteristic concrete fatigue resistance	$\Delta N_{Rk,c,0,\infty}$	[-]	$0,5 \cdot N_{Rk,c}^{1)}$	
	$\Delta N_{Rk,sp,0,\infty}$	[-]	$0,5 \cdot N_{Rk,sp}^{1)}$	
Exponent for combined loading	$\alpha_c$	[-]	1,5	
Load transfer factor	$\Psi_{FN}$	[-]	0,5	
<b>Shear loading</b>				
<b>Shear loading, steel failure without lever arm</b>				
Characteristic steel fatigue resistance	$\Delta V_{Rk,s,0,\infty}$	[kN]	2,7	5,0
Exponent for combined loading	$\alpha_s = \alpha_{sn}$	[-]	0,5	0,7
<b>Concrete pryout failure</b>				
Characteristic concrete fatigue resistance	$\Delta V_{Rk,cp,0,\infty}$	[kN]	$0,5 \cdot V_{Rk,cp}^{1)}$	
<b>Concrete edge failure</b>				
Characteristic concrete fatigue resistance	$\Delta V_{Rk,c,0,\infty}$	[kN]	$0,5 \cdot V_{Rk,c}^{1)}$	
Effective length of fastener	$l_f$	[mm]	$\min(h_{ef}, 12 \cdot d_{nom})$	
Effective outside diameter of the anchor	$d_{nom}$	[mm]	12	16
Exponent for combined loading	$\alpha_c$	[-]	1,5	
Load transfer factor	$\Psi_{FV}$	[-]	0,5	

<sup>1)</sup>  $N_{Rk,c}$ ,  $N_{Rk,sp}$ ,  $V_{Rk,c}$  and  $V_{Rk,cp}$  – Essential characteristics for concrete failure under static and quasi-static loading according to ETA-17/0979 of 16.12.2025 and EN 1992-4:2018.

**fischer FIS EM Plus dynamic**

**Performance**

Essential characteristics under tension / shear fatigue loading; Design method II according to TR 061; zinc plated steel 8.8

**Annex C3**

Appendix 18 / 19

**Table C4.1: Essential characteristics under tension and shear fatigue loading;  
Design method II according to TR 061; stainless steel R property class 70**

Size			M12	M16	M20	M24
<b>Tension loading</b>						
Effective embedment depth	$h_{ef,min}$	[mm]	95	125	160	190
<b>Steel failure</b>						
Characteristic steel fatigue resistance	$\Delta N_{Rk,s,0,\infty}$	[kN]	6,6	12,4	19,4	27,8
Exponent for combined loading	$\alpha_s = \alpha_{sn}$	[-]	0,5	0,7		
<b>Combined pull-out / concrete cone failure</b>						
Characteristic bond fatigue resistance	$\Delta \tau_{Rk,p,ucr,0,\infty}$	[N/mm <sup>2</sup> ]	$\tau_{Rk,ucr} \cdot 0,35$			
	$\Delta \tau_{Rk,p,cr,0,\infty}$	[N/mm <sup>2</sup> ]	$\tau_{Rk,cr} \cdot 0,35$			
<b>Concrete cone failure and concrete splitting failure</b>						
Characteristic concrete fatigue resistance	$\Delta N_{Rk,c,0,\infty}$	[-]	$0,5 \cdot N_{Rk,c}^{1)}$			
	$\Delta N_{Rk,sp,0,\infty}$	[-]	$0,5 \cdot N_{Rk,sp}^{1)}$			
Exponent for combined loading	$\alpha_c$	[-]	1,5			
Load transfer factor	$\Psi_{FN}$	[-]	0,5			
<b>Shear loading</b>						
<b>Shear loading, steel failure without lever arm</b>						
Characteristic steel fatigue resistance	$\Delta V_{Rk,s,0,\infty}$	[kN]	3,6	6,6	10,3	14,9
Exponent for combined loading	$\alpha_s = \alpha_{sn}$	[-]	0,5	0,7		
<b>Concrete pryout failure</b>						
Characteristic concrete fatigue resistance	$\Delta V_{Rk,cp,0,\infty}$	[kN]	$0,5 \cdot V_{Rk,cp}^{1)}$			
<b>Concrete edge failure</b>						
Characteristic concrete fatigue resistance	$\Delta V_{Rk,c,0,\infty}$	[kN]	$0,5 \cdot V_{Rk,c}^{1)}$			
Effective length of fastener	$l_f$	[mm]	$\min(h_{ef}, 12 \cdot d_{nom})$			
Effective outside diameter of the anchor	$d_{nom}$	[mm]	12	16	20	24
Exponent for combined loading	$\alpha_c$	[-]	1,5			
Load transfer factor	$\Psi_{FV}$	[-]	0,5			

<sup>1)</sup>  $N_{Rk,c}$ ,  $N_{Rk,sp}$ ,  $V_{Rk,c}$  and  $V_{Rk,cp}$  – Essential characteristics for concrete failure under static and quasi-static loading according to ETA-17/0979 of 16.12.2025 and EN 1992-4:2018, for  $\tau_{Rk}(M24-R-70) \leq 0,85 \cdot \tau_{Rk}(M20-R-70)$

**fischer FIS EM Plus dynamic**

**Performance**

Essential characteristics under tension / shear fatigue loading;  
Design method II according to TR 061; stainless steel R property class 70

**Annex C4**

Appendix 19 / 19