



## VYHLÁSENIE O PARAMETROCH

### DoP 0269

pre fischer Ceiling Anchor FDZ (mechanická kotva do betónu)

SK

1. Jedinečný identifikačný kód typu výrobku: DoP 0269
2. Zamýšľané použitie/použitia: Dodatočné, viacnásobné upevnenie v betóne pre nenosné konštrukcie, pozri prílohu, najmä prílohy B1 - B2.
3. Výrobca: fischerwerke GmbH & Co. KG, Klaus-Fischer-Str. 1, 72178 Waldachtal, Nemecko
4. Splnomocnený zástupca: -
5. Systém(-y) posudzovania a overovania nemennosti parametrov: 2+
6. Európsky hodnotiaci dokument: ETAG 001, Part 6, April 2013, v zmysle EAD  
Európske technické posúdenie: ETA-17/0737; 2018-01-30  
Orgán technického posudzovania: DIBt- Deutsches Institut für Bautechnik  
Notifikovaný(-é) subjekt(-y): 2873 TU Darmstadt
7. Deklarované parametre:  
**Bezpečnosť pri používaní (BWR 4)**  
**Charakteristická odolnosť v ťahu (statické a kvázistatické zaťaženie):**  
Odolnosť voči porušeniu ocele: NPD  
Odolnosť voči porušeniu vytiahnutím: NPD  
Odolnosť voči porušeniu betónového kužeľa: NPD  
Robustnosť: Príloha C1  
Minimálna vzdialenosť od okraj a osová vzdialenosť: Prílohy B2, C1  
Vzdialenosť od okraj voči rozštiepiu pri zaťažení: NPD  
  
**Charakteristická odolnosť v šmyku (statické a kvázistatické zaťaženie):**  
Odolnosť voči porušeniu ocele (Zaťaženie šmykom): Príloha C1  $V_{Rk,s}=NPD; k_7=NPD$   
Odolnosť voči vylomeniu: NPD  
Odolnosť voči poškodeniu hrany betónu: NPD  
  
**Charakteristická únosnosť pre všetky smery zaťaženia a spôsoby porušenia pre zjednodušený návrh:**  
Charakteristická únosnosť: Príloha C1  
  
**životnosť:**  
životnosť: Príloha B1  
  
**Bezpečnosť v prípade požiaru (BWR 2)**  
Reakcia na oheň: Trieda (A1)  
**Odolnosť proti ohňu:**  
Požiarna odolnosť voči porušeniu ocele (Zaťaženie ťahom): NPD  
Požiarna odolnosť voči vytiahnutiu (Zťaženie ťahom): NPD  
Požiarna odolnosť voči porušeniu ocele (Zaťaženie šmykom): NPD  
Požiarna odolnosť pre všetky smery zaťaženia a spôsoby poruchy: Príloha C1
8. Vhodná technická dokumentácia a/alebo špecifická technická dokumentácia: -

Uvedené parametre výrobku sú v zhode so súborom deklarovanych parametrov. Toto vyhlásenie o parametroch sa v súlade s nariadením (EÚ) č. 305/2011 vydáva na výhradnú zodpovednosť uvedeného výrobcu.

Podpísal(-a) za a v mene výrobcu:

Dr.-Ing. Oliver Geibig, konateľ oddelenia Produkt management & vývoj  
Tumlingen, 2021-01-11

Jürgen Grün, konateľ oddelenia Chemická výroba & kvalita

Toto vyhlásenie o vlastnostiach bolo vyhotovené v rôznych jazykoch. V prípade, že dôjde k rozdielnemu výkladu má anglická verzia vždy prednosť.

Príloha obsahuje dobrovoľné a doplňujúce informácie v anglickom jazyku. Tieto vychádzajú zo zákonom stanovených požiadaviek (jazykovo neutrálnych).

## Specific Part

### 1 Technical description of the product

The fischer Ceiling Anchor FDZ is an anchor made of galvanized steel which is placed into a drilled hole and anchored by deformation-controlled expansion.

The product description is given in Annex A.

### 2 Specification of the intended use in accordance with the applicable European Assessment Document

The performances given in Section 3 are only valid if the anchor is used in compliance with the specifications and conditions given in Annex B.

The verifications and assessment methods on which this European Technical Assessment is based lead to the assumption of a working life of the anchor of at least 50 years. The indications given on the working life cannot be interpreted as a guarantee given by the producer, but are to be regarded only as a means for choosing the right products in relation to the expected economically reasonable working life of the works.

### 3 Performance of the product and references to the methods used for its assessment

#### 3.1 Mechanical resistance and stability (BWR 1)

The essential characteristics regarding mechanical resistance and stability are included under the Basic Works Requirement Safety in use.

#### 3.2 Safety in case of fire (BWR 2)

Essential characteristic	Performance
Reaction to fire	Anchorage satisfy requirements for Class A1
Resistance to fire	See Annex C 1

#### 3.3 Safety in use (BWR 4)

Essential characteristic	Performance
Characteristic resistance in concrete	See Annex C 1

### 4 Assessment and verification of constancy of performance (AVCP) system applied, with reference to its legal base

In accordance with guideline for European technical approval ETAG 001, April 2013 used as European Assessment Document (EAD) according to Article 66 Paragraph 3 of Regulation (EU) No 305/2011 the applicable European legal act is: [97/161/EC].

The system to be applied is: 2+

# Product installation conditions, product marking and product dimensions

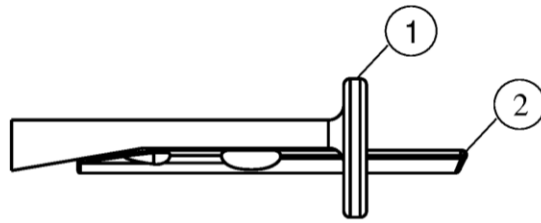

- ① Shaft
- ② Pin

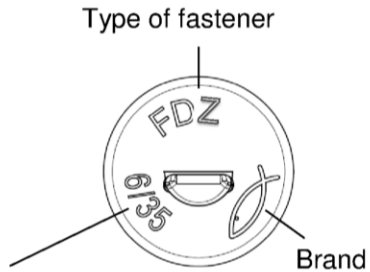
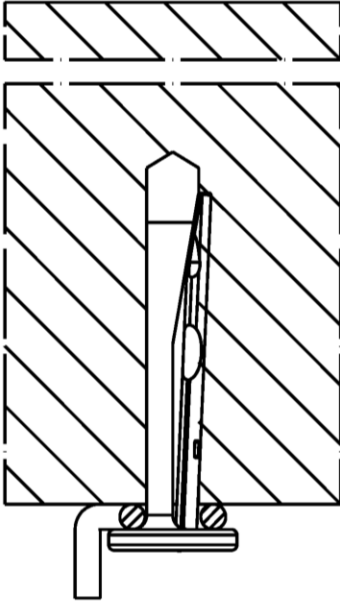

Nominal diameter / max. thickness of the fixture;  
Additional marking "K" for  $h_{ef} = 25$  mm

**Table A1.1: Dimensions**

Size	FDZ			
	6/5 K	6/5	6/35 K	6/35
Length of the $\frac{\text{pin}}{\text{shaft}}$ $L_1$	36	43	66	73
$L_2$ [mm]	30,5	37,5	60,5	67,5
Diameter of the head $D \geq$	13			

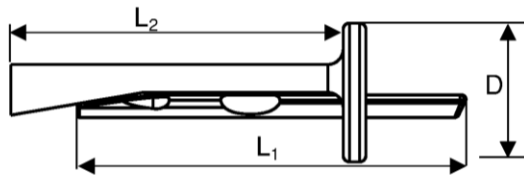

(Fig. not to scale)

**fischer Ceiling Anchor FDZ**

**Product description**

Product installation conditions, product marking and product dimensions

**Annex A 1**

Appendix 2 / 5

## Specifications of intended use

### Anchorage subject to:

Size	FDZ 6
Static and quasi-static loads	
Use for multiple fixture of non-structural applications according to ETAG 001, Part 6	✓
Fire exposure	

### Base materials:

- Reinforced and unreinforced normal weight concrete according to EN 206-1:2000
- Strength classes C12/15 to C50/60 according to EN 206-1:2000
- Cracked and non-cracked concrete

### Use conditions (Environmental conditions):

- Anchorage subject to dry internal conditions

### Design:

- Anchorages are designed under the responsibility of an engineer experienced in anchorages and concrete work
- Verifiable calculation notes and drawings have to be prepared taking account of the loads to be anchored. The position of the anchor is indicated on the design drawings (e.g. position of the anchor relative to reinforcement or to supports, etc.).
- Anchorages under static or quasi-static actions have to be designed for Design Method C in accordance with:
  - ETAG 001, Annex C, Design Method C, Edition August 2010
  - CEN/TS 1992-4:2009
- Anchorages under fire exposure have to be designed in accordance with
  - EOTA Technical Report TR 020, Edition May 2004
  - CEN/TS 1992-4:2009, Annex D (it must be ensured that local spalling of the concrete cover does not occur)

**fischer Ceiling Anchor FDZ**

**Intended use**  
Specifications

**Annex B 1**

Appendix 3 / 5

**Table B2.1:** Installation parameters

Size			FDZ				
			6/5 K	6/5	6/35 K	6/35	
Thickness of the fixture	$t_{fix}$	$\leq$	5		35		
Nominal drill hole diameter	$d_0$		6				
Diameter of clearance hole in the fixture	$d_f$	$\leq$	7				
Maximum bit diameter	$d_{cut,max}$		6,40				
Effective embedment depth	$h_{ef}$	[mm]	25	32	25	32	
Depth of drill hole to deepest point	with hole cleaning	$h_1$	$\geq$	30	37	30	37
	without hole cleaning			35	42	35	42
Minimum thickness of concrete member	$h_{min}$		80				

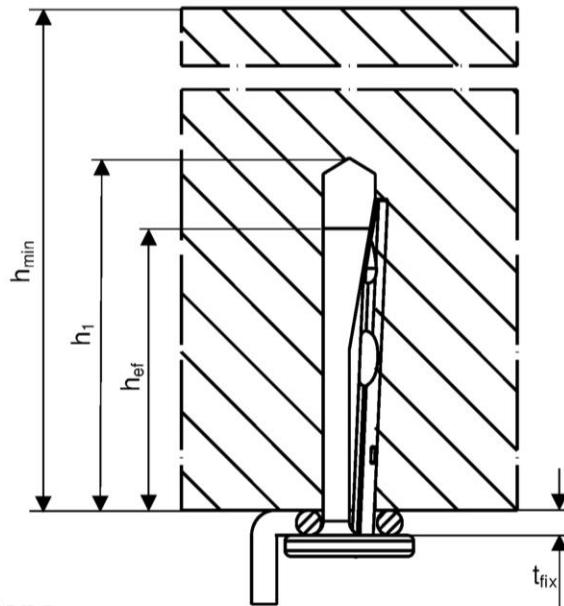

**Installation instructions**

- Hammer or hollow drilling only
- Anchor installation carried out by appropriately qualified personnel and under the supervision of the person responsible for technical matters of the site
- Positioning of the drill holes without damaging the reinforcement
- In case of aborted hole: New drilling at a minimum distance twice the depth of aborted hole away of or smaller distance if the aborted hole is filled with high strength mortar and if under shear or oblique tension load it is not in the direction of the load application

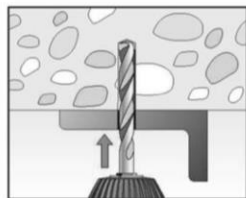

1: Drill the hole

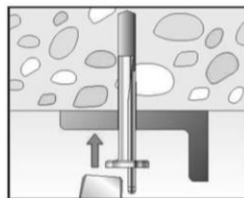

2: Set the fastener

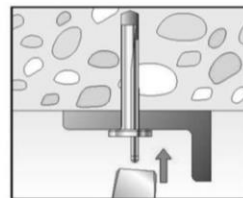

3: Set the pin, until flush to the surface

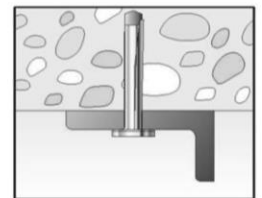

4: Installed fastener

(Fig. not to scale)

**fischer Ceiling Anchor FDZ**

**Intended use**

Installation parameters and installation instructions

**Annex B 2**

Appendix 4 / 5

<b>Table C1.1: Characteristic resistance</b>			
Size		<b>FDZ 6</b>	
<b>For all load directions and for all failures modes</b>			
Effective embedment depth	$h_{ef}$ [mm]	25	32
Characteristic resistance in cracked and non-cracked concrete	C12/15	1,0	1,5
	C20/25 to C50/60	1,5	2,0
Characteristic edge distance	$c_{cr,N} = c_{min}$ [mm]	70	60
	spacing	$s_{cr,N} = s_{min}$	60
Partial safety factor	$\gamma_M^{2)}$ [-]	1,5	
<b>Shear load with lever arm</b>			
Characteristic bending resistance	$M_{Rk,s}^0$ [Nm]	4,4	
Partial safety factor for steel failure	$\gamma_{Ms}^1)$ [-]	1,25	
<sup>1)</sup> In absence of other national regulations <sup>2)</sup> The installation safety factor $\gamma_2 = \gamma_{inst} = 1,0$ is included			

**Table C1.2: Characteristic resistance under fire exposure for all effective embedment depths**

Size		<b>FDZ 6</b>	
<b>Steel failure for tension and shear load</b>			
R30	Characteristic resistance	$F_{Rk,s,fi30}$	1,00
R60		$F_{Rk,s,fi60}$	0,50
R90		$F_{Rk,s,fi90}$ [kN]	0,34
R120		$F_{Rk,s,fi120}$	0,26
R180		$F_{Rk,s,fi180}$	0,17
<b>Spacing and edge distance</b>			
R30 – R120		$s_{cr,fi}$ [mm]	200
		$c_{cr,fi}$	150
For fire exposure from more than one side $c_{min} \geq 300$ mm			
<b>fischer Ceiling Anchor FDZ</b>			<b>Annex C 1</b>
<b>Performances</b>			
Characteristic resistance and characteristic resistance under fire exposure			
			Appendix 5 / 5