



DECLARAȚIA DE PERFORMANȚĂ

DoP 0165

pentru ancora fischer Superbond dynamic (Ancore din adezivă pentru utilizare în beton)

RO

1. Cod unic de identificare al produsului-tip: **DoP 0165**
2. Utilizare (utilizări) preconizată (preconizate): **Ancore post-instalate pentru utilizare în beton sub încărcare ciclică de oboseală, consultați suplimentul, în special anexele B1-B16.**
3. Fabricant: **fischerwerke GmbH & Co. KG, Otto-Hahn-Straße 15, 79211 Denzlingen, Germany**
4. Reprezentant autorizat: **-**
5. Sistemul (sistemele) de evaluare și de verificare a constantei performanței: **1**
6. Documentul de evaluare european: **EAD 330250-00-0601, previously referred as EAD 330250-01-0601**
Evaluarea tehnică europeană: **ETA-19/0501; 2021-01-22**
Organismul de evaluare tehnică: **DIBt- Deutsches Institut für Bautechnik**
Organism (organisme) notificat(e): **2873 TU Darmstadt**
7. Performanța (performanțe) declarată (declarate):
EAD 330250-00-0601, Tabel 2.5, Metoda de evaluare C: Funcție liniarizată
Rezistență mecanică și stabilitate (BWR 1)
Rezistența caracteristică la oboseală a oțelului sub sarcină de întindere:
Anexele C1, C3, C4
Rezistența caracteristică la oboseală pentru cedarea conului de beton, smulgere, despicare și rupere sub sarcină de întindere: Anexele C1, C3, C4
Rezistența caracteristică la oboseală pentru smulgere sau combinația smulgere/cedare con de beton sub sarcină de întindere: Anexele C1, C3, C4
Rezistența caracteristică la oboseală a oțelului sub sarcină de forfecare: Anexele C2-C4

Rezistența caracteristică la oboseală pentru cedarea marginii betonului sub sarcină de forfecare: Anexele C2-C4

Rezistența caracteristică la oboseală la cedarea cu braț de levier sub sarcină de forfecare: Anexele C2-C4

Rezistența caracteristică la oboseală a oțelului sub sarcină de întindere și forfecare: Anexele C1-C4

Factorul de transfer al sarcinii pentru întindere și forfecare: Anexele C1-C4
8. Documentație tehnică adecvată și/sau documentație tehnică specifică: **-**

Performanța produsului identificat mai sus este în conformitate cu setul de performanțe declarate. Această declarație de performanță este eliberată în conformitate cu Regulamentul (UE) nr. 305/2011, pe răspunderea exclusivă a fabricantului identificat mai sus.

Semnată pentru și în numele fabricantului de către:

Dr. Oliver Geibig, Director Executiv Departament Business & Inginerie
Tumlingen, 2021-01-29

Jürgen Grün, Director Executiv Departament Chimic & Calitate

Această declarație de performanță a fost întocmită în mai multe limbi. În cazul unei divergențe de interpretare, versiunea în limba engleză prevalează întotdeauna.

Suplimentul include informații voluntare și complementare în limba engleză, în afara cerințelor legale (specificate neutru din punct de vedere al limbii).

Specific Part

1 Technical description of the product

The Fischer Superbond Dynamic is a bonded anchor consisting of a cartridge with injection mortar FIS SB or FIS SB High Speed or mortar capsule RSB, an anchor rod FIS A or RG M, a centering sleeve (only for push-through installation), a conical washer with bore, a hexagon nut with spherical contact surface and a locknut. Alternatively the hexagon nut with spherical contact surface can be replaced by a spherical disc with hexagon nut. For the sizes M20 and M24, the variant with centering sleeve, washer, hexagon nut and lock nut is available as an alternative for push-through installation.

The steel element is placed into a drilled hole filled with injection mortar and is anchored via the bond between metal part, injection mortar and concrete.

The resin capsule is placed into the hole and the steel element is driven by machine with simultaneous hammering and turning. The anchor rod is anchored via the bond between steel element, chemical mortar and concrete.

The product description is given in Annex A.

2 Specification of the intended use in accordance with the applicable European Assessment Document

The performances given in Section 3 are only valid if the anchor is used in compliance with the specifications and conditions given in Annex B.

The verifications and assessment methods on which this European Technical Assessment is based lead to the assumption of a working life of the anchor of at least 50 years. The indications given on the working life cannot be interpreted as a guarantee given by the producer, but are to be regarded only as a means for choosing the right products in relation to the expected economically reasonable working life of the works.

3 Performance of the product and references to the methods used for its assessment

3.1 Mechanical resistance and stability (BWR 1)

Essential characteristic	Performance
Assessment method C: Linearized function	
Characteristic steel fatigue resistance under tension loading	See Annex C1, C3 and C4
Characteristic concrete cone, pull-out, splitting and blow out fatigue resistance under tension loading	See Annex C1, C3 and C4
Characteristic pull-out or combined pull-out /concrete cone fatigue resistance under tension loading	See Annex C1, C3 and C4
Characteristic steel fatigue resistance under shear loading	See Annex C2, C3 and C4
Characteristic concrete edge fatigue resistance under shear loading	See Annex C2, C3 and C4
Characteristic concrete pry-out fatigue resistance under shear loading	See Annex C2, C3 and C4
Characteristic steel fatigue resistance under tension and shear	See Annex C1 to C4

Essential characteristic	Performance
Load transfer factor for tension and shear loading	See Annex C1 to C4

4 Assessment and verification of constancy of performance (AVCP) system applied, with reference to its legal base

In accordance with European Assessment Document No. 330250-01-0601, the applicable European legal act is: [96/582/EC].

The system to be applied is: 1

Installation conditions

fischer anchor rod FIS A or RG M with fischer injection system FIS SB

Pre-positioned installation with the necessary components (annular gap filled with mortar)

Size: M12, M16, M20, M24

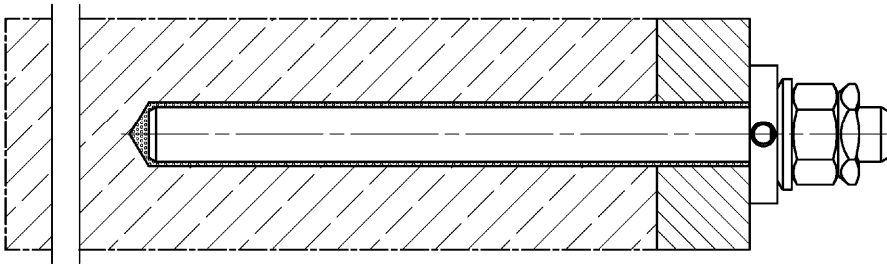

Push through installation with the necessary components (annular gap filled with mortar)

Size: M12, M16, M20, M24

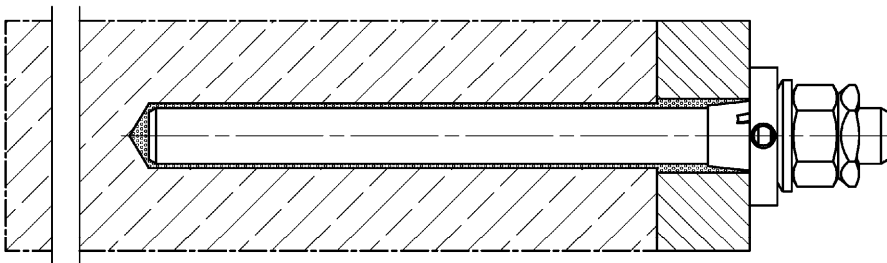

Push through installation with the necessary components (annular gap filled with mortar)

Size: M20, M24

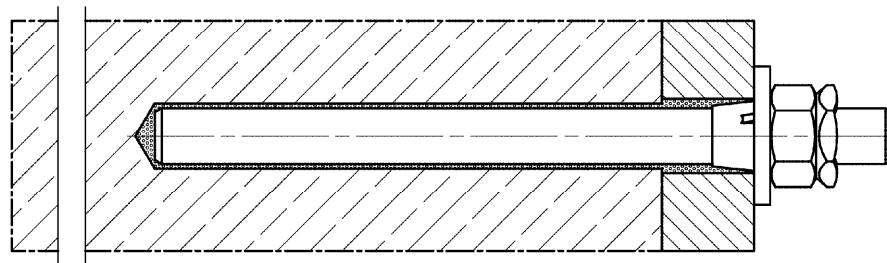

fischer anchor rod RG M with fischer mortar capsule system RSB

Pre-positioned or push through installation with the necessary components (annular gap filled with mortar)

Size: M12, M16, M20, M24

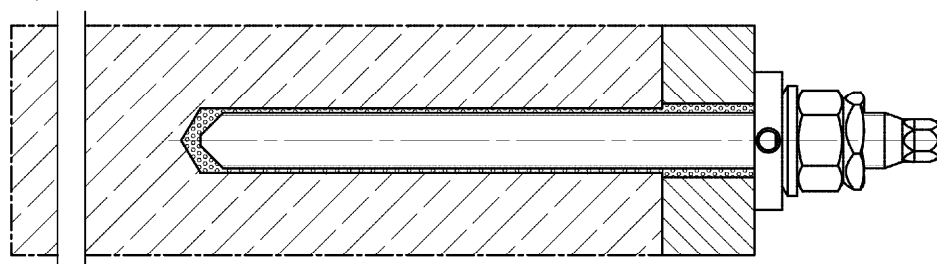

Figures not to scale

fischer Superbond dynamic

Product description
Installation conditions

Annex A 1

Appendix 3 / 26

Overview system components Part 1

Mortar cartridge (shuttle cartridge) with sealing cap; Size: 390 ml, 585 ml, 1100 ml, 1500 ml

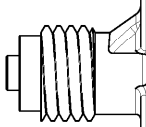
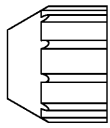

Imprint: fischer FIS SB, FIS SB High Speed, processing notes, shelf-life, piston travel scale (optional), curing times and processing times (depending on temperature), hazard code, size, volume



Mortar cartridge (coaxial cartridge) with sealing cap; Size: 150 ml, 300 ml ,380 ml, 410 ml

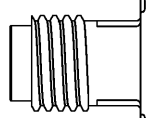
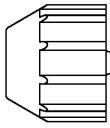

Imprint: fischer FIS SB, FIS SB High Speed, processing notes, shelf-life, piston travel scale (optional), curing times and processing times (depending on temperature), hazard code, size, volume



Mortar capsule

Size: 12 mini, 12, 16 mini, 16, 20, 20 E /24



Static mixer FIS MR Plus for injection cartridges up to 410 ml

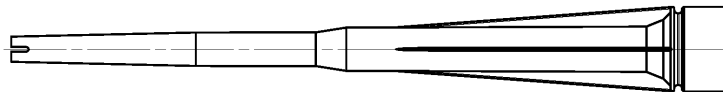

Static mixer FIS UMR for injection cartridges from 585 ml

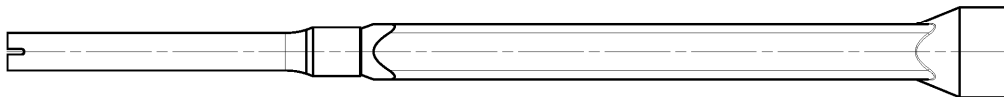

**Injection adapter and extension tube Ø 9 for static mixer FIS MR Plus;
Injection adapter and extension tube Ø 9 or Ø 15 for static mixer FIS UMR**

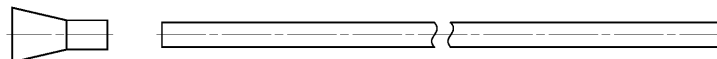

Figures not to scale

fischer Superbond dynamic

System description

Overview system components part 1;
cartridges / capsule / static mixer / injection adapter

Annex A 2

Appendix 4 / 26

Overview system components Part 2

fischer anchor rod FIS A

Size: M12, M16, M20, M24

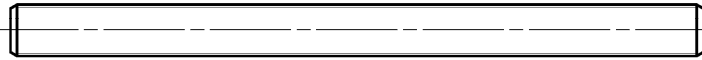

fischer anchor rod RG M

Size: M12, M16, M20, M24



spherical washer

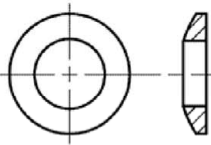

conical washer (various versions; partly fillable)

without drill hole



radial

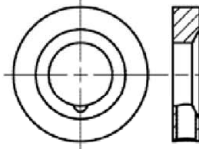

angular

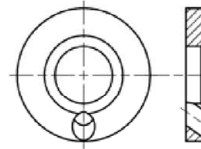

axial

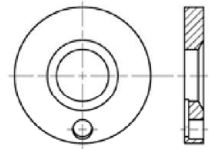

centering sleeve

(only push through installation)

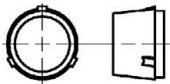

washer

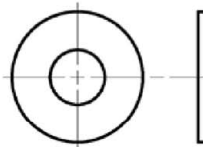

hexagonal nut with spherical contact surface

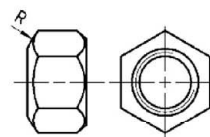

hexagon nut

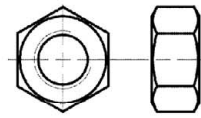

lock nut

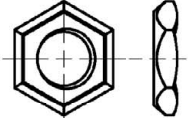

Injection adapter

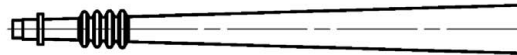

Cleaning brush BS



Blow-out pump ABP with cleaning nozzle or ABG

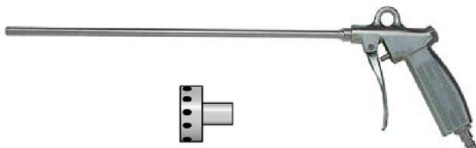

Figures not to scale

fischer Superbond dynamic

System description

Overview system components part 2;
Steel components / injection adapter / cleaning brush / blow-out pump

Annex A 3

Appendix 5 / 26

Table A4.1: Materials

Part	Designation	Material	
1	Injection cartridge	Mortar, hardener, filler	
2	Resin capsule	Mortar, hardener, filler	
	Steel grade	Steel	Stainless steel R
		zinc plated	acc. to EN 10088-1:2014 Corrosion resistance class CRC III acc. to EN 1993-1-4:2015
3	fischer anchor rod FIS A or RG M	Property class 8.8; EN ISO 898-1:2013 zinc plated $\geq 5 \mu\text{m}$ EN ISO 4042:2018/Zn5/An (A2K) $f_{uk} \leq 1000 \text{ N/mm}^2$	Property class 70 EN ISO 3506-1:2009 1.4401 (M12 to M24) 1.4062 (M12 and M16) 1.4362 (M12 and M16) EN 10088-1:2014 $f_{uk} \leq 1000 \text{ N/mm}^2$
4	Centering sleeve	Plastic	
5a	Washer ISO 7089:2000	---	1.4401; 1.4404; 1.4578; 1.4571; 1.4439; 1.4362; EN 10088-1:2014
5b	Fillable conical washer similar to DIN 6319-G	zinc plated $\geq 5 \mu\text{m}$, EN ISO 4042: 2018/Zn5/An (A2K)	1.4401; 1.4404; 1.4578; 1.4571; 1.4439; 1.4362; EN 10088-1:2014
6	Spherical washer	zinc plated $\geq 5 \mu\text{m}$, EN ISO 4042: 2018/Zn5/An (A2K)	1.4401; 1.4404; 1.4578; 1.4571; 1.4439; 1.4362; EN 10088-1:2014
7a	Hexagon nut	Property class 8; EN ISO 898-2:2012 zinc plated $\geq 5 \mu\text{m}$, EN ISO 4042: 2018/Zn5/An (A2K)	Property class 80 EN ISO 3506-1:2009 1.4401; 1.4404; 1.4578; 1.4571; 1.4439; 1.4362; EN 10088-1:2014
7b	Hexagonal nut with spherical contact surface		
8	Lock nut	zinc plated $\geq 5 \mu\text{m}$, EN ISO 4042: 2018/Zn5/An (A2K)	1.4401; 1.4404; 1.4578; 1.4571; 1.4439; 1.4362; EN 10088-1:2014

fischer Superbond dynamic

Product description
Materials
Annex A 4

Appendix 6 / 26





Specifications of intended use (part 1)

Table B1.1: Overview use and performance categories injection motar system

		FIS SB with	
		fischer anchor rod FIS A or fischer anchor rod RG M	
Hammer drilling with standard drill bit		Nominal drill bit diameter (d_0) 14 mm to 28 mm	
Hammer drilling with hollow drill bit (fischer "FHD", Heller "Duster Expert"; Bosch "Speed Clean"; Hilti "TE-CD, TE-YD"; DreBo „D-Plus“; DreBo „D-Max“)			
Diamond drilling		no performance assessed	
Fatigue load, in	uncracked concrete cracked concrete	Steel, zinc plated: M12 and M16	Stainless steel R: M12, M16, M20 and M24
Design method I acc. to EOTA TR 061:2020-08	$n = 1$ to $n = \infty$		
Design method II acc. to EOTA TR 061:2020-08	$n = \infty$		
Use category I1 dry or wet concrete	M12, M16, M20 and M24		
Installation direction	D3 Downwards, horizontal and upwards (overhead) installation		
Installation method	pre-positioned or push through installation		
Installation temperature	FIS SB: $T_{i,min} = -15\text{ °C}$ to $T_{i,max} = +40\text{ °C}$ FIS SB High Speed: $T_{i,min} = -20\text{ °C}$ to $T_{i,max} = +40\text{ °C}$		
In-service temperature	Temperature range I:	-40 °C to +40 °C	(max. short term temperature +40 °C; max. long term temperature +24 °C)
	Temperature range II:	-40 °C to +80 °C	(max. short term temperature +80 °C; max. long term temperature +50 °C)
fischer Superbond dynamic		Annex B 1 Appendix 7 / 26	
Intended use Specifications injection motar system FIS SB (part 1)			

Specifications of intended use (part 2)

Table B2.1: Overview use and performance categories resin capsule system

		RSB with	
		fischer anchor rod RG M	
			
Hammer drilling with standard drill bit			
Hammer drilling with hollow drill bit (fischer "FHD", Heller "Duster Expert"; Bosch „Speed Clean“; Hilti "TE-CD, TE-YD"; DreBo „D-Plus“; DreBo „D-Max“)		Nominal drill bit diameter (d_0) 14 mm to 28 mm	
Diamond drilling		Nominal drill bit diameter (d_0) 18 mm to 28 mm	
Fatigue load, in	uncracked concrete	Steel, zinc plated: M12 and M16	Stainless steel R: M12, M16, M20 and M24
	cracked concrete		
Design method I acc. to TR061:2020-08	$n = 1$ to $n = \infty$		
Design method II acc. to TR061:2020-08	$n = \infty$		
Use category I1 dry or wet concrete	M12, M16, M20 and M24		
Installation direction	D3 Downward, horizontal and upwards (overhead) installation		
Installation method	pre-positioned or push through installation		
Installation temperature	RSB: $T_{i,min} = -30\text{ °C}$ to $T_{i,max} = +40\text{ °C}$		
In-service temperature	Temperature range I:	-40 °C to +40 °C	(max. short term temperature +40 °C; max. long term temperature +24 °C)
	Temperature range II:	-40 °C to +80 °C	(max. short term temperature +80 °C; max. long term temperature +50 °C)
fischer Superbond dynamic			
Intended use Specifications resin capsule system RSB (part 2)		Annex B 2 Appendix 8 / 26	

Specifications of intended use (part 3)

Base materials:

- Compacted reinforced or unreinforced normal weight concrete without fibers of strength classes C20/25 to C50/60 according to EN 206:2013+A1:2016

Use conditions (Environmental conditions):

- Structures subject to dry internal conditions (zinc plated steel, stainless steel R).
- For all other conditions according to EN1993-1-4:2015 corresponding to corrosion resistance classes to Annex A 4 table A4.1.

Design:

- Anchorages have to be designed by a responsible engineer with experience of concrete anchor design.
- Verifiable calculation notes and drawings are to be prepared taking account of the loads to be anchored. The position of the anchor is indicated on the design drawings (e. g. position of the anchor relative to reinforcement or to supports, etc.).
- Anchorages have to be designed in accordance with:
 - EN 1992-4:2018 or
 - EOTA Technical Report TR 061 "Design method for fasteners in concrete under fatigue cyclic loading", Edition August 2020
- Static and quasi static loading see ETA-12/0258:2020
- Anchorages shall be positioned outside of critical regions (e.g. plastic hinges) of the concrete structure
- Fastenings in stand-off installation or with a grout layer are not covered by this European Technical Assessment (ETA)

Installation:

- Anchor installation is to be carried out by appropriately qualified personnel and under the supervision of the person responsible for technical matters of the site
- In case of aborted hole: The hole shall be filled with mortar
- Anchorage depth should be marked and adhered to on installation
- If only tension loads are involved in the application, the annular gap does not need to be filled
- Overhead installation is allowed

fischer Superbond dynamic

Intended use
Specifications (part 3)

Annex B 3

Appendix 9 / 26

Table B4.1: Installation parameters for fischer anchor rods in combination with injection mortar system FIS SB

fischer anchor rods		Thread	M12	M16	M20	M24
Material			zinc plated steel or stainless steel R		stainless steel R	
Width across flats	SW	[mm]	19	24	30	36
Nominal drill hole diameter	d ₀		14	18	24	28
Drill hole depth	h ₀		h ₀ = h _{ef}			
Effective embedment depth	h _{ef, min}		70	80	90	96
	h _{ef, max}		240	320	400	480
Minimum spacing and minimum edge distance	S _{min} = C _{min}		55	65	85	105
	Diameter of the clearance hole of the fixture		pre-positioned installation d _f	14-16	18-20	22-26
	push through installation d _f		15-16	19-20	25-26	29-30
Fixture thickness	t _{fix, min}		12	16	20	24
	t _{fix, max}		200			
Minimum thickness of concrete member	h _{min}	h _{ef} + 30	h _{ef} + 2d ₀	h _{ef} + 2d ₀	h _{ef} + 2d ₀	

Installation with conical washer

Protrusion anchor rod FIS A or RG M without hexagon head	h _{p, min}	[mm]	25 + t _{fix}	30 + t _{fix}	36 + t _{fix}	43 + t _{fix}
Protrusion anchor rod RG M (with hexagon head)	h _{p, min}		32 + t _{fix}	38 + t _{fix}	43 + t _{fix}	---

Installation with washer (M20 + M24)

Protrusion anchor rod FIS A or RG M without hexagon head	h _{p2, min}	[mm]	---	---	27 + t _{fix}	32 + t _{fix}
Protrusion anchor rod RG M (with hexagon head)	h _{p2, min}		---	---	34 + t _{fix}	---
Required installation torque	T _{inst}	[Nm]	40	60	120	150

fischer anchor rod FIS A or RG M



Marking (on random place) fischer anchor rod:

Property class 8.8: + or colour coding acc. to DIN 976-1:2016

Installation conditions see Annex B 5

Figures not to scale

fischer Superbond dynamic

Intended use

Installation parameters fischer anchor rods FIS A and RG M in combination with injection mortar system FIS SB

Annex B 4

Appendix 10 / 26

Installation conditions FIS A or RG M with conical washer or washer

Installation conditions FIS A or RG M with conical washer

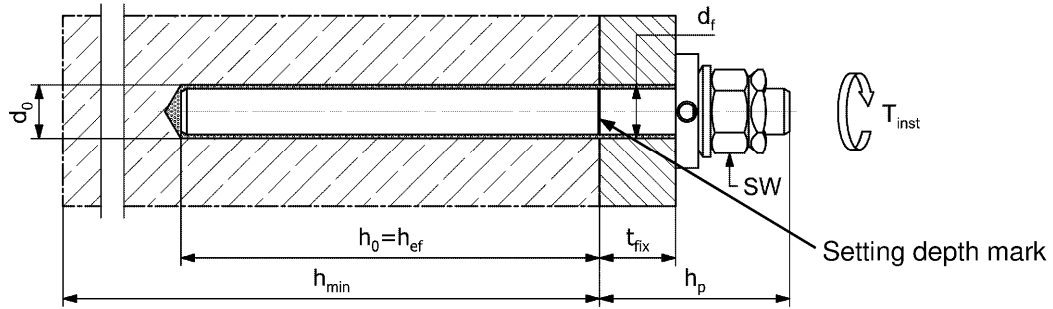

Installation conditions FIS A or RG M with washer

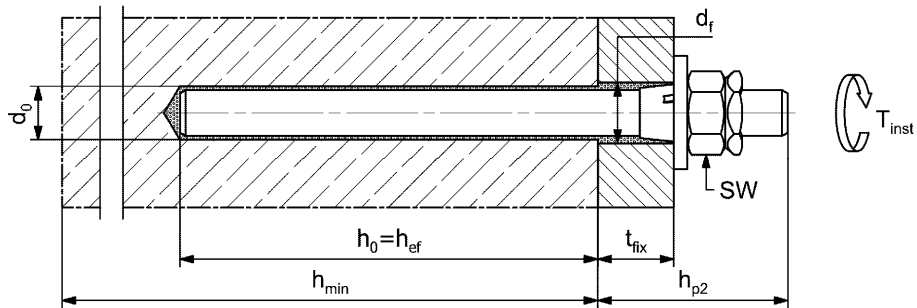

Installation conditions for RG M see Annex B 6

Figures not to scale

fischer Superbond dynamic

Intended use
Installation conditions FIS A or RG M with conical washer or washer

Annex B 5

Appendix 11 / 26

Table B6.1: Installation parameters for fischer anchor rods RG M in combination with resin capsule system RSB

fischer anchor rod RG M		Thread	M12	M16	M20	M24
Material			zinc plated steel or stainless steel R		stainless steel R	
Width across flats	SW	[mm]	19	24	30	36
Nominal drill hole diameter	d_0		14	18	25	28
Drill hole depth	h_0		$h_0 = h_{ef}$			
Effective embedment depth	$h_{ef,1}$		75	95	---	---
	$h_{ef,2}$		110	125	170	210
	$h_{ef,3}$		150	190	210	---
Minimum spacing and minimum edge distance	$s_{min} = c_{min}$		55	65	85	105
Diameter of the clearance hole of the fixture	pre-positioned installation d_f		14-16	18-20	22-26	26-30
	push through installation d_f		15-16	19-20	26	29-30
Fixture thickness	$t_{fix,min}$		12	16	20	24
	$t_{fix,max}$	200				
Minimum thickness of concrete member	h_{min}	$h_{ef} + 30$	$h_{ef} + 2d_0$	$h_{ef} + 2d_0$	$h_{ef} + 2d_0$	
Installation with conical washer						
Protrusion anchor rod RG M	$h_{p,min}$	[mm]	$32 + t_{fix}$	$38 + t_{fix}$	$43 + t_{fix}$	---
Protrusion anchor rod RG M without hexagon head	$h_{p,min}$		---	---	---	$43 + t_{fix}$
Required installation torque	T_{inst}	[Nm]	40	60	120	150

fischer anchor rod RG M

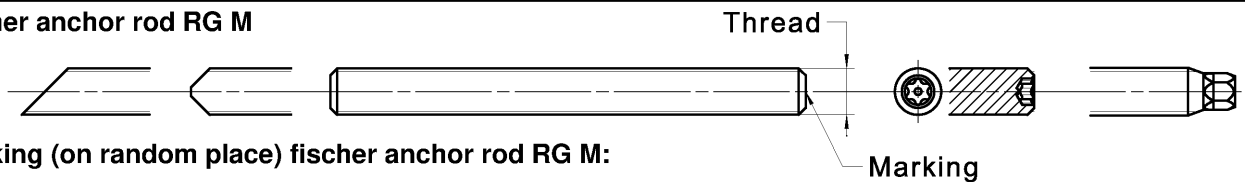

Marking (on random place) fischer anchor rod RG M:

Property class 8.8: + or colour coding acc. to DIN 976-1:2016

Installation conditions:

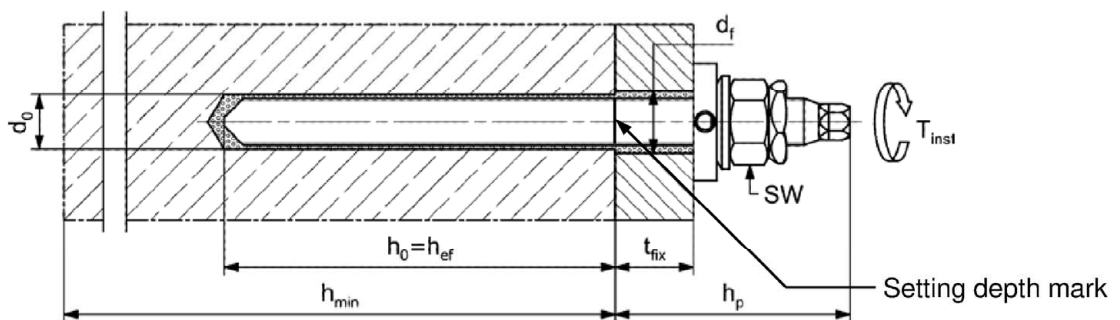

Figures not to scale

fischer Superbond dynamic

Intended use

Installation parameters fischer anchor rod RG M in combination with resin capsule system RSB

Annex B 6

Appendix 12 / 26

Table B7.1: Dimension of resin capsule RSB

Resin capsule RSB		12 mini	12	16 mini	16	20	20 E / 24
Capsule diameter	d_p	12,5		16,5		23,0	
Capsule length	L_p	72	97	72	95	160	190

**Table B7.2:** Assignment of resin capsule RSB to fischer anchor rod RG M

Anchor rod RG M		M12	M16	M20	M24
Effective anchorage depth	$h_{ef,1}$ [mm]	75	95	---	---
Related capsule RSB	[-]	12 mini	16 mini	---	---
Effective anchorage depth	$h_{ef,2}$ [mm]	110	125	170	210
Related capsule RSB	[-]	12	16	20	20 E / 24
Effective anchorage depth	$h_{ef,3}$ [mm]	150	190	210	---
Related capsule RSB	[-]	2x 12 mini	2x 16 mini	20 E / 24	---

Table B7.3: Parameters of the cleaning brush BS (steel brush with steel bristles)

The size of the cleaning brush refers to the drill hole diameter

Nominal drill hole diameter	d_0	14	18	24	25	28
Steel brush diameter	d_b	16	20	26	27	30

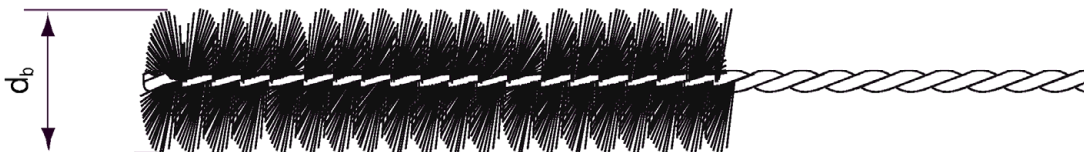

fischer Superbond dynamic

Intended use

Dimensions of the capsules; Assignment of the capsule to the anchor rod RG M;
Cleaning brush (steel brush)

Annex B 7

Appendix 13 / 26

Table B8.1: Maximum processing time of the mortar and minimum curing time

During the curing time of the mortar the concrete temperature may not fall below the listed minimum temperature. Minimal cartridge temperature +5 °C; minimal resin capsule temperature -15 °C

Temperature at anchoring base [°C]	Maximum processing time t_{work}		Minimum curing time t_{cure}		
	FIS SB	FIS SB High Speed	FIS SB	FIS SB High Speed	RSB
-30 to -20	---	---	---	---	120 h
> -20 to -15	---	60 min	---	24 h	48 h
> -15 to -10	60 min	30 min	36 h	8 h	30 h
> -10 to -5	30 min	15 min	24 h	3 h	16 h
> -5 to 0	20 min	10 min	8 h	2 h	10 h
> 0 to 5	13 min	5 min	4 h	1 h	45 min
> 5 to 10	9 min	3 min	2 h	45 min	30 min
> 10 to 20	5 min	2 min	1 h	30 min	20 min
> 20 to 30	4 min	1 min	45 min	15 min	5 min
> 30 to 40	2 min	---	30 min	---	3 min

fischer Superbond dynamic

Intended use
Processing time and curing time

Annex B 8

Appendix 14 / 26

Installation instructions part 1; injection mortar system FIS SB

Drilling and cleaning the hole (hammer drilling with standard drill bit)

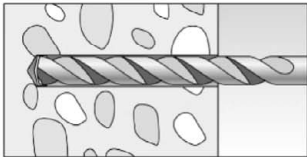
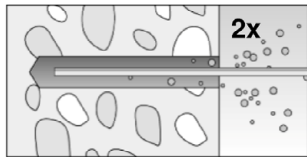
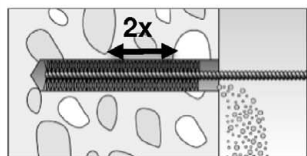
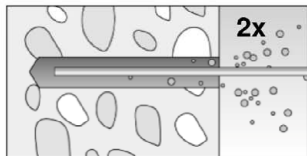
1		<p>Drill the hole. Nominal drill hole diameter d_0 and drill hole depth h_0 see table B4.1</p>
2		<p>Clean the drill hole: Blow out the drill hole twice, with oil free compressed air ($p \geq 6$ bar)</p> <p>In uncracked concrete the use of the manual blow-out pump ABG is possible (Installation parameters: $d_0 < 18$ mm and $h_{ef} < 10d$)</p>
3		<p>Brush the drill hole twice. For deep holes use an extension. Corresponding brushes see table B7.3</p>
4		<p>Clean the drill hole: Blow out the drill hole twice, with oil free compressed air ($p \geq 6$ bar)</p> <p>In uncracked concrete the use of the manual blow-out pump ABG is possible (Installation parameters: $d_0 < 18$ mm and $h_{ef} < 10d$)</p>

Go to step 5 (Annex B 10)

Drilling and cleaning the hole (hammer drilling with hollow drill bit)

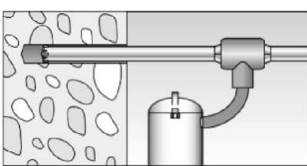
1		<p>Check a suitable hollow drill (see table B1.1) for correct operation of the dust extraction</p>
2		<p>Use a suitable dust extraction system, e.g. fischer FVC 35 M or a comparable dust extraction system with equivalent performance data.</p> <p>Drill the hole with hollow drill bit. The dust extraction system has to extract the drill dust nonstop during the drilling process and must be adjusted to maximum power. Nominal drill hole diameter d_0 and drill hole depth h_0 see table B4.1</p>

Go to step 5 (Annex B 10)

fischer Superbond dynamic





Intended use
Installation instructions part 1; injection mortar system FIS SB

Annex B 9

Appendix 15 / 26

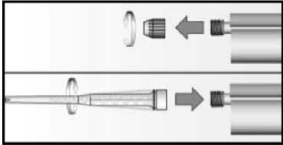
Installation instructions part 2; injection mortar system FIS SB

Preparing the cartridge

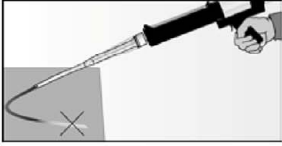
5		Remove the sealing cap Screw on the static mixer (the spiral in the static mixer must be clearly visible)	
6			Place the cartridge into the dispenser
7			Extrude approximately 10 cm of material out until the resin is evenly grey in colour. Do not use mortar that is not uniformly grey

Go to step 8 (pre-positioned installation Annex B 11 or push through installation Annex B 12)

fischer Superbond dynamic



Intended use
Installation instructions part 2; injection mortar system FIS SB

Annex B 10

Appendix 16 / 26

Installation instructions part 3, injection mortar system FIS SB

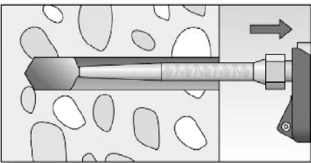
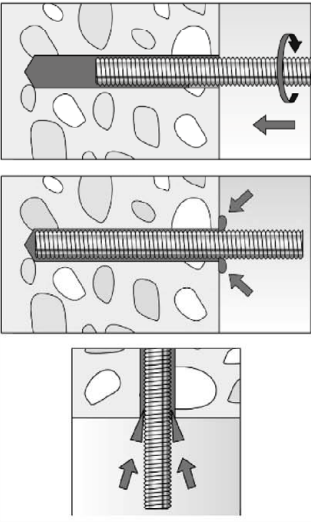
Pre-positioned installation

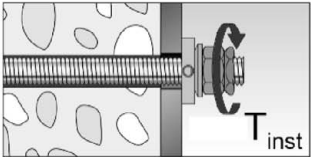
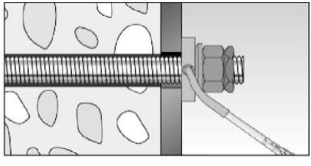
8		<p>Fill approximately 2/3 of the drill hole with mortar. Always begin from the bottom of the hole and avoid bubbles. For drill hole depth ≥ 150 mm use an extension tube. For overhead installation, deep holes $h_0 > 250$ mm use an injection adapter.</p>
9		<p>Only use clean and oil-free metal parts. Mark the setting depth of the anchor rod. Push the Fischer anchor rod down to the bottom of the hole, turning it slightly while doing so.</p> <p>After inserting the anchor rod, excess mortar must be emerged around the anchor element. If not, pull out the anchor element immediately and reinject mortar.</p> <p>For overhead installations support the anchor rod with wedges (e.g. Fischer centering wedges) until the mortar begins to harden.</p>
10		<p>Wait for the specified curing time t_{cure} see table B8.1</p>
11		<p>Attach the component and install the washer and nuts - without centering sleeve. Tighten the hexagon nut with torque wrench, T_{inst} see table B4.1. Tighten lock nut manually, then use wrench to give another quarter or half turn.</p>
12		<p>The gap between anchor and fixture (annular clearance) has to be filled with mortar (FIS SB or FIS SB High Speed) via the fillable conical washer. If only tension loads are involved in the application, the annular gap does not necessarily have to be filled.</p>

fischer Superbond dynamic

Intended use

Installation instructions part 3; pre-positioned installation; injection mortar system FIS SB

Annex B 11

Appendix 17 / 26

Installation instructions part 4, injection mortar system FIS SB

Push through installation

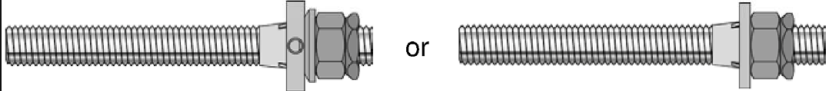
8		<p>Pre-assemble the anchor! (Position of the conical washer or washer = embedment depth + fixture thickness)</p>
---	---	---

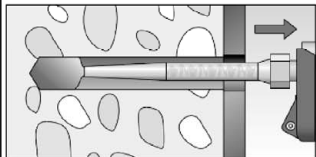
9		<p>Fill approximately 2/3 of the drill hole incl. fixture with mortar. Always begin from the bottom of the hole and avoid bubbles. For drill hole depth ≥ 150 mm use an extension tube. For overhead installation, deep holes $h_0 > 250$ mm use an injection adapter.</p>
---	---	---

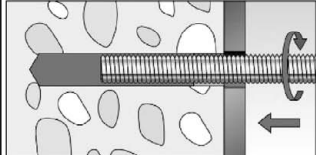
10		<p>Only use clean and oil-free metal parts. Push the pre-assembled fischer anchor rod into the drill hole until the conical washer or washer is in full contact with the surface, turning it slightly while doing so.</p>
----	---	--

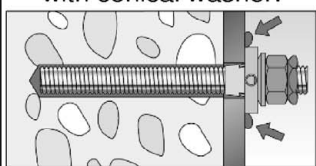
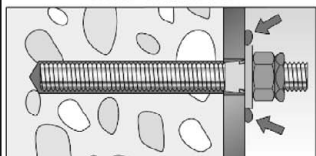
10	<p>with conical washer:</p> 	<p>After inserting the anchor rod with pre-assembled components, excess mortar must be emerged around the anchor element (minimum on one point of the conical washer or washer). If not, pull out the anchor element immediately and reinject mortar.</p>
10	<p>with washer:</p> 	

11		<p>Wait for the specified curing time t_{cure} see table B8.1</p>
----	---	--

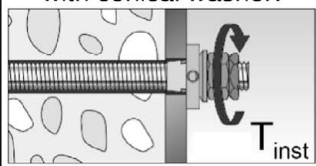
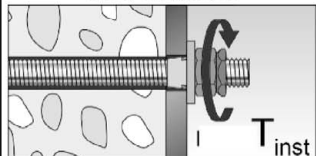
12	<p>with conical washer:</p> 	<p>Tighten the hexagon nut with torque wrench, T_{inst} see table B4.1. Tighten lock nut manually, then use wrench to give another quarter or half turn.</p>
12	<p>with washer:</p> 	



fischer Superbond dynamic

Intended use
 Installation instructions part 4; push through installation; injection mortar system FIS SB

Annex B 12
 Appendix 18 / 26

Installation instructions part 5; resin capsule RSB

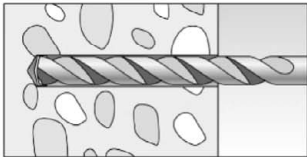
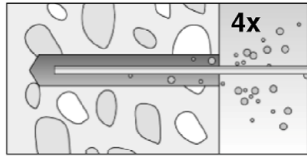
Drilling and cleaning the hole (hammer drilling with standard drill bit)

1		<p>Drill the hole. Nominal drill hole diameter d_0 and drill hole depth h_0 see table B6.1</p>	
2		<p>Clean the drill hole: Blow out the drill hole four times, with oil free compressed air ($p \geq 6$ bar)</p> <p>In uncracked concrete the use of the manual blow-out pump ABG is possible (Installation parameters: $d_0 < 18$ mm and $h_{ef} < 10d$)</p>	

Go to step 6 (pre-positioned installation Annex B 15 or push through installation Annex B 16)

Drilling and cleaning the hole (hammer drilling with hollow drill bit)

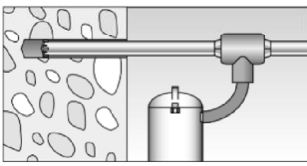
1		<p>Check a suitable hollow drill (see table B2.1) for correct operation of the dust extraction</p>	
2		<p>Use a suitable dust extraction system, e.g. fischer FVC 35 M or a comparable dust extraction system with equivalent performance data.</p> <p>Drill the hole with hollow drill bit. The dust extraction system has to extract the drill dust nonstop during the drilling process and must be adjusted to maximum power. Nominal drill hole diameter d_0 and drill hole depth h_0 see table B6.1</p>	

Go to step 6 (pre-positioned installation Annex B 15 or push through installation Annex B 16)

fischer Superbond dynamic

Intended use
Installation instructions part 5; resin capsule RSB

Annex B 13

Appendix 19 / 26

Installation instructions part 6; resin capsule RSB

Drilling and cleaning the hole (wet drilling with diamond drill bit)

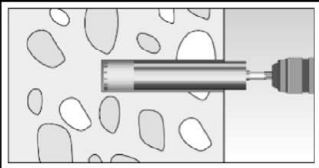
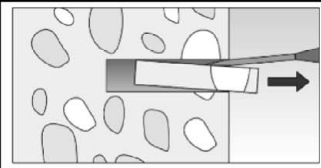
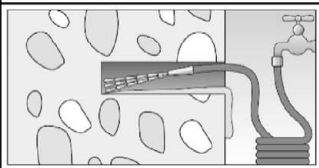
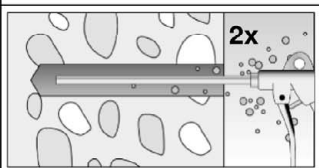
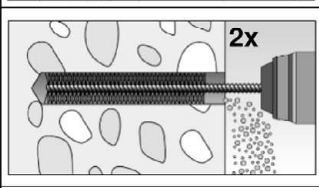
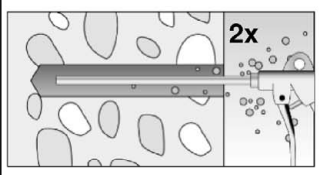
1		Drill the hole. Drill hole diameter d_0 and nominal drill hole depth h_0 see table B6.1	 Break the drill core and remove it
2		Flush the drill hole, until clear water emerges from the drill hole.	
3	 2x	Blow out the drill hole twice, using oil-free compressed air ($p > 6$ bar)	
4	 2x	Brush the drill hole twice using a power drill. Corresponding brushes see table B7.3	
5	 2x	Blow out the drill hole twice, using oil-free compressed air ($p > 6$ bar)	

Go to step 6 (pre-positioned installation Annex B 15 or push through installation Annex B 16)

fischer Superbond dynamic



Intended use
Installation instructions part 6; resin capsule RSB

Annex B 14

Appendix 20 / 26

Installation instructions part 7; resin capsule RSB

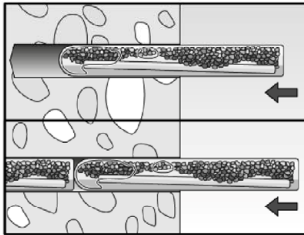
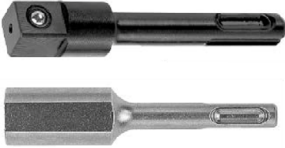
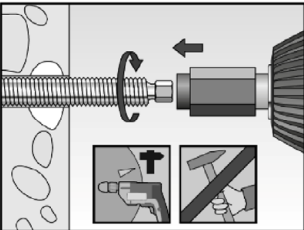
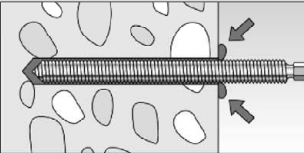
Pre-positioned installation fischer anchor rod RG M

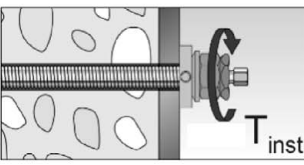
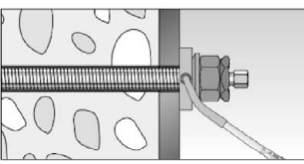
6		<p>Insert the resin capsule into the drill hole by hand. Suitable resin capsule RSB or RSB mini see table B7.2.</p>	 <p>Depending on the metal part, use a suitable setting tool / adapter</p>
7		<p>Only use clean and grease-free metal parts. Drive the fischer anchor rod RG M into the capsule using suitable adapter and hammer drill set on rotary hammer action. Stop when the metal part reaches the bottom of the hole and the correct embedment depth is reached.</p>	
8		<p>When the correct embedment depth is reached, excess mortar must emerge from the mouth of the drill hole. If not, the metal part must be pulled out directly and another resin capsule must be pushed into the drill hole. Setting process (Step 7) must be repeated</p>	
9		<p>Wait for the specified curing time t_{cure} see table B8.1</p>	
10		<p>Attach the component and install the washer and nuts - without centering sleeve. Tighten the hexagon nut with torque wrench, T_{inst} see table B6.1. Tighten lock nut manually, then use wrench to give another quarter or half turn.</p>	
11		<p>The gap between anchor and fixture (annular clearance) has to be filled with mortar (FIS SB or FIS SB High Speed) via the fillable conical washer. If only tension loads are involved in the application, the annular gap does not necessarily have to be filled.</p>	

fischer Superbond dynamic

Intended use



Installation instructions part 7; resin capsule RSB, pre-positioned installation

Annex B 15

Appendix 21 / 26

Installation instructions part 8; resin capsule RSB

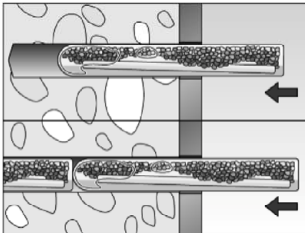
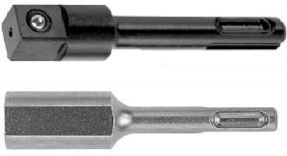
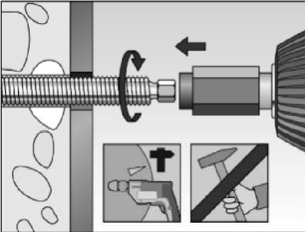
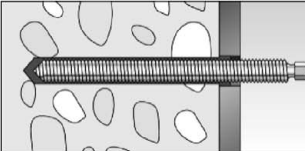
Push through installation fischer anchor rod RG M

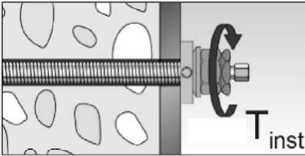
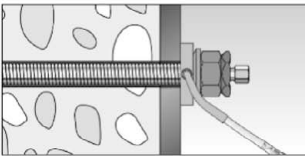
6		<p>Insert the resin capsule through the fixture into the drill hole by hand. Suitable resin capsule RSB or RSB mini see table B7.2.</p>	 <p>Depending on the metal part, use a suitable setting tool / adapter</p>
7		<p>Only use clean and grease-free metal parts. Drive the fischer anchor rod RG M into the capsule using suitable adapter and hammer drill set on rotary hammer action. Stop when the metal part reaches the bottom of the hole and the correct embedment depth is reached.</p>	
8		<p>When the correct embedment depth is reached, excess mortar must be visible in the mounting part. If not, the metal part must be pulled out directly and another resin capsule must be pushed into the drill hole. Setting process (Step 7) must be repeated</p>	
9		<p>Wait for the specified curing time t_{cure} see table B8.1</p>	
10		<p>Install the washer and nuts - without centering sleeve. Tighten the hexagon nut with torque wrench, T_{inst} see table B6.1. Tighten lock nut manually, then use wrench to give another quarter or half turn.</p>	
11		<p>The gap between anchor and fixture (annular clearance) has to be filled with mortar (FIS SB or FIS SB High Speed) via the fillable conical washer. If only tension loads are involved in the application, the annular gap does not necessarily have to be filled.</p>	

fischer Superbond dynamic

Intended use

Installation instructions part 8; resin capsule RSB, push through installation

Annex B 16

Appendix 22 / 26

Table C1.1: Essential characteristics under tension fatigue load for FIS SB / RSB; Design method I according to TR 061				
Required evidence				
Number of load cycles (n)				
$n \leq 10^4$	$10^4 < n \leq 5 \cdot 10^6$	$5 \cdot 10^6 < n \leq 10^8$	$n > 10^8$	
Tension load capacity				
Characteristic steel fatigue resistance (zinc plated steel 8.8)				
$\Delta N_{Rk,s,0,n}$ (8.8) [kN]				
$0,75 \cdot N_{Rk,s,(8.8)} \cdot 0,33$	$0,75 \cdot N_{Rk,s,(8.8)} \cdot 10^{(-0,12 \cdot \log(n))} \leq 0,75 \cdot N_{Rk,s,(8.8)} \cdot 0,33$	$0,75 \cdot N_{Rk,s,(8.8)} \cdot 10^{(-0,438 - 0,057 \cdot \log(n))}$	$0,75 \cdot N_{Rk,s,(8.8)} \cdot 0,12$	
Characteristic steel fatigue resistance (stainless steel R, property class 70)				
$\Delta N_{Rk,s,0,n}$ (R-70) [kN]				
$0,75 \cdot N_{Rk,s,(R-70)} \cdot 0,33$	$0,75 \cdot N_{Rk,s,(R-70)} \cdot 10^{(-0,16 - 0,09 \cdot \log(n))}$	$0,75 \cdot N_{Rk,s,(R-70)} \cdot 10^{(-0,469 - 0,043 \cdot \log(n))}$	$0,75 \cdot N_{Rk,s,(R-70)} \cdot 0,15$	
Characteristic combined pull-out fatigue resistance, concrete failure and pull out, in uncracked and cracked concrete				
Characteristic bond strength in uncracked concrete				
$\Delta \tau_{Rk,p,ucr,0,n}$ [N/mm ²]				
$\tau_{Rk,ucr} \cdot 0,575$	$\tau_{Rk,ucr} \cdot 10^{(-0,06 \cdot \log(n))}$	$\tau_{Rk,ucr} \cdot 10^{(-0,207 - 0,029 \cdot \log(n))}$	$\tau_{Rk,ucr} \cdot 0,35$	
Characteristic bond strength in cracked concrete				
$\Delta \tau_{Rk,p,cr,0,n}$ [N/mm ²]				
$\tau_{Rk,cr} \cdot 0,575$	$\tau_{Rk,cr} \cdot 10^{(-0,06 \cdot \log(n))}$	$\tau_{Rk,cr} \cdot 10^{(-0,207 - 0,029 \cdot \log(n))}$	$\tau_{Rk,cr} \cdot 0,35$	
Characteristic fatigue resistance for concrete cone and concrete splitting				
Characteristic concrete fatigue resistance in uncracked concrete				
$\Delta N_{Rk,c/sp,ucr,0,n}$ [kN]				
$N_{Rk,c/sp,ucr} \cdot 0,66$	$N_{Rk,c/sp,ucr} \cdot 1,1 \cdot n^{-0,055} \geq N_{Rk,c/sp,ucr} \cdot 0,50$			$N_{Rk,c/sp,ucr} \cdot 0,50$
Characteristic concrete fatigue resistance in cracked concrete				
$\Delta N_{Rk,c/sp,cr,0,n}$ [kN]				
$N_{Rk,c/sp,cr} \cdot 0,66$	$N_{Rk,c/sp,cr} \cdot 1,1 \cdot n^{-0,055} \geq N_{Rk,c/sp,cr} \cdot 0,50$			$N_{Rk,c/sp,cr} \cdot 0,50$
Exponents and load-transfer factor				
Exponent for combined load				
	M12	M16	M20	M24
$\alpha_s = \alpha_{sn}$ [-]	0,5		0,7	
Load-transfer factor				
ψ_{FN} [-]	0,5			
$N_{Rk,s}, \tau_{Rk,ucr}, \tau_{Rk,cr}$ see ETA-12/0258:2020, for τ_{Rk} (M24-R-70) $\leq 0,85 \cdot \tau_{Rk}$ (M20-R-70)				
$N_{Rk,c/sp,ucr}, N_{Rk,c/sp,cr}$ see ETA-12/0258:2020 or EN 1992-4:2018				
fischer Superbond dynamic				Annex C 1 Appendix 23 / 26
Performance Essential characteristic under tension fatigue load; Design method I according to TR 061				

Table C2.1: Essential characteristic under shear fatigue load for FIS SB / RSB; Design method I according to TR 061				
Required evidence				
Number of load cycles (n)				
$n \leq 10^4$	$10^4 < n \leq 5 \cdot 10^6$	$5 \cdot 10^6 < n \leq 10^8$	$n > 10^8$	
Shear load capacity				
Characteristic steel fatigue resistance (zinc plated steel 8.8)				
$\Delta V_{Rk,s,0,n} (8.8) [kN]$				
$V_{Rk,s,(8.8)} \cdot 0,23$	$V_{Rk,s,(8.8)} \cdot 10^{(-0,147 \cdot \log(n))} \leq V_{Rk,s,(8.8)} \cdot 0,23$	$V_{Rk,s,(8.8)} \cdot 10^{(-0,573-0,068 \cdot \log(n))} \geq V_{Rk,s,(8.8)} \cdot 0,08$	$V_{Rk,s,(8.8)} \cdot 0,08$	
Characteristic steel fatigue resistance (stainless steel R, property class 70)				
$\Delta V_{Rk,s,0,n} (R-70) [kN]$				
$V_{Rk,s,(R-70)} \cdot 0,31$	$V_{Rk,s,(R-70)} \cdot 10^{(-0,042-0,118 \cdot \log(n))}$	$V_{Rk,s,(R-70)} \cdot 10^{(-0,461-0,056 \cdot \log(n))}$	$V_{Rk,s,(R-70)} \cdot 0,12$	
Characteristic concrete pry out fatigue resistance in cracked and uncracked concrete				
$\Delta V_{Rk,cp,0,n} [kN]$				
$V_{Rk,cp} \cdot 0,574$	$V_{Rk,cp} \cdot 1,2 \cdot n^{-0,08} \geq V_{Rk,cp} \cdot 0,50$			$V_{Rk,cp} \cdot 0,50$
Characteristic concrete edge fatigue resistance in cracked and uncracked concrete				
$\Delta V_{Rk,c,0,n} [kN]$				
$V_{Rk,c} \cdot 0,574$	$V_{Rk,c} \cdot 1,2 \cdot n^{-0,08} \geq V_{Rk,c} \cdot 0,50$			$V_{Rk,c} \cdot 0,50$
Exponents, load-transfer factor				
Exponent for combined load, steel failure				
	M12	M16	M20	M24
$\alpha_s = \alpha_{sn}$	[-]	0,5	0,7	
Exponent for combined load, verification regarding failure modes other than steel failure				
α_c	[-]	1,5		
Load-transfer factor				
ψ/FV	[-]	0,5		
$V_{Rk,s}$ see ETA-12/0258:2020				
$V_{Rk,c}, V_{Rk,cp}$ see ETA-12/0258:2020 or EN 1992-4:2018				
fischer Superbond dynamic				Annex C 2 Appendix 24 / 26
Performance Essential characteristic under shear fatigue load; Design method I according to TR 061				

Table C3.1: Essential characteristics under tension and shear fatigue load;
Design method II according to TR061; zinc plated steel 8.8

Size		M12	M16
Tension load			
Effective embedment depth	$h_{ef,min}$ [mm]	95	125
Steel failure			
Characteristic steel fatigue resistance	$\Delta N_{RK,s,0,\infty}$ [kN]	6,1	11,3
Exponent for combined load	$\alpha_s = \alpha_{sn}$ [-]	0,5	0,7
Characteristic fatigue resistance combined failure, concrete failure and pull out, in uncracked and cracked concrete			
Characteristic bond resistance	$\Delta \tau_{RK,p,ucr,0,\infty}$ [N/mm ²]	$\tau_{RK,ucr} \cdot 0,35$	
	$\Delta \tau_{RK,p,cr,0,\infty}$ [N/mm ²]	$\tau_{RK,cr} \cdot 0,35$	
Concrete failure			
Characteristic concrete fatigue resistance	$\Delta N_{RK,c,0,\infty}$ [-]	$0,5 \cdot N_{RK,c}^{1)}$	
	$\Delta N_{RK,sp,0,\infty}$ [-]	$0,5 \cdot N_{RK,sp}^{1)}$	
Exponent for combined load	α_c [-]	1,5	
Load-transfer factor	ψ_{FN} [-]	0,5	
Shear load			
Shear load capacity, steel failure without lever arm			
Characteristic steel fatigue resistance	$\Delta V_{RK,s,0,\infty}$ [kN]	2,7	5,0
Exponent for combined load	$\alpha_s = \alpha_{sn}$	0,5	0,7
Concrete pryout failure			
Characteristic concrete fatigue resistance	$\Delta V_{RK,cp,0,\infty}$ [kN]	$0,5 \cdot V_{RK,cp}^{1)}$	
Concrete edge failure			
Characteristic concrete fatigue resistance	$\Delta V_{RK,c,0,\infty}$ [kN]	$0,5 \cdot V_{RK,c}^{1)}$	
The value of h_{ef} (=l _f) under shear load	l_f [mm]	≥ 95	≥ 125
Effective outside diameter of the anchor	d_{nom} [mm]	12	16
Exponent for combined load	α_c	1,5	
Load-transfer factor	ψ_{FV} [-]	0,5	

¹⁾ $N_{RK,c}$, $N_{RK,sp}$, $V_{RK,c}$ and $V_{RK,cp}$ – Essential characteristics for concrete failure under static and quasi static load according to ETA-12/0258:2020 or EN 1992-4:2018.

fischer Superbond dynamic

Performance

Essential characteristics under tension / shear fatigue load;
 Design method II according to TR 061; zinc plated steel 8.8

Annex C 3

Appendix 25 / 26

Table C4.1: Essential characteristics under tension and shear fatigue load;
Design method II according to TR061; stainless steel R property class 70

Size		M12	M16	M20	M24
Tension load					
Effective embedment depth	$h_{ef,min}$ [mm]	95	125	170	220
Steel failure					
Characteristic steel fatigue resistance	$\Delta N_{RK,s,0,\infty}$ [kN]	6,6	12,4	19,4	27,8
Exponent for combined load	$\alpha_s = \alpha_{sn}$ [-]	0,5	0,7		
Characteristic fatigue resistance combined failure, concrete failure and pull out, in uncracked and cracked concrete					
Characteristic bond resistance	$\Delta \tau_{RK,p,ucr,0,\infty}$ [N/mm ²]	$\tau_{RK,ucr} \cdot 0,35$			
	$\Delta \tau_{RK,p,cr,0,\infty}$ [N/mm ²]	$\tau_{RK,cr} \cdot 0,35$			
Concrete failure					
Characteristic concrete fatigue resistance	$\Delta N_{RK,c,0,\infty}$ [-]	$0,5 \cdot N_{RK,c}^{1)}$			
	$\Delta N_{RK,sp,0,\infty}$ [-]	$0,5 \cdot N_{RK,sp}^{1)}$			
Exponent for combined load	α_c [-]	1,5			
Load-transfer factor	ψ_{FN} [-]	0,5			
Shear load					
Shear load capacity, steel failure without lever arm					
Characteristic steel fatigue resistance	$\Delta V_{RK,s,0,\infty}$ [kN]	3,6	6,6	10,3	14,9
Exponent for combined load	$\alpha_s = \alpha_{sn}$	0,5	0,7		
Concrete pryout failure					
Characteristic concrete fatigue resistance	$\Delta V_{RK,cp,0,\infty}$ [kN]	$0,5 \cdot V_{RK,cp}^{1)}$			
Concrete edge failure					
Characteristic concrete fatigue resistance	$\Delta V_{RK,c,0,\infty}$ [kN]	$0,5 \cdot V_{RK,c}^{1)}$			
The value of h_{ef} (=l _f) under shear load	l_f [mm]	≥ 95	≥ 125	≥ 160	≥ 190
Effective outside diameter of the anchor	d_{nom} [mm]	12	16	20	24
Exponent for combined load	α_c	1,5			
Load-transfer factor	ψ_{FV} [-]	0,5			

¹⁾ $N_{RK,c}$, $N_{RK,sp}$, $V_{RK,c}$ and $V_{RK,cp}$ – Essential characteristics for concrete failure under static and quasi static load according to ETA-12/0258:2020 or EN 1992-4:2018, for τ_{RK} (M24-R-70) ≤ 0,85 · τ_{RK} (M20-R-70)

fischer Superbond dynamic

Performance

Essential characteristics under tension / shear fatigue load;
 Design method II according to TR 061; stainless steel R property class 70

Annex C 4

Appendix 26 / 26