



## DECLARAȚIA DE PERFORMANȚĂ

### DoP 0240

pentru sistem de injecție fischer FIS V Zero (Mortar pentru conexiuni de armare postinstalate)

RO

- Cod unic de identificare al produsului-tip: DoP 0240
- Utilizare (utilizări) preconizată (preconizate): Sistem pentru conectarea armăturilor post-instalate cu mortar pentru utilizare în beton., Consultați suplimentul, în special anexele B1 - B12.
- Fabricant: fischerwerke GmbH & Co. KG, Otto-Hahn-Straße 15, 79211 Denzlingen, Germany
- Reprezentant autorizat: -
- Sistemul (sistemele) de evaluare și de verificare a constantei performanței: 1
- Documentul de evaluare european: EAD 330087-00-0601, Edition 05/2018  
Evaluarea tehnică europeană: ETA-20/0574; 2021-05-04  
Organismul de evaluare tehnică: DIBt- Deutsches Institut für Bautechnik  
Organism (organisme) notificat(e): 2873 TU Darmstadt
- Performanța (performanțe) declarată (declarate):  
**Rezistență mecanică și stabilitate (BWR 1)**  
**Rezistența caracteristică la întindere (pentru încărcări statice și cvasistatice):**  
Aderența pentru armături post-instalate: Anexa C2  
Factor de reducere: Anexa C1  
Factor de amplificare pentru lungimea minimă de ancorare: Anexa C1  
  
**Siguranța în caz de incendiu (BWR 2)**  
Reacție la foc: Clasa (A1)  
  
**Rezistența la incendiu:**  
Aderența la temperatură ridicată: Anexa C3
- Documentație tehnică adecvată și/sau documentație tehnică specifică: -

Performanța produsului identificat mai sus este în conformitate cu setul de performanțe declarate. Această declarație de performanță este eliberată în conformitate cu Regulamentul (UE) nr. 305/2011, pe răspunderea exclusivă a fabricantului identificat mai sus.

Semnată pentru și în numele fabricantului de către:

Dr.-Ing. Oliver Geibig, Director Executiv Departament Business & Inginerie  
Tumlingen, 2021-05-11

Jürgen Grün, Director Executiv Departament Chimic & Calitate

Această declarație de performanță a fost întocmită în mai multe limbi. În cazul unei divergențe de interpretare, versiunea în limba engleză prevalează întotdeauna.

Suplimentul include informații voluntare și complementare în limba engleză, în afara cerințelor legale (specificate neutru din punct de vedere al limbii).

## Specific Part

### 1 Technical description of the product

The subject of this European Technical Assessment is the post-installed connection, by anchoring or overlap connection joint, of reinforcing bars (rebars) in existing structures made of normal weight concrete, using the injection mortar fischer FIS V Zero in accordance with the regulations for reinforced concrete construction.

Reinforcing bars made of steel with a diameter  $\phi$  from 8 to 25 mm or the fischer rebar anchor FRA or FRA HCR of sizes M12, M16, M20 and M24 and injection mortar fischer FIS V Zero are used for the rebar connection. The steel element is placed into a drilled hole filled with injection mortar and is anchored via the bond between embedded element, injection mortar and concrete.

The product description is given in Annex A.

### 2 Specification of the intended use in accordance with the applicable European assessment Document

The performances given in Section 3 are only valid if the anchor is used in compliance with the specifications and conditions given in Annex B.

The verifications and assessment methods on which this European Technical Assessment is based lead to the assumption of a working life of the rebar connections of at least 50 years. The indications given on the working life cannot be interpreted as a guarantee given by the producer, but are to be regarded only as a means for choosing the right products in relation to the expected economically reasonable working life of the works.

### 3 Performance of the product and references to the methods used for its assessment

#### 3.1 Mechanical resistance and stability (BWR 1)

| Essential characteristic  | Performance  |
|---|--------------|
| Characteristic resistance under static and quasi-static loading | See Annex C1 |

#### 3.2 Safety in case of fire (BWR 2)

| Essential characteristic | Performance         |
|--------------------------|---------------------|
| Reaction to fire         | Class A1            |
| Resistance to fire       | See Annex C2 and C3 |

### 4 Assessment and verification of constancy of performance (AVCP) system applied, with reference to its legal base

In accordance with European Assessment Document EAD No. 330087-00-0601, the applicable European legal act is: [96/582/EC].

The system to be applied is: 1

# Installation conditions and application examples reinforcing bars, part 1

**Figure A1.1:**

Overlap joint with existing reinforcement for rebar connections of slabs and beams

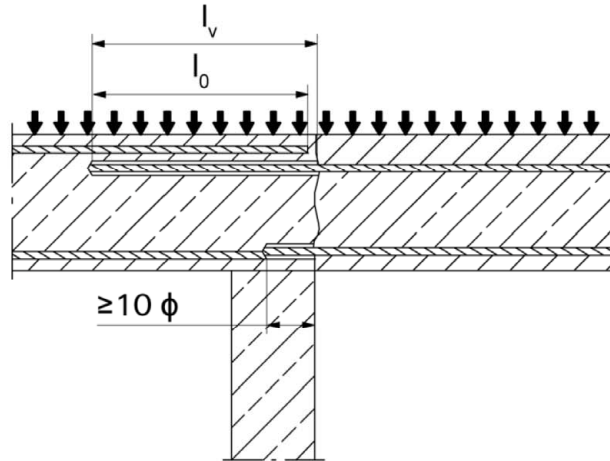

**Figure A1.2:**

Overlap joint with existing reinforcement at a foundation of a column or wall where the rebars are stressed

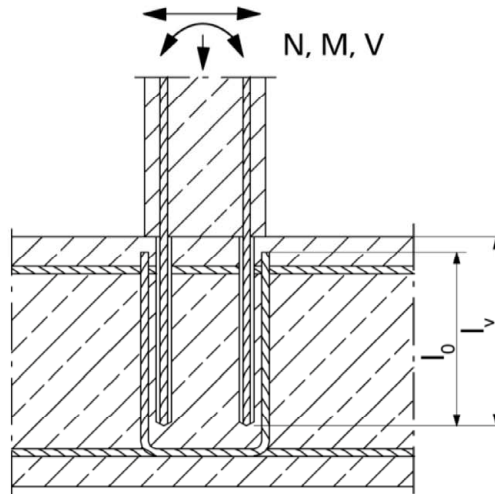

**Figure A1.3:**

End anchoring of slabs or beams (e.g. designed as simply supported)

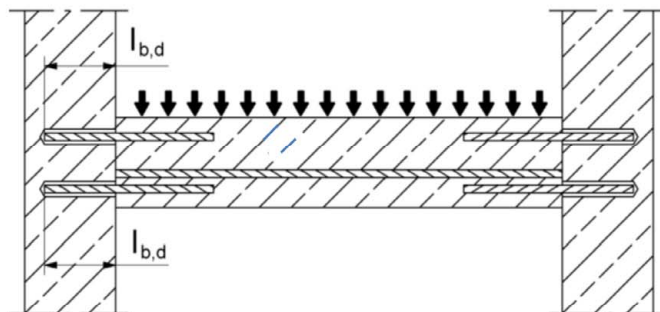

Figures not to scale

Rebar connection with fischer injection system FIS V Zero

**Product description**

Installation conditions and application examples reinforcing bars, part 1

**Annex A 1**

Appendix 2 / 22

## Installation conditions and application examples reinforcing bars, part 2

**Figure A2.1:**

Rebar connection for stressed primarily in compression

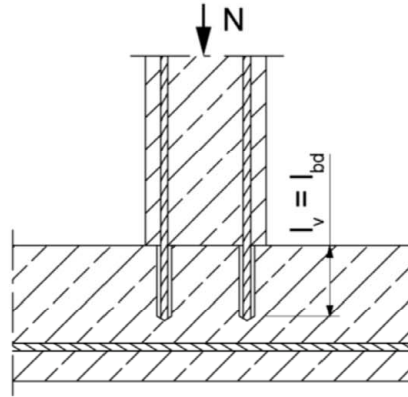

**Figure A2.2:**

Anchoring of reinforcement to cover the enveloped line of acting tensile force in the bending member

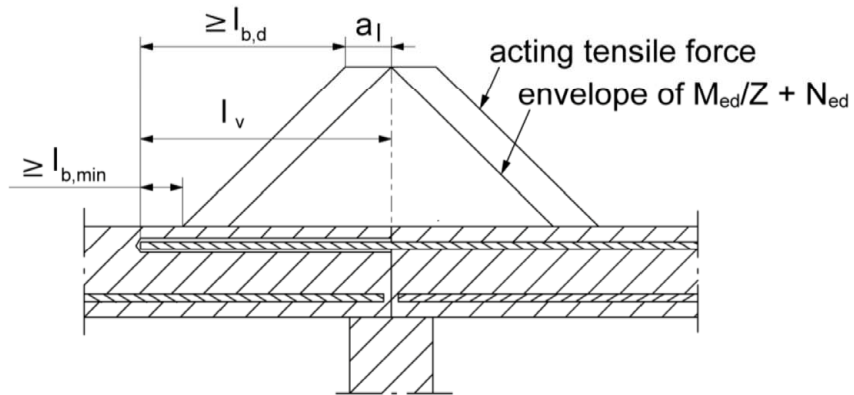

Note to **figure A1.1 to A1.3** and **figure A2.1 to A2.2**

In the figures no traverse reinforcement is plotted, the traverse reinforcement shall comply with EN 1992-1-1:2004+AC:2010

Preparing of joints according to **Annex B 2**

Figures not to scale

Rebar connection with fischer injection system FIS V Zero

**Product description**

Installation conditions and application examples reinforcing bars, part 2

**Annex A 2**

Appendix 3 / 22

# Installation conditions and application examples fischer rebar anchor

**Figure A3.1:**

Lap to a foundation of a column under bending.

1. Shear lug (or fastener loaded in shear)
2. fischer rebar tension anchor (tension only)
3. Existing stirrup / reinforcement for overlap (lap splice)
4. Slotted hole

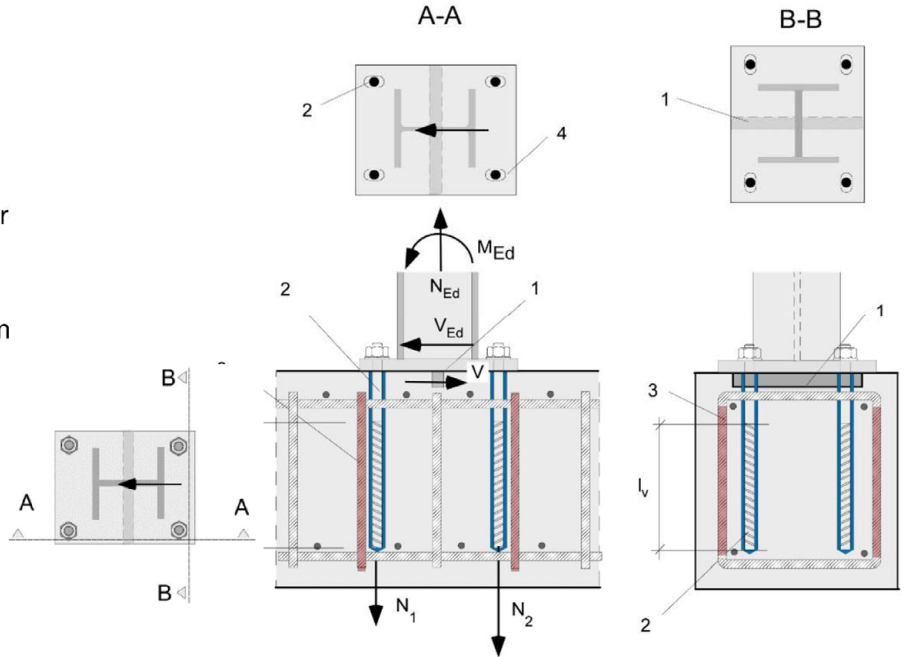
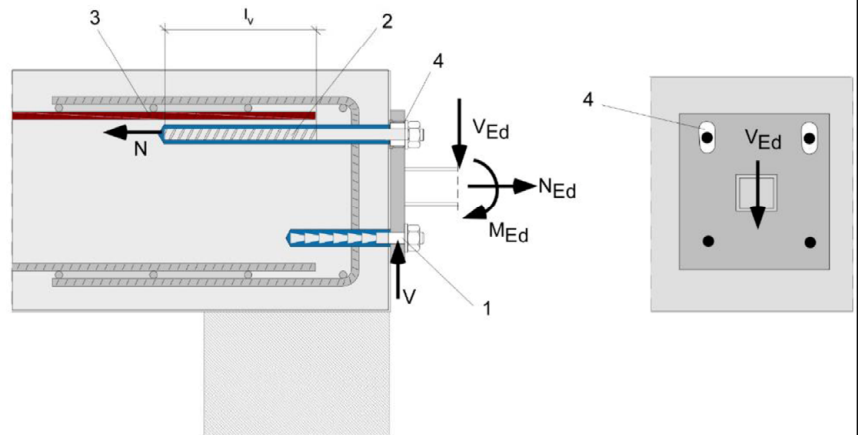

**Figure A3.2:**

Lap of the anchoring of guardrail posts or anchoring of cantilevered building components.

In the anchor plate, the drill holes for the fischer rebar anchors have to be designed as slotted holes with axial direction to the shear force.

1. Fastener for shear load transfer
2. fischer rebar tension anchor (tension only)
3. Existing stirrup / reinforcement for overlap (lap splice)
4. Slotted hole



The required transverse reinforcement acc. to EN 1992-1-1:2004+AC:2010 is not shown in the figures. **The fischer rebar anchor may be only used for axial tensile force.** The tensile force must be transferred by lap to the existing reinforcement of the building. The transfer of the shear force has to be ensured by suitable measures, e.g. by means of shear force or anchors with European Technical Assessment (ETA).

Figures not to scale

Rebar connection with fischer injection system FIS V Zero

**Product description**

Installation conditions and application examples fischer rebar anchors

**Annex A 3**

## Overview system components

**Injection cartridge (shuttle cartridge) FIS V Zero with sealing cap; Sizes: 360 ml, 825 ml**

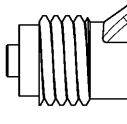
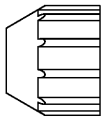

**Imprint:** fischer FIS V Zero, processing notes, shelf-life, curing times and processing times (depending on temperature), piston travel scale (optional), size, volume



**Injection cartridge (coaxial cartridge) FIS V Zero with sealing cap; Sizes: 300 ml, 380 ml, 400 ml, 410 ml**

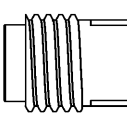
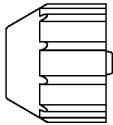

**Imprint:** fischer FIS V Zero, processing notes, shelf-life, curing times and processing times (depending on temperature), piston travel scale (optional), size, volume

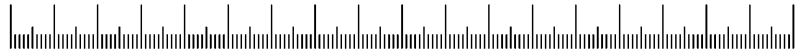

**Static mixer FIS MR Plus for injection cartridges up to 410 ml**

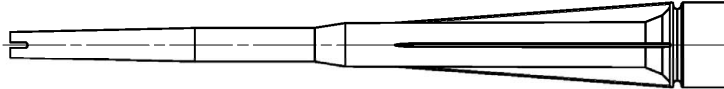

**Static mixer FIS JMR for injection cartridges 825 ml**

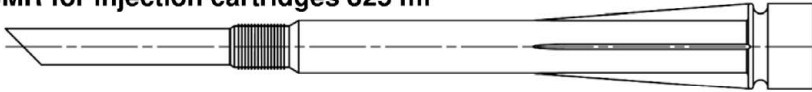

**Injection adapter and extension tube Ø 9 for static mixer FIS MR Plus;  
Injection adapter and extension tube Ø 9 or Ø 15 for static mixer FIS JMR**

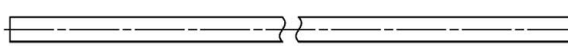
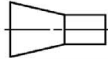

**Reinforcing bar (rebar) Sizes:  $\phi 8$ ,  $\phi 10$ ,  $\phi 12$ ,  $\phi 14$ ,  $\phi 16$ ,  $\phi 20$ ,  $\phi 22$ ,  $\phi 24$ ,  $\phi 25$**



marking setting depth

**fischer rebar anchor FRA, FRA HCR Sizes: M12, M16, M20, M24**

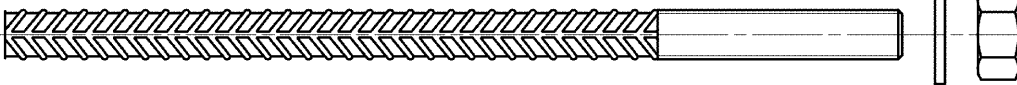

**Blow out pump ABP with cleaning nozzle:**

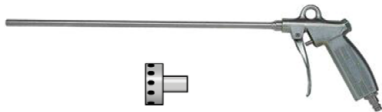

**or AB G:**



Figures not to scale

Rebar connection with fischer injection system FIS V Zero

### Product description

Overview system components: injection mortar, static mixer, injection adapter, reinforcing bar, fischer rebar anchor, blow out pump

**Annex A 4**

Appendix 5 / 22

## Properties of reinforcing bars (rebar)

Figure A5.1:



- The minimum value of related rip area  $f_{R,min}$  according to EN 1992-1-1:2004+AC:2010
- The maximum outer rebar diameter over the ribs shall be:
  - The nominal diameter of the bar with rip  $\phi + 2 * h$  ( $h \leq 0,07 * \phi$ )
  - ( $\phi$ : Nominal diameter of the bar; h: rip height of the bar)

**Table A5.1: Installation conditions for rebars**

| Nominal diameter of the bar          |           | $\phi$ | 8 <sup>1)</sup>              |    | 10 <sup>1)</sup> |    | 12 <sup>1)</sup> |              | 14 | 16 | 20 | 22 | 24 | 25 |
|--------------------------------------|-----------|--------|------------------------------|----|------------------|----|------------------|--------------|----|----|----|----|----|----|
| Nominal drill hole diameter          | $d_0$     | [mm]   | 10                           | 12 | 12               | 14 | 14               | 16           | 18 | 20 | 25 | 28 | 30 | 30 |
| Drill hole depth                     | $h_0$     |        | $h_0 = l_v$                  |    |                  |    |                  |              |    |    |    |    |    |    |
| Effective embedment depth            | $l_v$     |        | acc. to static calculation   |    |                  |    |                  |              |    |    |    |    |    |    |
| Minimum thickness of concrete member | $h_{min}$ |        | $l_v + 30$<br>( $\geq 100$ ) |    |                  |    |                  | $l_v + 2d_0$ |    |    |    |    |    |    |

<sup>1)</sup> Both drill hole diameters can be used

**Table A5.2: Materials of rebars**

| Designation  | Reinforcing bar (rebar)   |
|--|---|
| Reinforcing bar<br>EN 1992-1-1:2004+AC:2010, Annex C | Bars and de-coiled rods class B or C with<br>$f_{yk}$ and k according to NDP or NCL of EN 1992-1-1/NA<br>$f_{uk} = f_{tk} = k \cdot f_{yk}$ |

Figures not to scale

Rebar connection with fischer injection system FIS V Zero

**Product description**  
Properties and materials of reinforcing bars (rebar)

**Annex A 5**  
Appendix 6 / 22

## Properties of fischer rebar anchors

Figure A6.1:

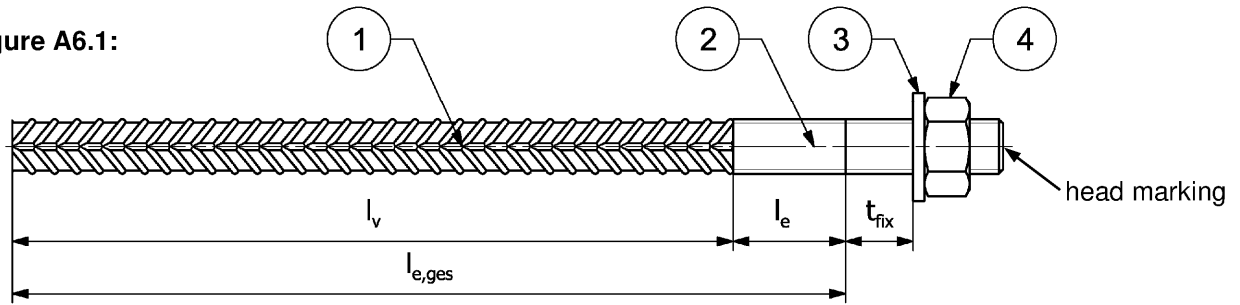

Head marking e.g.:  FRA (for stainless steel)

 FRA HCR (for high corrosion-resistant steel)

**Table A6.1: Installation conditions for fischer rebar anchors**

| Threaded diameter                                       |                                | M12 <sup>2)</sup>          |    | M16          | M20 | M24 |
|---|--------------------------------|----------------------------|----|--------------|-----|-----|
| Nominal diameter  | $\phi$ [mm]                    | 12                         |    | 16           | 20  | 25  |
| Width across flat                                       | SW [mm]                        | 19                         |    | 24           | 30  | 36  |
| Nominal drill bit diameter                              | $d_0$ [mm]                     | 14                         | 16 | 20           | 25  | 30  |
| Drill hole depth ( $h_0 = l_{e,ges}$ )                  | $l_{e,ges}$ [mm]               | $l_v + l_e$                |    |              |     |     |
| Effective embedment depth                               | $l_v$ [mm]                     | acc. to static calculation |    |              |     |     |
| Distance concrete surface to welded joint               | $l_e$ [mm]                     | 100                        |    |              |     |     |
| Diameter of clearance hole in the fixture <sup>1)</sup> | Pre-positioned $\leq d_f$ [mm] | 14                         |    | 18           | 22  | 26  |
|   | Push through $\leq d_f$ [mm]   | 16                         | 18 | 22           | 26  | 32  |
| Minimum thickness of concrete member                    | $h_{min}$ [mm]                 | $h_0+30$<br>( $\geq 100$ ) |    | $h_0 + 2d_0$ |     |     |
| Maximum torque moment for attachment of the fixture     | $\max T_{fix}$ [Nm]            | 50                         |    | 100          | 150 | 150 |

<sup>1)</sup> For bigger clearance holes in the fixture see EN 1992-4:2018

<sup>2)</sup> Both drill bit diameters can be used

**Table A6.2: Materials of fischer rebar anchors**

| Part | Description                           | Materials  |  |
|------|---------------------------------------|--|--|
|      |                                       | FRA<br>Corrosion resistance class CRC III<br>acc. to EN 1993-1-4:2015  | FRA HCR<br>Corrosion resistance class CRC V<br>acc. to EN 1993-1-4:2015                      |
| 1    | Reinforcing bar                       | Bars and de-coiled rods class B or C with $f_{yk}$ and $k$ according to NDP or NCL of EN 1992-1-1:NA; $f_{uk} = f_{tk} = k \cdot f_{yk}$ ; ( $f_{yk} = 500 \text{ N/mm}^2$ ) |  |
| 2    | Round bar with partial or full thread | Stainless steel, strength class 70 or for M 24 PC 80, according to EN 10088-1:2014   | Stainless steel, strength class 70 or for M 24 PC 80, according to EN 10088-1:2014           |
| 3    | Washer ISO 7089:2000                  | Stainless steel, according to EN 10088-1:2014  | Stainless steel, according to EN 10088-1:2014  |
| 4    | Hexagon nut                           | Stainless steel, strength class 80, acc. to EN ISO 3506-2:2009, according to EN 10088-1:2014   | Stainless steel, strength class 80, acc. to EN ISO 3506-2:2009, according to EN 10088-1:2014 |

Figures not to scale

Rebar connection with fischer injection system FIS V Zero

**Product description**

Properties and materials of fischer rebar anchors





**Annex A 6**

Appendix 7 / 22



## Specifications of intended use (part 1)

**Table B1.1:** Overview use and performance categories

| Anchorages subject to   | FIS V Zero with ...  |   |           |   |
|---|--|---|-----------|---|
|   | Reinforcing bar<br> | fischer rebar anchor<br> |           |   |
| Hammer drilling with standard drill bit or compressed air drilling<br>   | all sizes  |   |           |   |
| Hammer drilling with hollow drill bit (fischer "FHD", Heller "Duster Expert"; Bosch „Speed Clean“; Hilti "TE-CD, TE-YD")<br> | Nominal drill bit diameter ( $d_0$ )<br>12 mm to 30 mm   |   |           |   |
| Static and quasi static load, in uncracked concrete   | all sizes  | Tables:<br>C1.1<br>C1.2<br>C2.1   | all sizes | Tables:<br>C1.1<br>C1.2<br>C1.3<br>C2.1 |
| Installation temperature  | $T_{i,min} = -10\text{ °C}$ to $T_{i,max} = +40\text{ °C}$   |   |           |   |
| Resistance to fire  | all sizes  | Annex C3  | all sizes | Table C2.2                              |
|   |  |   |           |   |
| Rebar connection with fischer injection system FIS V Zero   |  |   |           | <b>Annex B 1</b><br>Appendix 8 / 22     |
| <b>Intended use</b><br>Specifications (part 1)  |  |   |           |   |

## Specifications of intended use (part 2)

### Anchorage subject to:

- Static and quasi-static loads: reinforcing bar (rebar) size 8 mm to 25 mm
- Resistance to fire

### Base materials:

- Compacted reinforced or unreinforced normal weight concrete without fibres according to EN 206:2013+A1:2016
- Strength classes C12/15 to C50/60 according to EN 206:2013+A1:2016
- Maximum chloride content of 0,40 % (CL 0.40) related to the cement content according to EN 206:2013+A1:2016
- Non-carbonated concrete

Note: In case of a carbonated surface of the existing concrete structure, the carbonated layer shall be removed in the area of the post-installed rebar connection with a diameter of  $\phi + 60$  mm prior to the installation of the new rebar. The depth of concrete to be removed shall correspond to at least the minimum concrete cover in accordance with EN 1992-1-1 :2004+AC:2010. The foregoing may be neglected if building components are new and not carbonated and if building components are in dry conditions.

### Application temperature Range:

- -40°C to +80°C (max. short term temperature +80°C and max long-term temperature +50°C).

### Installation temperature:

- -10 °C to +40 °C

### Use conditions (Environmental conditions) for fischer rebar anchors:

- For all conditions according to EN 1993-1-4:2015 corresponding to corrosion resistance classes to Annex A 6 table A6.2

### Design:

- Anchorages are designed under the responsibility of an engineer experienced in anchorages and concrete work.
- Verifiable calculation notes and drawings are prepared taking account of the forces to be transmitted.
- Design according to EN 1992-1-1:2004+AC:2010, EN 1992-1-2:2004+AC:2008 and Annex B 3 and B 4.
- The actual position of the reinforcement in the existing structure shall be determined on the basis of the construction documentation and taken into account when designing.

### Installation:

- Dry or wet concrete
- It must not be installed in water filled holes
- Hole drilling by hammer drill, hollow drill or compressed air drill mode
- Overhead installation allowed
- The installation of post-installed rebar respectively fischer rebar anchor shall be done only by suitable trained installer and under supervision on site; the conditions under which an installer may be considered as suitable trained and the conditions for Supervision on site are up to the member states in which the installation is done.
- Check the position of the existing rebars (if the position of existing rebars is not known, it shall be determined using a rebar detector suitable for this purpose as well as on the basis of the construction documentation and then marked on the building component for the overlap joint).

Rebar connection with fischer injection system FIS V Zero

**Intended use**  
Specifications (part 2)

**Annex B 2**  
Appendix 9 / 22

## General construction rules for post-installed rebars

**Figure B3.1:**

- Only tension forces in the axis of the rebar may be transmitted.
- The transfer of shear forces between new concrete and existing structure shall be designed additionally according to EN 1992-1-1:2004+AC:2010.
- The joints for concreting must be roughened to at least such an extent that aggregate protrude.

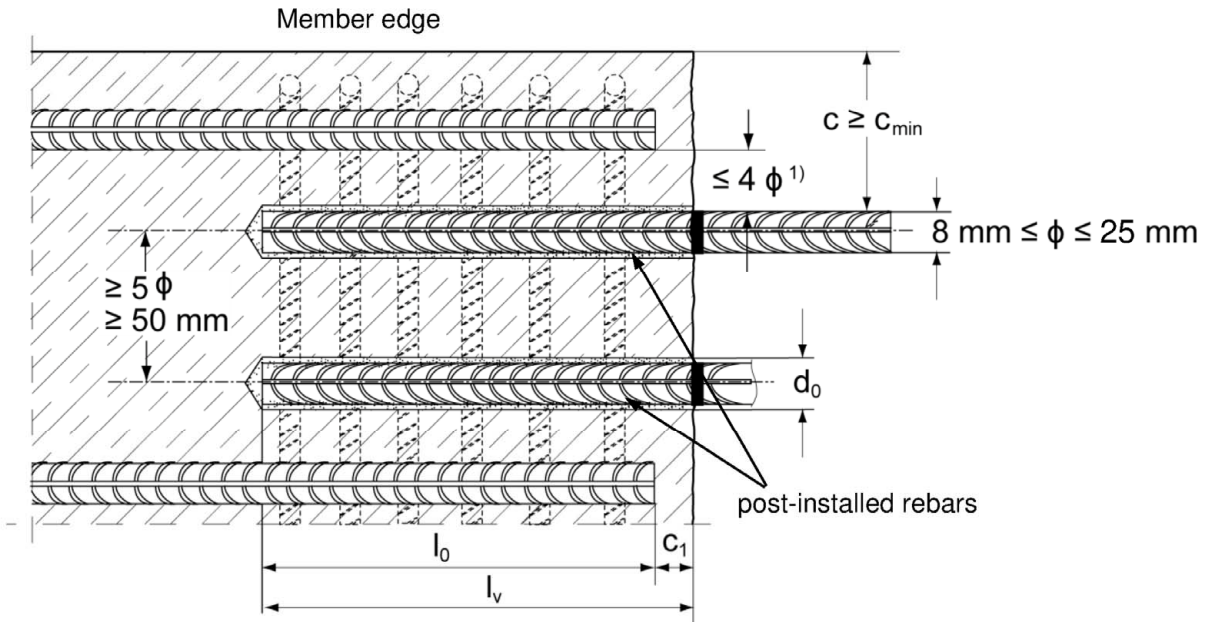

1) If the clear distance between lapped bars exceeds  $4 \phi$  then the lap length shall be increased by the difference between the clear bar distance and  $4 \phi$

- $c$  concrete cover of post-installed rebar  
 $c_1$  concrete cover at end-face of existing rebar  
 $c_{min}$  minimum concrete cover according to table B5.1 and to EN 1992-1-1:2004+AC:2010, Section 4.4.1.2  
 $\phi$  nominal diameter of reinforcing bar  
 $l_0$  lap length, according to EN 1992-1-1:2004+AC:2010  
 $l_v$  effective embedment depth,  $\geq l_0 + c_1$   
 $d_0$  nominal drill bit diameter, see Annex B 6

Figures not to scale

Rebar connection with fischer injection system FIS V Zero

**Intended use**  
 General construction rules for post-installed rebars

**Annex B 3**

Appendix 10 / 22

## General construction rules for post-installed fischer rebar anchors

Figure B4.1:

- Only tension forces in the axis of the fischer rebar anchor may be transmitted.
- The tension force must be transferred via an overlap joint to the reinforcement in the building part.
- The transmission of the shear load shall be ensured by appropriate additional measures, e.g. by shear lugs or by anchors with a European Technical Assessment (ETA).
- In the anchor plate, the holes for the tension anchor shall be executed as slotted holes with the axis in the direction of the shear force.

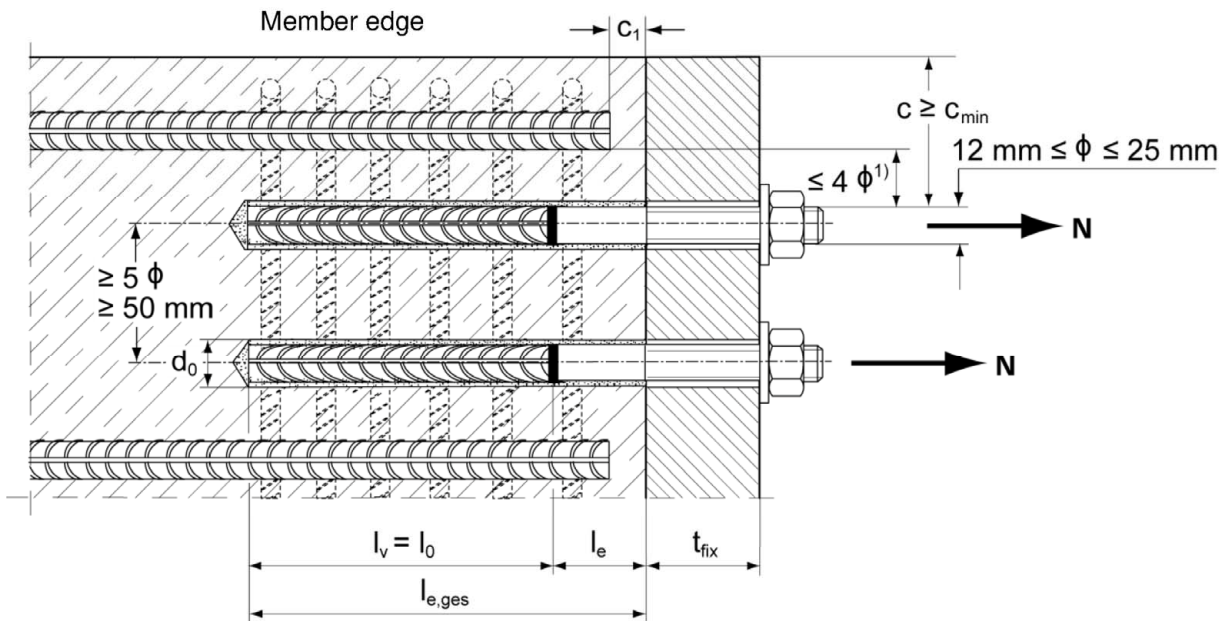

1) If the clear distance between lapped bars exceeds  $4 \phi$  then the lap length shall be increased by the difference between the clear bar distance and  $4 \phi$ .

|             |   |
|-------------|---|
| c           | concrete cover of post-installed fischer rebar anchor   |
| $c_1$       | concrete cover at end-face of existing rebar  |
| $c_{min}$   | minimum concrete cover according to table B5.1 and to EN 1992-1-1:2004+AC:2010, Section 4.4.1.2 |
| $\phi$      | nominal diameter of reinforcing bar   |
| $l_0$       | lap length, according to EN 1992-1-1:2004+AC:2010, Section 8.7.3                                |
| $l_{e,ges}$ | overall embedment depth, $\geq l_0 + l_e$   |
| $d_0$       | nominal drill bit diameter, see Annex B 6   |
| $l_e$       | length of the bonded in threaded part   |
| $t_{fix}$   | thickness of the fixture  |
| $l_v$       | effective embedment depth   |

Figures not to scale

Rebar connection with fischer injection system FIS V Zero

### Intended use

General construction rules for post-installed fischer rebar anchors

**Annex B 4**

Appendix 11 / 22

**Table B5.1: Minimum concrete cover  $c_{min}^{1)}$  depending on the drilling method and the drilling tolerance**

| Drilling method   | nominal diameter of reinforcing bar $\phi$ [mm] | Minimum concrete cover $c_{min}$ |                                |
|---|---|----------------------------------|--------------------------------|
|   |   | Without drilling aid [mm]        | With drilling aid [mm]         |
| Hammer drilling with standard drill bit or Hammer drilling with hollow drill bit (fischer "FHD", Heller "Duster Expert"; Bosch "Speed Clean"; Hilti "TE-CD, TE-YD") | < 25  | 30 mm + 0,06 $l_v \geq 2 \phi$   | 30 mm + 0,02 $l_v \geq 2 \phi$ |
|   | = 25  | 40 mm + 0,06 $l_v \geq 2 \phi$   | 40 mm + 0,02 $l_v \geq 2 \phi$ |
| Compressed air drilling   | < 25  | 50 mm + 0,08 $l_v$               | 50 mm + 0,02 $l_v$             |
|   | = 25  | 60 mm + 0,08 $l_v \geq 2 \phi$   | 60 mm + 0,02 $l_v \geq 2 \phi$ |

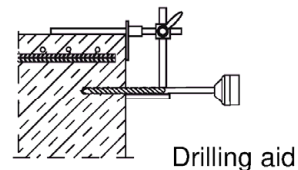

<sup>1)</sup> See Annex B 3, figure B3.1 and Annex B 4, figure B4.1

Note: The minimum concrete cover as specified in EN 1992-1-1:2004+AC:2010 must be observed.

**Table B5.2: Dispensers and cartridge sizes corresponding to maximum embedment depth  $l_{v,max}$  resp.  $l_{e,ges,max}$**

| reinforcing bars (rebar) | fischer rebar anchor   | Manual dispenser   | Pneumatic or cordless dispenser (small) | Pneumatic or cordless dispenser (large) |
|--------------------------|------------------------|--|---|---|
|                          |                        | Cartridge size $\leq 500$ ml (e.g. 300 ml, 360 ml, 380 ml, 400 ml, 410 ml) |   | Cartridge size $>500$ ml (e.g. 825 ml)  |
| $\phi$ [mm]              | [-]                    | $l_{v,max} / l_{e,ges,max}$ [mm]   |   | $l_{v,max} / l_{e,ges,max}$ [mm]        |
| 8                        | ---                    | 700  | 1000                                    | 1500                                    |
| 10                       | ---                    |  |   |   |
| 12                       | FRA M12<br>FRA HCR M12 |  |   |   |
| 14                       | ---                    |  |   |   |
| 16                       | FRA M16<br>FRA HCR M16 |  |   |   |
| 20                       | FRA M20<br>FRA HCR M20 |  |   |   |
| 22                       | ---                    |  |   |   |
| 24                       | ---                    |  |   |   |
| 25                       | FRA M24<br>FRA HCR M24 |  |   |   |

**Table B5.3: Conditions for use static mixer without an extension tube**

| Nominal drill hole diameter $d_0$ | [mm] | 10  | 12   | 14 | 16         | 18         | 20         | 22         | 24         | 25         | 28         | 30         |
|-----------------------------------|------|---|------|----|------------|------------|------------|------------|------------|------------|------------|------------|
|                                   |      | Drill hole depth $h_0$ by FIS MR Plus using FIS JMR | [mm] | -  | -          | -          | $\leq 120$ | $\leq 140$ | $\leq 150$ | $\leq 160$ | $\leq 170$ | $\leq 190$ |
|                                   |      | -   | -    | -  | $\leq 160$ | $\leq 180$ | $\leq 190$ | $\leq 210$ | $\leq 220$ | $\leq 220$ | $\leq 250$ | $\leq 250$ |

Rebar connection with fischer injection system FIS V Zero

**Intended use**  
Minimum concrete cover;  
dispenser and cartridge sizes corresponding to maximum embedment depth

**Annex B 5**

Appendix 12 / 22

**Table B6.1: Working times  $t_{work}$  and curing times  $t_{cure}$** 

| Temperature at anchoring base [°C] <sup>3)</sup> | Maximum processing time <sup>1)</sup><br>$t_{work}$ | Minimum curing time <sup>2)</sup><br>$t_{cure}$ |
|--|---|---|
|  | FIS V Zero  | FIS V Zero                                      |
| -10 to -5  | 6 h   | 72 h  |
| > -5 to 0  | 2 h   | 24 h  |
| > 0 to 5   | 45 min  | 12 h  |
| > 5 to 10  | 20 min  | 6 h   |
| > 10 to 15                                       | 8 min   | 3 h   |
| > 15 to 20                                       | 5 min   | 2 h   |
| > 20 to 25                                       | 3 min   | 1 h   |
| > 25 to 30                                       | 2 min   | 45 min  |
| > 30 to 40                                       | 1 min   | 30 min  |

- 1) Maximum time from the beginning of the injection to rebar / fischer rebar anchor setting and positioning  
2) For wet concrete the curing time must be doubled  
3) If the temperature in the concrete falls below 10°C the cartridge has to be warmed up to +20°C.  
If the temperature in the concrete exceeds 30°C the cartridge has to be cooled down to +20°C

**Table B6.2: Installation tools for drilling and cleaning the bore hole and injection of the mortar**

| reinforcing bars (rebar)<br>$\phi$ [mm] | fischer rebar anchor<br>[-]                        | Drilling and cleaning                    |  |                                    |                                     | Injection  |   |
|---|--|--|--|------------------------------------|-------------------------------------|--|---|
|   |  | Nominal drill bit diameter<br>$d_0$ [mm] | Diameter of cutting edge<br>$d_{cut}$ [mm] | Steel brush diameter<br>$d_b$ [mm] | Diameter of cleaning nozzle<br>[mm] | extension tube 9mm<br>Injection adapter [colour] | extension tube 15mm<br>Injection adapter [colour] |
| 8 <sup>1)</sup>                         | ---  | 10 <sup>2)</sup>                         | $\leq 10,50$                               | 11                                 | ---                                 | ---  | ---   |
|   |  | 12                                       | $\leq 12,50$                               | 14                                 |                                     |  |   |
| 10 <sup>1)</sup>                        | ---  | 12                                       | $\leq 12,50$                               | 14                                 | 11                                  | nature   | ---   |
|   |  | 14                                       | $\leq 14,50$                               | 16                                 |                                     | blue   | ---   |
| 12 <sup>1)</sup>                        | FRA M12 <sup>1)</sup><br>FRA HCR M12 <sup>1)</sup> | 14                                       | $\leq 14,50$                               | 16                                 | 15                                  | red  | ---   |
|   |  | 16                                       | $\leq 16,50$                               | 20                                 |                                     | yellow   | ---   |
| 14                                      | ---  | 18                                       | $\leq 18,50$                               | 20                                 | 19                                  | green  | green   |
| 16                                      | FRA M16<br>FRA HCR M16                             | 20                                       | $\leq 20,55$                               | 25                                 |                                     | black  | black   |
| 20                                      | FRA M20<br>FRA HCR M20                             | 25                                       | $\leq 25,55$                               | 27                                 |                                     | blue   | blue  |
| 22                                      | ---  | 28                                       | $\leq 28,55$                               | 30                                 | 28                                  | grey   | grey  |
| 24                                      | ---  | 30                                       | $\leq 30,55$                               | 40                                 |                                     | ---  | ---   |
| 25                                      | FRA M24 <sup>1)</sup><br>FRA HCR M24 <sup>1)</sup> | 30                                       | $\leq 30,55$                               | 40                                 |                                     | ---  | ---   |

- 1) Both drill bit diameters can be used  
2) Only hammer drilling with standard drill bit

Rebar connection with fischer injection system FIS V Zero

**Intended use**  
Working times and curing times;  
Installation tools for drilling and cleaning the bore hole and injection of the mortar

**Annex B 6**

Appendix 13 / 22

## Safety regulations



Review the Safety Data Sheet (SDS) before use for proper and safe handling!  
Wear well-fitting protective goggles and protective gloves when working with mortar FIS V Zero.  
Important: Observe the instructions for use provided with each cartridge.

## Installation instruction part 1

### Hole drilling

Note: Before drilling, remove carbonated concrete; clean contact areas (see Annex B 2)  
In case of aborted drill holes the drill hole shall be filled with mortar.

#### 1 Hammer drilling or compressed air drilling

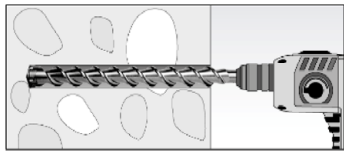

Drill the hole to the required embedment depth using a hammer drill with carbide drill bit set in rotation hammer mode or a pneumatic drill.  
Drill bit sizes see **table B6.2**.

#### 1b Hammer drilling with hollow drill bit

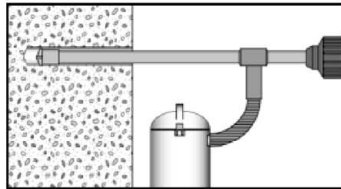

Drill the hole to the required embedment depth using a hammer drill with hollow drill bit in rotation hammer mode.  
Dust extraction conditions see drill hole cleaning **annex B 8**.  
Drill bit sizes see **table B6.2**

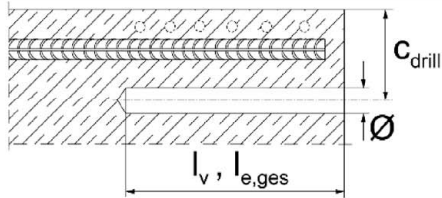

Measure and control concrete cover  $c$   
( $c_{drill} = c + \varnothing / 2$ )  
Drill parallel to surface edge and to existing rebar.  
Where applicable use fischer drilling aid.

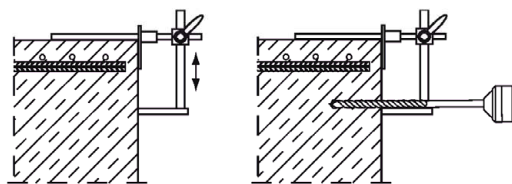

For holes  $l_v > 20$  cm use drilling aid.  
Three different options can be considered:  
A) fischer drilling aid  
B) Slat or spirit level  
C) Visual check

Minimum concrete cover  $c_{min}$  see **table B5.1**

Go to step 3 or 4

Rebar connection with fischer injection system FIS V Zero

**Intended use**  
Safety regulations; Installation instruction part 1, hole drilling

**Annex B 7**

Appendix 14 / 22

## Installation instruction part 2

### Drill hole cleaning with oil-free compressed air

Hammer or compressed air drilling

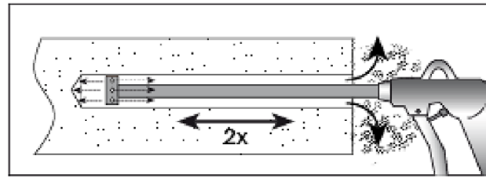

#### Blowing

twice from the back of the hole with the appropriate nozzle (oil-free compressed air  $\geq 6$  bar) until return air stream is free of noticeable dust.

Personal protective equipment must be used. (see safety regulations **Annex B 7**).

3

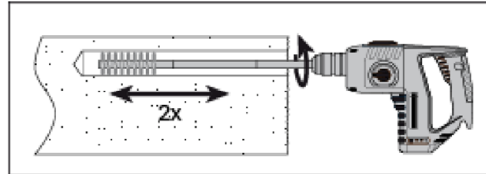

#### Brushing (with power drill)

Check steel brush with brush control template. The brush must produce a noticeable resistance when it is inserted into the drill hole.

Fix an adequate steel brush with an extension into a drilling machine and brush the bore hole twice.

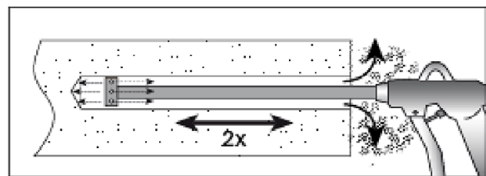

#### Blowing

twice from the back of the hole with the appropriate nozzle (oil-free compressed air  $\geq 6$  bar) until return air stream is free of noticeable dust.

Personal protective equipment must be used. (see safety regulations **Annex B 7**).

Go to step 7

Rebar connection with fischer injection system FIS V Zero

#### Intended use

Installation instruction part 2, drill hole cleaning

**Annex B 8**

Appendix 15 / 22



### Installation instruction part 3

Drill hole cleaning: manual cleaning is permitted for hammer drilled boreholes up to hole diameters  $d_0 < 18 \text{ mm}$  and depths  $l_v$  resp.  $l_{e,ges} \leq 12 \times \phi$

4

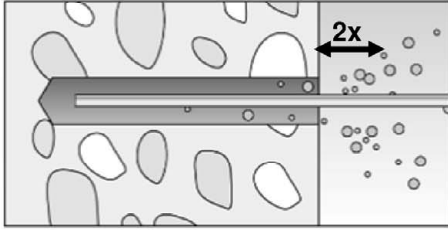

#### Blowing

blow out the hole twice by hand from the back of the hole. Use only the fischer blow out pump AB G. Personal protective equipment must be used (see safety regulations **Annex B 7**).

5

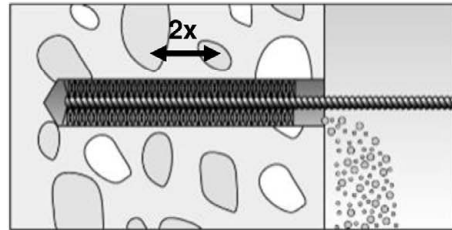

#### Brushing

Twice with the specified brush size by inserting the round steel brush to the back of the hole and twisting motion. The brush must produce a noticeable resistance when it is inserted into the drill hole. Corresponding brushes see **table B6.2**.

6

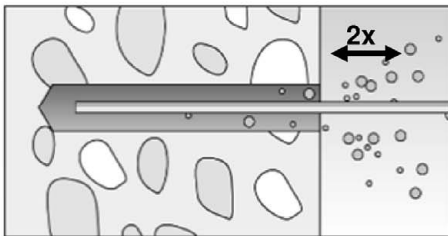

#### Blowing

blow out the hole twice by hand from the back of the hole. Use only the fischer blow out pump AB G. Personal protective equipment must be used. (see safety regulations **Annex B 7**).

#### Hammer drilling with hollow drill bit



6b

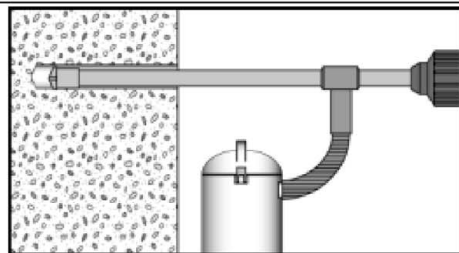

Use a suitable dust extraction system, e. g. fischer FVC 35 M or a comparable dust extraction system with equivalent performance data. Drill the hole with hollow drill bit. The dust extraction system has to extract the drill dust nonstop during the drilling process and must be adjusted to maximum power. No further drill hole cleaning necessary

Go to step 7

Rebar connection with fischer injection system FIS V Zero

#### Intended use

Installation instruction part 3, drill hole cleaning

**Annex B 9**

Appendix 16 / 22

## Installation instruction part 4

### reinforcing bars (rebar) / fischer rebar anchor and cartridge preparation

7

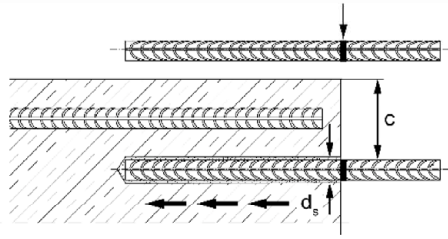

Before use, make asure that the rebar or the fischer rebar anchor is dry and free of oil or other residue. Mark the embedment depth  $l_v$  resp.  $l_{e,ges}$  (e.g. with tape) Insert rebar in borehole, to verify drill hole depth and setting depth  $l_v$  resp.  $l_{e,ges}$

8

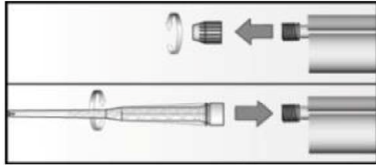

Twist off the sealing cap  
Twist on the static mixer (the spiral in the static mixer must be clearly visible).

9

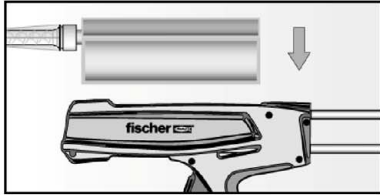

Place the cartridge into a suitable dispenser.

10

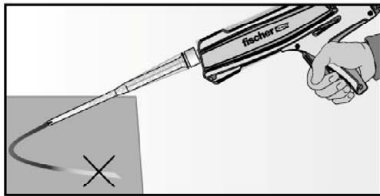

Press out approximately 10 cm of mortar until the resin is permanently grey in colour. Mortar which is not grey in colour will not cure and must be disposed.

Go to step 11

Rebar connection with fischer injection system FIS V Zero

#### Intended use

Installation instruction part 4,  
reinforcing bars (rebar) / fischer rebar anchor and cartridge preparation

**Annex B 10**

Appendix 17 / 22

## Installation instruction part 5; Installation with FIS V Zero

### Injection of the mortar without extension tube

11a

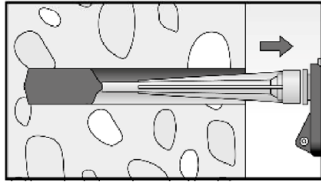

Inject the mortar from the back of the hole towards the front and slowly withdraw the mixing nozzle step by step with each trigger pull. Avoid bubbles.

Fill holes approximately 2/3 full, to ensure that the annular gap between the rebar and the concrete will be completely filled with adhesive over the entire embedment length.

The conditions for mortar injection without extension tube can be found in **table B5.3**

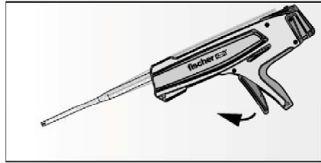

After injecting, release the dispenser. This will prevent further mortar discharge from the mixing nozzle.

### Injection of the mortar with extension tube

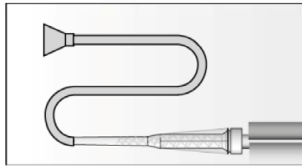

Assemble mixing nozzle FIS MR Plus or FIS JMR, extension tube and appropriate injection adapter (see **table B6.2**)

Mortar level mark

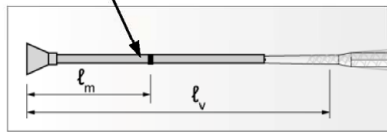

Mark the required mortar level  $l_m$  and embedment depth  $l_v$  resp.  $l_{e,ges}$  with tape or marker on the injection extension tube.

a) Estimation:

$$l_m = \frac{1}{3} * l_v \text{ resp. } l_m = \frac{1}{3} * l_{e,ges}$$

b) Precise equation for optimum mortar volume:

$$l_m = l_v \text{ resp. } l_{e,ges} \left( (1,2 * \frac{d_s^2}{d_0^2} - 0,2) \right) [\text{mm}]$$

11b

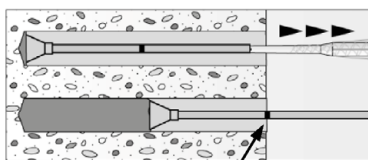

Mortar level mark

Insert injection adapter to back of the hole. Begin injection allowing the pressure of the injected adhesive mortar to push the injection adapter towards the front of the hole. Do not actively pull out!

Fill holes approximately 2/3 full, to ensure that the annular gap between the rebar and the concrete will be completely filled with adhesive over the embedment length.

When using an injection adapter continue injection until the mortar level mark  $l_m$  becomes visible.

Maximum embedment depth see **table B5.2**

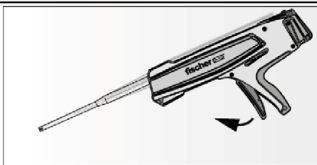

After injecting, release the dispenser. This will prevent further mortar discharge from the mixing nozzle.

Go to step 12

Rebar connection with fischer injection system FIS V Zero

**Intended use**

Installation instruction part 5, mortar injection

**Annex B 11**

Appendix 18 / 22

## Installation instruction part 6; Installation with FIS V Zero

### Insert rebar / fischer rebar anchor

|    |  |  |
|----|--|--|
| 12 |  | <p>Insert the rebar / fischer rebar anchor slowly twisted into the borehole until the embedment mark is reached.</p> <p>Recommendation:<br/>Rotation back and forth of the reinforcement bar or the fischer rebar anchor FRA makes pushing easy</p>  |
| 13 |  | <p>After installing the rebar or fischer rebar anchor the annular gap must be completely filled with mortar.</p> <p>Proper installation</p> <ul style="list-style-type: none"> <li>• Desired embedment depth is reached <math>l_v</math> resp. <math>l_{e,ges}</math>: embedment mark at concrete surface</li> <li>• Excess mortar flows out of the borehole after the rebar or fischer rebar anchor have been fully inserted up to the embedment mark.</li> </ul> |
| 14 |  | <p>For overhead installation, support the rebar / fischer rebar anchor and secure it from falling till mortar started to harden, e.g. using wedges.</p>  |
| 15 |  | <p>Observe the working time "<math>t_{work}</math>" (see <b>table B6.1</b>), which varies according to temperature of base material. Minor adjustments to the rebar / fischer rebar anchor position may be performed during the working time</p> <p>Full load may be applied only after the curing time "<math>t_{cure}</math>" has elapsed (see <b>table B6.1</b>)</p>  |
| 16 |  | <p>Mounting the fixture,<br/>max <math>T_{fix}</math> see <b>table A 6.1</b></p>   |

Rebar connection with fischer injection system FIS V Zero

#### Intended use

Installation instruction part 6, insert rebar / fischer rebar anchor

**Annex B 12**

Appendix 19 / 22

## Minimum anchorage length and minimum lap length

The minimum anchorage length  $l_{b,min}$  and the minimum lap length  $l_{o,min}$  according to EN 1992-1-1:2004+AC:2010 shall be multiplied by the relevant amplification factor  $\alpha_{lb}$  according to **table C1.1**.

**Table C1.1:** Amplification factor  $\alpha_{lb}$  related to concrete strength class and drilling method

### Hammer drilling, hollow drilling and compressed air drilling

| Rebar / fischer rebar anchor<br>$\phi$ [mm] | Amplification factor $\alpha_{lb}$ |        |        |        |        |        |        |        |        |
|---|------------------------------------|--------|--------|--------|--------|--------|--------|--------|--------|
|   | Concrete strength class            |        |        |        |        |        |        |        |        |
|   | C12/15                             | C16/20 | C20/25 | C25/30 | C30/37 | C35/45 | C40/50 | C45/55 | C50/60 |
| 8 to 25                                     | 1,5                                |        |        |        |        |        |        |        |        |

**Table C1.2:** Bond efficiency factor  $k_b$  for hammer drilling, hollow drilling and compressed air drilling

### Hammer drilling, hollow drilling and compressed air drilling

| Rebar / fischer rebar anchor<br>$\phi$ [mm] | Bond efficiency factor $k_b$ |        |        |        |        |        |        |        |        |
|---|------------------------------|--------|--------|--------|--------|--------|--------|--------|--------|
|   | Concrete strength class      |        |        |        |        |        |        |        |        |
|   | C12/15                       | C16/20 | C20/25 | C25/30 | C30/37 | C35/45 | C40/50 | C45/55 | C50/60 |
| 8   | 1,0                          | 1,0    | 1,0    | 0,86   | 0,76   | 0,69   | 0,73   | 0,67   | 0,63   |
| 10  | 1,0                          | 1,0    | 1,0    | 0,86   | 0,76   | 0,69   | 0,63   | 0,67   | 0,63   |
| 12  | 1,0                          | 1,0    | 1,0    | 0,86   | 0,76   | 0,69   | 0,63   | 0,58   | 0,54   |
| 14  | 1,0                          | 1,0    | 0,86   | 0,74   | 0,76   | 0,69   | 0,63   | 0,58   | 0,54   |
| 16  | 1,0                          | 1,0    | 0,86   | 0,74   | 0,66   | 0,59   | 0,63   | 0,58   | 0,54   |
| 20  | 1,0                          | 0,83   | 0,71   | 0,74   | 0,66   | 0,59   | 0,54   | 0,50   | 0,47   |
| 22  | 1,0                          | 0,83   | 0,71   | 0,61   | 0,54   | 0,59   | 0,54   | 0,50   | 0,47   |
| 24  | 1,0                          | 0,83   | 0,71   | 0,61   | 0,54   | 0,49   | 0,45   | 0,50   | 0,47   |
| 25  | 1,0                          | 0,83   | 0,71   | 0,61   | 0,54   | 0,49   | 0,45   | 0,41   | 0,47   |

**Table C1.3:** Characteristic values for **steel failure** under tension load of **fischer rebar anchors**

| fischer rebar anchor FRA / FRA HCR                        | M12 | M16 | M20 | M24 |
|---|-----|-----|-----|-----|
| <b>Bearing capacity under tension load, steel failure</b> |     |     |     |     |
| Characteristic resistance $N_{Rk,s}$ [kN]                 | 59  | 110 | 172 | 270 |
| <b>Partial factor</b>                                     |     |     |     |     |
| Partial factor $\gamma_{Ms,N}$ [-]                        | 1,4 |     |     |     |

Rebar connection with fischer injection system FIS V Zero

#### Performance

Amplification factor  $\alpha_{lb}$ , bond efficiency factor  $k_b$ ,  
Characteristic values for steel failure under tension load of fischer rebar anchors

**Annex C 1**

Appendix 20 / 22

**Table C2.1:** Design values of the bond strength  $f_{bd,PIR}$  in N/mm<sup>2</sup> for hammer drilling, hollow drilling, compressed air drilling

$$f_{bd,PIR} = k_b \cdot f_{bd}$$

$f_{bd}$ : Design value of the bond strength in N/mm<sup>2</sup> considering the concrete strength classes and the rebar diameter for good bond condition (for all other bond conditions multiply the values by  $\eta_1 = 0,7$ ) and recommended partial factor  $\gamma_c = 1,5$  according to EN 1992-1-1: 2004+AC:2010

$k_b$ : Bond efficiency factor according to **table C1.2**

**Hammer drilling, hollow drilling and compressed air drilling**

| Rebar /<br>fischer rebar<br>anchor<br><br>$\phi$ [mm] | bond strength $f_{bd,PIR}$ [N/mm <sup>2</sup> ] |        |        |        |        |        |        |        |        |
|---|---|--------|--------|--------|--------|--------|--------|--------|--------|
|   | Concrete strength class                         |        |        |        |        |        |        |        |        |
|   | C12/15  | C16/20 | C20/25 | C25/30 | C30/37 | C35/45 | C40/50 | C45/55 | C50/60 |
| 8   | 1,6   | 2,0    | 2,3    | 2,3    | 2,3    | 2,3    | 2,7    | 2,7    | 2,7    |
| 10  | 1,6   | 2,0    | 2,3    | 2,3    | 2,3    | 2,3    | 2,3    | 2,7    | 2,7    |
| 12  | 1,6   | 2,0    | 2,3    | 2,3    | 2,3    | 2,3    | 2,3    | 2,3    | 2,3    |
| 14  | 1,6   | 2,0    | 2,0    | 2,0    | 2,3    | 2,3    | 2,3    | 2,3    | 2,3    |
| 16  | 1,6   | 2,0    | 2,0    | 2,0    | 2,0    | 2,0    | 2,3    | 2,3    | 2,3    |
| 20  | 1,6   | 1,6    | 1,6    | 2,0    | 2,0    | 2,0    | 2,0    | 2,0    | 2,0    |
| 22  | 1,6   | 1,6    | 1,6    | 1,6    | 1,6    | 2,0    | 2,0    | 2,0    | 2,0    |
| 24  | 1,6   | 1,6    | 1,6    | 1,6    | 1,6    | 1,6    | 1,6    | 2,0    | 2,0    |
| 25  | 1,6   | 1,6    | 1,6    | 1,6    | 1,6    | 1,6    | 1,6    | 1,6    | 2,0    |

**Table C2.2:** Essential characteristics to **steel failure** for **fischer rebar anchors** under fire exposure R30 to R120

For concrete strength classes C12/C15 to C50/60

| fischer rebar anchor FRA / FRA HCR   |      |               |      | M12 | M16 | M20 | M24 |
|--------------------------------------|------|---------------|------|-----|-----|-----|-----|
| Characteristic<br>tensile resistance | R30  | $N_{Rk,s,fi}$ | [kN] | 1,7 | 3,1 | 4,9 | 7,1 |
|                                      | R60  |               |      | 1,3 | 2,4 | 3,7 | 5,3 |
|                                      | R90  |               |      | 1,1 | 2,0 | 3,2 | 4,6 |
|                                      | R120 |               |      | 0,8 | 1,6 | 2,5 | 3,5 |

Rebar connection with fischer injection system FIS V Zero

**Performance**

Design values of the bond strength  $f_{bd,PIR}$ ; Essential characteristics to steel failure for fischer rebar anchor  $N_{Rk,s,fi}$  under fire exposure

**Annex C 2**

## The bond strength $f_{bk,fi}$ at increased temperature for concrete strength classes C12/15 to C50/60 (all drilling methods)

The bond strength  $f_{bk,fi}$  at increased temperature has to be calculated by the following equation:

$$f_{bk,fi} = k_{fi}(\theta) \cdot f_{bd,PIR} \cdot \gamma_c$$

$$\text{If: } \theta > 37 \text{ } ^\circ\text{C} \quad k_{fi}(\theta) = \frac{13,898 \cdot e^{-0,009 \cdot \theta}}{f_{bd,PIR} \cdot 4,3} \leq 1.0$$

$$\text{If: } \theta > \theta_{\max} (347,0 \text{ } ^\circ\text{C}) \quad k_{fi}(\theta) = 0$$

- $f_{bk,fi}$  = The bond strength at increased temperature in N/mm<sup>2</sup>
- $(\theta)$  = Temperature in °C in the mortar layer
- $k_{fi}(\theta)$  = Reduction factor at increased temperature
- $f_{bd,PIR}$  = Design value of the bond strength in N/mm<sup>2</sup> in cold condition according to table C2.1 considering the concrete classes, the rebar diameter, the drilling method and the bond conditions according to EN 1992-1-1:2004+AC:2010
- $\gamma_c$  = Partial factor according to EN 1992-1-1:2004+AC:2010

For evidence at increased temperature the anchorage length shall be calculated according to EN 1992-1-1:2004+AC:2010 Equation 8.3 using the temperature-dependent ultimate bond strength  $f_{bk,fi}$ .

**Figure C3.1:** Example graph of reduction factor  $k_{fi}(\theta)$  for concrete class C20/25 for good bond conditions

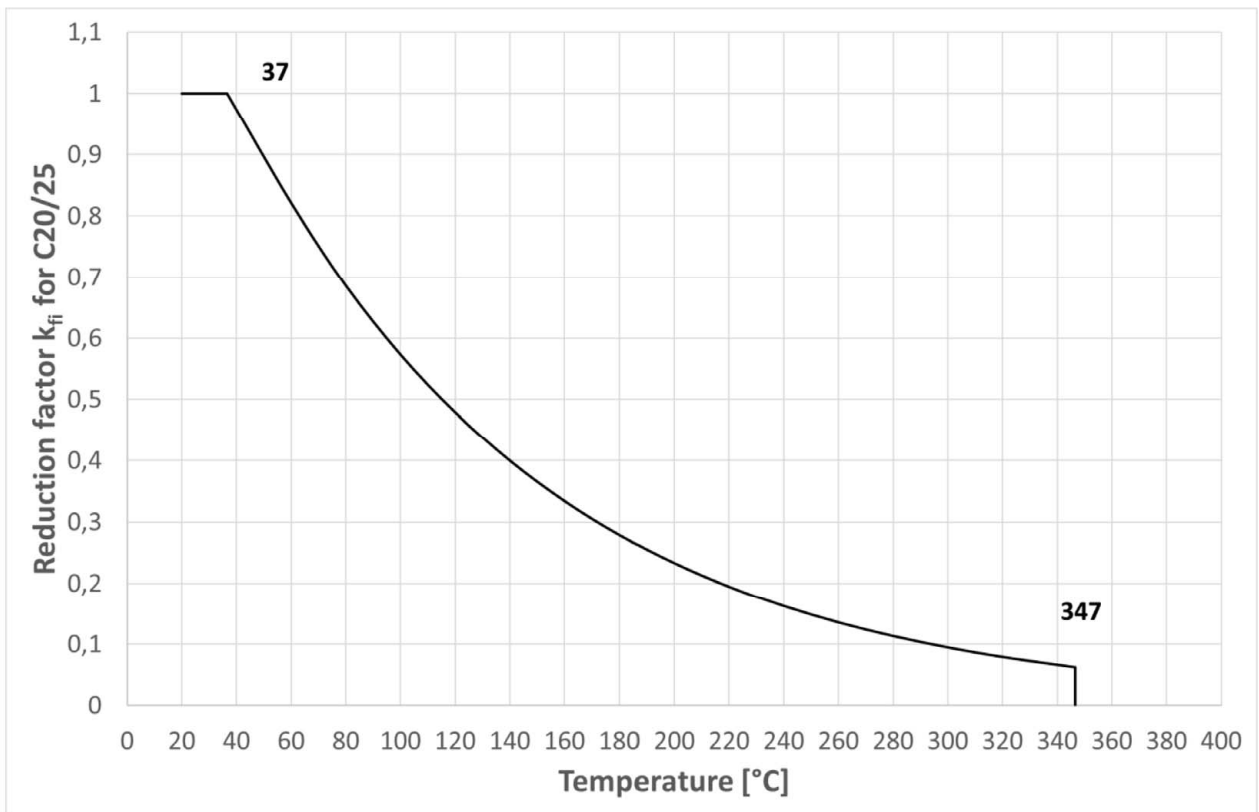

Rebar connection with fischer injection system FIS V Zero

**Performance**  
Design values of bond strength  $f_{bk,fi}$  at increased temperature

**Annex C 3**

Appendix 22 / 22