

DECLARAȚIA DE PERFORMANȚĂ

DoP 0197

pentru bulonul de ancorare fischer FH II, FH II-I (Ancore din metal pentru utilizare în beton)

RO

| | | | |
|---|---|--|-----------------------------|
| 1. <u>Cod unic de identificare al produsului-tip:</u> | DoP 0197 | | |
| 2. <u>Utilizare (utilizări) preconizată (preconizate):</u> | Prindere cu instalare ulterioară în beton fisurat sau nefisurat. Consultați suplimentul, în special anexele B1- B6 | | |
| 3. <u>Fabricant:</u> | fischerwerke GmbH & Co. KG, Klaus-Fischer-Str. 1, 72178 Waldachtal, Germany | | |
| 4. <u>Reprezentant autorizat:</u> | - | | |
| 5. <u>Sistemul (sistemele) de evaluare și de verificare a constantei performanței:</u> | 1 | | |
| 6. <u>Documentul de evaluare european:</u> | EAD 330232-00-0601 (Edition 10/ 2016) | | |
| Evaluarea tehnică europeană: | ETA-07/0025; 2020-09-23 | | |
| Organismul de evaluare tehnică: | DIBt- Deutsches Institut für Bautechnik | | |
| Organism (organisme) notificat(e): | 1343 MPA Darmstadt / 2873 TU Darmstadt | | |
| 7. <u>Performanța (performanțe) declarată (declarate):</u> | Rezistență mecanică și stabilitate (BWR 1) | | |
| Rezistența caracteristică la întindere (pentru încărcări statice și cvasistatice): | Rezistența la cedarea oțelului: Rezistența la smulgere: | Anexele C1, C2 Anexele C1, C2 | $E_s = 210\,000\text{ MPa}$ |
| | Rezistența la cedarea conului de beton: | Anexele C1, C2 | |
| | Robustețe: | Anexele C1, C2 | |
| | Distanța minimă față de margine și între ancore: | Anexele C7 | |
| | Distanța față de margine pentru a preveni fisuri sub încărcare: | Anexele C1, C2 | |
| | Deplasări sub încărcări statice și cvasistatice: | Anexele C10, C11 | |
| Rezistența caracteristică la forfecare (pentru încărcări statice și cvasistatice): | Rezistența la cedarea oțelului (rezistența la forfecare Rezistența la cedarea cu braț de levier: Rezistența la cedarea muchiei betonului: Deplasări sub încărcări statice și cvasistatice: | Anexele C3, C4 Anexele C3, C4 Anexele C3, C4 Anexele C10, C11 | |
| | Durabilitate: | Anexele A4, B1 | |
| Rezistența caracteristică și Deplasări pentru performanță seismică de categoriile C1 și C2: | Rezistența la cedarea oțelului: | Anexele C8, C9 | |
| | Rezistența la smulgere: | Anexele C8, C9 | |
| | Alungirea la rupere: | >8% | |
| | Factor gol circular: | Anexele C8, C9 | |
| | Deplasări: | Anexele C11 | |
| Siguranța în caz de incendiu (BWR 2) | | | |
| Reacție la foc: | Clasa (A1) | | |
| Rezistența la incendiu: | Rezistența la foc în ipoteza cedării oțelului Rezistența la foc în ipoteza cedării prin smulgere Rezistența la foc în ipoteza cedării oțelului | Anexele C5 Anexele C5 Anexele C6 | |



8. Documentație tehnică adecvată și/sau documentație tehnică specifică: -

Performanța produsului identificat mai sus este în conformitate cu setul de performanțe declarate. Această declarație de performanță este eliberată în conformitate cu Regulamentul (UE) nr. 305/2011, pe răspunderea exclusivă a fabricantului identificat mai sus.

Semnată pentru și în numele fabricantului de către:

Thilo Pregartner, Dr.-Ing.
Tumlingen, 2020-10-06

Peter Schillinger, Dipl.-Ing.

Această declarație de performanță a fost întocmită în mai multe limbi. În cazul unei divergențe de interpretare, versiunea în limba engleză prevalează întotdeauna.

Suplimentul include informații voluntare și complementare în limba engleză, în afara cerințelor legale (specificate neutru din punct de vedere al limbii).

Specific Part

1 Technical description of the product

The fischer High-Performance Anchor FH II, FH II-I is an anchor made of galvanised steel (sizes with external diameter 10, 12, 15, 18, 24, 28 and 32, sizes with internal thread 12/M6 I, 12/M8 I, 15/M10 I and 15/M12 I) or stainless steel (sizes with external diameter 10, 12, 15, 18 and 24, sizes with internal thread 12/M6 I, 12/M8 I, 15/M10 I and 15/M12 I) which is placed into a drilled hole and anchored by torque-controlled expansion.

The product description is given in Annex A.

2 Specification of the intended use in accordance with the applicable European Assessment Document

The performances given in Section 3 are only valid if the fastener is used in compliance with the specifications and conditions given in Annex B.

The verifications and assessment methods on which this European Technical Assessment is based lead to the assumption of a working life of the fastener of at least 50 years. The indications given on the working life cannot be interpreted as a guarantee given by the producer, but are to be regarded only as a means for choosing the right products in relation to the expected economically reasonable working life of the works.

3 Performance of the product and references to the methods used for its assessment

3.1 Mechanical resistance and stability (BWR 1)

| Essential characteristic | Performance |
|--|--------------------------|
| Characteristic resistance to tension load (static and quasi-static loading) | See Annex C 1, C 2, C 7 |
| Characteristic resistance to shear load (static and quasi-static loading) | See Annex C 3 and C4 |
| Displacements (static and quasi-static loading) | See Annex C 10, C 11 |
| Characteristic resistance and displacements for seismic performance categories C1 and C2 | See Annex C 8, C 9, C 11 |
| Durability | See Annex B 1 |

3.2 Safety in case of fire (BWR 2)

| Essential characteristic | Performance |
|--------------------------|--------------------|
| Reaction to fire | Class A1 |
| Resistance to fire | See Annex C 5, C 6 |

4 Assessment and verification of constancy of performance (AVCP) system applied, with reference to its legal base

In accordance with the European Assessment Document EAD 330232-01-0601 the applicable European legal act is: [96/582/EC].

The system to be applied is: 1

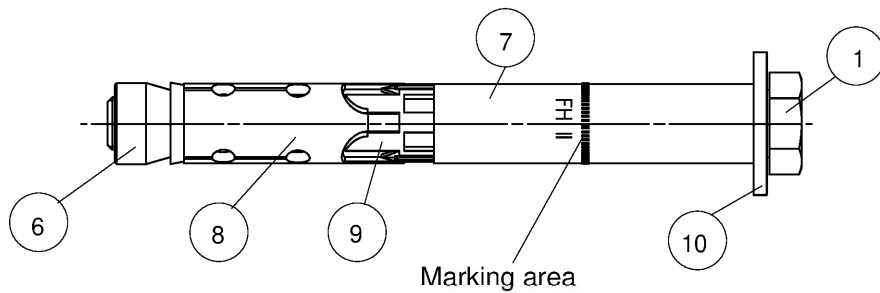

Type hexagon screw **S**
 FH II 10 - 32 S
 FH II 10 - 24 S R

Product label, example:  FH II 15/25 R



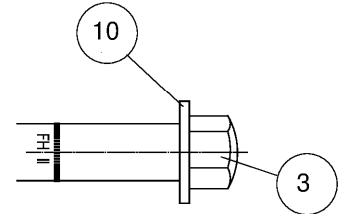
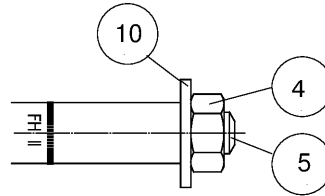
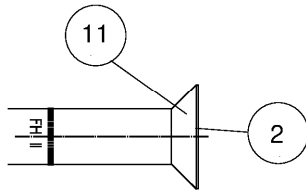









Brand _____ Identification R
 Type of fastener _____ Nominal drill hole diameter/max. thickness of fixture (t_{fix})



Type countersunk screw **SK**
 FH II 10 - 18 SK
 FH II 10 - 18 SK R

Type hexagon nut **B**
 FH II 10 - 32 B
 FH II 10 - 24 B R

Type cap nut **H**
 FH II 10 - 24 H
 FH II 10 - 24 H R

- | | | |
|---|--|--|
|  Hexagon screw |  Threaded rod |  Plastic sleeve |
|  Countersunk screw |  Cone nut |  Washer |
|  Cap nut |  Distance sleeve |  Conical washer |
|  Hexagon nut |  Expansion sleeve |  Internal thread socket |

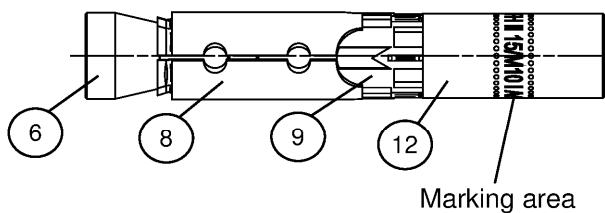

Type internal threaded anchor I
 FH II 12 M6-I or M8-I
 FH II 15 M10-I or M12-I

Product label, example:  FH II 12/M8-I R

Brand _____ Identification R
 Type of fastener _____ Nominal drill hole diameter / size of internal thread
 (Fig. not to scale)

fischer High-Performance Anchor FH II, FH II-I

Product description
 Anchor types FH II, FH II R, FH II-I, FH II-I R

Annex A 1

Appendix 2/ 22

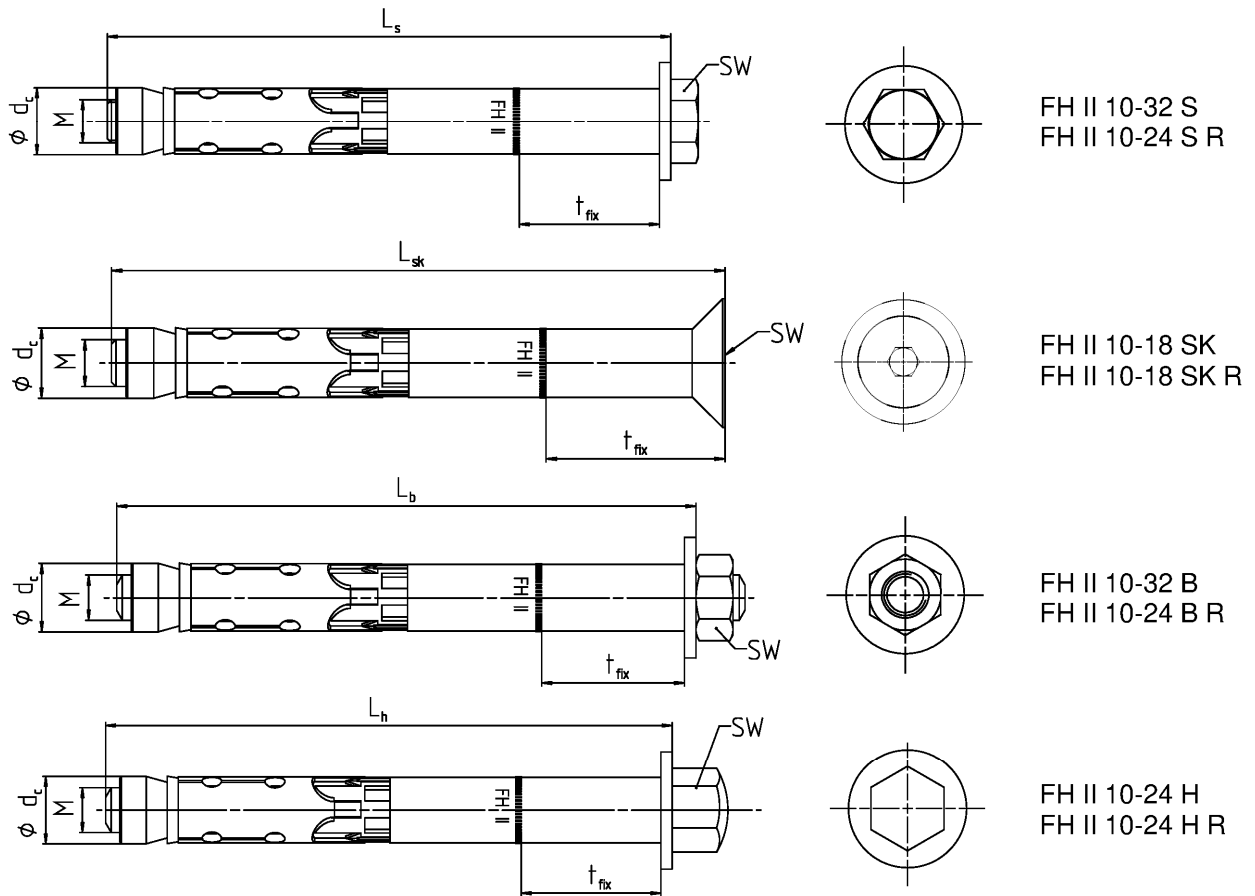

Table A2.1: Dimensions [mm] FH II and FH II R

| Anchor type | | FH II 10 | FH II 12 | FH II 15 | FH II 18 | FH II 24 | FH II 28 | FH II 32 |
|---|-----------------------------|----------|----------|----------|----------|----------|----------|----------|
| Thread | M | 6 | 8 | 10 | 12 | 16 | 20 | 24 |
| Diameter cone nut | d_c | 10 | 12 | 14,8 | 17,8 | 23,7 | 27,5 | 31,5 |
| Wrench size SW | FH II-S, -B | 10 | 13 | 17 | 19 | 24 | 30 | 36 |
| | FH II-SK ¹⁾ | 4 | 5 | 6 | 8 | 3) | | |
| | FH II-H | 13 | 17 | 17 | 19 | 24 | 3) | |
| | FH II-S R, -B R, -H R | 10 | 13 | 17 | 19 | 24 | 3) | |
| | FH II-SK R ¹⁾ | 4 | 5 | 6 | 8 | 3) | | |
| t_{fix} FH II-S, -B, -H + FH II-S R, -B R, -H R | min | 0 | 0 | 0 | 0 | 0 | 0 | 0 |
| t_{fix} FH II-SK + FH II-SK R ²⁾ | min | 5 | 6 | 6 | 8 | 3) | | |
| Length of screw / bolt | $L_s, L_h, L_b (- t_{fix})$ | ≥ 49 | ≥ 74 | ≥ 89 | ≥ 99 | ≥ 124 | ≥ 149 | ≥ 174 |
| Length of countersunk screw | $L_{sk} (- t_{fix})$ | ≥ 54 | ≥ 79 | ≥ 95 | ≥ 107 | 3) | | |

¹⁾ Internal hexagon

²⁾ The influence of the thickness of fixture to the characteristic resistance for shear loads, steel failure without lever arm is taken into account, see tables C3.1, C8.1 and C9.1

³⁾ Anchor type not part of assessment

(Fig. not to scale)

fischer High-Performance Anchor FH II, FH II-I

Product description

Anchor types and dimensions FH II, FH II R

Annex A 2

Table A3.1: Material FH II and FH II R

| No. | Designation | Material | |
|-----|-------------------|--|--|
| | | FH II | FH II R |
| | Steel grade | Steel | Stainless steel R |
| | | Zinc plated $\geq 5 \mu\text{m}$, ISO 4042:2018 | Acc. to EN 10088:2014 |
| 1 | Hexagon screw | Steel class 8.8; EN ISO 898-1:2013 | Class 80 EN ISO 3506:2020 |
| 2 | Countersunk screw | | |
| 3 | Cap nut | | |
| 4 | Hexagon nut | | |
| 5 | Threaded rod | Steel $f_{uk} \geq 800 \text{ N/mm}^2$; $f_{yk} \geq 640 \text{ N/mm}^2$ | Stainless steel EN 10088:2014 $f_{uk} \geq 800 \text{ N/mm}^2$; $f_{yk} \geq 640 \text{ N/mm}^2$ |
| 6 | Cone nut | Steel EN 10277:2018 | Stainless steel EN 10088:2014 |
| 7 | Distance sleeve | Steel EN 10305:2016 | |
| 8 | Expansion sleeve | Steel EN 10139:2020/ EN 10277:2018 | |
| 9 | Plastic sleeve | ABS (plastic) | |
| 10 | Washer | Steel EN 10139:2020 | Stainless steel EN 10088:2014 |
| 11 | Conical washer | Steel EN 10277:2018 | |

fischer High-Performance Anchor FH II, FH II-I

Product description
Materials FH II and FH II R

Annex A 3

Appendix 4/ 22

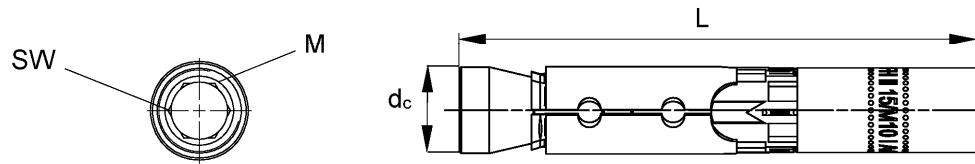

Table A4.1: Anchor Dimensions [mm] FH II-I and FH II-I R

| Anchor type FH II-I, FH II-I R | | FH II 12/M6 I | FH II 12/M8 I | FH II 15/M10 I | FH II 15/M12 I |
|--------------------------------|----------------|------------------|------------------|-------------------|-------------------|
| Thread | M | 6 | 8 | 10 | 12 |
| Diameter cone nut | d _c | 12 | 12 | 14,8 | 14,8 |
| Wrench size internal hexagon | SW | 6 | 8 | 6 | 8 |
| Anchor length | L | 77,5 | 77,5 | 90 | 90 |

Table A4.2: Material FH II-I and FH II-I R

| No. | Designation | Material | |
|----------------------------------|----------------------|---|---|
| | | FH II-I | FH II-I R |
| | Steel grade | Steel | Stainless steel R |
| | | Zinc plated $\geq 5 \mu\text{m}$, ISO 4042:2018 | Acc. to EN 10088:2014 |
| 6 | Cone nut | Steel EN 10277:2018 | Stainless steel EN 10088:2014 |
| 8 | Expansion sleeve | Steel EN 10139:2020 / EN 10277:2018 | |
| 9 | Plastic sleeve | ABS (plastic) | |
| 12 | Internal thread bolt | Steel EN 10277:2018 $f_{uk} \geq 750 \text{ N/mm}^2$, $f_{yk} \geq 600 \text{ N/mm}^2$ | Stainless steel EN 10088:2014 $f_{uk} \geq 750 \text{ N/mm}^2$, $f_{yk} \geq 600 \text{ N/mm}^2$ |
| Requirements for fixing elements | | Steel strength class 5.8, 6.8 or 8.8 EN ISO 898-1:2013 | Steel strength class A50, A70 or A80 EN ISO 3506:2010 1.4362, 1.4401, 1.4404, 1.4571, 1.4529 |

(Fig. not to scale)

fischer High-Performance Anchor FH II, FH II-I

Product description



Anchor types, dimensions and materials FH II-I, FH II I-R

Annex A 4

Appendix 5/ 22

Specifications of intended use

Anchorage subject to:

| Size | | 10 | 12 | 15 | 18 | 24 | 28 | 32 |
|---|---|----|----|----|----|----|----|----|
| High Performance Anchor | FH II-S, -B | | | | ✓ | | | |
| | FH II-H, -S R, -B R, -H R | | | ✓ | | | | 1) |
| | FH II-SK, FH II-SK R | | ✓ | | | | | 1) |
| High Performance Anchor FH II-I, FH II-I R | | 1) | ✓ | | | | | 1) |
| Hammer drilling with standard drill bit |  | | | | | | | |
| Hammer drilling with hollow drill bit with automatic cleaning |  | | | | ✓ | | | |
| Static and quasi-static loads | | | | | | | | |
| Cracked and uncracked concrete | | | | | ✓ | | | |
| Fire exposure | | | | | | | | |
| Seismic performance category | C1 FH II | | | | ✓ | | | |
| | C1 FH II R | 2) | | ✓ | | | | 1) |
| | C2 FH II | | | | ✓ | | | |
| | C2 FH II R | | | ✓ | | | | 1) |
| | C1 FH II-I, FH II-I R | 1) | | 2) | | | | 1) |
| | C2 FH II-I, FH II-I R | | | | | | | |

1) Anchor type not part of the assessment

2) No performance assessed

Base materials:

- Compacted reinforced or unreinforced normal weight concrete without fibres (cracked and uncracked) of strength classes C20/25 to C50/60 according to EN 206:2013+A1:2016

Use conditions (Environmental conditions):

- Structures subject to dry internal conditions (FH II, FH II R, FH II-I, FH II-I R)
- Structures subject to external atmospheric exposure (including industrial and marine environment) and to permanently damp internal conditions, if no particular aggressive conditions exist (FH II R, FH II-I R)

Note: Particular aggressive conditions are e.g. permanent, alternating immersion in seawater or the splash zone of seawater, chloride atmosphere of indoor swimming pools or atmosphere with extreme chemical pollution (e.g. in desulphurization plants or road tunnels where deicing materials are used)

Design:

- Anchorages are to be designed under the responsibility of an engineer experienced in anchorages and concrete work
- Verifiable calculation notes and drawings are to be prepared taking account of the loads to be anchored. The position of the anchor is indicated on the design drawings (e.g. position of the anchor relative to reinforcement or to supports, etc.)
- Design of fastenings according to EN 1992-4:2018 and EOTA Technical Report TR 055, Edition February 2018

fischer High-Performance Anchor FH II, FH II-I

Intended use
Specifications

Annex B 1

Appendix 6/ 22

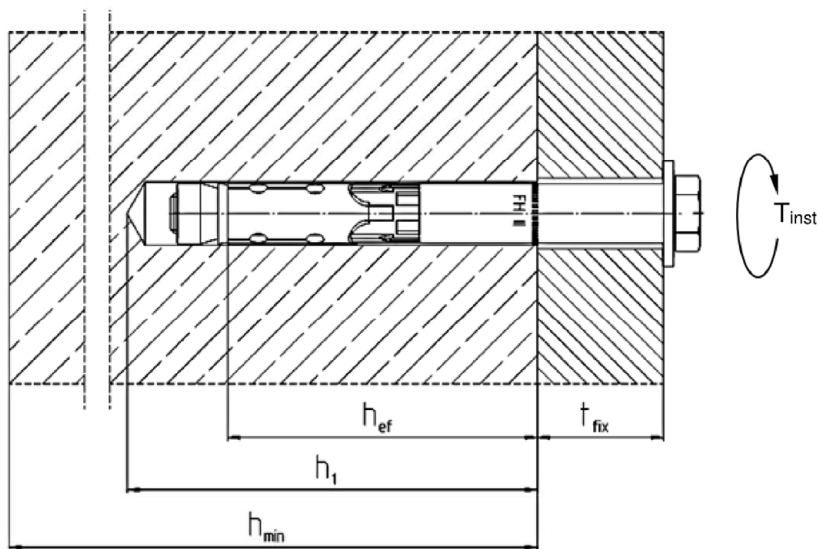

- h_{ef} = Effective embedment depth
- t_{fix} = Thickness of the fixture
- h_1 = Depth of drill hole to deepest point
- h_{min} = Minimum thickness of concrete member
- T_{inst} = Required setting torque

Table B2.1: Installation parameters FH II and FH II R

| Anchor type FH II S, -SK, -B, -H and FH II S R, -SK R, -B R, -H R | FH II 10 | FH II 12 | FH II 15 | FH II 18 | FH II 24 | FH II 28 | FH II 32 | |
|---|----------------------|----------|----------|----------|----------|----------|----------|-----|
| Nominal drill hole diameter d_0 | 10 | 12 | 15 | 18 | 24 | 28 | 32 | |
| Maximum diameter of drill bit $d_{cut} \leq$ | 10,45 | 12,50 | 15,50 | 18,50 | 24,55 | 28,55 | 32,70 | |
| Depth of drill hole to deepest $h_1 \geq$ | 55 | 80 | 90 | 105 | 125 | 155 | 180 | |
| Diameter of clearance hole $d_f \leq$ | 12 | 14 | 17 | 20 | 26 | 31 | 35 | |
| Diameter of counter sunk FH II SK | 18 | 22 | 25 | 32 | 1) | | | |
| Depth of counter sunk, 90° FH II SK R | 5,0 | 5,8 | 5,8 | 8,0 | | | | |
| Required setting torque T_{inst} [Nm] | FH II S | 22,5 | 40 | 80 | 160 | 180 | 200 | |
| | | FH II B | 17,5 | | 38 | 120 | 180 | 200 |
| | | FH II H | 22,5 | | 40 | 90 | 1) | |
| | FH II SK | 1) | | | | | | |
| | FH II S R, FH II B R | 15 | 25 | 40 | 100 | 160 | 1) | |
| | FH II H R | 10 | | | | 1) | | |
| FH II SK R | 1) | | | | | | | |

1) Anchor type not part of assessment

(Fig. not to scale)

fischer High-Performance Anchor FH II, FH II-I

Intended use
Installation parameters FH II, FH II R

Annex B 2

Appendix 7/ 22

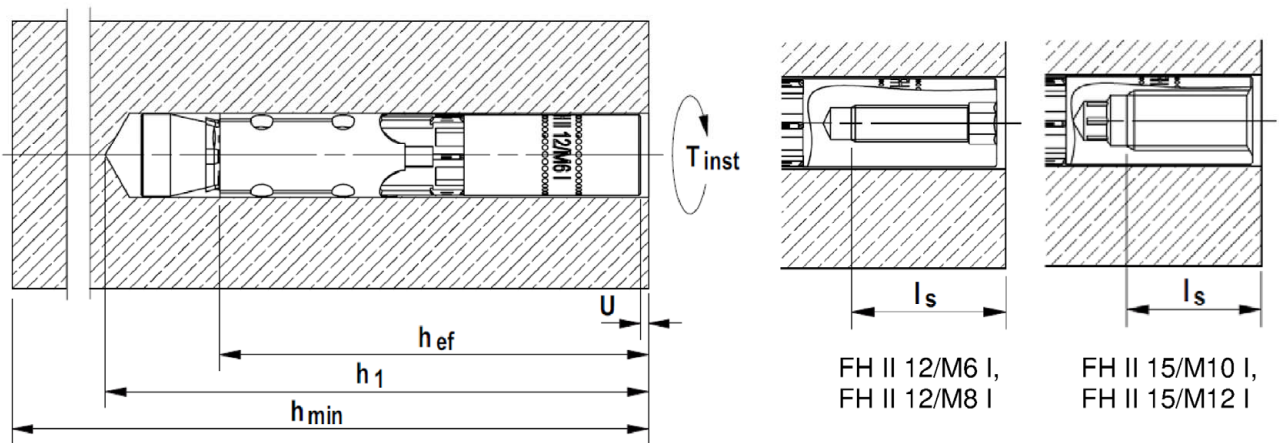

- h_{ef} = Effective embedment depth
- h_1 = Depth of drill hole to deepest point
- h_{min} = Minimum thickness of concrete member
- T_{inst} = Required setting torque
- U = Required gap after torquing
- l_s = Screw-in depth

Table B3.1: Installation parameters FH II-I and FH II-I R

| Anchor type FH II-I and FH II-I R | | FH II 12/M6 I | FH II 12/M8 I | FH II 15/M10 I | FH II 15/M12 I |
|---|---------------------|------------------|------------------|-------------------|-------------------|
| Nominal drill hole diameter | d_0 | 12 | | 15 | |
| Maximum bit diameter | $d_{cut} \leq$ | 12,50 | | 15,50 | |
| Depth of drill hole | $h_1 \geq$ [mm] | 85 | | 95 | |
| Diameter of clearance hole | $d_f \leq$ | 7 | 9 | 12 | 14 |
| Required gap after torquing ¹⁾ | U | 3 - 5 | | | |
| Required setting torque ¹⁾ | T_{inst} [Nm] | 15 | | 25 | |
| Minimum screw-in depth | $l_s \geq$ | $11 + U$ | $13 + U$ | $10 + U$ | $12 + U$ |
| Maximum screw-in depth | $l_s \leq$ [mm] | $20 + U$ | | | |
| Maximum torque on fixture in combination with screws and threaded rods strength class ≥ 5.8 resp. $\geq A50$ | $\max T_{fix}$ [Nm] | 3 | 8 | 15 | 20 |

¹⁾ At least one of the requirements concerning the gap U or the required setting torque T_{inst} have to be fulfilled

(Fig. not to scale)

fischer High-Performance Anchor FH II, FH II-I

Intended use
Installation parameters FH II-I, FH II-I R

Annex B 3

Appendix 8/ 22

Installation instructions:

- Fastener installation carried out by appropriately qualified personnel and under the supervision of the person responsible for technical matters of the site
- Use of the fastener only as supplied by the manufacturer without exchanging the components of the fastener
- Checking before placing the fastener to ensure that the strength class of the concrete in which the fastener is to be placed is in the range given and is not lower than that of the concrete to which the characteristic loads apply
- Check of concrete being well compacted, e.g. without significant voids
- Hammer or hollow drilling according to Annex B5 and B6
- Drill hole created perpendicular $\pm 5^\circ$ to concrete surface, positioning without damaging the reinforcement
- In case of aborted hole: new drilling at a minimum distance twice the depth of the aborted drill hole or smaller distance if the aborted drill hole is filled with high strength mortar and if under shear or oblique tension load it is not in the direction of load application

fischer High-Performance Anchor FH II, FH II-I

Intended Use
Installation instructions

Annex B 4

Appendix 9/ 22

Installation instruction for the fischer High-Performance anchor FH II 10 - FH II 32 and FH II 10 R - FH II 24 R

**Hollow
drilling**

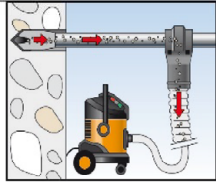

Continue with step 3, 4 and 5

**Hammer
drilling**

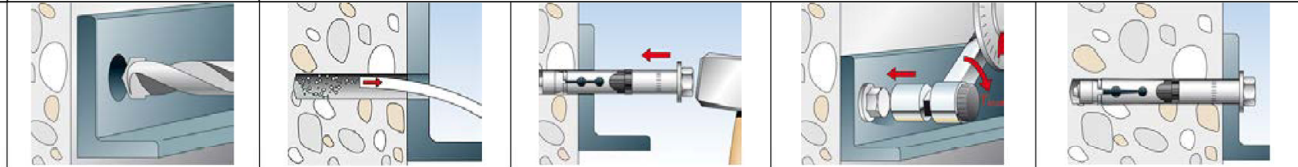

Installation instruction FH II 10 - 32 S and FH II 10 - 24 S R

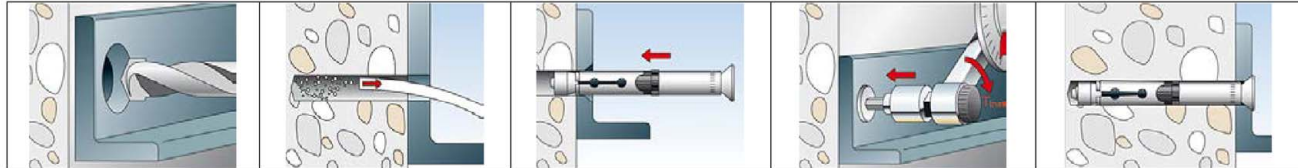

Installation instruction FH II 10 - 18 SK and FH II 10 - 18 SK R

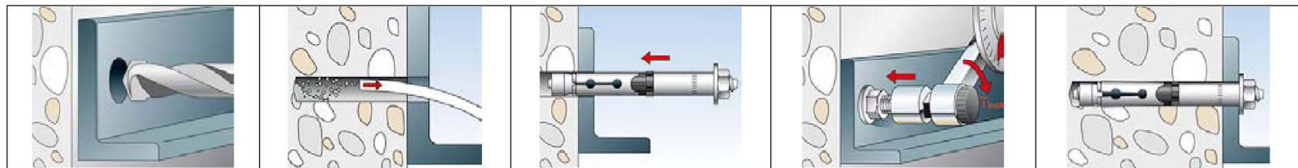

Installation instruction FH II 10 - 32 B and FH II 10 - 24 B R

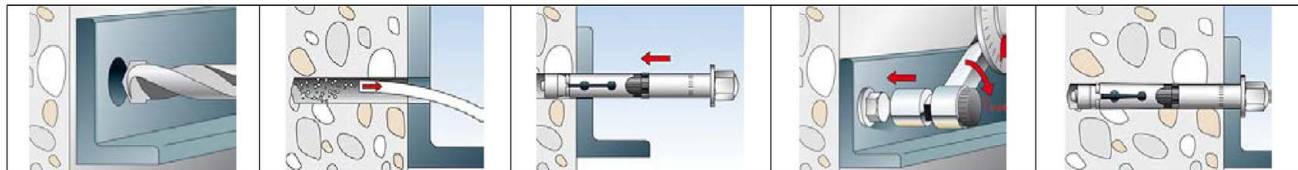

Installation instruction FH II 10 - 24 H and FH II 10 - 24 H R

| | | | | | |
|------|---|---|---|---|---|
| Step | 1 | 2 | 3 | 4 | 5 |
|------|---|---|---|---|---|

| Step | Description | |
|------|-------------------------------------|--|
| 1 | Create drill hole with hammer drill | Create drill hole with hollow drill and vacuum cleaner |
| 2 | Clean the hole | - |
| 3 | Set the fastener | |
| 4 | Apply T_{inst} | |
| 5 | Installed fastener | |

Types of drill bits

Hammer drill



Hollow drill



fischer High-Performance Anchor FH II, FH II-I



Intended use

Installation instructions FH II, FH II R

Annex B 5

Appendix 10/ 22

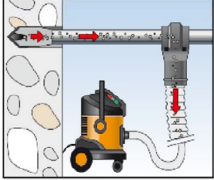
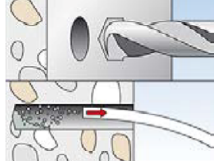
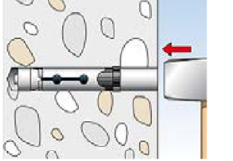
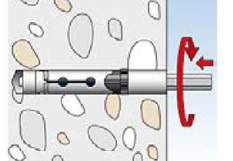
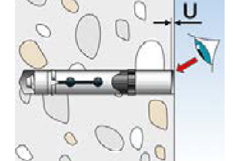
Installation instruction for the fischer High-Performance anchor internal thread
FH II-I and FH II-I R

| | | | | | |
|------------------------|---|---|---|--|---|
| Hollow drilling |  | Continue with step 2, 3, and 4 | | | |
| Hammer drilling |  |  |  |  |  |
| Step | 1 | 2 | 3 | 4 | |

| Step | Description | |
|------|---|--|
| 1 | Create drill hole with hammer drill, clean drill hole | Create drill hole with hollow drill and vacuum cleaner |
| 2 | Hammering in the anchor flushed with the surface of the concrete | |
| 3 | Tighten the anchor. The included hexagon bit in the package should be used. Other tightening methods are allowed. Tighten the anchor in the concrete until the gap U is 3 - 5 mm or the required setting torque T_{inst} is reached. Only one of the above requirements has to be fulfilled. | |
| 4 | Attach the fixture and use a suitable screw or anchor rod. The length of the screw or anchor rod should be determined depending on the thickness of fixture t_{fix} , admissible tolerances, and available thread length $l_{s,max}$ and $l_{s,min}$ including the gap U. Tighten the screw with the torque $\leq \max T_{fix}$ ($\max T_{fix}$ see table B3.1) | |

Types of drill bits

Hammer drill



Hollow drill



fischer High-Performance Anchor FH II, FH II-I

Intended use

Installation instructions FH II-I, FH II-I R

Annex B 6

Appendix 11/ 22

Table C1.1: Performance characteristics of tension resistance under static and quasi-static loads for FH II and FH II R

| Anchor type FH II-S, -SK, -B, -H and FH II-S R, -SK R, -B R, -H R | | FH II 10 | FH II 12 | FH II 15 | FH II 18 | FH II 24 | FH II 28 | FH II 32 | | |
|--|--|-----------------------------|----------|---|----------|----------|----------|---------------------|-------|------|
| Steel failure | | | | | | | | | | |
| FH II-S, -B, | | 16,1 | 29,3 | 46,4 | 67,4 | 125,3 | 195,8 | 282,0 | | |
| FH II-H, FH II-H R, -B R | | $N_{Rk,s}$ | [kN] | 16,1 | 29,3 | 46,4 | 67,4 | 125,3 ²⁾ | | |
| FH II-SK | | 16,1 | 29,3 | 46,4 | 67,4 | 2) | | | | |
| Partial factor | | γ_{Ms} ¹⁾ | [-] | 1,5 | | | | | | |
| FH II-S R | | $N_{Rk,s}$ | [kN] | 16,1 | 29,3 | 46,4 | 67,4 | 125,3 ²⁾ | | |
| FH II-SK R | | 16,1 | 29,3 | 46,4 | 67,4 | 2) | | | | |
| Partial factor | | γ_{Ms} ¹⁾ | [-] | 1,6 | | | | | | |
| Pullout failure | | | | | | | | | | |
| Characteristic resistance in cracked concrete C20/25 FH II and FH II R | | $N_{Rk,p}$ | [kN] | 7,5 | 12,0 | 16,0 | 25,0 | 34,4 | 48,1 | 63,3 |
| Characteristic resistance in uncracked concrete C20/25 FH II | | $N_{Rk,p}$ | [kN] | 12,5 | 22,9 | 28,8 | 35,2 | 49,2 | 68,8 | 90,4 |
| Characteristic resistance in uncracked concrete C20/25 FH II R | | | | 12,5 | 20,0 | 28,8 | 35,2 | 49,2 | 2) | |
| Increasing factors for $N_{Rk,p}$ for cracked and uncracked concrete | | ψ_c | C25/30 | 1,12 | | | | | | |
| | | | C30/37 | 1,22 | | | | | | |
| | | | C35/45 | 1,32 | | | | | | |
| | | | C40/50 | 1,41 | | | | | | |
| | | | C45/55 | 1,50 | | | | | | |
| | | | C50/60 | 1,58 | | | | | | |
| Installation factor | | γ_{inst} | [-] | 1,0 | | | | | | |
| Concrete cone failure and splitting failure | | | | | | | | | | |
| Effective embedment depth | | h_{ef} | [mm] | 40 | 60 | 70 | 80 | 100 | 125 | 150 |
| Factor for cracked concrete | | $k_{cr,N}$ | [-] | 7,7 ³⁾ | | | | | | |
| Factor for uncracked concrete | | $k_{ucr,N}$ | [-] | 11,0 ³⁾ | | | | | | |
| Spacing | | $s_{cr,N}$ | [mm] | 120 | 180 | 210 | 240 | 300 | 375 | 450 |
| Edge distance | | $c_{cr,N}$ | [mm] | 60 | 90 | 105 | 120 | 150 | 187,5 | 225 |
| Spacing (splitting) | | $s_{cr,sp}$ | [mm] | 190 | 300 | 320 | 340 | 380 | 480 | 570 |
| Edge distance (splitting) | | $c_{cr,sp}$ | [mm] | 95 | 150 | 160 | 170 | 190 | 240 | 285 |
| Characteristic resistance (splitting) | | $N^0_{Rk,sp}$ | [kN] | $\min \{N^0_{Rk,c}, N_{Rk,p}\}$ ⁴⁾ | | | | | | |
| ¹⁾ In absence of other national regulations ²⁾ Anchor type no performance assessed ³⁾ Based on concrete strength as cylinder strength ⁴⁾ $N^0_{Rk,c}$ acc. EN 1992-4:2018 | | | | | | | | | | |

fischer High-Performance Anchor FH II, FH II-I

Performances

Performance characteristics of tension resistance for FH II and FH II R

Annex C 1

Table C2.1: Performance characteristics of **tension resistance** under static and quasi-static loads for **FH II-I and FH II-I R**

| Anchor type FH II-I and FH II-I R | | FH II 12/M6 I | FH II 12/M8 I | FH II 15/M10 I | FH II 15/M12 I |
|---|------------------------|--------------------------------------|------------------|-------------------|-------------------|
| Steel failure | | | | | |
| Anchor in combination with screw / threaded rod of galvanised steel complying with DIN EN ISO 898 | | | | | |
| Strength class 5.8 | | 10 | 19 | 29 | 43 |
| Strength class 6.8 | $N_{Rk,s}$ [kN] | 12 | 23 | 35 | 44 |
| Strength class 8.8 | | 16 | 27 | 44 | 44 |
| Partial factor | $\gamma_{Ms}^{1)}$ [-] | 1,5 | | | |
| Anchor in combination with screw / threaded rod of stainless steel complying with DIN EN ISO 3506 | | | | | |
| Screw/thread strength class A50 | $N_{Rk,s}$ [kN] | 10 | 19 | 29 | 43 |
| Partial factor | $\gamma_{Ms}^{1)}$ [-] | 2,86 | | | |
| Screw/thread strength class A70 | $N_{Rk,s}$ [kN] | 14 | 26 | 41 | 54 |
| Partial factor | $\gamma_{Ms}^{1)}$ [-] | 1,87 | | | |
| Screw/thread strength class A80 | $N_{Rk,s}$ [kN] | 16 | 29 | 46 | 46 |
| Partial factor | $\gamma_{Ms}^{1)}$ [-] | 1,60 | | | |
| Pullout failure | | | | | |
| Characteristic resistance in cracked concrete C20/25 | $N_{Rk,p}$ [kN] | 9,0 | | 12,0 | |
| Characteristic resistance in uncracked concrete C20/25 | | 20,0 | | 28,8 | |
| Increasing factors for $N_{Rk,p}$ for cracked and uncracked concrete | ψ_c | C25/30 | 1,12 | | |
| | | C30/37 | 1,22 | | |
| | | C35/45 | 1,32 | | |
| | | C40/50 | 1,41 | | |
| | | C45/55 | 1,50 | | |
| | | C50/60 | 1,58 | | |
| Installation factor | γ_{inst} [-] | 1,0 | | | |
| Concrete cone failure and splitting failure | | | | | |
| Effective embedment depth | h_{ef} [mm] | 60 | | 70 | |
| Factor for cracked concrete | $k_{cr,N}$ [-] | 7,7 ²⁾ | | | |
| Factor for uncracked concrete | $k_{ucr,N}$ [-] | 11,0 ²⁾ | | | |
| Spacing | $s_{cr,N}$ | 180 | | 210 | |
| Edge distance | $c_{cr,N}$ [mm] | 90 | | 105 | |
| Spacing (splitting) | $s_{cr,sp}$ | 300 | | 320 | |
| Edge distance (splitting) | $c_{cr,sp}$ | 150 | | 160 | |
| Characteristic resistance (splitting) | $N^0_{Rk,sp}$ [kN] | $\min \{N^0_{Rk,c}, N_{Rk,p}\}^{3)}$ | | | |
| ¹⁾ In absence of other national regulations ²⁾ Based on concrete strength as cylinder strength ³⁾ $N^0_{Rk,c}$ acc. EN 1992-4:2018 | | | | | |

fischer High-Performance Anchor FH II, FH II-I

Performances

Performance characteristics of tension resistance for FH II-I and FH II-I R

Annex C 2

Appendix 13/ 22

Table C3.1: Performance characteristics of **shear resistance** for **FH II and FH II R** under static and quasi-static loads

| Anchor type FH II-S, -SK, -B, -H and FH II-S R, -SK R, -B R, -H R | | FH II 10 | FH II 12 | FH II 15 | FH II 18 | FH II 24 | FH II 28 | FH II 32 |
|---|------------------------|------------------|----------|-----------|----------|----------|----------|----------|
| Installation factor | γ_{inst} [-] | 1,0 | | | | | | |
| Steel failure without lever arm | | | | | | | | |
| FH II-S | | 18,0 | 33,0 | 59,0 | 76,0 | 146,0 | 176,4 | 217,0 |
| FH II-B | $V_{RK,s}^0$ [kN] | 16,0 | 27,2 | 42,8 | 61,9 | 119,0 | 148,8 | 169,0 |
| FH II-H | | 16,0 | 27,2 | 42,8 | 61,9 | 119,0 | 3) | |
| FH II-SK | $t_{fix}^{2)}$ [mm] | ≥ 10 | | ≥ 15 | | 3) | | |
| | $V_{RK,s}^0$ [kN] | 18,0 | 33,0 | 59,0 | 76,0 | | | |
| | $t_{fix}^{2)}$ [mm] | < 10 | | < 15 | | | | |
| | $V_{RK,s}^0$ [kN] | 8,0 | 14,0 | 23,0 | 34,0 | | | |
| Partial factor | $\gamma_{Ms}^{1)}$ [-] | 1,25 | | | | | | |
| Factor for ductility | k_7 | 1,0 | | | | | | |
| FH II-S R | $V_{RK,s}^0$ [kN] | 18,0 | 33,0 | 59,0 | 76,0 | 146,0 | 3) | |
| Partial factor | $\gamma_{Ms}^{1)}$ [-] | 1,33 | | | | | | |
| FH II-B R, -H R | $V_{RK,s}^0$ [kN] | 16,0 | 27,2 | 42,8 | 61,9 | 119,0 | 3) | |
| Partial factor | $\gamma_{Ms}^{1)}$ [-] | 1,25 | | | | | | |
| FH II-SK R | $t_{fix}^{2)}$ [mm] | ≥ 10 | | ≥ 15 | | 3) | | |
| | $V_{RK,s}^0$ [kN] | 18,0 | 33,0 | 59,0 | 76,0 | | | |
| | $t_{fix}^{2)}$ [mm] | < 10 | | < 15 | | | | |
| | $V_{RK,s}^0$ [kN] | 8,0 | 14,0 | 23,0 | 34,0 | | | |
| Partial factor | $\gamma_{Ms}^{1)}$ [-] | 1,33 | | | | | | |
| Factor for ductility | k_7 | 1,0 | | | | | | |
| Steel failure with lever arm and concrete pryout failure | | | | | | | | |
| Characteristic bending resistance FH II-S, -SK, -B, -H | $M_{RK,s}^0$ [Nm] | 12 | 30 | 60 | 105 | 266 | 518 | 896 |
| Partial factor | $\gamma_{Ms}^{1)}$ [-] | 1,25 | | | | | | |
| Characteristic bending resistance FH II R | $M_{RK,s}^0$ [Nm] | 12 | 30 | 60 | 105 | 266 | 3) | |
| Partial factor | $\gamma_{Ms}^{1)}$ [-] | FH II-B R, -H R | | 1,25 | | | | |
| | | FH II-S R, -SK R | | 1,33 | | | | |
| Factor for pryout failure | k_8 [-] | 1,0 | 2,0 | | | | | |
| Concrete edge failure | | | | | | | | |
| Effective embedment depth for calculation | $l_{r=}$ [mm] | h_{ef} | | | | | | |
| Outside diameter of a fastener | d_{nom} | 10 | 12 | 15 | 18 | 24 | 28 | 32 |

¹⁾ In absence of other national regulations

²⁾ The thickness of the fixture has influence to the characteristic resistance for shear loads, steel failure without lever arm

³⁾ No performance assessed

fischer High-Performance Anchor FH II, FH II-I

Performances

Performance characteristics of shear resistance for FH II and FH II R

Annex C 3

Appendix 14/ 22

Table C4.1: Performance characteristics of **shear resistance** for **FH II-I and FH II-I R** under static and quasi-static loads

| Anchor type FH II-I and FH II-I R | | FH II 12/M6 I | FH II 12/M8 I | FH II 15/M10 I | FH II 15/M12 I |
|---|------------------------|------------------|------------------|-------------------|-------------------|
| Installation factor | γ_{inst} [-] | 1,0 | | | |
| Steel failure without lever arm | | | | | |
| Anchor in combination with screw / threaded rod of galvanised steel complying with DIN EN ISO 898:2013 | | | | | |
| Strength class 5.8 | | 5 | 9 | 15 | 21 |
| Strength class 6.8 | $V^0_{RK,s}$ [kN] | 6 | 11 | 18 | 24 |
| Strength class 8.8 | | 8 | 14 | 23 | 24 |
| Partial factor | $\gamma_{Ms}^{1)}$ [-] | 1,25 | | | |
| Factor for ductility | k_7 | 1,0 | | | |
| Anchor in combination with screw / threaded rod of stainless steel complying with DIN EN ISO 3506:2010 | | | | | |
| Strength class A50 | $V^0_{RK,s}$ [kN] | 5 | 9 | 15 | 21 |
| Partial factor | $\gamma_{Ms}^{1)}$ [-] | 2,38 | | | |
| Strength class A70 | $V^0_{RK,s}$ [kN] | 7 | 13 | 20 | 30 |
| Partial factor | $\gamma_{Ms}^{1)}$ [-] | 1,56 | | | |
| Strength class A80 | $V^0_{RK,s}$ [kN] | 8 | 15 | 23 | 32 |
| Partial factor | $\gamma_{Ms}^{1)}$ [-] | 1,33 | | | |
| Factor for ductility | k_7 | 1,0 | | | |
| Steel failure with lever arm and concrete pryout failure | | | | | |
| Anchor in combination with screw / threaded rod of galvanised steel complying with DIN EN ISO 898:2013 | | | | | |
| Strength class 5.8 | | 8 | 19 | 37 | 65 |
| Strength class 6.8 | $M^0_{RK,s}$ [Nm] | 9 | 23 | 44 | 78 |
| Strength class 8.8 | | 12 | 30 | 60 | 105 |
| Partial factor | $\gamma_{Ms}^{1)}$ [-] | 1,25 | | | |
| Factor for ductility | k_7 | 1,0 | | | |
| Anchor in combination with screw / threaded rod of stainless steel complying with DIN EN ISO 3506:2010 | | | | | |
| Strength class A50 | $M^0_{RK,s}$ [Nm] | 8 | 19 | 37 | 65 |
| P Partial factor | $\gamma_{Ms}^{1)}$ [-] | 2,38 | | | |
| Strength class A70 | $M^0_{RK,s}$ [Nm] | 11 | 26 | 52 | 92 |
| Partial factor | $\gamma_{Ms}^{1)}$ [-] | 1,56 | | | |
| Strength class A80 | $M^0_{RK,s}$ [Nm] | 12 | 30 | 60 | 105 |
| Partial factor | $\gamma_{Ms}^{1)}$ | 1,33 | | | |
| Factor for ductility | k_7 [-] | 1,0 | | | |
| Factor for pryout failure | k_8 | 2,0 | | | |
| Concrete edge failure | | | | | |
| Effective embedment depth for calculation | $l_f =$ [mm] | h_{ef} | | | |
| Outside diameter of fastener | d_{nom} | 12 | | 15 | |

¹⁾ In absence of other national regulations

fischer High-Performance Anchor FH II, FH II-I

Performances

Performance characteristics of shear resistance for FH II-I and FH II-I R

Annex C 4

Appendix 15/ 22

Table C5.1: Performance characteristics of tension resistance under fire exposure

| Anchor type | R30 | | | R60 | | |
|---|--------------------------|--------------------------|----------------------------|---------------------------|---------------------------|-----------------------------|
| | $N_{Rk,s,fi,30}$ [kN] | $N_{Rk,p,fi,30}$ [kN] | $N_{Rk,c,fi,30}^0$ [kN] | $N_{Rk,s,fi,60}$ [kN] | $N_{Rk,p,fi,60}$ [kN] | $N_{Rk,c,fi,60}^0$ [kN] |
| FH II 10, FH II 10 R | 0,2 | 1,8 | 1,8 | 0,2 | 1,8 | 1,8 |
| FH II 12, FH II 12 R | 2,0 | 3,0 | 5,0 | 1,3 | 3,0 | 5,0 |
| FH II 15, FH II 15 R | 3,2 | 4,0 | 7,4 | 2,3 | 4,0 | 7,4 |
| FH II 18, FH II 18 R | 4,8 | 6,3 | 10,3 | 3,9 | 6,3 | 10,3 |
| FH II 24, FH II 24 R | 8,9 | 9,0 | 18,0 | 7,3 | 9,0 | 18,0 |
| FH II 28 | 13,9 | 12,6 | 31,4 | 11,3 | 12,6 | 31,4 |
| FH II 32 | 20,0 | 16,5 | 49,6 | 16,3 | 16,5 | 49,6 |
| FH II 12/M6-I, 5.8, A50 ¹⁾ | 0,1 | 2,3 | 5,0 | 0,1 | 2,3 | 5,0 |
| FH II 12/M6-I R 8.8, A70, A80 ^{1) 2)} | 0,2 | | | 0,2 | | |
| FH II 12/M8-I, 5.8, A50 ¹⁾ | 1,3 | | | 0,8 | | |
| FH II 12/M8-I R 8.8, A70, A80 ^{1) 2)} | 2,0 | | | 1,3 | | |
| FH II 15/M10-I, 5.8, A50 ¹⁾ | 2,0 | 3,0 | 7,4 | 1,4 | 3,0 | 7,4 |
| FH II 15/M10-I R 8.8, A70, A80 ^{1) 2)} | 3,2 | | | 2,3 | | |
| FH II 15/M12-I, 5.8/A50 ¹⁾ | 3,0 | | | 2,4 | | |
| FH II 15/M12-I R 8.8, A70, A80 ^{1) 2)} | 4,8 | | | 3,9 | | |
| Anchor type | R90 | | | R120 | | |
| | $N_{Rk,s,fi,90}$ [kN] | $N_{Rk,p,fi,90}$ [kN] | $N_{Rk,c,fi,90}^0$ [kN] | $N_{Rk,s,fi,120}$ [kN] | $N_{Rk,p,fi,120}$ [kN] | $N_{Rk,c,fi,120}^0$ [kN] |
| FH II 10, FH II 10 R | 0,1 | 1,8 | 1,8 | 0,1 | 1,5 | 1,5 |
| FH II 12, FH II 12 R | 0,6 | 3,0 | 5,0 | 0,2 | 2,4 | 4,0 |
| FH II 15, FH II 15 R | 1,4 | 4,0 | 7,4 | 1,0 | 3,2 | 5,9 |
| FH II 18, FH II 18 R | 3,0 | 6,3 | 10,3 | 2,6 | 5,0 | 8,2 |
| FH II 24, FH II 24 R | 5,6 | 9,0 | 18,0 | 4,8 | 7,2 | 14,4 |
| FH II 28 | 8,8 | 12,6 | 31,4 | 7,5 | 10,1 | 25,2 |
| FH II 32 | 12,6 | 16,5 | 49,6 | 10,8 | 13,2 | 39,7 |
| FH II 12/M6-I, 5.8, A50 ¹⁾ | 0,1 | 2,3 | 5,0 | 0,1 | 1,8 | 4,0 |
| FH II 12/M6-I R 8.8, A70, A80 ^{1) 2)} | 0,1 | | | 0,1 | | |
| FH II 12/M8-I, 5.8, A50 ¹⁾ | 0,4 | | | 0,1 | | |
| FH II 12/M8-I R 8.8, A70, A80 ^{1) 2)} | 0,6 | | | 0,2 | | |
| FH II 15/M10-I, 5.8, A50 ¹⁾ | 0,9 | 3,0 | 7,4 | 0,6 | 2,4 | 5,9 |
| FH II 15/M10-I R 8.8, A70, A80 ^{1) 2)} | 1,4 | | | 1,0 | | |
| FH II 15/M12-I, 5.8/A50 ¹⁾ | 1,9 | | | 1,6 | | |
| FH II 15/M12-I R 8.8, A70, A80 ^{1) 2)} | 3,0 | | | 2,6 | | |

¹⁾ Intermediate values by linear interpolation

²⁾ In combination with screw / threaded rod strength class 8.8, A70, A80

fischer High-Performance Anchor FH II, FH II-I

Performances

Performance characteristics of tension resistance under fire exposure

Annex C 5

Appendix 16/ 22

Table C6.1: Performance characteristics of shear resistance under fire exposure

| Anchor type | R30 | | R60 | |
|---|--------------------------|----------------------------|--------------------------|----------------------------|
| | $V_{Rk,s,fi,30}$ [kN] | $M^0_{Rk,s,fi,30}$ [Nm] | $V_{Rk,s,fi,60}$ [kN] | $M^0_{Rk,s,fi,60}$ [Nm] |
| FH II 10, FH II 10 R | 0,3 | 0 | 0,3 | 0 |
| FH II 12, FH II 12 R | 2,0 | 2 | 1,3 | 1 |
| FH II 15, FH II 15 R | 3,2 | 4 | 2,3 | 3 |
| FH II 18, FH II 18 R | 4,8 | 7 | 3,9 | 6 |
| FH II 24, FH II 24 R | 8,9 | 19 | 7,3 | 15 |
| FH II 28 | 13,9 | 37 | 11,3 | 30 |
| FH II 32 | 20,0 | 64 | 16,3 | 52 |
| FH II 12/M6 I, 5.8, A50 ¹⁾ | 0,2 | 0 | 0,2 | 0 |
| FH II 12/M6 I R 8.8, A70, A80 ^{1) 2)} | 0,3 | 0 | 0,3 | 0 |
| FH II 12/M8 I, 5.8, A50 ¹⁾ | 1,3 | 1 | 0,8 | 1 |
| FH II 12/M8-I R 8.8, A70, A80 ^{1) 2)} | 2,0 | 2 | 1,3 | 1 |
| FH II 15/M10 I, 5.8, A50 ¹⁾ | 2,0 | 3 | 1,4 | 2 |
| FH II 15/M10-I R 8.8, A70, A80 ^{1) 2)} | 3,2 | 4 | 2,3 | 3 |
| FH II 15/M12-I, 5.8/A50 ¹⁾ | 3,0 | 4 | 2,4 | 4 |
| FH II 15/M12-I R 8.8, A70, A80 ^{1) 2)} | 4,8 | 7 | 3,9 | 6 |

| Anchor type | R90 | | R120 | |
|---|--------------------------|----------------------------|---------------------------|-----------------------------|
| | $V_{Rk,s,fi,90}$ [kN] | $M^0_{Rk,s,fi,90}$ [Nm] | $V_{Rk,s,fi,120}$ [kN] | $M^0_{Rk,s,fi,120}$ [Nm] |
| FH II 10, FH II 10 R | 0,2 | 0 | 0,1 | 0 |
| FH II 12, FH II 12 R | 0,6 | 1 | 0,2 | 0 |
| FH II 15, FH II 15 R | 1,4 | 2 | 1,0 | 1 |
| FH II 18, FH II 18 R | 3,0 | 5 | 2,6 | 4 |
| FH II 24, FH II 24 R | 5,6 | 12 | 4,8 | 10 |
| FH II 28 | 8,8 | 23 | 7,5 | 20 |
| FH II 32 | 12,6 | 40 | 10,8 | 34 |
| FH II 12/M6-I, 5.8, A50 ¹⁾ | 0,1 | 0 | 0,1 | 0 |
| FH II 12/M6-I R 8.8, A70, A80 ^{1) 2)} | 0,2 | 0 | 0,1 | 0 |
| FH II 12/M8-I, 5.8, A50 ¹⁾ | 0,4 | 1 | 0,1 | 0 |
| FH II 12/M8-I R 8.8, A70, A80 ^{1) 2)} | 0,6 | 1 | 0,2 | 0 |
| FH II 15/M10 I, 5.8, A50 ¹⁾ | 0,9 | 2 | 0,6 | 1 |
| FH II 15/M10-I R 8.8, A70, A80 ^{1) 2)} | 1,4 | 3 | 1,0 | 1 |
| FH II 15/M12 I, 5.8/A50 ¹⁾ | 1,9 | 4 | 1,6 | 3 |
| FH II 15/M12-I R 8.8, A70, A80 ^{1) 2)} | 3,0 | 6 | 2,6 | 4 |

¹⁾ Intermediate values by linear interpolation

²⁾ In combination with screw / threaded rod strength class 8.8, A70, A80

Table C6.2: Minimum spacings and minimum edge distances of anchors under fire exposure for tension and shear loads

| Anchor type | FH II 10 | FH II 12 FH II 12-I | FH II 15 FH II 15-I | FH II 18 | FH II 24 | FH II 28 | FH II 32 |
|---|---|------------------------|------------------------|----------|----------|----------|----------|
| Spacing $\frac{S_{cr,N,fi}}{S_{min,fi}}$ | 4x h _{ef} | | | | | | |
| | 40 | 50 | 60 | 70 | 80 | 100 | 120 |
| Edge distance $\frac{C_{cr,N,fi}}{C_{min,fi}}$ [mm] | 2 x h _{ef} | | | | | | |
| | C _{min,fi} = 2 x h _{ef} , for fire exposure from more than one side C _{min,fi} ≥ 300 mm | | | | | | |

fischer High-Performance Anchor FH II, FH II-I

Performances

Performance characteristics of shear resistance under fire exposure

Minimum spacings and minimum edge distances of anchors under fire exposure

Annex C 6

Table C7.1: Minimum thickness of concrete member, minimum spacing and minimum edge distances
FH II, FH II R

| Anchor type FH II-S, -SK, -B, -H and FH II-S R, -SK R, -B R, -H R | | FH II 10 | FH II 12 | FH II 15 | FH II 18 | FH II 24 | FH II 28 | FH II 32 |
|--|-------------------|---------------------|---------------------|---------------------|---------------------|---------------------|---------------------|---------------------|
| Minimum thickness of concrete member | h_{min} [mm] | 80 | 120 | 140 | 160 | 200 | 250 | 300 |
| Minimum spacing, cracked concrete | s_{min} | 40 | 50 | 60 | 70 | 80 | 100 | 120 |
| | for $c \geq$ [mm] | 40 | 80 | 120 | 140 | 180 | 200 | 260 |
| Minimum edge distance, cracked concrete | c_{min} | 40 | 50 | 60 | 70 | 80 | 100 | 120 |
| | for $s \geq$ | 40 | 80 | 120 | 160 | 200 | 220 | 280 |
| Minimum spacing, uncracked concrete | s_{min} | 40 | 60 | 70 | 80 | 100 | 120 | 160 |
| | for $c \geq$ [mm] | 70 | 100 | 100 | 160 | 200 | 220 | 360 |
| Minimum edge distance, uncracked concrete | c_{min} | 40 | 60 | 70 | 80 | 100 | 120 | 180 |
| | for $s \geq$ | 70 | 100 | 140 | 200 | 220 | 240 | 380 |

Intermediate values may be calculated by linear interpolation

Table C7.2: Minimum thickness of concrete member, minimum spacing and minimum edge distances
FH II-I, FH II-I R

| Anchor type FH II-I and FH II-I R | | FH II 12/M6 I FH II 12/M8 I | FH II 15/M10 I FH II 15/M12 I |
|--|-------------------|--|--|
| Minimum thickness of concrete member | h_{min} [mm] | 125 | 150 |
| Minimum spacing, cracked concrete | s_{min} | 50 | 60 |
| | for $c \geq$ [mm] | 80 | 120 |
| Minimum edge distance, cracked concrete | c_{min} | 50 | 60 |
| | for $s \geq$ | 80 | 120 |
| Minimum spacing, uncracked concrete | s_{min} | 60 | 70 |
| | for $c \geq$ [mm] | 100 | 100 |
| Minimum edge distance, uncracked concrete | c_{min} | 60 | 70 |
| | for $s \geq$ | 100 | 140 |

Intermediate values may be calculated by linear interpolation.

fischer High-Performance Anchor FH II, FH II-I

Performances

Minimum thickness of concrete member, minimum spacing and minimum edge distances

Annex C 7

Table C8.1: Performance characteristics of **tension and shear resistance** for **seismic performance category C1** for FH II-S, -SK, -B, -H and FH II-S R, -SK R, -B R, -H R

| Anchor type FH II-S, -SK, -B, -H and FH II-S R, -SK R, -B R, -H R | | FH II 12 | FH II 15 | FH II 18 | FH II 24 | FH II 28 | FH II 32 | | |
|---|---------------------------|---------------------------|-----------|-----------|----------|----------|----------|-------|--|
| Steel failure | | | | | | | | | |
| Characteristic resistance of tension load C1 | FH II-S, -B | | 29,3 | 46,4 | 67,4 | 125,3 | 195,8 | 282,0 | |
| | FH II-H, -H R, -B R | $N_{Rk,s,C1}$ [kN] | 29,3 | 46,4 | 67,4 | 125,3 | 3) | | |
| | FH II-SK | | 29,3 | 46,4 | 67,4 | 3) | | | |
| | Partial factor | $\gamma_{Ms,C1}^{1)}$ [-] | 1,5 | | | | | | |
| | FH II-S R | $N_{Rk,s,C1}$ [kN] | 29,3 | 46,4 | 67,4 | 125,3 | 3) | | |
| | FH II-SK R | | 29,3 | 46,4 | 67,4 | 3) | | | |
| | Partial factor | $\gamma_{Ms,C1}^{1)}$ [-] | 1,6 | | | | | | |
| Pullout failure | | | | | | | | | |
| Characteristic resistance of tension load in cracked concrete C1 | | $N_{Rk,p,C1}$ [kN] | 12,0 | 16,0 | 25,0 | 36,0 | 50,3 | 66,1 | |
| | | $\gamma_{Mp,C1}^{1)}$ [-] | 1,5 | | | | | | |
| Steel failure without lever arm | | | | | | | | | |
| Characteristic resistance of shear load C1 | | | | | | | | | |
| FH II-S | | | 25,0 | 41,0 | 60,0 | 123,0 | 141,0 | 200,0 | |
| FH II-B | $V_{Rk,s,C1}$ [kN] | | 17,0 | 30,0 | 46,0 | 103,0 | 117,0 | 169,0 | |
| FH II-H | | | 17,0 | 30,0 | 46,0 | 103,0 | | | |
| FH II-SK | $t_{fix}^{2)}$ [mm] | | ≥ 10 | ≥ 15 | | 3) | | | |
| | $V_{Rk,s,C}$ [kN] | | 25,0 | 41,0 | 60,0 | | | | |
| | $t_{fix}^{2)}$ [mm] | | < 10 | < 15 | | | | | |
| | $V_{Rk,s,C}$ [kN] | | 11,0 | 16,0 | 27,0 | | | | |
| Partial factor | $\gamma_{Ms,C1}^{1)}$ [-] | 1,25 | | | | | | | |
| FH II-S R | $V_{Rk,s,C1}$ [kN] | | 25,0 | 41,0 | 60,0 | 123,0 | - | | |
| Partial factor | $\gamma_{Ms,C1}^{1)}$ [-] | 1,33 | | | | | | | |
| FH II-B R, -H R | $V_{Rk,s,C1}$ [kN] | | 17,0 | 30,0 | 46,0 | 103,0 | - | | |
| Partial factor | $\gamma_{Ms,C1}^{1)}$ [-] | 1,25 | | | | | | | |
| FH II-SK R | $t_{fix}^{2)}$ [mm] | | ≥ 10 | ≥ 15 | | 3) | | | |
| | $V_{Rk,s,C1}$ [kN] | | 25,0 | 41,0 | 60,0 | | | | |
| | $t_{fix}^{2)}$ [mm] | | < 10 | < 15 | | | | | |
| | $V_{Rk,s,C1}$ [kN] | | 11,0 | 16,0 | 27,0 | | | | |
| Partial factor | $\gamma_{Ms,C1}^{1)}$ [-] | 1,33 | | | | | | | |
| Factor for annular gap | α_{gap} | 0,50 | | | | | | | |

1) In absence of other national regulations

2) The thickness of the fixture has influence to the characteristic resistance for shear loads, steel failure without lever arm

3) No performance assessed

fischer High-Performance Anchor FH II, FH II-I

Performances

Performance characteristics of tension and shear resistance for seismic performance category C1

Annex C 8

Appendix 19/ 22

Table C9.1: Performance characteristics of tension and shear resistance for seismic performance category C2 for FH II-S, -SK, -B, -H and FH II-S R, -SK R, -B R, -H R

| Anchor type FH II-S, -SK, -B, -H and FH II-S R, -SK R, -B R, -H R | | | | FH II 12 | FH II 15 | FH II 18 | FH II 24 | FH II 28 | FH II 32 |
|---|-----------------------|-----------------------|------|-----------|-----------|----------|----------|----------|----------|
| Steel failure | | | | | | | | | |
| Characteristic resistance of tension load C2 | FH II-S, -B | | | 29,3 | 46,4 | 67,4 | 125,3 | 195,8 | |
| | FH II-H, -H R, -B R | $N_{Rk,s,C2}$ | [kN] | 29,3 | 46,4 | 67,4 | 125,3 | 3) | |
| | FH II-SK | | | 29,3 | 46,4 | 67,4 | 3) | | |
| | Partial factor | $\gamma_{Ms,C2}^{1)}$ | [-] | 1,5 | | | | | |
| | FH II-S R | | | 29,3 | 46,4 | 67,4 | 125,3 | 3) | |
| | FH II-SK R | $N_{Rk,s,C2}$ | [kN] | 29,3 | 46,4 | 67,4 | 3) | | |
| | Partial factor | $\gamma_{Ms,C2}^{1)}$ | [-] | 1,6 | | | | | |
| Pullout failure | | | | | | | | | |
| Characteristic resistance of tension load in cracked concrete C2 | | $N_{Rk,p,C2}$ | [kN] | 6,2 | 11,3 | 21,8 | 43,0 | 65,9 | |
| | | $\gamma_{Mp,C2}^{1)}$ | [-] | 1,5 | | | | | |
| Steel failure without lever arm | | | | | | | | | |
| Characteristic resistance of shear load C2 | | | | | | | | | |
| FH II-S | | | | 14,7 | 28,9 | 41,0 | 100,7 | | |
| FH II-B | $V_{Rk,s,C2}$ | [kN] | | 9,8 | 20,9 | 34,1 | 61,9 | 67,2 | |
| FH II-H | | | | 9,8 | 20,9 | 34,1 | 61,9 | 3) | |
| FH II-SK | $t_{fix}^{2)}$ | [mm] | | ≥ 10 | ≥ 15 | | 3) | | |
| | $V_{Rk,s,C2}$ | [kN] | | 14,8 | 23,3 | 33,8 | | | |
| | $t_{fix}^{2)}$ | [mm] | | < 10 | < 15 | | | | |
| | $V_{Rk,s,C2}$ | [kN] | | 6,3 | 9,1 | 15,1 | | | |
| Partial factor | $\gamma_{Ms,C2}^{1)}$ | [-] | 1,25 | | | | | | |
| FH II-S R | $V_{Rk,s,C2}$ | [kN] | | 14,7 | 28,9 | 41,0 | 100,7 | 3) | |
| Partial factor | $\gamma_{Ms,C2}^{1)}$ | [-] | 1,33 | | | | | | |
| FH II-B R, -H R | $V_{Rk,s,C2}$ | [kN] | | 9,8 | 20,9 | 34,1 | 61,9 | 3) | |
| Partial factor | $\gamma_{Ms,C2}^{1)}$ | [-] | 1,25 | | | | | | |
| FH II-SK R | $t_{fix}^{2)}$ | [mm] | | ≥ 10 | ≥ 15 | | 3) | | |
| | $V_{Rk,s,C2}$ | [kN] | | 14,8 | 23,3 | 33,8 | | | |
| | $t_{fix}^{2)}$ | [mm] | | < 10 | < 15 | | | | |
| | $V_{Rk,s,C2}$ | [kN] | | 6,3 | 9,1 | 15,1 | | | |
| Partial factor | $\gamma_{Ms,C2}^{1)}$ | [-] | 1,33 | | | | | | |
| Factor for annular gap | α_{gap} | | | 0,50 | | | | | |

1) In absence of other national regulations

2) The thickness of the fixture has influence to the characteristic resistance for shear loads, steel failure without lever arm

3) No performance assessed

fischer High-Performance Anchor FH II, FH II-I

Performances

Performance characteristics of tension and shear resistance for seismic performance category C2

Annex C 9

Appendix 20/ 22

Table C10.1: Displacements under static and quasi static **tension loads** for FH II and FH II R

| Anchor type FH II-S, -SK, -B, -H and FH II-S R, -SK R, -B R, -H R | | FH II 10 | FH II 12 | FH II 15 | FH II 18 | FH II 24 | FH II 28 | FH II 32 |
|---|---|----------|----------|----------|----------|----------|----------|----------|
| Tension load cracked concrete | N [kN] | 3,6 | 5,7 | 7,6 | 11,9 | 17,1 | 24,0 | 31,5 |
| Corresponding displacements | $\frac{\delta_{N0}}{\delta_{N\infty}}$ [mm] | 1,0 | 1,0 | 1,0 | 1,0 | 1,0 | 0,7 | 0,7 |
| | | 1,7 | 1,6 | 1,6 | 1,6 | 1,8 | 1,3 | 1,1 |
| Tension load uncracked concrete | N [kN] | 6,0 | 11,2 | 14,1 | 17,2 | 24,0 | 33,6 | 44,2 |
| Corresponding displacements | $\frac{\delta_{N0}}{\delta_{N\infty}}$ [mm] | 0,6 | 1,0 | 1,0 | 1,0 | 1,0 | 0,3 | 0,3 |
| | | 1,7 | 1,6 | 1,6 | 1,6 | 1,8 | 1,3 | 1,1 |

Table C10.2: Displacements under static and quasi static **tension loads** for FH II-I and FH II-I R

| Anchor type FH II-I and FH II-I R | | FH II 12/M6 I FH II 12/M8 I | FH II 15/M10 I FH II 15/M12 I |
|-----------------------------------|---|--------------------------------|----------------------------------|
| Tension load cracked concrete | N [kN] | 4,3 | 5,7 |
| Tension load uncracked concrete | | 9,5 | 14,1 |
| Corresponding displacements | $\frac{\delta_{N0}}{\delta_{N\infty}}$ [mm] | 1,7 | 1,9 |
| | | 2,2 | 2,9 |

Table C10.3: Displacements under static and quasi static **shear loads** for FH II-S and FH II-SK

| Anchor type FH II-S and FH II-SK | | FH II 10 | FH II 12 | FH II 15 | FH II 18 | FH II 24 | FH II 28 | FH II 32 |
|--|---|----------|----------|----------|----------|----------|----------|----------|
| Shear load in cracked and uncracked concrete | V [kN] | 10,3 | 18,9 | 33,7 | 43,4 | 83,4 | 99,4 | 124,0 |
| Corresponding displacements | $\frac{\delta_{V0}}{\delta_{V\infty}}$ [mm] | 2,4 | 2,7 | 4,4 | 5,0 | 7,0 | 6,0 | 8,0 |
| | | 3,6 | 4,1 | 6,6 | 7,5 | 10,5 | 9,0 | 12,0 |

Table C10.4: Displacements under static and quasi static **shear loads** for FH II-B and FH II-H

| Anchor type FH II-B and FH II-H | | FH II 10 | FH II 12 | FH II 15 | FH II 18 | FH II 24 | FH II 28 | FH II 32 |
|--|---|----------|----------|----------|----------|----------|----------|----------|
| Shear load in cracked and uncracked concrete | V [kN] | 8,9 | 15,4 | 23,4 | 35,4 | 68,0 | 83,4 | 96,6 |
| Corresponding displacements | $\frac{\delta_{V0}}{\delta_{V\infty}}$ [mm] | 2,2 | 2,3 | 3,0 | 5,0 | 7,0 | 5,0 | 5,0 |
| | | 3,3 | 3,5 | 4,5 | 7,5 | 10,5 | 7,5 | 7,5 |

fischer High-Performance Anchor FH II, FH II-I

Performances
Displacements under tension and shear loads

Annex C 10

Appendix 21/ 22

Table C11.1: Displacements under static and quasi static **shear loads** for FH II-S R, FH II-SK R, FH II-B R and FH II-H R

| Anchor type FH II-S R, -SK R, -B R, -H R | | FH II 10 | FH II 12 | FH II 15 | FH II 18 | FH II 24 |
|--|---|-------------|-------------|-------------|-------------|-------------|
| Shear load in cracked and uncracked concrete | V [kN] | 10,3 | 16,0 | 24,6 | 37,7 | 68,0 |
| Corresponding displacements | $\frac{\delta_{V0}}{\delta_{V\infty}}$ [mm] | 3,5 | 3,5 | 3,7 | 5,7 | 9,0 |
| | | 5,3 | 5,3 | 5,6 | 8,6 | 13,5 |

Table C11.2: Displacements under static and quasi static **shear loads** for FH II-I and FH II-I R

| Anchor type: FH II-I and FH II-I R | | FH II 12/M6 I | FH II 12/M8 I | FH II 15/M10 I | FH II 15/M12 I |
|--|---|------------------|------------------|-------------------|-------------------|
| Shear load in cracked and uncracked concrete | V [kN] | 4,6 | 8,3 | 13,3 | 13,7 |
| Corresponding displacements | $\frac{\delta_{V0}}{\delta_{V\infty}}$ [mm] | 2,6 | 2,6 | 2,2 | 2,2 |
| | | 3,9 | 3,9 | 3,3 | 3,3 |

Table C11.3: Displacements under **tension loads** for **seismic performance category C2** for FH II and FH II R

| Anchor type FH II-S, -SK, -B, -H and FH II-S R, -SK R, -B R, -H R | | FH II 12 | FH II 15 | FH II 18 | FH II 24 | FH II 28 | FH II 32 |
|---|------|-------------|-------------|-------------|-------------|-------------|-------------|
| Displacement DLS $\delta_{N,C2 (DLS)}$ | [mm] | 1,55 | 2,63 | 2,04 | 4,26 | 3,06 | |
| Displacement ULS $\delta_{N,C2 (ULS)}$ | | 8,71 | 11,07 | 7,30 | 11,70 | 11,44 | |

Table C11.4: Displacements under **shear loads** for **seismic performance category C2** for FH II and FH II R

| Anchor type FH II-S, -SK and FH II-S R, -SK R | | FH II 12 | FH II 15 | FH II 18 | FH II 24 | FH II 28 | FH II 32 |
|---|------|-------------|-------------|-------------|-------------|-------------|-------------|
| Displacement DLS $\delta_{V,C2 (DLS)}$ | [mm] | 3,53 | 4,18 | 4,67 | 5,59 | 4,79 | |
| Displacement ULS $\delta_{V,C2 (ULS)}$ | | 6,62 | 7,38 | 9,03 | 14,09 | 9,95 | |

| Anchor type FH II-B, -H and FH II-B R, -H R | | FH II 12 | FH II 15 | FH II 18 | FH II 24 | FH II 28 | FH II 32 |
|---|------|-------------|-------------|-------------|-------------|-------------|-------------|
| Displacement DLS $\delta_{V,C2 (DLS)}$ | [mm] | 3,42 | 4,26 | 4,29 | 4,79 | | |
| Displacement ULS $\delta_{V,C2 (ULS)}$ | | 5,26 | 6,66 | 7,95 | 7,69 | 9,95 | |

fischer High-Performance Anchor FH II, FH II-I

Performances
Displacements under tension and shear loads

Annex C 11

Appendix 22/ 22