

## DECLARAÇÃO DE DESEMPENHO

### DoP 0334

para fischer Anchor bolt FAZ II Plus, FAZ II Plus R, FAZ II Plus HCR (Ancoragem metálica para utilização em betão)

PT

1. Código de identificação único do produto-tipo: **DoP 0334**
2. Utilização(ões) prevista(s): **Fixação pós-instalada em betão fissurado ou não fissurado, ver anexos, especialmente anexos B1 - B4.**
3. Fabricante: **fischerwerke GmbH & Co. KG, Klaus-Fischer-Str. 1, 72178 Waldachtal, Alemanha**
4. Representante autorizado: **-**
5. Sistema(s) de avaliação e verificação da regularidade do desempenho (AVCP): **1**
6. Documento de Avaliação Europeu: **EAD 330232-01-0601, Edition 05/2021**  
Avaliação Técnica Europeia: **ETA-19/0520; 2023-05-24**  
Organismo de Avaliação Técnica: **DIBt- Deutsches Institut für Bautechnik**  
Organismo(s) notificado(s): **2873 TU Darmstadt**
7. Desempenho(s) declarado(s):  
**Resistência mecânica e estabilidade (BWR 1)**  
**Características de resistência à tração (para acção estática e quase-estática) Método A:**  
Resistência à rotura do aço: Anexo C1  
Resistência à rotura por arranque: Anexo C1  
Resistência à rotura por cone de betão: Anexo C1  
Robustez: Anexo C1  
Distância mínima ao bordo e espaçamento: Anexos C5, C6  
Distância ao bordo para prevenir rotura por fendilhação: Anexo C1  
  
**Características de resistência ao corte (para acção estática e quase-estática), Método A:**  
Resistência à rotura do aço (corte): Anexo C2  
Resistência do betão ao destacamento: Anexo C2  
  
**Resistência característica para design simplificado:**  
Método B: NPD  
Método C: NPD  
  
**Deslocamentos:**  
Deslocamentos sobre ações estáticas ou quase-estáticas: Anexo C9  
  
**Resistência característica e Deslocamentos para as categorias de performance sísmica C1 e C2:**  
Resistência à tração, deslocamentos, categoria C1: Anexo C7  
Resistência à tração, deslocamentos, categoria C2: Anexos C8, C9  
Resistência ao corte, deslocamentos, categoria C1: Anexo C7  
Resistência ao corte, deslocamentos, categoria C2: Anexos C8, C9  
Factor espaço anular: Anexos C7, C8  
  
**Segurança em caso de incêndio (BWR 2)**  
Reação ao fogo: Classe (A1)  
**Resistência ao fogo:**  
Resistência em caso de incêndio, rotura do aço (tração): Anexo C3  
Resistência em caso de incêndio, rotura por arranque (tração): Anexo C3  
Resistência em caso de incêndio, rotura do aço (corte): Anexos C3, C4  
  
**Durabilidade:**  
Durabilidade: Anexos A4, B1
8. Documentação Técnica Adequada e/ou Documentação Técnica Específica: **-**



O desempenho do produto identificado acima está em conformidade com o conjunto de desempenhos declarados. A presente declaração de desempenho é emitida, em conformidade com o Regulamento (UE) n.º 305/2011, sob a exclusiva responsabilidade do fabricante identificado acima.

Assinado por e em nome do fabricante por:

Dr.-Ing. Oliver Geibig, Diretor Administrativo de Unidades de Negócios e Engenharia  
Tumlingen, 2023-05-31

Jürgen Grün, Diretor Administrativo de Química e Qualidade

Este DoP foi preparado em diferentes línguas. Em caso de litígio sobre a interpretação, a versão em inglês prevalecerá sempre.

O Anexo inclui informações voluntárias e complementares em inglês que excedem os requisitos legais (linguisticamente especificados).

## Specific Part

### 1 Technical description of the product

The fischer Bolt Anchor FAZ II Plus, FAZ II Plus R, FAZ II Plus HCR is an anchor made of galvanized steel (FAZ II Plus), stainless steel (FAZ II Plus R) or high corrosion resistant steel (FAZ II Plus HCR) which is placed into a drilled hole and anchored by torque-controlled expansion.

The product description is given in Annex A.

### 2 Specification of the intended use in accordance with the applicable European Assessment Document

The performances given in Section 3 are only valid if the anchor is used in compliance with the specifications and conditions given in Annex B.

The verifications and assessment methods on which this European Technical Assessment is based lead to the assumption of a working life of the anchor of at least 50 years. The indications given on the working life cannot be interpreted as a guarantee given by the producer, but are to be regarded only as a means for choosing the right products in relation to the expected economically reasonable working life of the works.

### 3 Performance of the product and references to the methods used for its assessment

#### 3.1 Mechanical resistance and stability (BWR 1)

| Essential characteristic   | Performance             |
|--|-------------------------|
| Characteristic resistance to tension load (static and quasi-static loading), Method A    | See Annex C1, C5 and C6 |
| Characteristic resistance to shear load (static and quasi-static loading)                | See Annex C2            |
| Displacements  | See Annex C9            |
| Characteristic resistance and displacements for seismic performance categories C1 and C2 | See Annex C7 to C9      |

#### 3.2 Safety in case of fire (BWR 2)

| Essential characteristic | Performance         |
|--------------------------|---------------------|
| Reaction to fire         | Class A1            |
| Resistance to fire       | See Annex C3 and C4 |

#### 3.3 Aspects of Durability

| Essential characteristic | Performance  |
|--------------------------|--------------|
| Durability               | See Annex B1 |

**4 Assessment and verification of constancy of performance (AVCP) system applied, with reference to its legal base**

In accordance with the European Assessment Document EAD 330232-01-0601 the applicable European legal act is: [96/582/EC].

The system to be applied is: 1

Cone bolt manufactured by cold - forming:

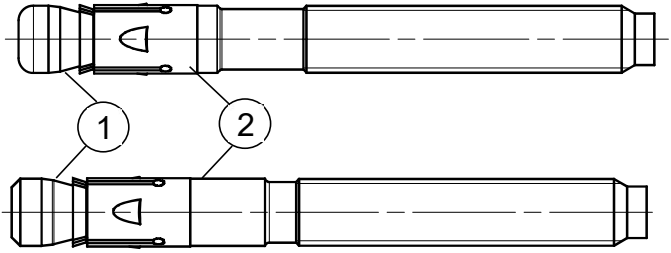

Cone bolt manufactured by turning:

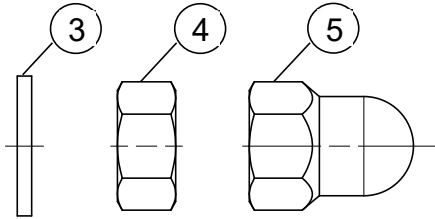

- ① Expansion sleeve
- ② Cone bolt (cold – formed or turned)
- ③ Washer
- ④ Hexagon nut
- ⑤ fischer FAZ II Plus dome nut

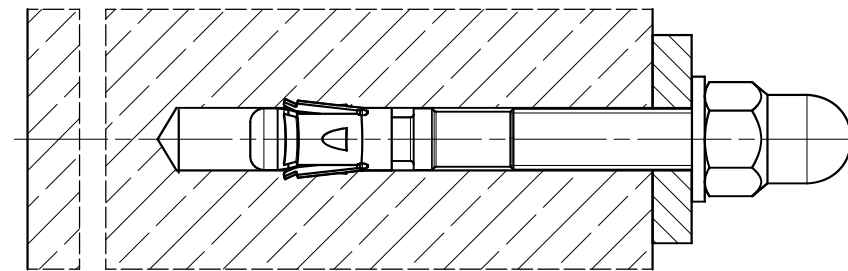
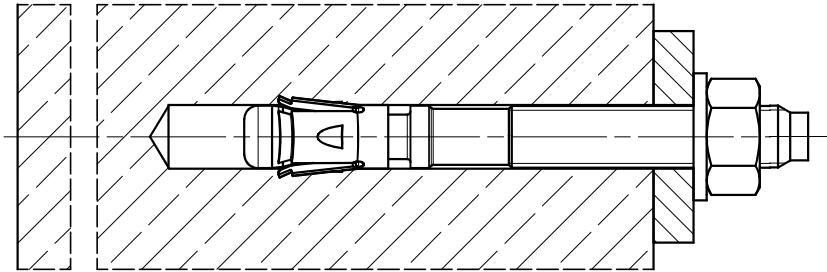

*(Figure not to scale)*

fischer Bolt Anchor FAZ II Plus, FAZ II Plus R,  
FAZ II Plus HCR

**Product description**  
Installed condition

**Annex A1**

Annex 3 / 19

## Product marking and letter-code:

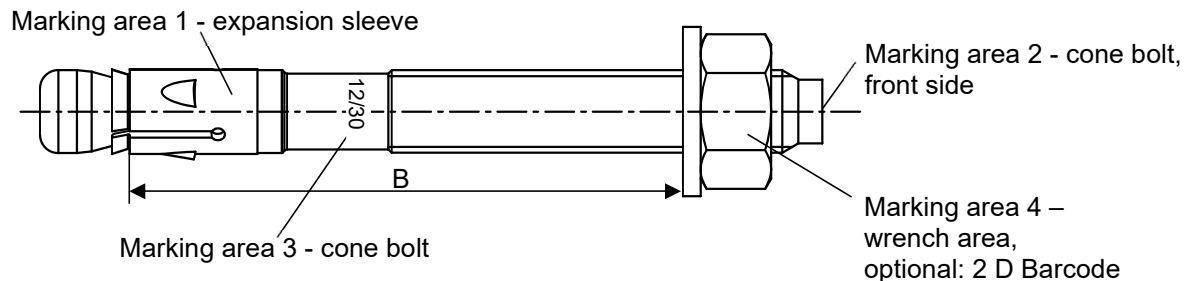

Product marking, example:

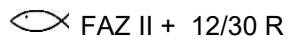

Brand | type of fastener  
placed at marking area 1 or 3

Thread size / max. thickness of the fixture ( $t_{fix}$ )  
identification R or HCR placed at marking area 1 or 3

FAZ II Plus: carbon steel, galvanised  
FAZ II Plus R: stainless steel  
FAZ II Plus HCR: high corrosion resistant steel

**Table A2.1:** Letter - code at marking area 2:

| Marking             | (a) | (b) | (c) | (d) | (A) | (B) | (C) | (D) | (E) | (F) | (G) | (H) | (I) | (K) |
|---------------------|-----|-----|-----|-----|-----|-----|-----|-----|-----|-----|-----|-----|-----|-----|
| Max. $t_{fix}$ [mm] | 5   | 10  | 15  | 20  | 5   | 10  | 15  | 20  | 25  | 30  | 35  | 40  | 45  | 50  |
| $B \geq$ [mm]       | M6  | -   |     |     | 45  | 50  | 55  | 60  | 65  | 70  | 75  | 80  | 85  | 90  |
|                     | M8  | 40  | 45  | -   |     | 50  | 55  | 60  | 65  | 70  | 75  | 80  | 85  | 90  |
|                     | M10 | 45  | 50  | 55  | 60  | 65  | 70  | 75  | 80  | 85  | 90  | 95  | 100 | 105 |
|                     | M12 | 55  | 60  | 65  | 70  | 75  | 80  | 85  | 90  | 95  | 100 | 105 | 110 | 115 |
|                     | M16 | 70  | 75  | 80  | 85  | 90  | 95  | 100 | 105 | 110 | 115 | 120 | 125 | 130 |
|                     | M20 | -   |     |     |     | 105 | 110 | 115 | 120 | 125 | 130 | 135 | 140 | 145 |
|                     | M24 | -   |     |     |     | 130 | 135 | 140 | 145 | 150 | 155 | 160 | 165 | 170 |

| Marking             | (L) | (M) | (N) | (O) | (P) | (R) | (S) | (T) | (U) | (V) | (W) | (X) | (Y) | (Z) |
|---------------------|-----|-----|-----|-----|-----|-----|-----|-----|-----|-----|-----|-----|-----|-----|
| Max. $t_{fix}$ [mm] | 60  | 70  | 80  | 90  | 100 | 120 | 140 | 160 | 180 | 200 | 250 | 300 | 350 | 400 |
| $B \geq$ [mm]       | M6  | 100 | 110 | 120 | 130 | 140 | 160 | 180 | 200 | 220 | 240 | 290 | 340 | 390 |
|                     | M8  | 105 | 115 | 125 | 135 | 145 | 165 | 185 | 205 | 225 | 245 | 295 | 345 | 395 |
|                     | M10 | 120 | 130 | 140 | 150 | 160 | 180 | 200 | 220 | 240 | 260 | 310 | 360 | 410 |
|                     | M12 | 130 | 140 | 150 | 160 | 170 | 190 | 210 | 230 | 250 | 270 | 320 | 370 | 420 |
|                     | M16 | 145 | 155 | 165 | 175 | 185 | 205 | 225 | 245 | 265 | 285 | 335 | 385 | 435 |
|                     | M20 | 160 | 170 | 180 | 190 | 200 | 220 | 240 | 260 | 280 | 300 | 350 | 400 | 450 |
|                     | M24 | 185 | 195 | 205 | 215 | 225 | 245 | 265 | 285 | 305 | 325 | 375 | 425 | 475 |

### Calculation existing $h_{ef}$ for installed fasteners:

$$\text{existing } h_{ef} = B_{(\text{according to table A2.1})} - \text{existing } t_{fix}$$

Thickness of the fixture  $t_{fix}$  including thickness of filling conical washer  $t$  and e.g. thickness of grout layer  $t_{grout}$  or other non-structural layers

(Figure not to scale)

fischer Bolt Anchor FAZ II Plus, FAZ II Plus R,  
FAZ II Plus HCR

**Product description**  
Product marking and letter code

**Annex A2**

Annex 4 / 19

## Product dimensions

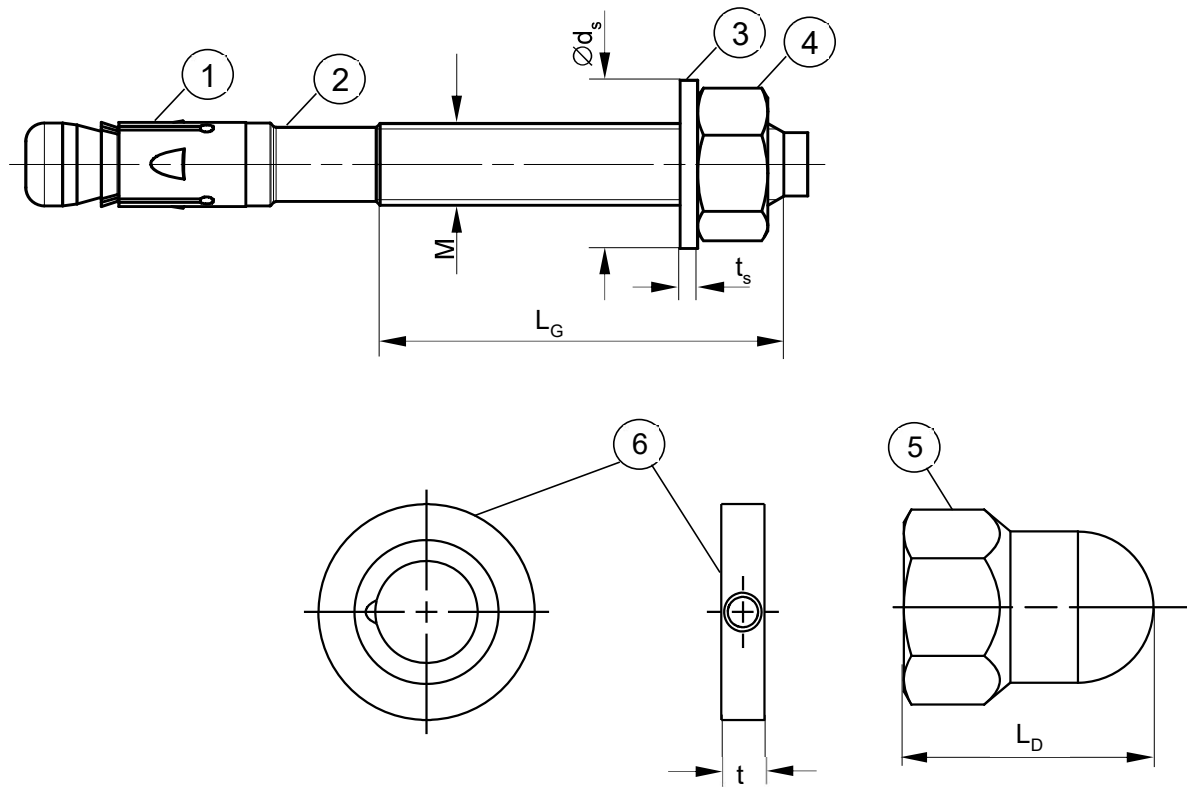

**Table A3.1:** Dimensions [mm]

| Part  | Designation                                |                           | FAZ II Plus, FAZ II Plus R, FAZ II Plus HCR |     |     |     |     |                 |     |
|-------|--|---------------------------|---|-----|-----|-----|-----|-----------------|-----|
|       |  |                           | M6  | M8  | M10 | M12 | M16 | M20             | M24 |
| 1     | Expansion sleeve                           | Sheet thickness           | 0,8   | 1,3 | 1,4 | 1,6 | 2,4 |                 | 3,0 |
| 2     | Cone bolt                                  | Thread size M             | 6   | 8   | 10  | 12  | 16  | 20              | 24  |
|       |  | $L_G$                     | 10  | 19  | 26  | 31  | 40  | 50              | 57  |
| 3     | Washer                                     | $t_s$                     | 1,4   |     | 1,8 | 2,3 | 2,7 |                 | 3,7 |
|       |  | $\varnothing d_s$         | 11  | 15  | 19  | 23  | 29  | 36              | 43  |
| 4 & 5 | Hexagon nut / fischer FAZ II Plus dome nut | Wrench size <sup>1)</sup> | 10  | 13  | 17  | 19  | 24  | 30              | 36  |
| 5     | fischer filling conical washer FFD         | $L_D$                     | - <sup>2)</sup>                             |     | 22  | 27  | 33  | - <sup>2)</sup> |     |
| 6     | fischer filling conical washer FFD         | t                         | 6   |     |     |     | 7   | 8               | 10  |

<sup>1)</sup> Alternatively according to ISO 4032:2013 allowed

<sup>2)</sup> Not part of the assessment

(Figure not to scale)

fischer Bolt Anchor FAZ II Plus, FAZ II Plus R, FAZ II Plus HCR

**Product description**  
Dimensions

**Annex A3**

Annex 5 / 19

**Table A4.1: Materials FAZ II Plus**

| Part  | Designation                                      | Material   |  |   |
|-------|--|--|--|---|
|       |  | FAZ II Plus  | FAZ II Plus R  | FAZ II Plus HCR   |
|       | Steel grade                                      | Steel  | Stainless steel R  | High corrosion resistant steel HCR  |
|       |  | Zinc plated $\geq 5 \mu\text{m}$ ,<br>ISO 4042:2018              | according to EN 10088:2014<br>Corrosion resistance class<br>CRC III according to<br>EN 1993-1-4:2006+A1:2015 | according to EN 10088:2014<br>Corrosion resistance class<br>CRC V according to<br>EN 1993-1-4: 2006+A1:2015 |
| 1     | Expansion sleeve                                 | Cold strip, EN 10139:2016<br>or stainless steel<br>EN 10088:2014 | Stainless steel<br>EN 10088:2014   |   |
| 2     | Cone bolt  | Cold form steel or free<br>cutting steel                         | Stainless steel<br>EN 10088:2014   | High corrosion resistant<br>steel EN 10088:2014   |
| 3     | Washer   | Cold strip, EN 10139:2016  |  |   |
| 4 / 5 | Hexagon nut /<br>fischer FAZ II Plus<br>dome nut | Steel, property class min. 8,<br>EN ISO 898-2:2012               | Stainless steel<br>EN 10088:2014;<br>ISO 3506-2:2020; property<br>class – min. 70                            | High corrosion resistant<br>steel EN 10088:2014;<br>ISO 3506-2:2020; property<br>class – min. 70            |
| 6     | fischer filling<br>conical washer<br>FFD         | Cold form steel or free<br>cutting steel                         | Stainless steel<br>EN 10088:2014   | High corrosion resistant<br>steel EN 10088:2014   |

fischer Bolt Anchor FAZ II Plus, FAZ II Plus R,  
FAZ II Plus HCR

**Product description**  
Materials



**Annex A4**

Annex 6 / 19



## Specifications of intended use

### Fastenings subject to:

| Size  | FAZ II Plus, FAZ II Plus R, FAZ II Plus HCR |                 |                                     |     |     |     |     |
|---|---|-----------------|-------------------------------------|-----|-----|-----|-----|
|   | M6  | M8              | M10                                 | M12 | M16 | M20 | M24 |
| Hammer drilling with standard drill bit                        |   |                 |                                     | ✓   |     |     |     |
| Hammer drilling with hollow drill bit with automatic cleaning  | - <sup>1)</sup>                             |                 |                                     |     | ✓   |     |     |
| Diamond drilling   | - <sup>1)</sup>                             | ✓               | (for non seismic applications only) |     |     |     |     |
| Static and quasi-static loads   |   |                 |                                     |     |     |     |     |
| Cracked and uncracked concrete  |   |                 |                                     | ✓   |     |     |     |
| Fire exposure   |   |                 |                                     |     |     |     |     |
| Seismic performance category  | C1  | - <sup>1)</sup> |                                     |     | ✓   |     |     |
|   | C2  | - <sup>1)</sup> |                                     |     |     | ✓   |     |

<sup>1)</sup> No performance assessed

#### Base materials:

- Compacted reinforced and unreinforced normal weight concrete without fibres (cracked or uncracked) according to EN 206-1:2013+A2:2021
- Strength classes C20/25 to C50/60 according to EN 206:2013+A2:2021

#### Use conditions (Environmental conditions):

- Structures subject to dry internal conditions (FAZ II Plus, FAZ II Plus R, FAZ II Plus HCR)
- For all other conditions according to EN 1993-1-4:2006 + A1:2015 corresponding to corrosion resistance class
  - CRC III: for FAZ II Plus R
  - CRC V: for FAZ II Plus HCR

#### Design:

- Fastenings are to be designed under the responsibility of an engineer experienced in fastenings and concrete work
- Verifiable calculation notes and drawings are to be prepared taking account of the loads to be anchored. The position of the fastener is indicated on the design drawings (e.g. position of the fastener relative to reinforcement or to supports, etc.)
- Fastenings in stand-off installation or with a grout layer under seismic action are not covered
- In case of seismic applications the fastener shall be positioned outside of critical regions (e.g. plastic hinges) of the concrete structure
- Design of fastenings according to EN 1992-4:2018 and EOTA Technical Report TR 055:2018

fischer Bolt Anchor FAZ II Plus, FAZ II Plus R, FAZ II Plus HCR

**Intended Use**  
Specifications

**Annex B1**

Annex 7 / 19

**Table B2.1: Installation parameters**

| Size  | FAZ II Plus, FAZ II Plus R, FAZ II Plus HCR |       |               |        |                |                 |       |
|---|---|-------|---------------|--------|----------------|-----------------|-------|
|   | M6  | M8    | M10           | M12    | M16            | M20             | M24   |
| Nominal drill hole diameter $d_0 =$   | 6   | 8     | 10            | 12     | 16             | 20              | 24    |
| Maximum bit diameter with hammer or hollow drilling $d_{cut,max}$ [mm]  | 6,40  | 8,45  | 10,45         | 12,5   | 16,5           | 20,55           | 24,55 |
| Maximum bit diameter with diamond drilling  | - <sup>1)</sup>                             | 8,15  |               | 12,25  | 16,45          | 20,50           | 24,40 |
| Effective embedment depth $h_{ef} \geq$   | 40-80                                       | 35-90 | 40-100        | 50-125 | 65-160         | 100-180         | 125   |
| Length from $h_{ef}$ to end of cone bolt $L$  | 6,5   | 9,5   | 11,5          | 13,5   | 17,5           | 20,0            | 23,5  |
| Overall fastener embedment depth in the concrete $h_{nom} \geq$ [mm]  | $h_{ef} + L$                                |       |               |        |                |                 |       |
| Depth of drill hole to deepest point $h_1^{2)} \geq$  | $h_{nom} + 3$                               |       | $h_{nom} + 5$ |        | $h_{nom} + 10$ |                 |       |
| Diameter of clearance hole in the fixture $d_f \leq$ [mm]   | 7   | 9     | 12            | 14     | 18             | 22              | 26    |
| Required setting torque $T_{inst} =$ [Nm]   | 8   | 20    | 45            | 60     | 110            | 200             | 270   |
| Excess length after hammering-in the cone bolt (for fischer dome nut applications according to Annex B4) $O =$ [mm] | - <sup>1)</sup>                             |       | 12            | 16     | 20             | - <sup>1)</sup> |       |

<sup>1)</sup> Not part of the assessment

<sup>2)</sup> For the application without drill hole cleaning:  $h_{1,nc} = h_1 + 15 \text{ mm}$

Setting gauge FAZ II Plus SL-H for fastener with fischer FAZ II Plus dome nut:

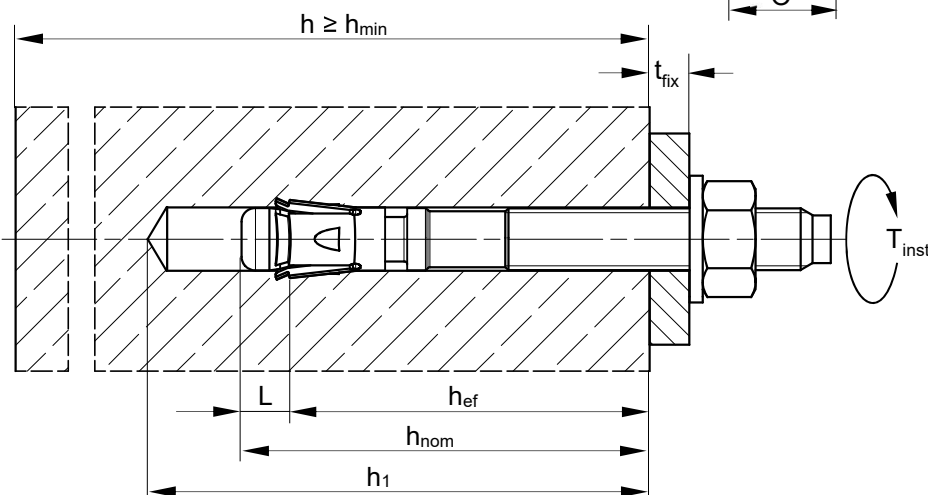
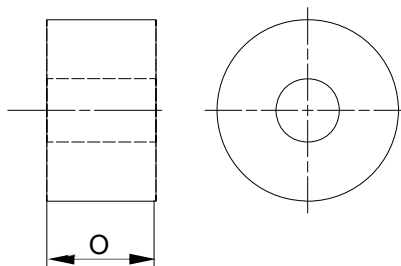

$h_{ef}$  = Effective embedment depth  
 $h_{nom}$  = Overall fastener embedment depth in the concrete  
 $h_1$  = Depth of drill hole to deepest point  
 $h_{1,nc}$  = Depth of drill hole to deepest point without cleaning  
 $L$  = Length from  $h_{ef}$  to end of cone bolt

$h$  = Thickness of the concrete member  
 $h_{min}$  = Minimum thickness of concrete member  
 $t_{fix}$  = Thickness of the fixture  
 $O$  = Length of setting gauge  
 $T_{inst}$  = Required setting torque

fischer Bolt Anchor FAZ II Plus, FAZ II Plus R, FAZ II Plus HCR

**Intended Use**  
Installation parameters

**Annex B2**







Annex 8 / 19

## Installation instructions:

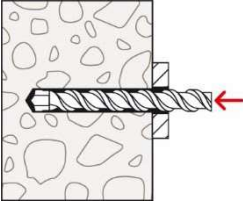
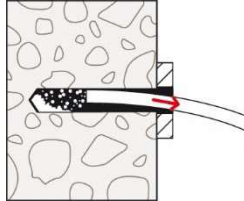
- Fastener installation carried out by appropriately qualified personnel according to the design drawings and under the supervision of the person responsible for technical matters on the site
- Use of the fastener only as supplied by the manufacturer without exchanging the components of the fastener  
Exception: fischer FAZ II Plus dome nut
- Hammer, hollow or diamond drilling according to Annex B1 + B2
- Drill hole created perpendicular +/- 5° to concrete surface, positioning without damaging the reinforcement
- In case of aborted hole: new drilling at a minimum distance twice the depth of the aborted drill hole or smaller distance if the aborted drill hole is filled with high strength mortar and if under shear or oblique tension load it is not in the direction of load application

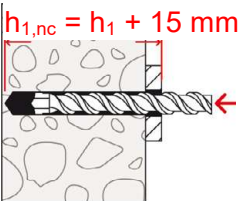
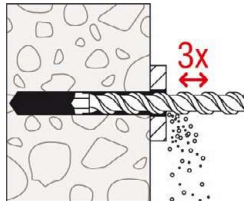
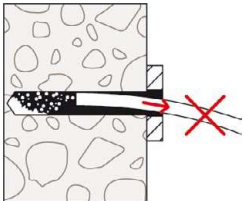
## Installation instructions: Drilling and cleaning the hole

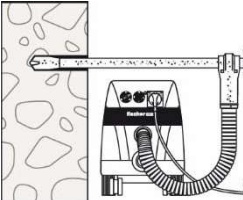
### Types of drills and cleaning

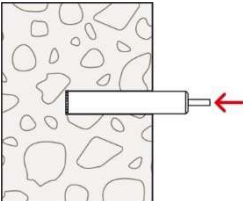
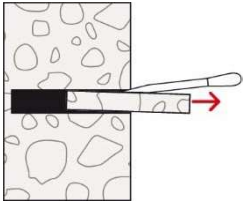
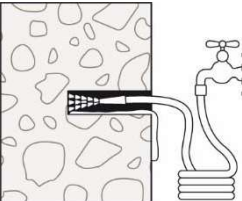
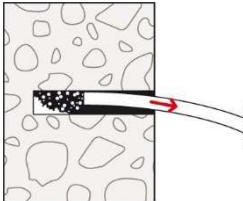
|   |   |   |  |
|---|---|---|--|
| <p>Hammer drill<br/>(e.g. fischer Quattric II)<br/>with cleaning</p>    |    |  <p>1: Drill the hole</p>  |  <p>2: Clean the hole</p> <p>Continue with step 5</p>  |
| <p>Hammer drill<br/>(e.g. fischer Quattric II)<br/>without cleaning</p> |    |  <p>1: Drill the hole</p> <p><math>h_{1,nc} = h_1 + 15 \text{ mm}</math></p>  |  <p>2: When <math>h_{1,nc}</math> is reached:<br/>Pull out drill 3 x</p>  <p>Cleaning not necessary;<br/>Continue with step 5</p>   |
| <p>Hollow drill<br/>(e.g. fischer FHD)</p>                              |  |  <p>1: Drill the hole with<br/>automatic cleaning<br/>(e.g. fischer FVC)</p> |  <p>Cleaning obsolete</p> <p>Continue with step 5</p>  |
| <p>Diamond drill,<br/>for non seismic<br/>applications<br/>only</p>     |  |  <p>1: Drill the hole</p>  |  <p>2: Break the drill<br/>core and remove<br/>it</p>  <p>3: Flush the drill<br/>hole, until clear<br/>water emerges<br/>from the drill hole</p>  <p>4: Clean the hole</p> |

fischer Bolt Anchor FAZ II Plus, FAZ II Plus R,  
FAZ II Plus HCR

**Intended Use**  
Installation instructions

**Annex B3**

Annex 9 / 19

# Installation instructions: Installation of the fastener

## HEXAGON NUT:

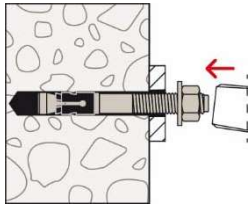

5.a: Set the fastener e.g. with hammer



5.b: Set the fastener e.g. fischer FA-ST II

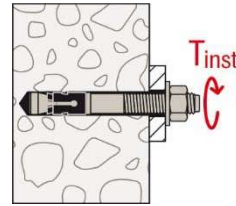

6: Apply  $T_{inst}$

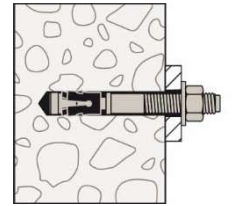

7: Installed fastener

## fischer FAZ II Plus DOME NUT:

Option 1: Push through installation with setting gauge SL-H:

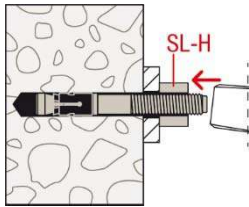

5.1: Set the fastener through the setting gauge and fixture

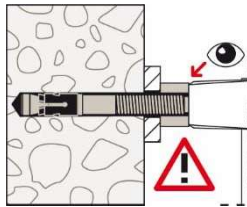

5.2: Check offset

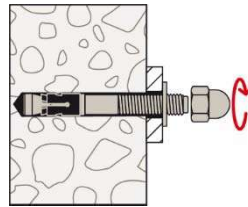

5.3: Turn on the fischer FAZ II Plus dome nut

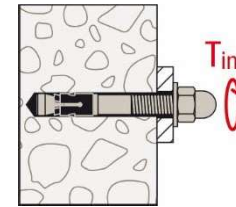

6: Apply  $T_{inst}$

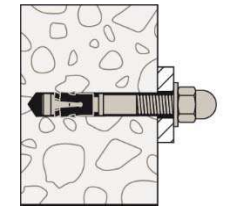

7: Installed fastener

Option 2: Push through installation with hexagon nut:

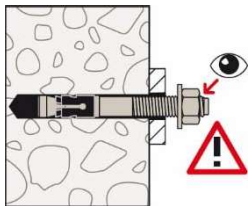

5.1: Check setting position: Visible one turn of a thread

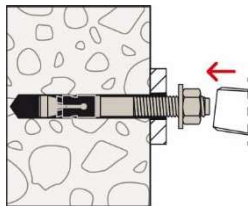

5.2: Set the fastener

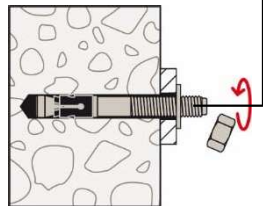

5.3: Remove nut

## fischer Filling conical washer FFD optional for seismic C2 application or minimising the annular gap:

Optional The gap between bolt and fixture may be filled with mortar (compressive strength  $\geq 50 \text{ N/mm}^2$  e.g. fischer FIS SB) after last step (for eliminating the annular gap). The FFD is additional to the standard washer. The thickness of the FFD must be considered for definition of  $t_{fix}$ . Countersunk of the FFD in direction to the anchor plate. Installation with hexagon nut or dome nut is permitted.

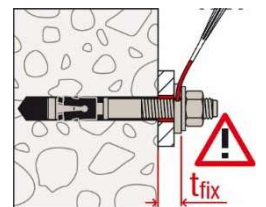
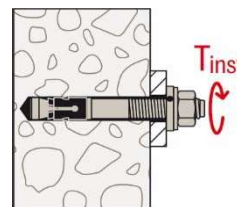
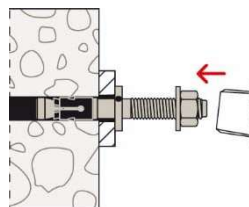
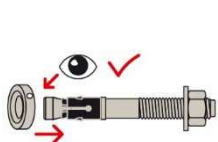

fischer Bolt Anchor FAZ II Plus, FAZ II Plus R, FAZ II Plus HCR

**Intended Use**  
Installation instructions

**Annex B4**

Annex 10 / 19

**Table C1.1: Characteristic values of tension resistance under static and quasi-static action**

| Size   |                          | FAZ II Plus, FAZ II Plus R, FAZ II Plus HCR |                                      |                         |                    |                 |        |        |         |                  |                    |
|--|--------------------------|---|--------------------------------------|-------------------------|--------------------|-----------------|--------|--------|---------|------------------|--------------------|
|  |                          | M6  | M8                                   | M10                     | M12                | M16             | M20    | M24    |         |                  |                    |
| <b>Steel failure</b>   |                          |   |                                      |                         |                    |                 |        |        |         |                  |                    |
| Characteristic resistance                                    | FAZ II Plus              | $N_{Rk,s}$ [kN]                             | 11,3                                 | 19,9                    | 32,7               | 49,3            | 78,7   | 108,4  | 180,0   |                  |                    |
|  | FAZ II Plus R            |   | 12,1                                 | 21,0                    | 34,5               | 52,0            | 83,0   | 127,6  | 187,0   |                  |                    |
|  | FAZ II Plus HCR          |   | 11,3                                 | 17,6                    | 29,1               | 43,8            | 69,9   |        |         |                  |                    |
| Partial factor for steel failure                             | FAZ II Plus              | $\gamma_{Ms}^{1)}$ [-]                      | 1,4                                  |                         |                    |                 |        | 1,4    | 1,5     |                  |                    |
|  | FAZ II Plus R            |   | 1,4                                  |                         |                    |                 |        | 1,45   |         |                  |                    |
|  | FAZ II Plus HCR          |   | 1,5                                  | 1,45                    |                    |                 | 1,4    | 1,5    |         |                  |                    |
| <b>Pullout failure</b>                                       |                          |   |                                      |                         |                    |                 |        |        |         |                  |                    |
| Effective embedment depth for calculation                    | $h_{ef}$ [mm]            |   | 40-80                                | 40 <sup>3)</sup> - < 45 | 45-90              | 40-100          | 50-125 | 65-160 | 100-180 | 125              |                    |
| Characteristic resistance in cracked concrete C20/25         | $N_{Rk,p}$ (C20/25) [kN] |   | 1,5                                  | 5,5                     | 8                  | 13              | 20     | 27,0   | 34,4    | 48,1             |                    |
| Characteristic resistance in uncracked concrete C20/25       |                          |   | 10,5                                 | 14                      |                    | 20              | 22     | 38,6   | 49,2    | 68,8             |                    |
| Increasing factor $\psi_c$ for cracked or uncracked concrete | [-]                      | $N_{Rk,p} = \psi_c \cdot N_{Rk,p}$ (C20/25) | C25/30                               |                         | 1,12               |                 |        |        |         |                  |                    |
|  |                          | C30/37                                      |                                      | 1,22                    |                    |                 |        |        |         |                  |                    |
|  |                          | C35/45                                      |                                      | 1,32                    |                    |                 |        |        |         |                  |                    |
|  |                          | C40/50                                      |                                      | 1,41                    |                    |                 |        |        |         |                  |                    |
|  |                          | C45/55                                      |                                      | 1,50                    |                    |                 |        |        |         |                  |                    |
| C50/60   |                          | 1,58  |                                      |                         |                    |                 |        |        |         |                  |                    |
| Installation sensitivity factor                              | $\gamma_{inst}$ [-]      |   | 1,0                                  |                         |                    |                 |        |        |         |                  |                    |
| <b>Concrete cone and splitting failure</b>                   |                          |   |                                      |                         |                    |                 |        |        |         |                  |                    |
| Factor for uncracked concrete                                | $k_{ucr,N}$ [-]          |   | 11,0 <sup>2)</sup>                   |                         |                    |                 |        |        |         |                  |                    |
| Factor for cracked concrete                                  | $k_{cr,N}$ [-]           |   | 7,7 <sup>2)</sup>                    |                         |                    |                 |        |        |         |                  |                    |
| Characteristic spacing                                       | $s_{cr,N}$ [mm]          |   | $3 \cdot h_{ef}$                     |                         |                    |                 |        |        |         |                  |                    |
| Characteristic edge distance                                 | $c_{cr,N}$ [mm]          |   | $1,5 \cdot h_{ef}$                   |                         |                    |                 |        |        |         |                  |                    |
| Characteristic spacing for splitting failure                 | $s_{cr,sp}$ [mm]         |   | $2 \cdot c_{cr,sp}$                  |                         |                    |                 |        |        |         |                  |                    |
| Characteristic edge distance for splitting failure h         | $c_{cr,sp}$ [mm]         | $\geq 80$                                   | 40                                   | $2,4 \cdot h_{ef}$      | $2 \cdot h_{ef}$   | - <sup>5)</sup> |        |        |         |                  |                    |
|  |                          | $\geq 100$                                  |                                      | $2 \cdot h_{ef}$        | $2,4 \cdot h_{ef}$ |                 |        |        |         | $2 \cdot h_{ef}$ |                    |
|  |                          | $\geq 120$                                  |                                      |                         | $2,1 \cdot h_{ef}$ |                 |        |        |         |                  |                    |
|  |                          | $\geq 140$                                  |                                      | $1,9 \cdot h_{ef}$      | $1,5 \cdot h_{ef}$ |                 |        |        |         | $2 \cdot h_{ef}$ | $2,4 \cdot h_{ef}$ |
|  |                          | $\geq 160$                                  |                                      |                         |                    |                 |        |        |         |                  |                    |
| $\geq 200$   |                          |   |                                      |                         | $2,2 \cdot h_{ef}$ |                 |        |        |         |                  |                    |
| Characteristic resistance to splitting                       | $N^0_{Rk,sp}$ [kN]       |   | $\min \{N^0_{Rk,c}; N_{Rk,p}\}^{4)}$ |                         |                    |                 |        |        |         |                  |                    |

<sup>1)</sup> In absence of other national regulations

<sup>2)</sup> Based on concrete strength as cylinder strength

<sup>3)</sup> For dry internal exposure and statically indeterminate redundant components, the minimum effective embedment depth can be reduced to 35 mm without reduction of  $N_{Rk,p}$ .

<sup>4)</sup>  $N^0_{Rk,c}$  according to EN 1992-4:2018

<sup>5)</sup> No performance assessed

fischer Bolt Anchor FAZ II Plus, FAZ II Plus R, FAZ II Plus HCR

**Performances**

Characteristic values of tension resistance under static and quasi-static action

**Annex C1**

Annex 11 / 19

**Table C2.1: Characteristic values of shear resistance under static and quasi-static action**

| Size  |  | FAZ II Plus, FAZ II Plus R, FAZ II Plus HCR |                            |              |              |                                  |                 |       |
|---|--|---|----------------------------|--------------|--------------|----------------------------------|-----------------|-------|
|   |  | M6  | M8                         | M10          | M12          | M16                              | M20             | M24   |
| <b>Steel failure without lever arm</b>  |  |   |                            |              |              |                                  |                 |       |
| Characteristic resistance   | FAZ II Plus without filling of the annular gap | 7,5   | 16,3                       | 26,2         | 37,0         | 68,4                             | 82,9            | 128,3 |
|   | FAZ II Plus with filling                       |   | 18,1                       | 27,3         | 40,7         | 69,8                             | 85,6            |       |
|   | FAZ II Plus without filling R                  | 8,8   | 17,6                       | 26,5         | 42,1         | 71,1                             | 107,9           | 158,1 |
|   | FAZ II Plus with filling R                     |   |                            | 27,6         | 44,3         | 73,6                             | 117,9           |       |
|   | FAZ II Plus without filling HCR                |   | 17,4                       | 23,7         | 42,1         | 71,1                             | 107,9           |       |
|   | FAZ II Plus with filling HCR                   |   |                            | 27,9         |              | 73,6                             | 117,9           |       |
| Partial factor for steel failure  | $\gamma_{Ms}^{1)}$                             | 1,25  |                            |              |              |                                  |                 |       |
| Factor for ductility  | $k_7$  | 1,0   |                            |              |              |                                  |                 |       |
| <b>Steel failure with lever arm and Concrete pryout failure</b>   |  |   |                            |              |              |                                  |                 |       |
| Effective embedment depth for calculation   | $h_{ef}$ [mm]                                  | 40-80                                       | 45-90                      | 60-100       | 70-125       | 85-160                           | 100-180         | 125   |
| Characteristic bending resistance   | FAZ II Plus                                    | 11  | 30                         | 60           | 105          | 266                              | 422             | 864   |
|   | FAZ II Plus R                                  |   | 29                         | 59           | 100          | 256                              | 519             | 898   |
|   | FAZ II Plus HCR                                |   |                            |              |              |                                  |                 |       |
| Factor for pryout failure   | $k_8$ [-]                                      | 2,6   | 2,8                        | 3,2          |              |                                  |                 |       |
| Effective embedment depth for calculation   | $h_{ef}$ [mm]                                  | - <sup>2)</sup>                             | 40 <sup>3)</sup><br>- < 45 | 40 -<br>< 60 | 50 -<br>< 70 | 65 -<br>< 85                     | - <sup>2)</sup> |       |
| Characteristic bending resistance   | FAZ II Plus                                    |   | 27                         | 56           | 105          | 251                              |                 |       |
|   | FAZ II Plus R                                  |   | 29                         | 59           | 100          | 256                              |                 |       |
|   | FAZ II Plus HCR                                |   | 24                         | 50           |              | 223                              |                 |       |
| Factor for pryout failure   | $k_8$ [-]                                      | 2,5   | 2,6                        | 3,1          | 3,2          |                                  |                 |       |
| Partial factor for steel failure  | $\gamma_{Ms}^{1)}$                             | 1,25  |                            |              |              |                                  |                 |       |
| Factor for ductility  | $k_7$  | 1,0   |                            |              |              |                                  |                 |       |
| <b>Concrete edge failure</b>  |  |   |                            |              |              |                                  |                 |       |
| Effective embedment depth for calculation   | $l_f$ [mm]                                     | $h_{ef}$                                    |                            |              |              |                                  |                 |       |
| Outside diameter of a fastener  | $d_{nom}$                                      | 6   | 8                          | 10           | 12           | 16                               | 20              | 24    |
| <p>1) In absence of other national regulations</p> <p>2) No performance assessed</p> <p>3) For dry internal exposure and statically indeterminate redundant components, the minimum effective embedment depth can be reduced to 35 mm without reduction of <math>N_{Rk,p}</math>.</p> |  |   |                            |              |              |                                  |                 |       |
| fischer Bolt Anchor FAZ II Plus, FAZ II Plus R,<br>FAZ II Plus HCR<br><br><b>Performances</b><br>Characteristic values of shear resistance under static and quasi-static action   |  |   |                            |              |              | <b>Annex C2</b><br>Annex 12 / 19 |                 |       |

**Table C3.1: Characteristic values of tension resistance under fire exposure**

| Size   |                        |                      | FAZ II Plus, FAZ II Plus R, FAZ II Plus HCR                                   |                                       |         |     |         |     |         |      |         |      |     |      |     |      |     |  |     |  |     |  |      |  |
|--|------------------------|----------------------|---|---------------------------------------|---------|-----|---------|-----|---------|------|---------|------|-----|------|-----|------|-----|--|-----|--|-----|--|------|--|
|  |                        |                      | M6  |                                       | M8      |     | M10     |     | M12     |      | M16     |      | M20 |      | M24 |      |     |  |     |  |     |  |      |  |
| h <sub>ef</sub> ≥ [mm]                             |                        |                      | 40  |                                       | 35   45 |     | 40   60 |     | 50   70 |      | 65   85 |      | 100 |      | 125 |      |     |  |     |  |     |  |      |  |
| Characteristic resistance<br>steel failure         | FAZ II Plus            | N <sub>Rk,s,fi</sub> | R30   | 0,6 <sup>1)</sup> / 0,9 <sup>2)</sup> |         | 1,4 |         | 2,8 |         | 5,0  |         | 9,4  |     | 14,7 |     | 21,1 |     |  |     |  |     |  |      |  |
|  |                        |                      | R60   | 0,4 <sup>1)</sup> / 0,9 <sup>2)</sup> |         | 1,2 |         | 2,3 |         | 4,1  |         | 7,7  |     | 12,0 |     | 17,3 |     |  |     |  |     |  |      |  |
|  |                        |                      | R90   | 0,3 <sup>1)</sup> / 0,9 <sup>2)</sup> |         | 0,9 |         | 1,9 |         | 3,2  |         | 6,0  |     | 9,4  |     | 13,5 |     |  |     |  |     |  |      |  |
|  |                        |                      | R120  | 0,2 <sup>1)</sup> / 0,7 <sup>2)</sup> |         | 0,8 |         | 1,6 |         | 2,8  |         | 5,2  |     | 8,1  |     | 11,6 |     |  |     |  |     |  |      |  |
|  | FAZ II Plus<br>R / HCR | N <sub>Rk,s,fi</sub> | R30   | 0,6 <sup>1)</sup> / 0,9 <sup>2)</sup> |         | 3,6 |         | 7,8 |         | 11,5 |         | 21,8 |     | 34,3 |     | 49,4 |     |  |     |  |     |  |      |  |
|  |                        |                      | R60   | 0,4 <sup>1)</sup> / 0,9 <sup>2)</sup> |         | 2,3 |         | 4,8 |         | 7,1  |         | 13,2 |     | 20,7 |     | 29,3 |     |  |     |  |     |  |      |  |
|  |                        |                      | R90   | 0,3 <sup>1)</sup> / 0,9 <sup>2)</sup> |         | 1,9 |         | 3,8 |         | 5,7  |         | 10,5 |     | 18,3 |     | 26,4 |     |  |     |  |     |  |      |  |
|  |                        |                      | R120 [kN]   | 0,2 <sup>1)</sup> / 0,7 <sup>2)</sup> |         | 1,6 |         | 3,3 |         | 4,9  |         | 8,6  |     | 17,3 |     | 25,0 |     |  |     |  |     |  |      |  |
| Characteristic resistance<br>Concrete cone failure | N <sub>Rk,c,fi</sub>   | R30<br>- R90         | $7,7 \cdot h_{ef}^{1,5} \cdot (20)^{0,5} \cdot h_{ef} / 200 / 1000$           |                                       |         |     |         |     |         |      |         |      |     |      |     |      |     |  |     |  |     |  |      |  |
|  |                        | R120                 | $7,7 \cdot h_{ef}^{1,5} \cdot (20)^{0,5} \cdot h_{ef} / 200 / 1000 \cdot 0,8$ |                                       |         |     |         |     |         |      |         |      |     |      |     |      |     |  |     |  |     |  |      |  |
|  |                        | R30                  |   |                                       |         |     |         |     |         |      |         |      |     |      |     |      |     |  |     |  |     |  |      |  |
| Characteristic resistance<br>pullout failure       | N <sub>Rk,p,fi</sub>   | R60                  | 0,4   |                                       | 0,9     |     | 2,0     |     | 2,2     |      | 3,3     |      | 3,0 |      | 5,0 |      | 4,5 |  | 6,8 |  | 8,6 |  | 12,0 |  |
|  |                        | R90                  |   |                                       | 0,8     |     |         |     |         |      |         |      |     |      |     |      |     |  |     |  |     |  |      |  |
|  |                        | R120                 | 0,3   |                                       | 0,5     |     | 1,6     |     | 1,7     |      | 2,6     |      | 2,4 |      | 4,0 |      | 3,6 |  | 5,4 |  | 6,9 |  | 9,6  |  |
|  |                        | R30                  |   |                                       |         |     |         |     |         |      |         |      |     |      |     |      |     |  |     |  |     |  |      |  |

**Table C3.2: Characteristic values of shear resistance under fire exposure**

| FAZ II Plus |     |                        | R30                                   |  | R60                                   |   |                                       |  |                                       |  |
|-------------|-----|------------------------|---------------------------------------|--|---------------------------------------|---|---------------------------------------|--|---------------------------------------|--|
|             |     |                        | V <sub>Rk,s,fi,30</sub><br>[kN]       | M <sup>0</sup> <sub>Rk,s,fi,30</sub><br>[Nm] | V <sub>Rk,s,fi,60</sub><br>[kN]       | M <sup>0</sup> <sub>Rk,s,fi,60</sub><br>[Nm]  |                                       |  |                                       |  |
| M6          | 40  | h <sub>ef</sub> ≥ [mm] | 0,6 <sup>1)</sup> / 0,9 <sup>2)</sup> |  | 0,5 <sup>1)</sup> / 0,2 <sup>2)</sup> |   | 0,4 <sup>1)</sup> / 0,9 <sup>2)</sup> |  | 0,3 <sup>1)</sup> / 0,1 <sup>2)</sup> |  |
| M8          | 35  |                        | 1,8                                   |  | 1,4                                   |   | 1,6                                   |  | 1,2                                   |  |
| M10         | 40  |                        | 3,6                                   |  | 3,6                                   |   | 2,9                                   |  | 3,0                                   |  |
| M12         | 50  |                        | 6,3                                   |  | 7,8                                   |   | 4,9                                   |  | 6,4                                   |  |
| M16         | 65  |                        | 11,7                                  |  | 19,9                                  |   | 9,1                                   |  | 16,3                                  |  |
| M20         | 100 |                        | 18,2                                  |  | 39,0                                  |   | 14,2                                  |  | 31,8                                  |  |
| M24         | 125 |                        | 26,3                                  |  | 67,3                                  |   | 20,5                                  |  | 55,0                                  |  |
| FAZ II Plus |     |                        | R90                                   |  | R120                                  |   |                                       |  |                                       |  |
|             |     |                        | V <sub>Rk,s,fi,90</sub><br>[kN]       | M <sup>0</sup> <sub>Rk,s,fi,90</sub><br>[Nm] | V <sub>Rk,s,fi,120</sub><br>[kN]      | M <sup>0</sup> <sub>Rk,s,fi,120</sub><br>[Nm] |                                       |  |                                       |  |
| M6          | 40  | h <sub>ef</sub> ≥ [mm] | 0,3 <sup>1)</sup> / 0,9 <sup>2)</sup> |  | 0,2 <sup>1)</sup> / 0,1 <sup>2)</sup> |   | 0,2 <sup>1)</sup> / 0,7 <sup>2)</sup> |  | 0,2 <sup>1)</sup> / 0,1 <sup>2)</sup> |  |
| M8          | 35  |                        | 1,3                                   |  | 1,0                                   |   | 1,2                                   |  | 0,8                                   |  |
| M10         | 40  |                        | 2,2                                   |  | 2,4                                   |   | 1,9                                   |  | 2,1                                   |  |
| M12         | 50  |                        | 3,5                                   |  | 5,0                                   |   | 2,8                                   |  | 4,3                                   |  |
| M16         | 65  |                        | 6,6                                   |  | 12,6                                  |   | 5,3                                   |  | 11,0                                  |  |
| M20         | 100 |                        | 10,3                                  |  | 24,6                                  |   | 8,3                                   |  | 21,4                                  |  |
| M24         | 125 |                        | 14,8                                  |  | 42,6                                  |   | 11,9                                  |  | 37,0                                  |  |

Concrete pryout failure according to EN 1992-4:2018

<sup>1)</sup> FAZ II Plus

<sup>2)</sup> FAZ II Plus R / FAZ II Plus HCR

fischer Bolt Anchor FAZ II Plus, FAZ II Plus R,  
FAZ II Plus HCR

**Performances**

Characteristic values of resistance under fire exposure

**Annex C3**

Annex 13 / 19

**Table C4.1: Characteristic values of shear resistance under fire exposure**

| FAZ II Plus R, FAZ II Plus HCR |               |     | R30                                   |                                       | R60                                   |                                       |
|--------------------------------|---------------|-----|---------------------------------------|---------------------------------------|---------------------------------------|---------------------------------------|
|                                |               |     | $V_{Rk,s,fi,30}$ [kN]                 | $M^0_{Rk,s,fi,30}$ [Nm]               | $V_{Rk,s,fi,60}$ [kN]                 | $M^0_{Rk,s,fi,60}$ [Nm]               |
| M6                             | $h_{ef} \geq$ | 40  | 0,6 <sup>1)</sup> / 0,9 <sup>2)</sup> | 0,5 <sup>1)</sup> / 0,2 <sup>2)</sup> | 0,4 <sup>1)</sup> / 0,9 <sup>2)</sup> | 0,3 <sup>1)</sup> / 0,1 <sup>2)</sup> |
| M8                             |               | 35  | 3,6                                   | 3,7                                   | 2,3                                   | 2,4                                   |
| M10                            |               | 40  | 7,8                                   | 10,1                                  | 4,8                                   | 6,2                                   |
| M12                            |               | 50  | 11,5                                  | 17,9                                  | 7,1                                   | 11,1                                  |
| M16                            |               | 65  | 21,8                                  | 46,2                                  | 13,2                                  | 27,9                                  |
| M20                            |               | 100 | 34,3                                  | 90,9                                  | 20,7                                  | 54,9                                  |
| M24                            |               | 125 | 49,4                                  | 157,2                                 | 29,3                                  | 93,1                                  |
| FAZ II Plus R, FAZ II Plus HCR |               |     | R90                                   |                                       | R120                                  |                                       |
|                                |               |     | $V_{Rk,s,fi,90}$ [kN]                 | $M^0_{Rk,s,fi,90}$ [Nm]               | $V_{Rk,s,fi,120}$ [kN]                | $M^0_{Rk,s,fi,120}$ [Nm]              |
| M6                             | $h_{ef} \geq$ | 40  | 0,3 <sup>1)</sup> / 0,9 <sup>2)</sup> | 0,2 <sup>1)</sup> / 0,1 <sup>2)</sup> | 0,2 <sup>1)</sup> / 0,7 <sup>2)</sup> | 0,2 <sup>1)</sup> / 0,1 <sup>2)</sup> |
| M8                             |               | 35  | 1,9                                   | 1,9                                   | 1,6                                   | 1,7                                   |
| M10                            |               | 40  | 3,8                                   | 4,9                                   | 3,3                                   | 4,3                                   |
| M12                            |               | 50  | 5,7                                   | 8,8                                   | 4,9                                   | 7,6                                   |
| M16                            |               | 65  | 10,5                                  | 22,1                                  | 8,6                                   | 18,3                                  |
| M20                            |               | 100 | 18,3                                  | 48,6                                  | 17,3                                  | 45,9                                  |
| M24                            |               | 125 | 26,4                                  | 84,0                                  | 25,0                                  | 79,4                                  |

<sup>1)</sup> FAZ II Plus

<sup>2)</sup> FAZ II Plus R / FAZ II Plus HCR

Concrete pryout failure according to EN 1992-4:2018

**Table C4.2: Minimum spacings and minimum edge distances of fasteners under fire exposure for tension and shear load**

| Size                         | FAZ II Plus, FAZ II Plus R, FAZ II Plus HCR   |    |     |     |     |     |     |
|------------------------------|---|----|-----|-----|-----|-----|-----|
|                              | M6  | M8 | M10 | M12 | M16 | M20 | M24 |
| Spacing $s_{min}$            | Annex C5  |    |     |     |     |     |     |
| Edge distance $c_{min}$ [mm] | $c_{min} = 2 \cdot h_{ef}$ ,<br>for fire exposure from more than one side $c_{min} \geq 300$ mm |    |     |     |     |     |     |

fischer Bolt Anchor FAZ II Plus, FAZ II Plus R,  
FAZ II Plus HCR

**Performances**

Characteristic values of resistance under fire exposure

**Annex C4**

Annex 14 / 19



**Table C5.1:** Minimum thickness of concrete members, minimum spacing and minimum edge distance

| Size                                 | FAZ II Plus, FAZ II Plus R, FAZ II Plus HCR   |     |     |     |   |     |     |       |
|--------------------------------------|---|-----|-----|-----|---|-----|-----|-------|
|                                      | M6  | M8  | M10 | M12 | M16   | M20 | M24 |       |
| <b>Minimum edge distance</b>         |   |     |     |     |   |     |     |       |
| Uncracked concrete                   | 40  | 40  | 45  | 55  | 65  | 95  | 135 |       |
| Cracked concrete                     |   |     |     |     |   | 85  | 100 |       |
| Corresponding                        | s [mm] according to Annex C6  |     |     |     |   |     |     |       |
| Minimum thickness of concrete member | 80  |     | 100 | 140 | 160   | 200 |     |       |
| Thickness of concrete member         | h ≥ max. {h <sub>min</sub> ; 1,5 · h <sub>ef</sub> ; h <sub>1</sub> <sup>1)</sup> + 25} |     |     |     | max. {h <sub>min</sub> ; 1,5 · h <sub>ef</sub> ; h <sub>1</sub> <sup>1)</sup> + 30} |     |     |       |
| <b>Minimum spacing</b>               |   |     |     |     |   |     |     |       |
| Uncracked concrete                   | 35  | 40  | 40  | 50  | 65  | 95  | 100 |       |
| Cracked concrete                     |   | 35  |     |     |   |     |     |       |
| Corresponding                        | c [mm] according to Annex C6  |     |     |     |   |     |     |       |
| Minimum thickness of concrete member | 80  |     | 100 | 140 | 160   | 200 |     |       |
| Thickness of concrete member         | h ≥ max. {h <sub>min</sub> ; 1,5 · h <sub>ef</sub> ; h <sub>1</sub> + 25}               |     |     |     | max. {h <sub>min</sub> ; 1,5 · h <sub>ef</sub> ; h <sub>1</sub> + 30}               |     |     |       |
| <b>Minimum splitting area</b>        |   |     |     |     |   |     |     |       |
| Uncracked concrete                   | A <sub>sp,req</sub> [·1000 mm <sup>2</sup> ]  | 5,1 | 18  | 37  | 54  | 67  | 100 | 117,5 |
| Cracked concrete                     |   | 1,5 | 12  | 27  | 40  | 50  | 77  | 87,5  |

<sup>1)</sup> If borehole cleaning is omitted, h<sub>1</sub> is replaced by h<sub>1,nc</sub>

**Table C5.2:** Minimum spacing and minimum edge distances - calculated values for **cracked concrete with one edge** (c<sub>2</sub> and c<sub>3</sub> ≥ 1,5 c<sub>1</sub>)

| Type of anchor / size                | FAZ II Plus, FAZ II Plus R, FAZ II Plus HCR |    |     |     |     |     |     |     |     |     |     |     |
|--------------------------------------|---|----|-----|-----|-----|-----|-----|-----|-----|-----|-----|-----|
|                                      | M6  | M8 | M10 | M12 | M16 | M20 | M24 |     |     |     |     |     |
| Effective anchorage depth            | h <sub>ef</sub> ≥ [mm]                      | 40 | 35  | 45  | 40  | 60  | 50  | 70  | 65  | 85  | 100 | 125 |
| Minimum thickness of concrete member | h <sup>1)</sup> ≥ [mm]                      | 80 |     | 85  | 80  | 120 | 100 | 140 | 140 | 180 | 160 | 200 |
| Minimum spacing                      | S <sub>min</sub> [mm]                       | 35 |     | 40  | 50  | 65  | 95  | 100 |     |     |     |     |
|                                      | for c ≥ [mm]                                | 40 | 100 | 65  | 120 | 80  | 100 | 75  | 130 | 115 |     |     |
| Minimum edge distance                | c <sub>min</sub> [mm]                       | 40 | 60  | 45  | 70  | 55  | 65  | 85  | 100 |     |     |     |
|                                      | for s ≥ [mm]                                | 35 | 160 | 90  | 190 | 125 | 165 | 85  | 230 | 140 |     |     |

<sup>1)</sup> thickness of concrete member has to be increased by 15 mm, if borehole cleaning is omitted

fischer Bolt Anchor FAZ II Plus, FAZ II Plus R, FAZ II Plus HCR

**Performances**

Minimum thickness of member, minimum spacing and edge distances

**Annex C5**

Annex 15 / 19

## Determination of $A_{sp,ef}$ for each existing free edge

**Splitting failure** applied for minimum edge distance and spacing in depending on  $h_{ef}$

Definition Index:

cal = calculatory

e.g.:  $s_{x,y}$

x = load direction

y = number anchor plate

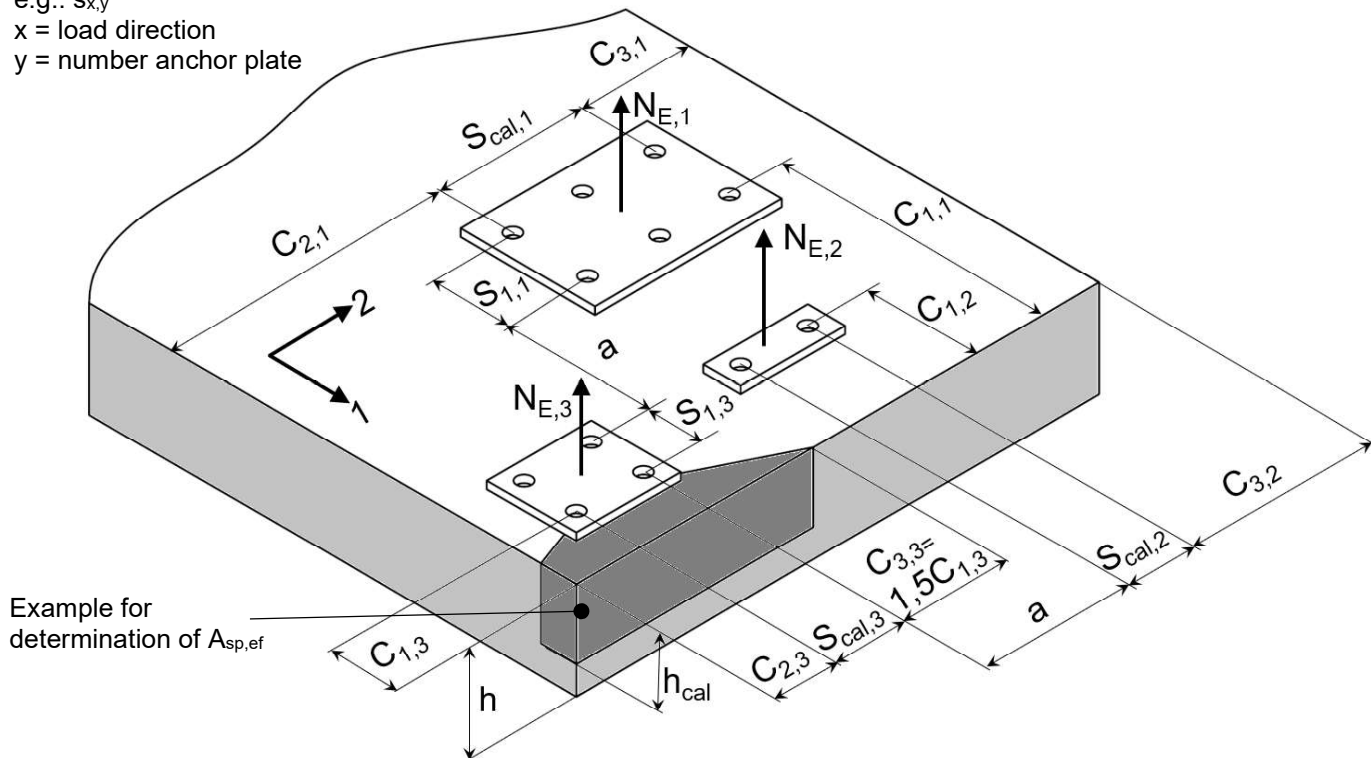

Example for determination of  $A_{sp,ef}$

Example for different anchor plates: For considering all free edges the direction 1 and 2 must be swapped.

General formulation for each free edge:  $A_{sp,ef} = (C_2 + s_{cal} + C_3) \cdot h_{cal} \geq (n/2) \cdot A_{sp,req}$

with:

Edge distance  $C_1$ :  $C_{min} \leq C_1$

Edge distance  $C_2$ :  $C_{min} \leq C_2 \leq 1,5 \cdot C_1$

Edge distance  $C_3$ :  $C_{min} \leq C_3 \leq 1,5 \cdot C_1$

Calculation spacing, distance between outer anchors  $s_{cal}$ :  $s_{min} \leq s_{cal} \leq 3,0 \cdot C_1$

Distance between group of anchors  $a$ : For  $a \geq 3,0 \cdot C_1$  no influence between the anchor groups is taken into account.

Number of anchors  $n$  of an anchor plate as well close and parallel to the edge

Effective member thickness  $h_{cal}$ :  $h_{min} \leq h$ ;  $h_{cal} \leq h$ ;  $h_{cal} \leq (h_{ef} + 1,5 \cdot C_1)$

$C_1$ ,  $C_2$ ,  $C_3$ ,  $h$  and  $s_{cal}$  have to be set in way that the requirement is fulfilled

For the calculation of minimum spacing and minimum edge distance of fasteners in combination with different embedment depths and thicknesses of concrete members the following equation shall be fulfilled:

$$A_{sp,req} < A_{sp,ef}$$

$A_{sp,req}$  = required splitting area (according to Annex C 5)

$A_{sp,ef}$  = effective splitting area

(Figure not to scale)

fischer Bolt Anchor FAZ II Plus, FAZ II Plus R,  
FAZ II Plus HCR

### Performances

Minimum thickness of member, minimum spacings and edge distances

### Annex C6

Annex 16 / 19

**Table C7.1: Characteristic values of tension and shear resistance under seismic action category C1**

| Size   | FAZ II Plus, FAZ II Plus R, FAZ II Plus HCR |                                    |        |        |        |        |         |         |       |
|--|---|------------------------------------|--------|--------|--------|--------|---------|---------|-------|
|  | M6  | M8                                 |        | M10    | M12    | M16    | M20     | M24     |       |
| Effective embedment depth $h_{ef}$ [mm]  | - 2)  | 40 - <45                           | 45-90  | 40-100 | 50-125 | 85-160 | 100-180 | 125     |       |
| With filling of the annular gap  |   | 1,0                                |        |        |        |        |         |         |       |
| Without filling of the annular gap $\alpha_{gap}$ [-]  |   | 0,5                                |        |        |        |        |         |         |       |
| <b>Steel failure <math>N_{RK,s,C1} = N_{RK,s}</math>; <math>\gamma_{Ms,C1} = \gamma_{Ms}</math> (see Annex C1)</b>                           |   |                                    |        |        |        |        |         |         |       |
| <b>Pullout failure</b>   |   |                                    |        |        |        |        |         |         |       |
| Characteristic resistance in cracked concrete C1 $N_{RK,p,C1}$ [kN]  | - 2)  | 5,1                                | 7,4    | 11,6   | 20,0   | 27,0   | 34,4    | 48,1    |       |
| Installation sensitivity factor $\gamma_{Inst}$ [-]  |   | 1,0                                |        |        |        |        |         |         |       |
| <b>Concrete cone failure and splitting failure <math>N_{RK,c,C1} = N_{RK,c}</math>; <math>N_{RK,sp,C1} = N_{RK,sp}</math> (see Annex C1)</b> |   |                                    |        |        |        |        |         |         |       |
| <b>Steel failure without lever arm</b>   |   |                                    |        |        |        |        |         |         |       |
| <b>FAZ II Plus</b>   |   |                                    |        |        |        |        |         |         |       |
| Characteristic resistance C1   | $h_{ef}$ [mm]                               | Without filling $V_{RK,s,C1}$ [kN] | - 2)   | 45-90  | 60-100 | 70-125 | 85-160  | 100-180 | 125   |
|  |   |                                    |        | 14,8   | 23,6   | 33,3   | 58,1    | 71,2    | 102,6 |
|  | With filling $V_{RK,s,C1}$ [kN]             | 16,5                               | 24,6   | 39,9   | 59,3   | 85,6   |         |         |       |
|  | $h_{ef}$ [mm]                               | Without filling $V_{RK,s,C1}$ [kN] | - 2)   | 40-<45 | 40-<60 | 50-<70 | - 2)    |         |       |
|  | Without filling $V_{RK,s,C1}$ [kN]          |                                    |        | - 2)   |        | 32,9   |         |         |       |
|  | With filling $V_{RK,s,C1}$ [kN]             | 15,6                               | 19,7   | 39,9   |        |        |         |         |       |
|  | <b>FAZ II Plus R</b>                        |                                    |        |        |        |        |         |         |       |
|  | $h_{ef}$ [mm]                               | Without filling $V_{RK,s,C1}$ [kN] | - 2)   | 45-90  | 60-100 | 70-125 | 85-160  | 100-180 | 125   |
|  |   |                                    |        | 16,0   | 23,9   | 37,9   | 60,4    | 86,3    | 126,5 |
|  | With filling $V_{RK,s,C1}$ [kN]             | 24,8                               | 43,4   | 62,6   | 94,3   |        |         |         |       |
|  | $h_{ef}$ [mm]                               | Without filling $V_{RK,s,C1}$ [kN] | - 2)   | 40-<45 | 40-<60 | 50-<70 | - 2)    |         |       |
|  | Without filling $V_{RK,s,C1}$ [kN]          |                                    |        | - 2)   |        | 37,5   |         |         |       |
| With filling $V_{RK,s,C1}$ [kN]  | 15,1  | 19,9                               | 43,4   |        |        |        |         |         |       |
| <b>FAZ II Plus HCR</b>   |   |                                    |        |        |        |        |         |         |       |
| $h_{ef}$ [mm]  | Without filling $V_{RK,s,C1}$ [kN]          | - 2)                               | 45-90  | 60-100 | 70-125 | 85-160 | 100-180 | 125     |       |
|  |   |                                    | 15,8   | 21,3   | 37,9   | 60,4   | 86,3    | 126,5   |       |
| With filling $V_{RK,s,C1}$ [kN]  | 25,1  | 41,3                               | 62,6   | 94,3   |        |        |         |         |       |
| $h_{ef}$ [mm]  | Without filling $V_{RK,s,C1}$ [kN]          | - 2)                               | 40-<45 | 40-<60 | 50-<70 | - 2)   |         |         |       |
| Without filling $V_{RK,s,C1}$ [kN]   |   |                                    | - 2)   |        | 37,5   |        |         |         |       |
| With filling $V_{RK,s,C1}$ [kN]  | 15,0  | 20,1                               | 41,3   |        |        |        |         |         |       |
| Partial factor for steel failure $\gamma_{Ms,C1}^{1)}$ [-]   | 1,25  |                                    |        |        |        |        |         |         |       |

1) In absence of other national regulations

2) No performance assessed

fischer Bolt Anchor FAZ II Plus, FAZ II Plus R, FAZ II Plus HCR

**Performances**

Characteristic values of tension and shear resistance under seismic action category C1

**Annex C7**

Annex 17 / 19

**Table C8.1: Characteristic values of tension and shear resistance under seismic action category C2**

| Size   |                                    | FAZ II Plus, FAZ II Plus R, FAZ II Plus HCR |          |          |          |         |         |       |  |
|--|------------------------------------|---|----------|----------|----------|---------|---------|-------|--|
|  |                                    | M6  | M8       | M10      | M12      | M16     | M20     | M24   |  |
| With filling of the annular gap  | $\alpha_{gap}$ [-]                 | -2)   |          | 1,0      |          |         |         |       |  |
| Without filling of the annular gap   |                                    |   |          | 0,5      |          |         |         |       |  |
| <b>Steel failure <math>N_{Rk,s,C2} = N_{Rk,s}</math>; <math>\gamma_{Ms,C2} = \gamma_{Ms}</math> (see Annex C1)</b>                           |                                    |   |          |          |          |         |         |       |  |
| <b>Pullout failure</b>   |                                    |   |          |          |          |         |         |       |  |
| Characteristic resistance in cracked concrete C2   | $h_{ef}$ [mm]                      | -2)   | 60-100   | 70-125   | 85-160   | 100-180 | 125     |       |  |
|  | $N_{Rk,p,C2}$ [kN]                 |   | 5,1      | 7,4      | 21,5     | 30,7    | 39,6    |       |  |
|  | $h_{ef}$ [mm]                      |   | 40 - <60 | 50 - <70 | 65 - <85 | -2)     |         |       |  |
|  | $N_{Rk,p,C2}$ [kN]                 |   | 2,7      | 4,4      | 16,4     |         |         |       |  |
| Installation sensitivity factor  | $\gamma_{inst}$ [-]                | 1,0   |          |          |          |         |         |       |  |
| <b>Concrete cone failure and splitting failure <math>N_{Rk,c,C2} = N_{Rk,c}</math>; <math>N_{Rk,sp,C2} = N_{Rk,sp}</math> (see Annex C1)</b> |                                    |   |          |          |          |         |         |       |  |
| <b>Steel failure without lever arm</b>   |                                    |   |          |          |          |         |         |       |  |
| <b>FAZ II Plus</b>   |                                    |   |          |          |          |         |         |       |  |
| Characteristic resistance C2   | $h_{ef}$ [mm]                      | -2)   | 60-100   | 70-125   | 85-160   | 100-180 | 125     |       |  |
|  | Without filling $V_{Rk,s,C2}$ [kN] |   | 17,6     | 27,8     | 37,6     | 62,2    | 70,6    |       |  |
|  | With filling $V_{Rk,s,C2}$ [kN]    |   | 20,5     | 30,5     | 52,4     | 68,5    | 102,6   |       |  |
|  | $h_{ef}$ [mm]                      |   | 40 - <60 | 50 - <70 | 65 - <85 | -2)     |         |       |  |
|  | Without filling $V_{Rk,s,C2}$ [kN] |   | 14,1     | 24,4     | 31,2     |         |         |       |  |
|  | With filling $V_{Rk,s,C2}$ [kN]    |   | 14,7     | 30,5     | 52,4     |         |         |       |  |
|  | <b>FAZ II Plus R</b>               |   |          |          |          |         |         |       |  |
|  | $h_{ef}$ [mm]                      |   | -2)      | 60-100   | 70-125   | 85-160  | 100-180 | 125   |  |
|  | Without filling $V_{Rk,s,C2}$ [kN] |   |          | 17,8     | 31,6     | 39,1    | 70,5    | 87,0  |  |
|  | With filling $V_{Rk,s,C2}$ [kN]    |   |          | 20,7     | 33,2     | 55,2    | 104,9   | 126,5 |  |
| $h_{ef}$ [mm]  | 40 - <60                           | 50 - <70                                    |          | 65 - <85 | -2)      |         |         |       |  |
| Without filling $V_{Rk,s,C2}$ [kN]   | 14,3                               | 27,8  |          | 32,4     |          |         |         |       |  |
| With filling $V_{Rk,s,C2}$ [kN]  | 14,9                               | 33,2  |          | 55,2     |          |         |         |       |  |
| <b>FAZ II Plus HCR</b>   |                                    |   |          |          |          |         |         |       |  |
| $h_{ef}$ [mm]  | -2)                                | 60-100                                      |          | 70-125   | 85-160   | 100-180 | 125     |       |  |
| Without filling $V_{Rk,s,C2}$ [kN]   |                                    | 15,9  |          | 31,6     | 39,1     | 70,5    | 87,0    |       |  |
| With filling $V_{Rk,s,C2}$ [kN]  |                                    | 20,9  |          |          | 55,2     | 104,9   | 126,5   |       |  |
| $h_{ef}$ [mm]  |                                    | 40 - <60                                    | 50 - <70 | 65 - <85 | -2)      |         |         |       |  |
| Without filling $V_{Rk,s,C2}$ [kN]   |                                    | 12,8  | 27,8     | 32,4     |          |         |         |       |  |
| With filling $V_{Rk,s,C2}$ [kN]  |                                    | 15,1  | 31,6     | 55,2     |          |         |         |       |  |
| Partial factor for steel   |                                    | $\gamma_{Ms,C2}^{1)}$ [-]                   | 1,25     |          |          |         |         |       |  |

1) In absence of other national regulations

2) No performance assessed

fischer Bolt Anchor FAZ II Plus, FAZ II Plus R, FAZ II Plus HCR

**Performances**

Characteristic values of resistance under tension and shear loads under seismic action category C2

**Annex C8**

Annex 18 / 19

**Table C9.1: Displacements** under static and quasi static **tension** loads

| Size   | FAZ II Plus, FAZ II Plus R, FAZ II Plus HCR |      |      |      |      |      |      |
|--|---|------|------|------|------|------|------|
|  | M6  | M8   | M10  | M12  | M16  | M20  | M24  |
| <b>Displacement – factor for tensile load<sup>1)</sup></b> |   |      |      |      |      |      |      |
| $\delta_{N0}$ - factor                                     | 0,13  | 0,22 | 0,12 | 0,09 | 0,08 | 0,07 | 0,05 |
| $\delta_{N\infty}$ - factor                                | 1,00  | 0,78 | 0,40 | 0,19 | 0,09 |      | 0,07 |
| $\delta_{N0}$ - factor                                     | 0,16  | 0,07 | 0,05 | 0,06 |      | 0,05 | 0,04 |
| $\delta_{N\infty}$ - factor                                | 0,24  | 0,29 | 0,21 | 0,14 | 0,10 | 0,06 | 0,05 |

**Table C9.2: Displacements** under static and quasi static **shear** loads

| Size   | FAZ II Plus, FAZ II Plus R, FAZ II Plus HCR |      |      |      |      |      |      |
|--|---|------|------|------|------|------|------|
|  | M6  | M8   | M10  | M12  | M16  | M20  | M24  |
| <b>Displacement – factor for shear load<sup>2)</sup></b> |   |      |      |      |      |      |      |
| <b>FAZ II Plus</b>                                       |   |      |      |      |      |      |      |
| $\delta_{V0}$ - factor                                   | 0,6   | 0,35 | 0,37 | 0,27 | 0,10 | 0,09 | 0,07 |
| $\delta_{V\infty}$ - factor                              | 0,9   | 0,52 | 0,55 | 0,40 | 0,14 | 0,15 | 0,11 |
| <b>FAZ II Plus R, FAZ II Plus HCR</b>                    |   |      |      |      |      |      |      |
| $\delta_{V0}$ - factor                                   | 0,6   | 0,23 | 0,19 | 0,18 | 0,10 | 0,11 | 0,07 |
| $\delta_{V\infty}$ - factor                              | 0,9   | 0,35 | 0,29 | 0,27 | 0,15 | 0,17 | 0,11 |

<sup>1)</sup> Calculation of effective displacement:

$$\delta_{N0} = \delta_{N0} - \text{factor} \cdot N$$

$$\delta_{N\infty} = \delta_{N\infty} - \text{factor} \cdot N$$

N = Action tension loading

<sup>2)</sup> Calculation of effective displacement:

$$\delta_{V0} = \delta_{V0} - \text{factor} \cdot V$$

$$\delta_{V\infty} = \delta_{V\infty} - \text{factor} \cdot V$$

V = Action shear loading

**Table C9.3: Displacements** under **tension** loads for **category C2** for all embedment depths

| Size                     | FAZ II Plus, FAZ II Plus R, FAZ II Plus HCR |    |      |      |      |      |      |
|--------------------------|---|----|------|------|------|------|------|
|                          | M6  | M8 | M10  | M12  | M16  | M20  | M24  |
| DLS $\delta_{N,C2(DLS)}$ | - <sup>1)</sup>                             |    | 2,7  | 4,4  |      | 5,6  | 4,8  |
| ULS $\delta_{N,C2(ULS)}$ | - <sup>1)</sup>                             |    | 11,5 | 13,0 | 12,3 | 14,4 | 15,2 |

<sup>1)</sup> No performance assessed

**Table C9.4: Displacements** under **shear** loads for **category C2** for all embedment depths

| Size                                     | FAZ II Plus, FAZ II Plus R, FAZ II Plus HCR |    |     |     |     |     |     |
|--|---|----|-----|-----|-----|-----|-----|
|  | M6  | M8 | M10 | M12 | M16 | M20 | M24 |
| DLS without filling $\delta_{V,C2(DLS)}$ | - <sup>1)</sup>                             |    | 5,0 |     |     | 4,8 | 4,2 |
| ULS without filling $\delta_{V,C2(ULS)}$ | - <sup>1)</sup>                             |    | 7,8 | 6,3 | 8,8 | 6,3 | 7,4 |
| DLS with filling $\delta_{V,C2(DLS)}$    | - <sup>1)</sup>                             |    | 1,2 |     |     | 2,0 | 4,2 |
| ULS with filling $\delta_{V,C2(ULS)}$    | - <sup>1)</sup>                             |    | 4,2 | 5,8 | 3,1 | 4,4 | 7,4 |

<sup>1)</sup> No performance assessed

fischer Bolt Anchor FAZ II Plus, FAZ II Plus R,  
FAZ II Plus HCR

**Performances**

Displacements under tension and shear loads

**Annex C9**

Annex 19 / 19