

## DEKLARACJA WŁAŚCIWOŚCI UŻYTKOWYCH

### DoP-FS-1002

dla fischer FiAM Intumescent Acoustic Mastic (Produkty ogniochronne i uszczelniające: uszczelnianie złączy liniowych i szczelin)

PL

1. Niepowtarzalny kod identyfikacyjny typu wyrobu: DoP-FS-1002
2. Zamierzone zastosowanie: Utrzymanie integralności efektu izolacyjnego jednej lub więcej przegród ogniowych przy nieciągłościach liniowych przez określony czas, zobacz załącznik, w szczególności aneksy 1-2.
3. Producent: fischerwerke GmbH & Co. KG, Klaus-Fischer-Str. 1, 72178 Waldachtal, Niemcy
4. Upoważniony przedstawiciel: -
5. System(-y) oceny i weryfikacji stałości właściwości użytkowych: 1
6. Europejski dokument oceny: EAD 350141-00-1106  
Europejska ocena techniczna: ETA-20/1065; 2021-05-10  
Jednostka ds. oceny technicznej: ETA-Danmark A/S  
Jednostka lub jednostki notyfikowane: 2531 – DBI Certification A/S
7. Deklarowane właściwości użytkowe:
  - Ochrona przeciwpożarowa (BWR 2)**  
Reakcja na ogień: NPD  
Odporność na działanie ognia: Aneksy 5-29
  - Higiena, zdrowie i środowisko (BWR 3)**  
Treść, emisja i / lub uwalnianie substancji niebezpiecznych: Aneks 3  
Przepuszczalność powietrza (właściwość materiału): Aneks 30  
Przepuszczalność wody (właściwość materiału): NPD
  - Bezpieczeństwo użytkowania (BWR 4)**  
Wytrzymałość mechaniczna i stabilność: NPD  
Wytrzymałość na wstrząsy/ruch: NPD  
Przyczepność: Aneks 1  
Trwałość: Aneks 3  
Zdolność ruchu: Aneksy 5-29  
Cykliczny ruch uszczelnień obwodowych ścian osłonowych: NPD  
Zestaw do kompresji: NPD  
Rozszerzenie liniowe podczas ustawiania: NPD
  - Ochrona przed hałasem (BWR 5)**  
Izolacja od dźwięków powietrznych: Aneksy 31-32
  - Oszczędność energii i zatrzymywanie ciepła (BWR 6)**  
Właściwości termiczne: NPD  
Przepuszczalność pary wodnej: NPD
8. Odpowiednia dokumentacja techniczna lub specjalna dokumentacja techniczna: -

Właściwości użytkowe określonego powyżej wyrobu są zgodne z zestawem deklarowanych właściwości użytkowych. Niniejsza deklaracja właściwości użytkowych wydana zostaje zgodnie z rozporządzeniem (UE) nr 305/2011 na wyłączną odpowiedzialność producenta określonego powyżej.

W imieniu producenta podpisał(-a):



Dr.-Ing. Oliver Geibig, Dyrektor Zarządzający ds. Jednostek Biznesowych i Inżynierii  
Tumlingen, 2021-05-17



Jürgen Grün, Dyrektor Zarządzający ds. Chemii i Jakości

Niniejsza Deklaracja Właściwości Użytkowych została przygotowana w różnych językach. W razie wątpliwości w interpretacji, wersja angielska jest zawsze miarodajna.

Załącznik zawiera dobrowolne i uzupełniające informacje w języku angielskim (neutralne językowo), a wykraczające poza wymagania prawne.

## I. SPECIFIC PARTS OF THE EUROPEAN TECHNICAL ASSESSMENT

### 1 Technical description of the product

- 1) fischer FiAM Intumescent Acoustic Mastic is an acrylic based sealant used to form linear gap seals where gaps are presented in wall and floor constructions and linear joint seals where wall and floor constructions abut.
- 2) fischer FiAM Intumescent Acoustic Mastic is supplied in liquid form contained within 310 ml & 380 ml cartridges, 600 ml foils or in 5, 10, 20 or 25 litre tubs. The sealant is gunned or trowelled into the aperture in or between the separating element/elements to a specified depth using various backing materials.
- 3) The applicant has submitted a written declaration that fischer FiAM Intumescent Acoustic Mastic does not contain substances which have to be classified as dangerous according to article 59 (1, 10) of the Regulation (EC) No 1907/2006 (REACH).

In addition to the specific clauses relating to dangerous substances contained in this European technical Assessment, there may be other requirements applicable to the products falling within its scope (e.g. transposed European legislation and national laws, regulations and administrative provisions). In order to meet the provisions of the Construction Products Regulation, these requirements need also to be complied with, when and where they apply.

- 4) The use category of fischer FiAM Intumescent Acoustic Mastic in relation to BWR 3 (Hygiene, health and environment) is IA2

## **2 Specification of the intended uses of the product in accordance with the applicable European Assessment Document (Hereinafter EAD)**

Detailed information and data is given in Annex A.

- 1) The intended use of system fischer FiAM Intumescent Acoustic Mastic is to reinstate the fire resistance performance of gaps in and joints in and between flexible and rigid wall constructions, gaps in and joints between rigid floor constructions.
- 2) The specific elements of construction that the system fischer FiAM Intumescent Acoustic Mastic may be used to provide a gap or joint seal in, are as follows:
  - a. Flexible walls: The wall must have a minimum thickness of 75 mm and comprise steel studs or timber studs lined on both faces with minimum 1 layer of 12.5 mm thick boards.
  - b. Rigid walls: The wall must have a minimum thickness of 75 mm and comprise concrete, aerated concrete or masonry with a minimum density of 650 kg/m<sup>3</sup>.
  - c. Rigid floors: The floor must have a minimum thickness of 150 mm and comprise aerated concrete or concrete with a minimum density of 650 kg/m<sup>3</sup>.

The supporting construction must be classified in accordance with EN 13501-2 for the required fire resistance period.

- 3) The System fischer FiAM Intumescent Acoustic Mastic may be used to provide a linear joint or gap seal with specific supporting constructions and substrates (for details see Annex A).
- 4) The maximum permitted joint/gap width for system fischer FiAM Intumescent Acoustic Mastic is 60 mm.
- 5) The maximum movement capability of system fischer FiAM Intumescent Acoustic Mastic is  $\leq 7.5\%$  depending on the application and installation (for details see Annex A).
- 6) The provisions made in this European Technical Assessment are based on an assumed working life of the fischer FiAM Intumescent Acoustic Mastic of 25 years, provided that the conditions laid down in the product datasheet for the packaging/transport/ storage/installation/use/repair are met. The indications given on the working life cannot be interpreted as a guarantee given by the producer or the Technical Assessment Body, but are to be regarded only as a means for choosing the right products in relation to the expected economically reasonable working life of the works.
- 7) Type X: Intended for use in conditions exposed to weathering and all lower classes.

**3 Performance of the product and references to the methods used for its assessment**

Product-type: Intumescent sheet	Intended use: Penetration Seal
Essential characteristic	Product performance
<b>BWR 2 Safety in case of fire</b>	
Reaction to fire	No performance assessed
Resistance to fire	Annex A
<b>BWR 3 Hygiene, health and environment</b>	
Content, emission and/or release of dangerous substances	Use categories: IA2 Declaration of manufacturer
Air permeability (material property)	Annex B
Water permeability (material property)	No performance assessed
<b>BWR 4 Safety in use</b>	
Mechanical resistance and stability	No performance assessed
Resistance to impact/movement	No performance assessed
Adhesion	7.5P
Durability	Type X
Movement capacity	Annex A
Cycling of perimeter seals for curtain walls	No performance assessed
Compression set	No performance assessed
Linear expansion on setting	No performance assessed
<b>BWR 5 Protection against noise</b>	
Airborne sound insulation	Annex C
<b>BWR 6 Energy economy and heat retention</b>	
Thermal properties	No performance assessed
Water vapour permeability	No performance assessed

**4 ASSESSMENT AND VERIFICATION OF CONSTANCY OF PERFORMANCE (HEREINAFTER AVCP) SYSTEM APPLIED, WITH REFERENCE TO ITS LEGAL BASE**

According to the decision 1999/454/EC – Commission Decision of date 22nd June 1999 on the procedure for attesting the conformity of construction products pursuant to Article 20(2) of Council Directive 89/106/EEC as regards fire stopping, fire sealing and fire protective products, published in the Official Journal of the European Union (OJEU) L178/52 of 14/07/1999, (see <https://eur-lex.europa.eu/oj/direct-access.html>) of the European Commission<sup>1</sup>, as amended, the system(s) of assessment and verification of constancy of performance (see Annex V to Regulation (EU) No 305/2011) given in the following table(s) applies (apply).

<b>Product(s)</b>	<b>Intended use(s)</b>	<b>Level(s) or class(es)</b>	<b>System(s)</b>
Fire stopping and Fire Sealing Products	For fire compartmentation and/or fire protection or fire performance	Any	1

---

<sup>1</sup> Official Journal of the European Communities L178/52 of 14/7/1999

# ANNEX A – Resistance to Fire Classification – fischer FiAM Intumescent Acoustic Mastic

## A.1 Flexible and rigid wall constructions with wall thickness of minimum 75 mm

### A.1.1 Double sided linear joint seal

**Joint Seal:** fischer FiAM Intumescent Acoustic Mastic sealant to both sides of the wall, backed with a 50 mm depth of stone wool or ceramic wool (45kg/m<sup>3</sup>), joint widths up to 25 mm.

Construction details:

Key:

1. fischer FiAM Intumescent Acoustic Mastic Sealant
2. Backing Material
3. Flexible Wall

#### A.1.1.1

Substrate	Depth (mm)	Backing Material	Classification
Flexible / flexible	12.5	Stone wool or ceramic wool (50mm 45kg/m <sup>3</sup> )	E 60 – V – X – F – W 00 to W 25 EI 45 – V – X – F – W 00 to W 25
Masonry / masonry			

## A.2 Flexible and rigid wall constructions with wall thickness of minimum 120 mm

### A.2.1 Double sided linear joint seal

**Joint Seal:** fischer FiAM Intumescent Acoustic Mastic sealant to both sides of the wall, backed with PE backing rod, glass wool, stone wool or ceramic wool, joint widths up to 20 mm.

<p>Construction details:</p>	<p>Key:</p> <ol style="list-style-type: none"> <li>1. <u>fischer FiAM Intumescent Acoustic Mastic Sealant</u></li> <li>2. <u>Backing Material</u></li> <li>3. <u>Flexible Wall</u></li> </ol>
------------------------------	---

#### A.2.1.1

Substrate	Depth (mm)	Backing Material	Classification
Flexible / flexible	12.5	PE backing rod, glass wool, stone wool or ceramic wool	EI 120 – V – X – F – W 00 to W 20
Masonry / masonry			

## A.2.2 Double sided head of wall joint seal

**Joint Seal:** fischer FiAM Intumescent Acoustic Mastic sealant to both sides of the wall, joint widths up to 20 mm.

Construction details:

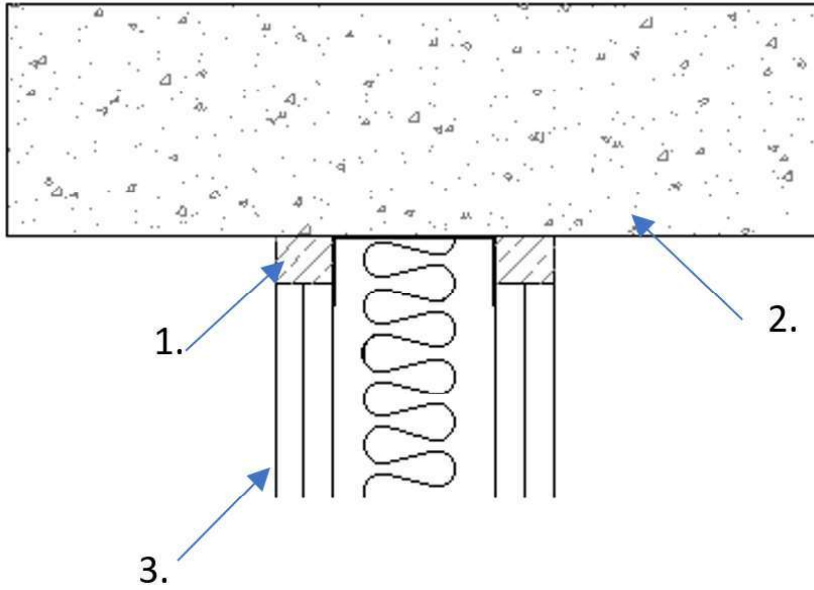

Key:

1. fischer FiAM Intumescent Acoustic Mastic Sealant
2. Rigid Floor
3. Flexible Wall

### A.2.2.1

Substrate	Depth (mm)	Backing Material	Classification
Flexible / concrete	25	Steel head track	EI 120 – T – X – F – W 00 to W 20
Masonry / concrete			



### A.3 Rigid wall constructions with wall thickness of minimum 100 mm

#### A.3.1 Single sides linear joint seal

**Joint Seal:** fischer FiAM Intumescent Acoustic Mastic sealant to either side of the wall, joint widths up to 50 mm.

Construction details:

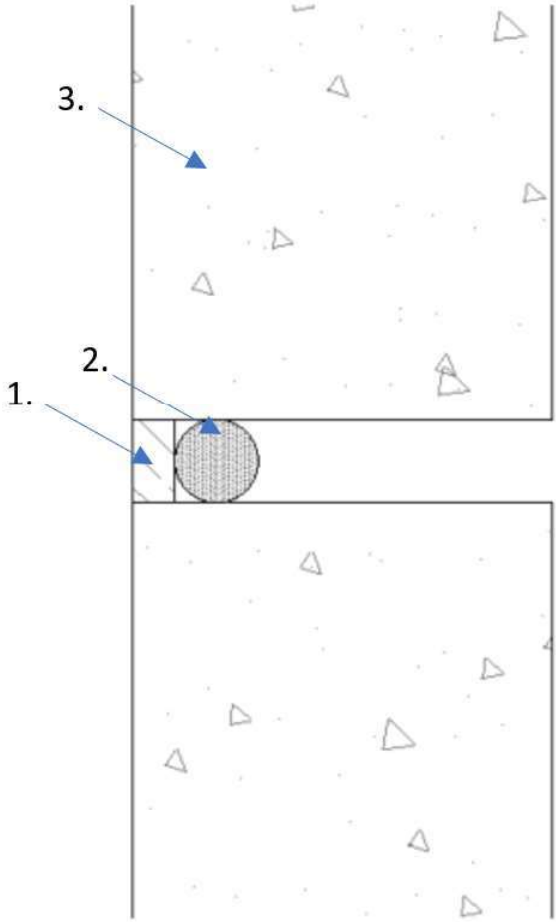

Key:

1. fischer FiAM Intumescent Acoustic Mastic Sealant Installed Either Side of Wall
2. Backing Material
3. Rigid Wall

##### A.3.1.1

Substrate	Depth (mm)	Backing Material	Classification
Concrete / masonry	25	PE backing rod, glass wool, stone wool or ceramic wool	E 120 – V – X – F – W 00 to W 50 EI 60 – V – X – F – W 00 to W 50
	2:1 ratio (width:depth) & Min. 10		E 120 – V – X – F – W 00 to W 50 EI 45 – V – X – F – W 00 to W 50

### A.3.2 Single sided linear joint seal with steel faced wall

**Joint Seal:** fischer FiAM Intumescent Acoustic Mastic sealant to either side of the wall.

Construction details:

Key:

- fischer FiAM Intumescent Acoustic Mastic Sealant Installed Either Side of Wall
- Backing Material
- Rigid Wall
- Steel

#### A.3.2.1

Substrate	Depth (mm)	Backing Material	Classification
Concrete or masonry / steel	10	PE backing rod, glass wool, stone wool or ceramic wool	E 120 – V – X – F – W 00 to W 20 EI 20 – V – X – F – W 00 to W 20
	2:1 ratio (width:depth) & Min. 10		E 45 – V – X – F – W 00 to W 50 EI 20 – V – X – F – W 00 to W 50

### A.3.3 Single sided linear joint seal with timber faced wall

**Joint Seal:** fischer FiAM Intumescent Acoustic Mastic sealant to either side of the wall, joint widths up to 50 mm.

Construction details:

Key:

- fischer FiAM Intumescent Acoustic Mastic Sealant Installed Either Side of Wall
- Backing Material
- Rigid Wall
- Timber

#### A.3.3.1

Substrate	Depth (mm)	Backing Material	Classification
Concrete or masonry / timber	2:1 ratio (width:depth) & Min. 10	PE backing rod, glass wool, stone wool or ceramic wool	E 30 – V – X – F – W 00 to W 50 EI 20 – V – X – F – W 00 to W 50
	25		EI 45 – V – X – F – W 00 to W 50

## A.4 Rigid wall constructions with wall thickness of minimum 150 mm

### A.4.1 Double sided linear joint seal

**Joint Seal:** fischer FiAM Intumescent Acoustic Mastic sealant to both sides of the wall, joint widths up to 60 mm.

Construction details:

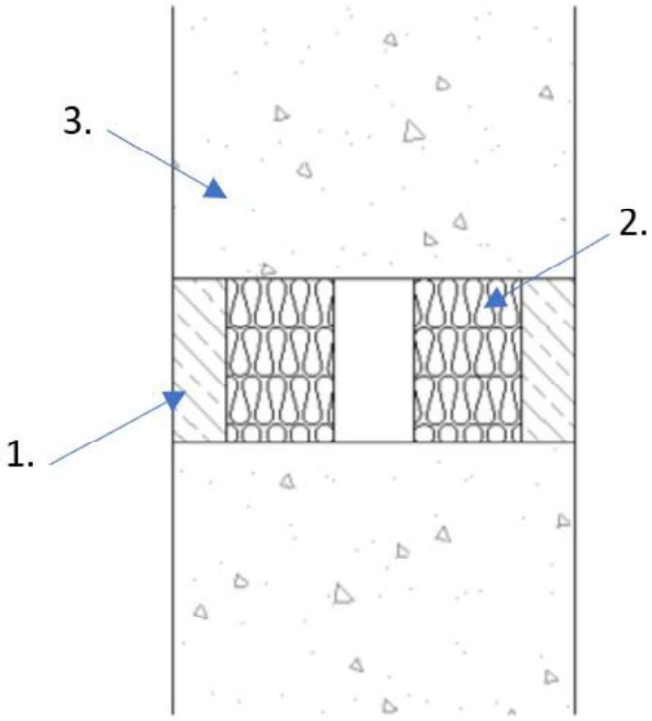

Key:

1. fischer FiAM Intumescent Acoustic Mastic Sealant
2. Backing Material
3. Rigid Wall

#### A.4.1.1

Substrate	Depth (mm)	Backing Material	Classification
Concrete / masonry	30	Stone wool or ceramic wool ( $\geq 40\text{mm}$ $\geq 45\text{kg/m}^3$ )	EI 240 – V – X – F – W 00 to W 60

#### A.4.2 Double sided linear joint seal

**Joint Seal:** fischer FiAM Intumescent Acoustic Mastic sealant to both sides of the wall, joint widths up to 50 mm.

Construction details:

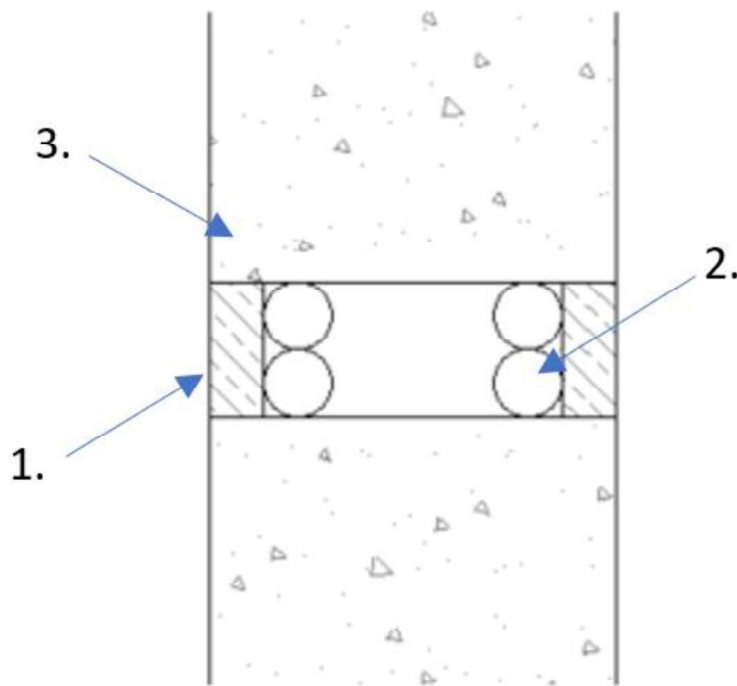

Key:

1. fischer FiAM Intumescent Acoustic Mastic Sealant
2. Backing Material
3. Rigid Wall

##### A.4.2.1

Substrate	Depth (mm)	Backing Material	Classification
Concrete / masonry	25	PE backing rod, glass wool, stone wool or ceramic wool	EI 240 – V – X – F – W 00 to W 50

### A.4.3 Double sided linear joint seal with steel faced wall

**Joint Seal:** fischer FiAM Intumescent Acoustic Mastic sealant to both sides of the wall, joint widths up to 60 mm.

Construction details:

Key:

1. fischer FiAM Intumescent Acoustic Mastic Sealant
2. Backing Material
3. Rigid Wall
4. Steel

#### A.4.3.1

Substrate	Depth (mm)	Backing Material	Classification
Concrete or masonry / steel	30	Stone wool or ceramic wool ( $\geq 40\text{mm}$ $\geq 45\text{kg/m}^3$ )	E 240 – V – X – F – W 00 to W 60 EI 60 – V – X – F – W 00 to W 60

#### A.4.4 Double sided linear joint seal with timber faced wall

**Joint Seal:** fischer FiAM Intumescent Acoustic Mastic sealant to both sides of the wall, joint widths up to 60 mm.

Construction details:

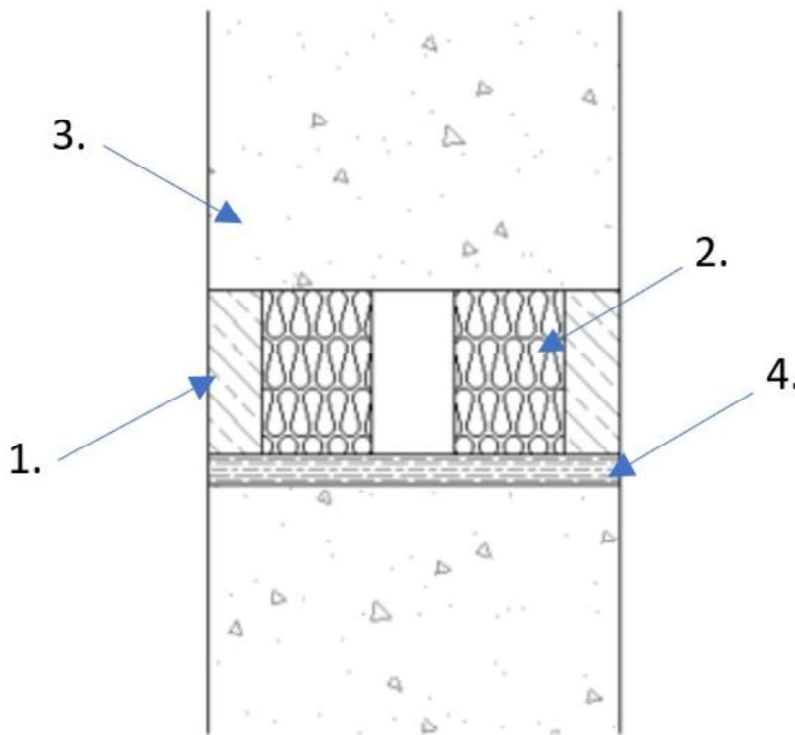

Key:

1. fischer FiAM Intumescent Acoustic Mastic Sealant
2. Backing Material
3. Rigid Wall
4. Timber

##### A.4.4.1

Substrate	Depth (mm)	Backing Material	Classification
Concrete or masonry / timber	30	Stone wool or ceramic wool ( $\geq 40\text{mm} \geq 45\text{kg/m}^3$ )	EI 60 – V – X – F – W 00 to W 60

#### A.4.5 Double sided linear joint seal with movement

**Joint Seal:** fischer FiAM Intumescent Acoustic Mastic sealant to both sides of the wall, joint widths up to 60 mm.

Construction details:

Key:

1. fischer FiAM Intumescent Acoustic Mastic Sealant
2. Backing Material
3. Rigid Wall

##### A.4.5.1

Substrate	Depth (mm)	Backing Material	Classification
Concrete / masonry	20	PE backing rod, glass wool, stone wool or ceramic wool	E 240 – V – M 25 – F – W 00 to W 60 EI 120 – V – M 25 – F – W 00 to W 60



### A.4.6 Single sided linear joint seal with movement

**Joint Seal:** fischer FiAM Intumescent Acoustic Mastic sealant either side of the wall, joint widths up to 60 mm.

Construction details:

Key:

1. fischer FiAM Intumescent Acoustic Mastic Sealant Installed Either Side of Wall
2. Backing Material
3. Rigid Wall

#### A.4.6.1

Substrate	Depth (mm)	Backing Material	Classification
Concrete / masonry	5	Stone wool or ceramic wool ( $\geq 75\text{mm}$ $\geq 60\text{kg/m}^3$ , compressed to 60%)	E 240 – V – M 25 – F – W 00 to W 60 EI 120 – V – M 25 – F – W 00 to W 60

## A.5 Rigid floor constructions with floor depth of minimum 150 mm

### A.5.1 Single sided linear joint seal in floor from underside

**Joint Seal:** fischer FiAM Intumescent Acoustic Mastic sealant flush to the underside of the floor, joint widths up to 50 mm.

Construction details:

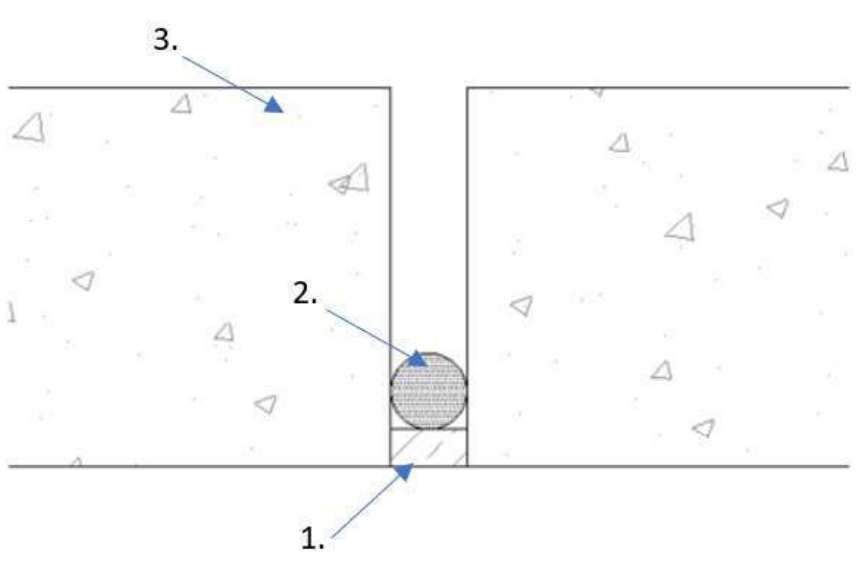

Key:

- fischer FiAM Intumescent Acoustic Mastic Sealant
- Backing Material
- Rigid Floor

#### A.5.1.1

Substrate	Depth (mm)	Backing Material	Classification
Concrete / masonry	25	PE backing rod, glass wool, stone wool or ceramic wool	E 240 – H – X – F – W 00 to W 50 EI 90 – H – X – F – W 00 to W 50
	2:1 ratio (width:depth) & Min. 10		E 240 – H – X – F – W 00 to W 50 EI 45 – H – X – F – W 00 to W 50

### A.5.2 Single sided linear joint seal in floor from top side

**Joint Seal:** fischer FiAM Intumescent Acoustic Mastic sealant flush to the top side of the floor, joint widths up to 50 mm.

<p>Construction details:</p>	<p>Key:</p> <ol style="list-style-type: none"> <li>1. <u>fischer FiAM Intumescent Acoustic Mastic Sealant</u></li> <li>2. <u>Backing Material</u></li> <li>3. <u>Rigid Floor</u></li> </ol>
------------------------------	---

#### A.5.2.1

Substrate	Depth (mm)	Backing Material	Classification
Concrete / masonry	25	PE backing rod, glass wool, stone wool or ceramic wool	E 240 – H – X – F – W 00 to W 50 EI 90 – H – X – F – W 00 to W 50
	2:1 ratio (width:depth) & Min. 10		E 240 – H – X – F – W 00 to W 50 EI 45 – H – X – F – W 00 to W 50

### A.5.3 Single sided linear joint seal in steel faced floor from underside

**Joint Seal:** fischer FiAM Intumescent Acoustic Mastic sealant flush to the underside of the floor, joint widths up to 50 mm.

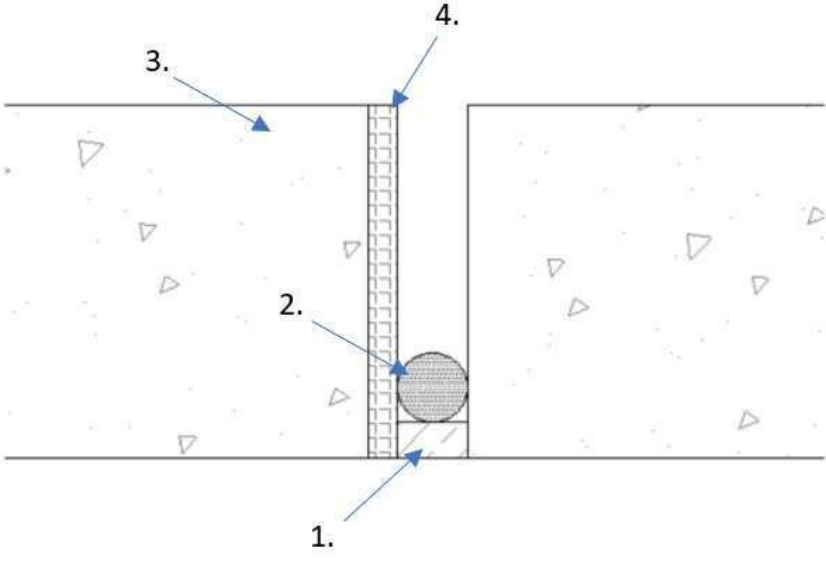
<p>Construction details:</p> 	<p>Key:</p> <ol style="list-style-type: none"> <li>1. <u>fischer FiAM Intumescent Acoustic Mastic Sealant</u></li> <li>2. <u>Backing Material</u></li> <li>3. <u>Rigid Floor</u></li> <li>4. <u>Steel</u></li> </ol>
---	--

#### A.5.3.1

Substrate	Depth (mm)	Backing Material	Classification
Concrete or masonry / steel	25	PE backing rod, glass wool, stone wool or ceramic wool	E 240 – H – X – F – W 00 to W 50 EI 90 – H – X – F – W 00 to W 50
	2:1 ratio (width:depth) & Min. 10		E 120 – H – X – F – W 00 to W 50 EI 30 – H – X – F – W 00 to W 50

### A.5.4 Single sided linear joint seal in steel faced floor from top side

**Joint Seal:** fischer FiAM Intumescent Acoustic Mastic sealant flush to the top side of the floor, joint widths up to 50 mm.

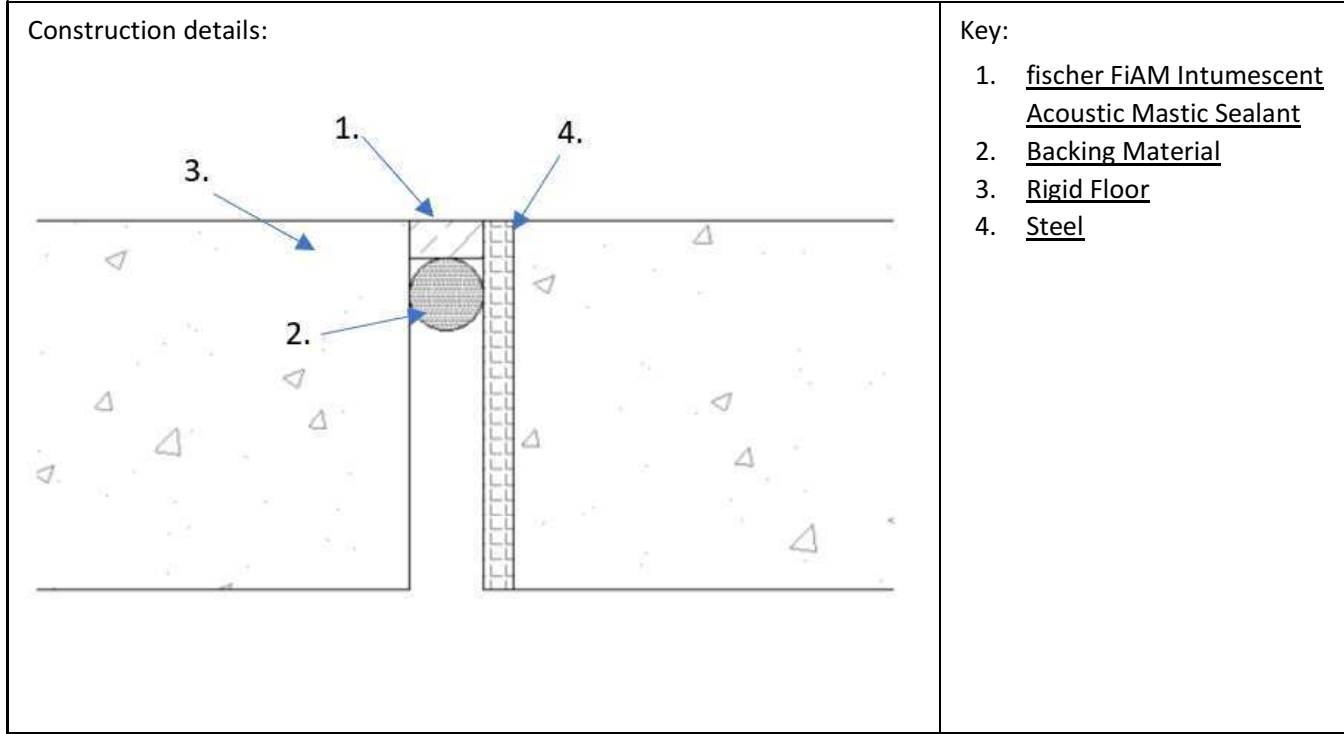

#### A.5.4.1

Substrate	Depth (mm)	Backing Material	Classification
Concrete or masonry / steel	25	PE backing rod, glass wool, stone wool or ceramic wool	E 240 – H – X – F – W 00 to W 50 EI 90 – H – X – F – W 00 to W 50
	2:1 ratio (width:depth) & Min. 10		E 120 – H – X – F – W 00 to W 50 EI 30 – H – X – F – W 00 to W 50

### A.5.5 Single sided linear joint seal in timber faced floor from underside

**Joint Seal:** fischer FiAM Intumescent Acoustic Mastic sealant flush to the underside of the floor, joint widths up to 50 mm.

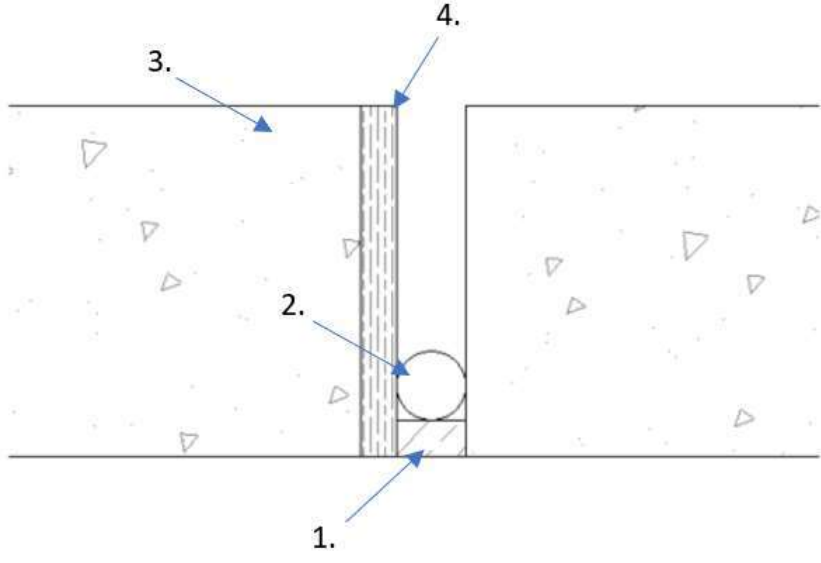
<p>Construction details:</p> 	<p>Key:</p> <ol style="list-style-type: none"> <li>1. <u>fischer FiAM Intumescent Acoustic Mastic Sealant</u></li> <li>2. <u>Backing Material</u></li> <li>3. <u>Rigid Floor</u></li> <li>4. <u>Timber</u></li> </ol>
---	---

#### A.5.5.1

Substrate	Depth (mm)	Backing Material	Classification
Concrete or masonry / timber	25	PE backing rod, glass wool, stone wool or ceramic wool	EI 45 – H – X – F – W 00 to W 50
	2:1 ratio (width:depth) & Min. 10		EI 30 – H – X – F – W 00 to W 50

### A.5.6 Single sided linear joint seal in timber faced floor from top side

**Joint Seal:** fischer FiAM Intumescent Acoustic Mastic sealant flush to the top side of the floor, joint widths up to 50 mm.

<p>Construction details:</p>	<p>Key:</p> <ol style="list-style-type: none"> <li>1. <u>fischer FiAM Intumescent Acoustic Mastic Sealant</u></li> <li>2. <u>Backing Material</u></li> <li>3. <u>Rigid Floor</u></li> <li>4. <u>Timber</u></li> </ol>
------------------------------	---

#### A.5.6.1

Substrate	Depth (mm)	Backing Material	Classification
Concrete or masonry / timber	25	PE backing rod, glass wool, stone wool or ceramic wool	EI 45 – H – X – F – W 00 to W 50
	2:1 ratio (width:depth) & Min. 10		EI 30 – H – X – F – W 00 to W 50

### A.5.7 Single sided linear joint seal in floor from top side with movement

**Joint Seal:** fischer FiAM Intumescent Acoustic Mastic sealant flush to the top side of the floor, joint widths up to 60 mm.

Construction details:

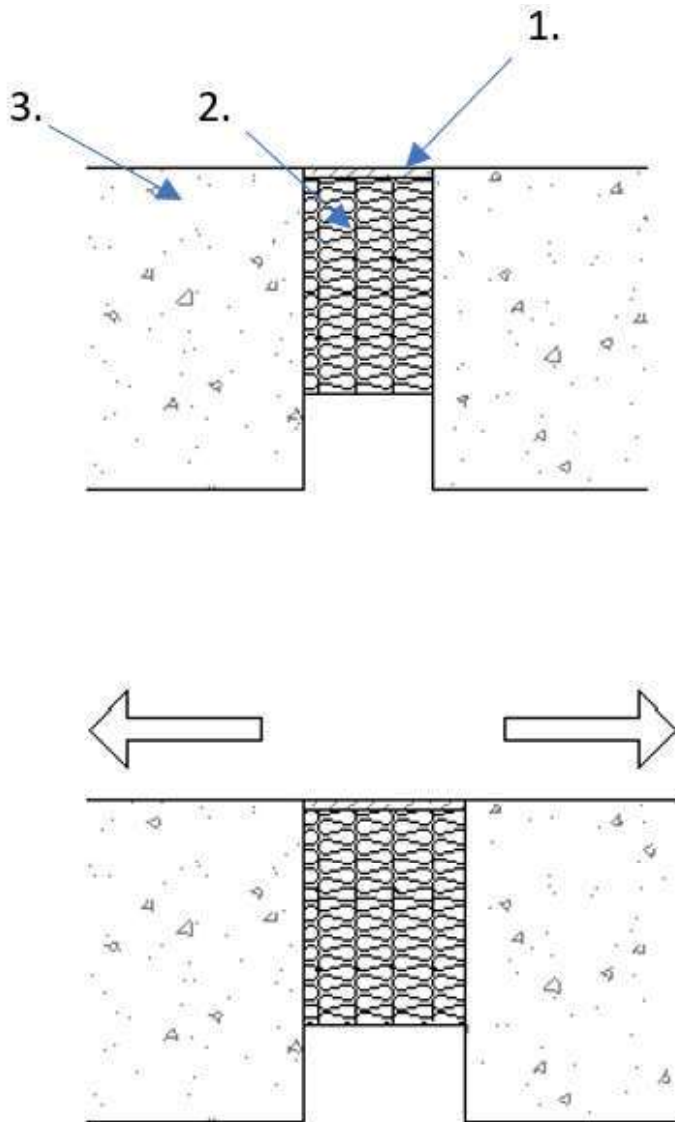

Key:

1. fischer FiAM Intumescent Acoustic Mastic Sealant
2. Backing Material
3. Rigid Floor

#### A.5.7.1

Substrate	Depth (mm)	Backing Material	Classification
Concrete / masonry	5	Stone wool or ceramic wool ( $\geq 100\text{mm}$ $\geq 60\text{kg/m}^3$ , compressed to 60%)	EI 240 – H – M 25 – F – W 00 to W 60



### A.5.8 Double sided linear joint seal in floor with movement

**Joint Seal:** fischer FiAM Intumescent Acoustic Mastic sealant to both sides of the floor, joint widths up to 60 mm.

Construction details:

Key:

1. fischer FiAM Intumescent Acoustic Mastic Sealant
2. Backing Material
3. Rigid Floor

#### A.5.8.1

Substrate	Depth (mm)	Backing Material	Classification
Concrete / masonry	20	PE backing rod, glass wool, stone wool or ceramic wool	E 240 – H – M 17 – F – W 00 to W 60 EI 60 – H – M 17 – F – W 00 to W 60

## A.6 Head of wall with thickness of minimum 150 mm

### A.6.1 Single sided head of wall joint in floor

**Joint Seal:** fischer FiAM Intumescent Acoustic Mastic sealant to either side of the wall, joint widths up to 50 mm.

Construction details:

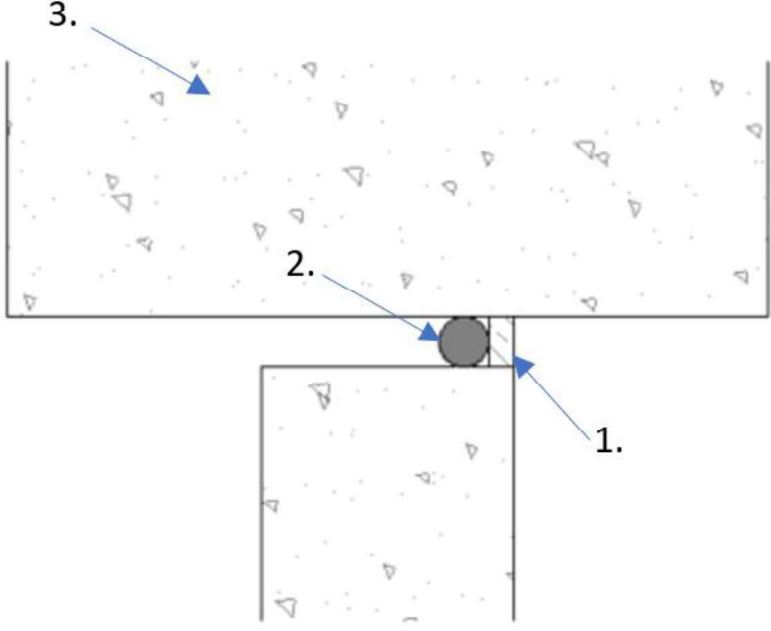

Key:

- fischer FiAM Intumescent Acoustic Mastic Sealant Installed Either Side of Wall
- Backing Material
- Rigid Floor

#### A.6.1.1

Substrate	Depth (mm)	Backing Material	Classification
Concrete / masonry	25	PE backing rod, glass wool, stone wool or ceramic wool	E 240 – T – X – F – W 00 to W 50 EI 90 – T – X – F – W 00 to W 50
	2:1 ratio (width:depth) & Min. 10		E 240 – T – X – F – W 00 to W 50 EI 45 – T – X – F – W 00 to W 50

### A.6.2 Single sided head of wall joint with steel face

**Joint Seal:** fischer FiAM Intumescent Acoustic Mastic sealant to either side of the wall, joint widths up to 50 mm.

Construction details:

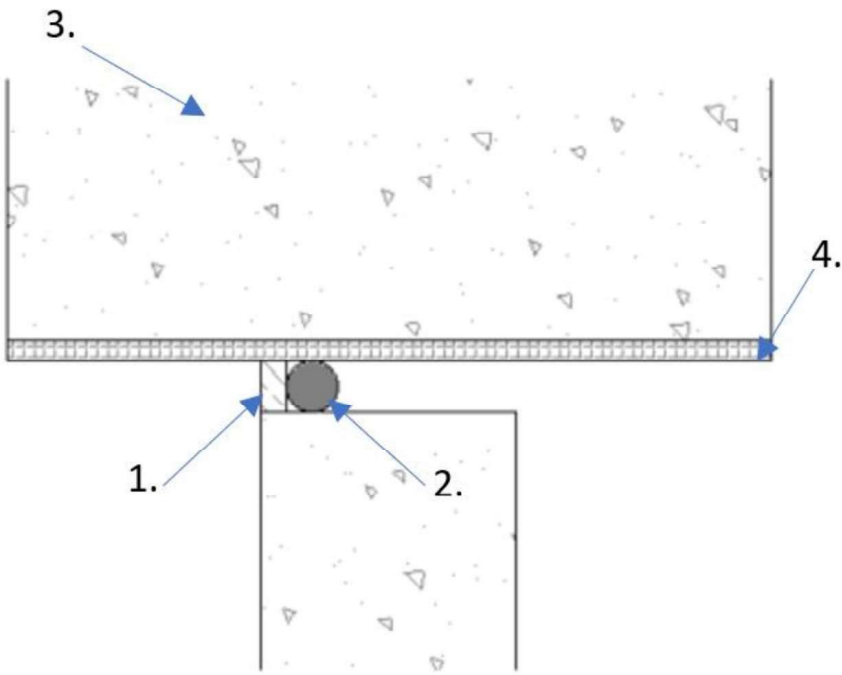

Key:

1. fischer FiAM Intumescent Acoustic Mastic Sealant Installed Either Side of Wall
2. Backing Material
3. Rigid Floor
4. Steel

#### A.6.2.1

Substrate	Depth (mm)	Backing Material	Classification
Concrete or masonry / steel	25	PE backing rod, glass wool, stone wool or ceramic wool	E 240 – T – X – F – W 00 to W 50 EI 90 – T – X – F – W 00 to W 50
	2:1 ratio (width:depth) & Min. 10		E 240 – T – X – F – W 00 to W 50 EI 30 – T – X – F – W 00 to W 50

### A.6.3 Single sided head of wall joint with timber face

**Joint Seal:** fischer FiAM Intumescent Acoustic Mastic sealant to either side of the wall, joint widths up to 50 mm.

Construction details:

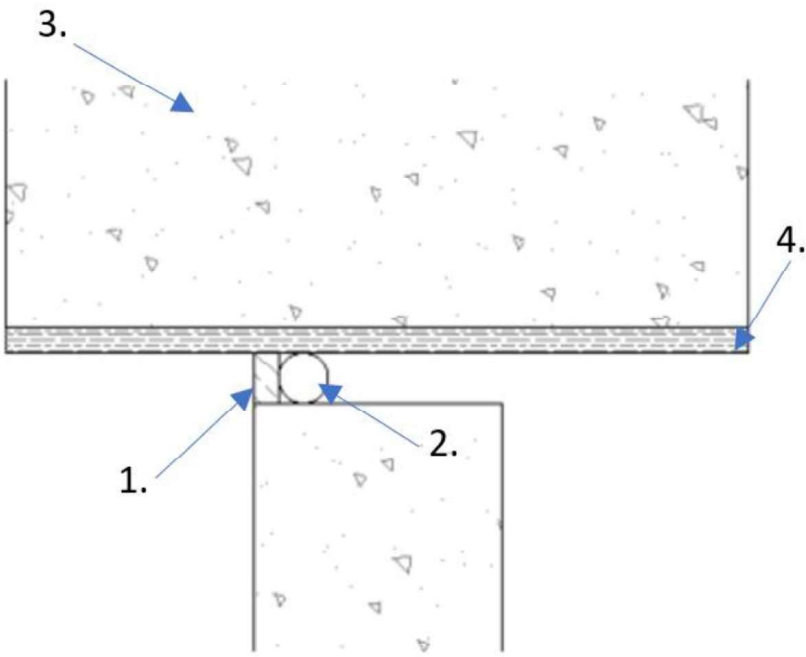

Key:

1. fischer FiAM Intumescent Acoustic Mastic Sealant Installed Either Side of Wall
2. Backing Material
3. Rigid Floor
4. Timber

#### A.6.3.1

Substrate	Depth (mm)	Backing Material	Classification
Concrete or masonry / timber	25	PE backing rod, glass wool, stone wool or ceramic wool	EI 45 – T – X – F – W 00 to W 50
	2:1 ratio (width:depth) & Min. 10		EI 30 – T – X – F – W 00 to W 50

### A.6.4 Double sided head of wall joint with movement

**Joint Seal:** fischer FiAM Intumescent Acoustic Mastic sealant to both sides of the wall, joint widths up to 60 mm.

Construction details:

Key:

1. fischer FiAM Intumescent Acoustic Mastic Sealant
2. Backing Material
3. Rigid Floor

#### A.6.4.1

Substrate	Depth (mm)	Backing Material	Classification
Concrete / masonry	20	PE backing rod, glass wool, stone wool or ceramic wool	E 240 – T – M 17 – F – W 00 to W 60 EI 60 – T – M 17 – F – W 00 to W 60

### A.6.5 Double sided head of wall joint with movement

**Joint Seal:** fischer FiAM Intumescent Acoustic Mastic sealant to both sides of the wall, joint widths up to 60 mm.

Construction details:

Key:

1. fischer FiAM Intumescent Acoustic Mastic Sealant
2. Backing Material
3. Rigid Floor

#### A.6.5.1

Substrate	Depth (mm)	Backing Material	Classification
Concrete / masonry	5	Stone wool or ceramic wool (≥70mm (x2) ≥60kg/m <sup>3</sup> , compressed to 60%)	EI 240 – T – M 25 – F – W 00 to W 60

# ANNEX B – Air Permeability - fischer FiAM Intumescent Acoustic Mastic

Product tested	25 mm thick x 30 mm wide fischer FiAM Intumescent Acoustic Mastic intumescent sealant		
Summary of testing procedure			Result
	Pressure (Pa)	Leakage (m <sup>3</sup> /h)	Leakage (m <sup>3</sup> /m <sup>2</sup> /h)
Results under negative chamber pressure	50	0.0	0.0
	100	0.0	0.0
	150	0.1	2.8
	200	0.1	2.8
	250	0.1	2.8
	300	0.0	0.0
	450	0.1	2.8
	600	0.1	2.8
Results under positive chamber pressure	50	0.0	0.0
	100	0.0	0.0
	150	0.0	0.0
	200	0.0	0.0
	250	0.0	0.0
	300	0.0	0.0
	450	0.1	2.8
	600	0.1	2.8

# ANNEX C – Airborne Sound Insulation - fischer FiAM Intumescent Acoustic Mastic

## C.1 fischer FiAM Intumescent Acoustic Mastic sealant at 15 mm deep in the following configuration

### FiAM MASTIC SEALANT TESTED TO EN 10140-2:2010 THROUGH A FLEXIBLE CONSTRUCTION

ACOUSTIC TEST RESULTS	
Partition & Sealant Result	63 Rw dB
Sealant Result	51 Rw dB
Sealant Result	61 Dnew dB

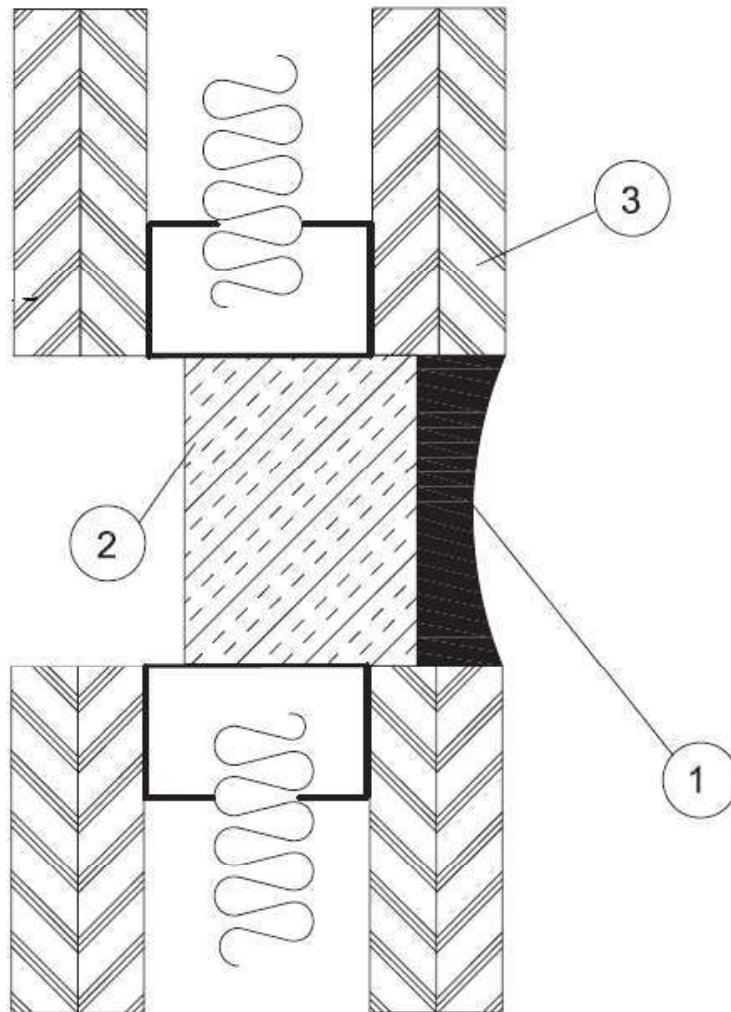

- 1 - FiAM MASTIC SEALANT TO ONE SIDE OF WALL 15mm DEPTH
- 2 - 55mm DEPTH STONE WOOL 60kg DENSITY
- 3 - CONSTRUCTING ELEMENT RATED TO 65 dB

BWR 5 Protection against noise		
Assessment method	Essential characteristic	Product performance
EN 10140-1,2,4,5/ EN ISO 717-1	Airborne sound insulation	Rw (C;Ctr)= 63(-1;-7)



**C.2 fischer FiAM Intumescent Acoustic Mastic sealant at 25 mm deep in the following configuration**

**FiAM MASTIC SEALANT TESTED TO EN 10140-2:2010 THROUGH A FLEXIBLE CONSTRUCTION**

ACOUSTIC TEST RESULTS	
Partition & Sealant Result	63 Rw dB
Sealant Result	51 Rw dB
Sealant Result	61 Dnew dB

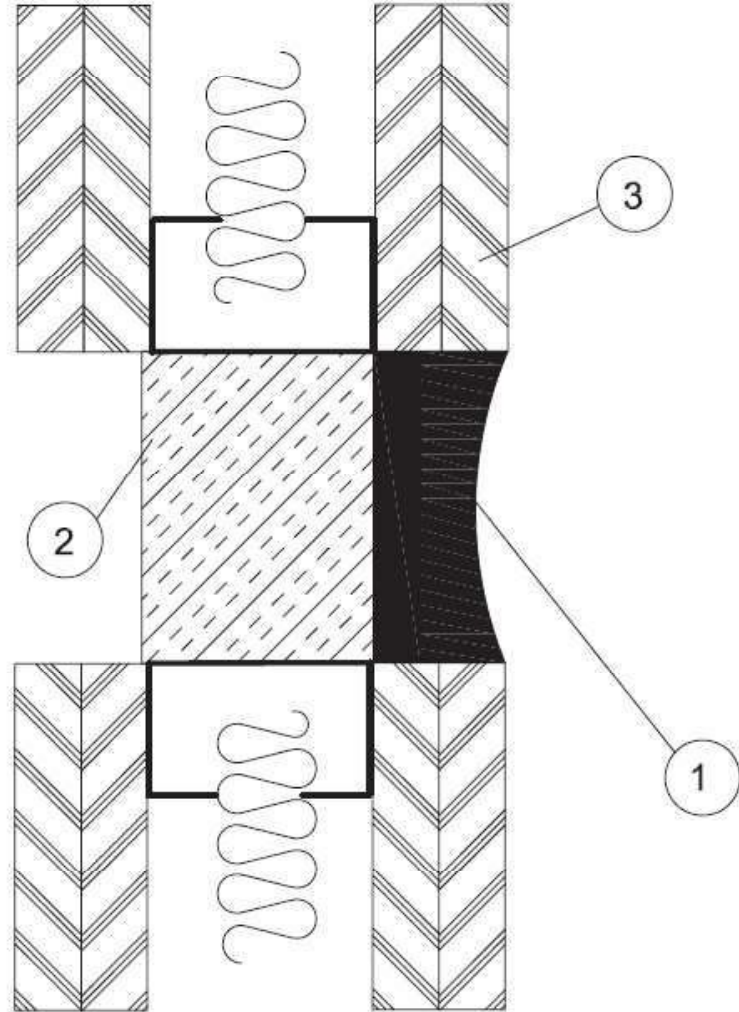

- 1 - FiAM MASTIC SEALANT TO ONE SIDE OF WALL 25mm DEPTH
- 2 - 55mm DEPTH STONE WOOL 60kg DENSITY
- 3 - CONSTRUCTING ELEMENT RATED TO 65 dB

BWR 5 Protection against noise		
Assessment method	Essential characteristic	Product performance
EN 10140-1,2,4,5/ EN ISO 717-1	Airborne sound insulation	Rw (C;Ctr)= 63(-1;-7)