



PRESTATIEVERKLARING



Nr. 0111 – NL

1. Unieke identificatiecode van het producttype: **fischer Superbond**

2. Beoogd(e) gebruik(en):

Product	Beoogd gebruik
Lijm anker te gebruiken in beton	Voor bevestigen van constructieve elementen of veiligheidsrelevante onderdelen zoals verlaagde plafonds aan beton, zie bijlage, in het bijzonder bijlages B 1 tot en met B 15

3. Fabrikant: **fischerwerke GmbH & Co. KG, Otto-Hahn-Straße 15, 79211 Denzlingen, Duitsland**

4. Gemachtigde: --

5. Het systeem of de systemen voor de beoordeling en verificatie van de prestatiebestendigheid: **1**

6a. Geharmoniseerde norm: ---

Aangemelde instantie(s): ---

6b. Europees beoordelingsdocument: **ETAG 001, 2013-04**

Europese technische beoordeling: **ETA-12/0258; 2016-05-19**

Technische beoordelingsinstantie: **DIBt**

Aangemelde instantie(s): **1343 – MPA Darmstadt**

7. Aangegeven prestatie(s):

Mechanische weerstand en stabiliteit (BWR 1)

Essentieel kenmerk	Prestatie
Karakteristieke waarden voor statische en quasi statische belastingen voor ontwerp volgens TR 029 of of CEN/TS 1992-4:2009, Verplaatsingen; Karakteristieke weerstand voor seismische categorie C1 en C2 voor ontwerp volgens TR 045, verplaatsingen	Zie bijlage, in het bijzonder bijlages C 1 tot en met C 16

Veiligheid bij brand (BWR 2)

Essentieel kenmerk	Prestatie
Brandgedrag	Verankeringen voldoen aan de vereisten voor klasse A1
Brand weerstand	Geen prestatie bepaald (NPD)

8. Geëigende technische documentatie en/of specifieke technische documentatie: ---

De prestaties van het hierboven omschreven product zijn conform de aangegeven prestaties. Deze prestatieverklaring wordt in overeenstemming met Verordening (EU) nr. 305/2011 onder de exclusieve verantwoordelijkheid van de hierboven vermelde fabrikant verstrekt.

Ondertekend voor en namens de fabrikant door:

Andreas Bucher, Dipl.-Ing.

Wolfgang Hengesbach, Dipl.-Ing., Dipl.-Wirtsch.-Ing.

Tumlingen, 2016-06-02

- Deze prestatieverklaring is opgesteld in verschillende talen. Bij een geschil over de interpretatie prevaleert de engelse versie.

- De bijlage bevat vrijwillige en aanvullende informatie in de Engelse taal boven op de (taal-neutraal gespecificeerde) wettelijke voorschriften.

Specific Part

1 Technical description of the product

The fischer superbond is a bonded anchor for use in concrete consisting of a cartridge with injection mortar fischer FIS SB and a steel element according to Annex A2.

The steel element is placed into a drilled hole filled with injection mortar and is anchored via the bond between metal part, injection mortar and concrete.

The product description is given in Annex A.

2 Specification of the intended use in accordance with the applicable European Assessment Document

The performances given in Section 3 are only valid if the anchor is used in compliance with the specifications and conditions given in Annex B.

The verifications and assessment methods on which this European Technical Assessment is based lead to the assumption of a working life of the anchor of at least 50 years. The indications given on the working life cannot be interpreted as a guarantee given by the producer, but are to be regarded only as a means for choosing the right products in relation to the expected economically reasonable working life of the works.

3 Performance of the product and references to the methods used for its assessment

3.1 Mechanical resistance and stability (BWR 1)

Essential characteristic	Performance
Characteristic values under static and quasi-static action for design according to TR 029 or CEN/TS 1992-4:2009, Displacements; Seismic performance categories C1 and C2 for design according to Technical Report TR 045, Displacements	See Annex C 1 to C 16

3.2 Safety in case of fire (BWR 2)

Essential characteristic	Performance
Reaction to fire	Anchorage satisfy requirements for Class A1
Resistance to fire	No performance assessed

3.3 Hygiene, health and the environment (BWR 3)

Regarding dangerous substances there may be requirements (e.g. transposed European legislation and national laws, regulations and administrative provisions) applicable to the products falling within the scope of this European Technical Assessment. In order to meet the provisions of Regulation (EU) No 305/2011, these requirements need also to be complied with, when and where they apply.

3.4 Safety in use (BWR 4)

The essential characteristics regarding Safety in use are included under the Basic Works Requirement Mechanical resistance and stability.

4 Assessment and verification of constancy of performance (AVCP) system applied, with reference to its legal base

In accordance with guideline for European technical approval ETAG 001, April 2013 used as European Assessment Document (EAD) according to Article 66 Paragraph 3 of Regulation (EU) No 305/2011 the applicable European legal act is: [96/582/EC].

The system to be applied is: 1

Installation conditions

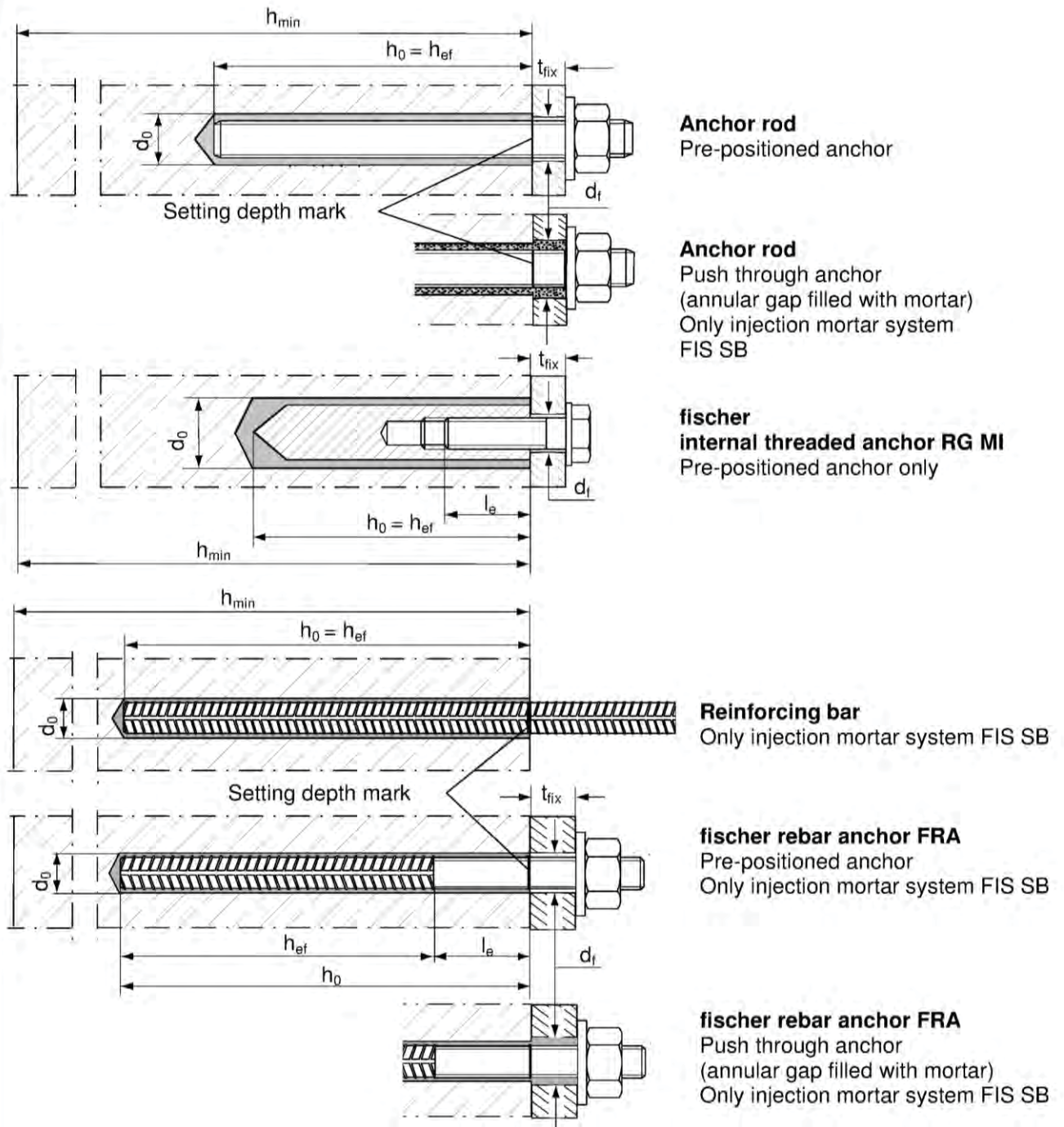

fischer Superbond

Product description
Installation conditions

Annex A 1







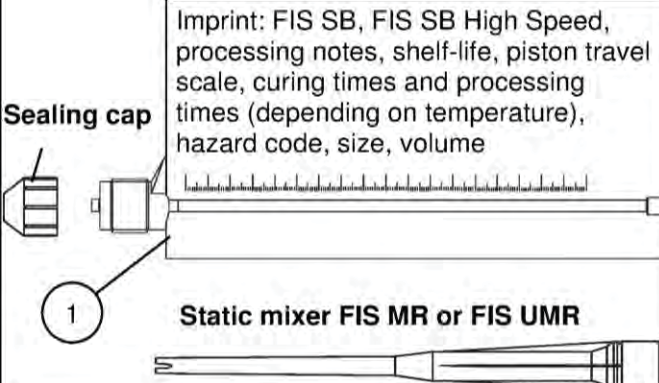
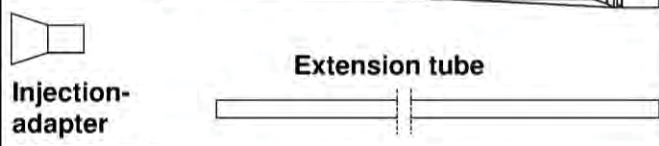
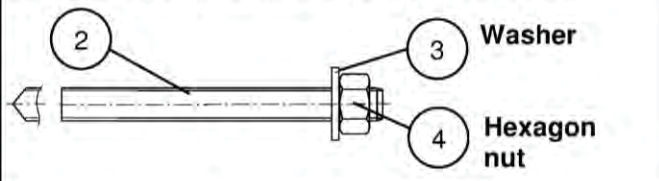
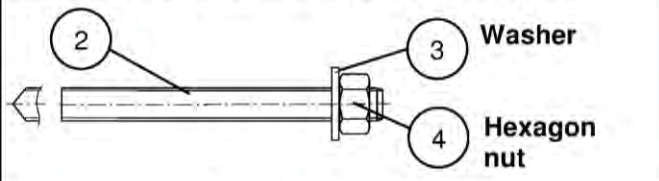
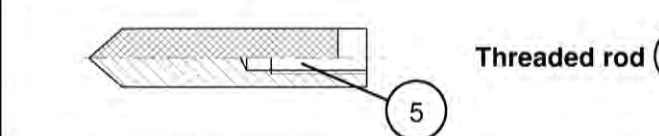
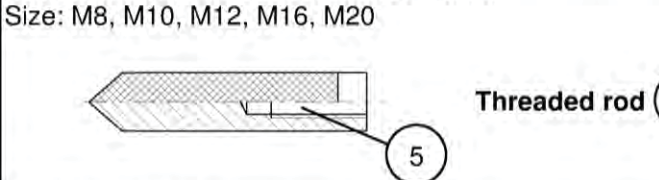
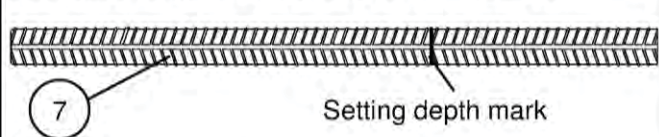
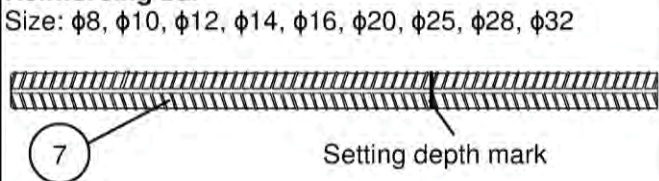
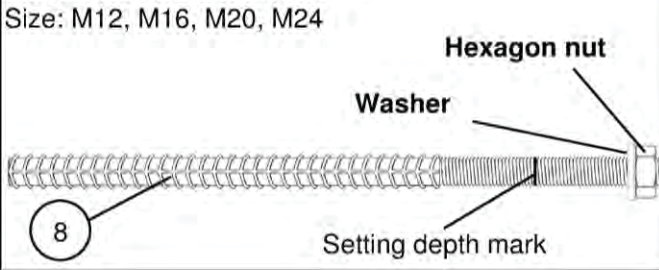

Injection system FIS SB	Resin capsule system RSB
<p>Cartridge sizes (390 ml, 585 ml, 1100 ml, 1500 ml)</p> <p>Imprint: FIS SB, FIS SB High Speed, processing notes, shelf-life, piston travel scale, curing times and processing times (depending on temperature), hazard code, size, volume</p>  <p>Sealing cap</p> <p>Static mixer FIS MR or FIS UMR</p>  <p>Injection-adapter</p> <p>Extension tube</p>	<p>Resin capsule RSB (8, 10 mini, 10, 12 mini, 12, 16 mini, 16, 16 E, 20, 20 E / 24, 30)</p>  <p>1</p>
<p>Anchor rod Size: M8, M10, M12, M16, M20, M24, M27, M30</p>  <p>2</p> <p>3 Washer</p> <p>4 Hexagon nut</p>	<p>fischer anchor rod RG M Size: M8, M10, M12, M16, M20, M24, M30</p>  <p>2</p> <p>3 Washer</p> <p>4 Hexagon nut</p>
<p>fischer internal threaded anchor RG MI Size: M8, M10, M12, M16, M20</p>  <p>5</p> <p>6 Threaded rod</p>	 <p>6 Screw</p> <p>Washer</p> <p>Hexagon nut</p>
<p>Reinforcing bar Size: $\phi 8$, $\phi 10$, $\phi 12$, $\phi 14$, $\phi 16$, $\phi 20$, $\phi 25$, $\phi 28$, $\phi 32$</p>  <p>7</p> <p>Setting depth mark</p>	
<p>fischer rebar anchor FRA Size: M12, M16, M20, M24</p>  <p>8</p> <p>Hexagon nut</p> <p>Washer</p> <p>Setting depth mark</p>	
<p>fischer Superbond</p> <hr/> <p>Product description Cartridges / resin capsule / Static mixer / Steel elements</p>	<p>Annex A 2</p>

Table A1: Materials				
Part	Designation	Material		
1	Mortar cartridge	Mortar, hardener, filler		
	Steel grade	Steel, zinc plated	Stainless steel A4	High corrosion resistant steel C
2	Anchor rod	Property class 5.8 or 8.8; EN ISO 898-1:2013 zinc plated $\geq 5 \mu\text{m}$, EN ISO 4042:1999 A2K or hot-dip galvanised EN ISO 10684:2004 $f_{uk} \leq 1000 \text{ N/mm}^2$ $A_5 > 12 \%$ fracture elongation ¹⁾	Property class 50, 70 or 80 EN ISO 3506-1:2009 1.4401; 1.4404; 1.4578; 1.4571; 1.4439; 1.4362; 1.4062, 1.4662, 1.4462 EN 10088-1:2014 $f_{uk} \leq 1000 \text{ N/mm}^2$ $A_5 > 12 \%$ fracture elongation ¹⁾	Property class 50 or 80 EN ISO 3506-1:2009 or property class 70 with $f_{yk} = 560 \text{ N/mm}^2$ 1.4565; 1.4529 EN 10088-1:2014 $f_{uk} \leq 1000 \text{ N/mm}^2$ $A_5 > 12 \%$ fracture elongation ¹⁾
3	Washer ISO 7089:2000	zinc plated $\geq 5 \mu\text{m}$, EN ISO 4042:1999 A2K or hot-dip galvanised EN ISO 10684:2004	1.4401; 1.4404; 1.4578; 1.4571; 1.4439; 1.4362 EN 10088-1:2014	1.4565; 1.4529 EN 10088-1:2014
4	Hexagon nut	Property class 5 or 8; EN ISO 898-2:2012 zinc plated $\geq 5 \mu\text{m}$, ISO 4042:1999 A2K or hot-dip galvanised EN ISO 10684:2004	Property class 50, 70 or 80 EN ISO 3506-1:2009 1.4401; 1.4404; 1.4578; 1.4571; 1.4439; 1.4362 EN 10088-1:2014	Property class 50, 70 or 80 EN ISO 3506-1:2009 1.4565; 1.4529 EN 10088-1:2014
5	fischer internal threaded anchor RG MI	Property class 5.8 ISO 898-1:2013 zinc plated $\geq 5 \mu\text{m}$, ISO 4042:1999 A2K	Property class 70 EN ISO 3506-1:2009 1.4401; 1.4404; 1.4578; 1.4571; 1.4439; 1.4362 EN 10088-1:2014	Property class 70 EN ISO 3506-1:2009 1.4565; 1.4529 EN 10088-1:2014
6	Screw or anchor / threaded rod for fischer internal threaded anchor RG MI	Property class 5.8 or 8.8; EN ISO 898-1:2013 zinc plated $\geq 5 \mu\text{m}$, ISO 4042:1999 A2K	Property class 70 EN ISO 3506-1:2009 1.4401; 1.4404; 1.4578; 1.4571; 1.4439; 1.4362 EN 10088-1:2014	Property class 70 EN ISO 3506-1:2009 1.4565; 1.4529 EN 10088-1:2014
7	Reinforcing bar EN 1992-1-1:2004 and AC:2010, Annex C	Bars and de-coiled rods, class B or C with f_{yk} and k according to NDP or NCL of EN 1992-1-1:2004+AC:2010 $f_{uk} = f_{tk} = k \cdot f_{yk}$		
8	fischer rebar anchor FRA	Rebar part: Bars and de-coiled rods class B or C with f_{yk} and k according to NDP or NCL of EN 1992-1-1:2004+AC:2010 $f_{uk} = f_{tk} = k \cdot f_{yk}$	Threaded part: Property class 70 or 80 EN ISO 3506-1:2009 1.4565; 1.4529, 1.4401, 1.4404, 1.4571, 1.4578, 1.4439, 1.4362, 1.4062 EN 10088-1:2014	
¹⁾ For applications without requirements for seismic performance category C2 the fracture elongation may be in the range of $A_5 > 8 \%$ in accordance with TR029 Section 5.2.3.2 (Reductions for seismic performance category C1 must be noted)				
fischer Superbond				Annex A 3
Product description Materials				

Specifications of intended use (part 1)

Table B1.1: Overview use and performance categories injection mortar system FIS SB

Anchorage subject to		FIS SB mit ...							
		Anchor rod 	fischer internal threaded anchor RG MI 	Reinforcing bar 	fischer rebar anchor FRA 				
Hammer drilling with standard drill bit 		all sizes							
Hammer drilling with hollow drill bit (Heller "Duster Expert" or Hilti "TE-CD, TE-YD") 		Nominal drill bit diameter (d_0) 12 mm to 35 mm							
Diamond drilling 		not permitted							
Static and quasi static load, in	uncracked concrete	all sizes	Tables: C1, C5, C6.1, C10	all sizes	Tables: C2, C5, C7.1, C11	all sizes	Tables: C3, C5, C8, C12	all sizes	Tables: C4, C5, C9, C13
	cracked concrete								
Seismic performance category (only hammer drilling with Standard / hollow drill bits)	C1	all sizes	Tables: C14, C16, C17	---	all sizes	---	Tables: C15, C16, C18	---	---
	C2		M12, M16, M20, M24				Tables: C14, C16, C19		
Use category	dry or wet concrete	all sizes							
	flooded hole	not permitted							
Installation temperature		FIS SB: -15 °C to +40 °C FIS SB High Speed: -20 °C to +40 °C							
In-service temperature	Temperature-range I	-40 °C to +40 °C	(max. long term temperature +24 °C and max. short term temperature +40 °C)						
	Temperature-range II	-40 °C to +80 °C	(max. long term temperature +50 °C and max. short term temperature +80 °C)						
	Temperature-range III	-40 °C to +120 °C	(max. long term temperature +72 °C and max. short term temperature +120 °C)						
	Temperature-range IV	-40 °C to +150 °C	(max. long term temperature +90 °C and max. short term temperature +150 °C)						







fischer Superbond

Intended Use
Specifications (part 1)

Annex B 1

Specifications of intended use (part 2)

Table B1.2: Overview use and performance categories resin capsule system RSB

Anchorages subject to		RSB with ...			
		fischer anchor rod RG M 	fischer internal threaded anchor RG MI 	Reinforcing bar 	fischer rebar anchor FRA 
Hammer drilling with standard drill bit 		all sizes	all sizes	not permitted	not permitted
Hammer drilling with hollow drill bit (Heller "Duster Expert" or Hilti "TE-CD, TE-YD") 		Nominal drill bit diameter (d_0) 12 mm to 35 mm	all sizes		
Diamond drilling 		all sizes ¹⁾	all sizes ¹⁾		
Static and quasi static load, in	uncracked concrete	all sizes	Tables: C1, C5, C6.2, C10		
	cracked concrete	all sizes ¹⁾		all sizes ¹⁾	
Seismic performance category (only hammer drilling with Standard / hollow drill bits)	C1	all sizes	Tables: C14, C16, C17	---	
	C2	---			
Use category	dry or wet concrete	all sizes	all sizes		
	flooded hole	all sizes	all sizes		
Installation temperature	-30 °C to +40 °C				
In-service temperature	Temperature-range I	-40 °C to +40 °C	(max. long term temperature +24 °C and max. short term temperature +40 °C)		
	Temperature-range II	-40 °C to +80 °C	(max. long term temperature +50 °C and max. short term temperature +80 °C)		
	Temperature-range III	-40 °C to +120 °C	(max. long term temperature +72 °C and max. short term temperature +120 °C)		
	Temperature-range IV	-40 °C to +150 °C	(max. long term temperature +90 °C and max. short term temperature +150 °C)		

¹⁾ For diamond drilling in cracked concrete only nominal drill bit diameters (d_0) \geq 18 mm are permitted

fischer Superbond

Intended Use
Specifications (part 2)

Annex B 2

Specifications of intended use (part 3)

Base materials:

- Reinforced or unreinforced normal weight concrete according to EN 206:2013
- Strength classes C20/25 to C50/60 according to EN 206:2013

Use conditions (Environmental conditions):

- Structures subject to dry internal conditions (zinc coated steel, stainless steel or high corrosion resistant steel)
- Structures subject to external atmospheric exposure (including industrial and marine environment) and to permanently damp internal condition, if no particular aggressive conditions exist (stainless steel or high corrosion resistant steel)
- Structures subject to external atmospheric exposure, to permanently damp internal conditions or in other particular aggressive conditions (high corrosion resistant steel)

Note: Particular aggressive conditions are e.g. permanent, alternating immersion in seawater or the splash zone of seawater, chloride atmosphere of indoor swimming pools or atmosphere with extreme chemical pollution (e.g. in desulphurization plants or road tunnels where de-icing materials are used)

Design:

- Anchorages have to be designed by a responsible engineer with experience of concrete anchor design
- Verifiable calculation notes and drawings are to be prepared taking account of the loads to be anchored. The position of the anchor is indicated on the design drawings (e.g. position of the anchor relative to reinforcement or to supports, etc.)
- Anchorages under static or quasi-static actions are designed in accordance with EOTA Technical Report TR 029 "Design of bonded anchors" Edition September 2010 or CEN/TS 1992-4:2009
- Anchorages under seismic actions (cracked concrete) have to be designed in accordance with:
 - EOTA Technical Report TR 045 "Design of Metal Anchors under Seismic Action", Edition February 2013
 - Anchorages shall be positioned outside of critical regions (e.g. plastic hinges) of the concrete structure
 - Fastenings in stand-off installation or with a grout layer are not allowed

Installation:

- Anchor installation is to be carried out by appropriately qualified personnel and under the supervision of the person responsible for technical matters of the site
- In case of aborted hole: The hole shall be filled with mortar
- Anchorage depth should be marked and adhered to on installation
- Overhead installation is allowed

fischer Superbond

Intended Use
Specifications (part 3)

Annex B 3

Table B2.1: Installation parameters for anchor rods in combination with injection mortar system FIS SB

Size		M8	M10	M12	M16	M20	M24	M27	M30
Width across flats	SW	13	17	19	24	30	36	41	46
Nominal drill bit diameter	d_0	10	12	14	18	24	28	30	35
Drill hole depth	h_0	$h_0 = h_{ef}$							
Effective anchorage depth	$h_{ef,min}$	60	60	70	80	90	96	108	120
	$h_{ef,max}$	160	200	240	320	400	480	540	600
Minimum spacing and minimum edge distance	s_{min} = c_{min}	40	45	55	65	85	105	120	140
Diameter of clearance hole in the fixture ¹⁾	pre-positioned anchorage d_f	9	12	14	18	22	26	30	33
	push through anchorage d_f	11	14	16	20	26	30	33	40
Minimum thickness of concrete member	h_{min}	$h_{ef} + 30$ (≥ 100)			$h_{ef} + 2d_0$				
Maximum installation torque	$T_{inst,max}$ [Nm]	10	20	40	60	120	150	200	300

¹⁾ For larger clearance holes in the fixture see TR 029, 4.2.2.1 or CEN/TS 1992-4-1:2009, 5.2.3.1

Anchor rod:

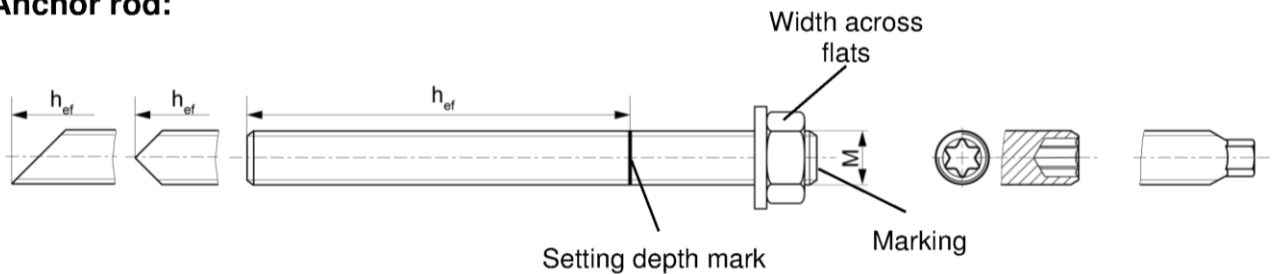

Marking (on random place) fischer anchor rod:

- Property class 8.8, stainless steel, property class 80 or high corrosion resistant steel, property class 80: •
- Stainless steel A4, property class 50 and high corrosion resistant steel, property class 50: ••
- Or colour coding according to DIN 976-1

Commercial standard threaded rods, washers and hexagon nuts may also be used if the following requirements are fulfilled:

- Materials, dimensions and mechanical properties according Annex A 3, Table A1
- Inspection certificate 3.1 according to EN 10204:2004, the documents have to be stored
- Setting depth is marked

fischer Superbond

Intended Use

Installation parameters anchor rods in combination with injection mortar system FIS SB

Annex B 4

Table B2.2: Installation parameters for fischer anchor rods RG M in combination with resin capsule system RSB

Size		M8	M10	M12	M16	M20	M24	M30
Width across flats	SW	13	17	19	24	30	36	46
Nominal drill bit diameter	d_0	10	12	14	18	25	28	35
Drill hole depth	h_0	$h_0 = h_{ef}$						
Effective anchorage depth	$h_{ef,1}$	---	75	75	95	---	---	---
	$h_{ef,2}$	80	90	110	125	170	210	280
	$h_{ef,3}$	---	150	150	190	210	---	---
Width across flats	s_{min} = c_{min}	40	45	55	65	85	105	140
Diameter of pre-clearance hole in the fixture ¹⁾	pre-positioned anchorage d_f	9	12	14	18	22	26	33
Minimum thickness of concrete member	h_{min}	$h_{ef} + 30$ (≥ 100)			$h_{ef} + 2d_0$			
Maximum installation torque	$T_{inst,max}$ [Nm]	10	20	40	60	120	150	300

¹⁾ For larger clearance holes in the fixture see TR 029, 4.2.2.1 or CEN/TS 1992-4-1:2009, 5.2.3.1

Anchor rod RG M:

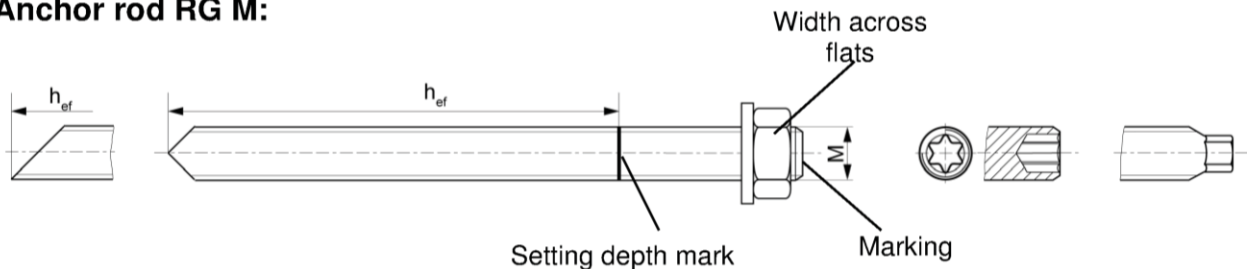

Marking (on random place):

Property class 8.8, stainless steel, property class 80 or high corrosion resistant steel, property class 80: ●
 Stainless steel A4, property class 50 and high corrosion resistant steel, property class 50: ●●
 Or colour coding according to DIN 976-1

fischer Superbond

Intended Use

Installation parameters anchor rods in combination with resin capsule system RSB

Annex B 5

Table B3: Installation parameters for fischer internal threaded anchors RG MI

Size		M8	M10	M12	M16	M20
Diameter of anchor	d_H	12	16	18	22	28
Nominal drill bit diameter	d_0	14	18	20	24	32
Drill hole depth	h_0	$h_0 = h_{ef}$				
Effective anchorage depth ($h_{ef} = L_H$)	h_{ef}	90	90	125	160	200
Minimum spacing and minimum edge distance	s_{min} = c_{min}	55	65	75	95	125
Diameter of clearance hole in the fixture ¹⁾	d_f	9	12	14	18	22
Minimum thickness of concrete member	h_{min}	120	125	165	205	260
Maximum screw-in depth	$l_{E,max}$	18	23	26	35	45
Minimum screw-in depth	$l_{E,min}$	8	10	12	16	20
Maximum installation torque	$T_{inst,max}$ [Nm]	10	20	40	80	120

¹⁾ For larger clearance holes in the fixture see TR 029, 4.2.2.1 or CEN/TS 1992-4-1:2009, 5.2.3.1

fischer internal threaded anchor RG MI

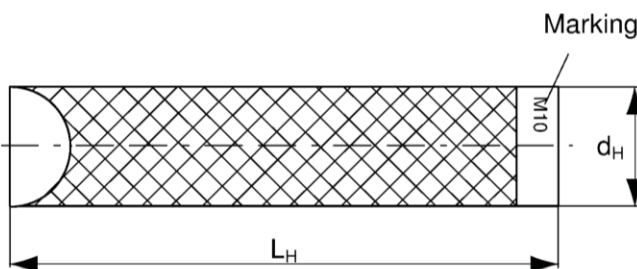
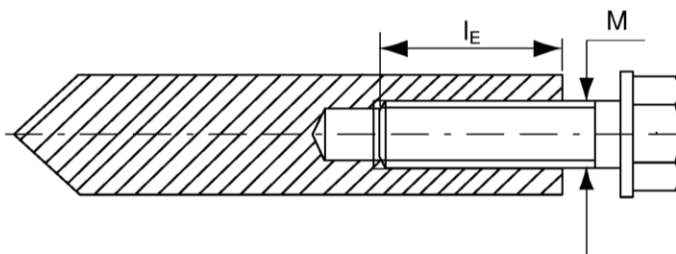

Marking: Anchor size
e.g.: **M10**

Stainless steel additional **A4**
e.g.: **M10 A4**

High corrosion resistant steel
additional **C**
e.g.: **M10 C**

Retaining bolt or threaded rods (including nut and washer) must comply with the appropriate material and strength class of Annex A 3, Table A1

fischer Superbond

Intended Use
Installation parameters fischer internal threaded anchors RG MI

Annex B 6

Table B4: Installation parameters for reinforcing bars

Nominal diameter of the bar		ϕ	8 ¹⁾		10 ¹⁾		12 ¹⁾		14	16	20	25	28	32	
Nominal drill bit diameter	d_0	[mm]	10	12	12	14	14	16	18	20	25	30	35	40	
Drill hole depth	h_0		$h_0 = h_{ef}$												
Effective anchorage depth	$h_{ef,min}$		60	60	70	75	80	90	100	112	128				
	$h_{ef,max}$		160	200	240	280	320	400	500	560	640				
Minimum spacing and minimum edge distance	s_{min}		40	45	55	60	65	85	110	130	160				
	c_{min}														
Minimum thickness of concrete member	h_{min}	$h_{ef} + 30$ (≥ 100)				$h_{ef} + 2d_0$									

¹⁾ Both drill bit diameters can be used

Reinforcing bar

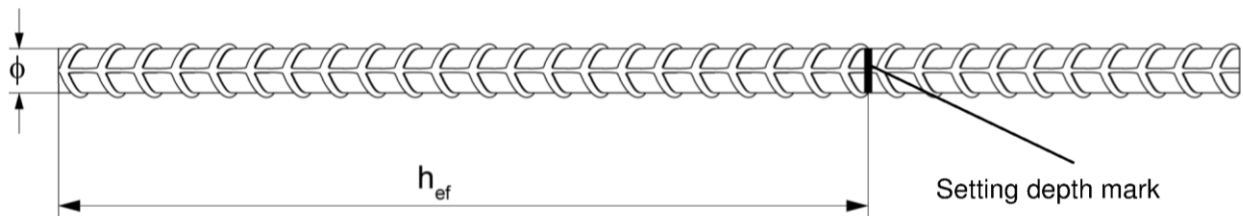

- The minimum value of related rib area $f_{R,min}$ must fulfil the requirements of EN 1992-1-1:2004+AC:2010
- The rib height must be within the range: $0,05 \cdot \phi \leq h_{rib} \leq 0,07 \cdot \phi$
(ϕ = Nominal diameter of the bar , h_{rib} = rib height)

fischer Superbond

Intended Use
Installation parameters reinforcing bars

Annex B 7

Table B5: Installation parameters for fischer rebar anchor FRA

Size		M12 ¹⁾	M16	M20	M24
Nominal diameter of the bar	ϕ	12	16	20	25
Width across flats	SW	19	24	30	36
Nominal drill bit diameter	d_0	14	16	20	30
Drill hole depth	h_0	$h_{ef} + l_e$			
Effective anchorage depth	$h_{ef,min}$	70	80	90	96
	$h_{ef,max}$	140	220	300	380
Distance concrete surface to welded joint	l_e	100			
Minimum spacing and minimum edge distance	s_{min}	55	65	85	105
	c_{min}				
Diameter of clearance hole in the fixture ²⁾	pre-positioned anchorage $\leq d_f$	14	18	22	26
	push through anchorage $\leq d_f$	18	22	26	32
Minimum thickness of concrete member	h_{min}	$h_0 + 30$ (≥ 100)	$h_0 + 2d_0$		
Maximum installation torque	$T_{inst,max}$ [Nm]	40	60	120	150

¹⁾ Both drill bit diameters can be used

²⁾ For larger clearance holes in the fixture see TR 029, 4.2.2.1 or CEN/TS 1992-4-1:2009, 5.2.3.1

fischer rebar anchor FRA

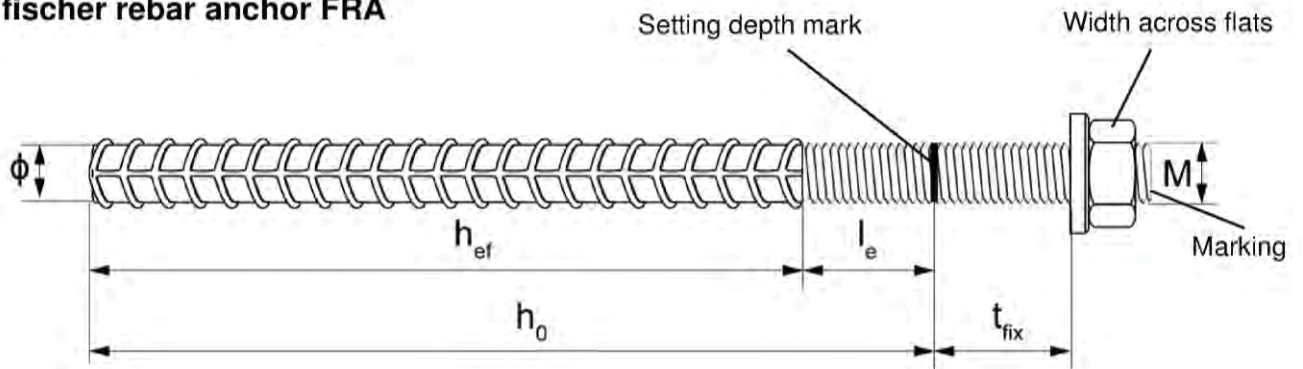

Marking frontal e.g.:

- FRA (for stainless steel);
- FRA C (for high corrosion resistant steel)

fischer Superbond

Intended Use
Installation parameters rebar anchor FRA

Annex B 8

Table B6: Dimension of resin capsule RSB

Resin capsule		RSB 8	RSB 10 mini	RSB 10	RSB 12 mini	RSB 12	RSB 16 mini	RSB 16	RSB 16 E	RSB 20	RSB 20 E / 24	RSB 30
Diameter of the capsule	d_p	9,0	10,5		12,5		16,5			23,0		27,5
Length of the capsule	L_p	85	72	90	72	97	72	95	123	160	190	260

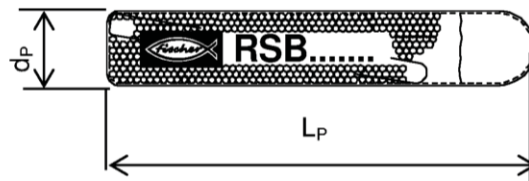
**Table B7:** Allocation of resin capsule RSB to fischer anchor rod RG M

Size		M8	M10	M12	M16	M20	M24	M30
Minimum anchorage depth	$h_{ef,1}$ [mm]	---	75	75	95	---	---	---
Associated resin capsule RSB	[-]	---	10 mini	12 mini	16 mini	---	---	---
Medium anchorage depth	$h_{ef,2}$ [mm]	80	90	110	125	170	210	280
Associated resin capsule RSB	[-]	8	10	12	16	20	20 E/ 24	30
Maximum anchorage depth	$h_{ef,3}$ [mm]	---	150	150	190	210	---	---
Associated resin capsule RSB	[-]	---	2 x 10 mini	2 x 12 mini	2 x 16 mini	20 E / 24	---	---

Table B8: Allocation of resin capsule RSB to fischer internal threaded anchor RG MI

Size		M8	M10	M12	M16	M20
Effective anchorage depth	h_{ef} [mm]	90	90	125	160	200
Associated resin capsule RSB	[-]	10	12	16	16E	20 E/ 24

fischer Superbond

Intended Use
Resin capsule RSB
Parameters and allocations

Annex B 9

Table B9: Parameters of steel brush FIS BS Ø

Drill bit diameter	d_0	[mm]	10	12	14	16	18	20	24	25	28	30	32	35	40
Steel brush diameter	d_b		11	14	16	20		25	26	27	30	40		42	



Table B10: Maximum processing time of the mortar and minimum curing time
(Minimal cartridge temperature +5 °C; minimal resin capsule temperature -15 °C)

System temperature [°C]	Maximum processing time t_{work} [minutes]		Minimum curing time ¹⁾ t_{cure} [minutes]		
	FIS SB	FIS SB High Speed	FIS SB	FIS SB High Speed	RSB
	-30 bis -20	---	---	---	---
> -20 bis -15	---	60	---	24 hours	48 hours
> -15 bis -10	60	30	36 hours	8 hours	30 hours
> -10 bis -5	30	15	24 hours	3 hours	16 hours
> -5 bis ±0	20	10	8 hours	2 hours	10 hours
> ±0 bis +5	13	5	4 hours	1 hour	45
> +5 bis +10	9	3	2 hours	45	30
> +10 bis +20	5	2	1 hour	30	20
> +20 bis +30	4	1	45	15	5
> +30 bis +40	2	---	30	---	3





fischer Superbond

Intended Use
Cleaning tools
Processing times and curing times

Annex B 10

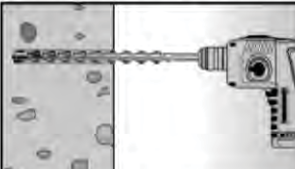
Installation instructions part 1; Injection mortar system FIS SB

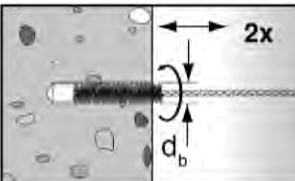
Drilling and cleaning the hole (hammer drilling with standard drill bit)

1		<p>Drill the hole. Drill hole diameter d_0 and drill hole depth h_0 see Tables B2.1, B3, B4, B5</p>	
2		<p>Blow out the drill hole twice, with oil-free compressed air ($p \geq 6$ bar). In uncracked concrete the use of a manual blow-out pump is possible (Installation parameters: $d_0 < 18$ mm and $h_{ef} < 10d$)</p>	
3		<p>Brush the drill hole twice. For drill hole diameter ≥ 30 mm use a power drill. For deep holes use an extension. Corresponding brushes see Table B9</p>	
4		<p>Blow out the drill hole twice, with oil-free compressed air ($p \geq 6$ bar). In uncracked concrete the use of a manual blow-out pump is possible (Installation parameters: $d_0 < 18$ mm and $h_{ef} < 10d$)</p>	

Go to step 5

Drilling and cleaning the hole (hammer drilling with hollow drill bit)

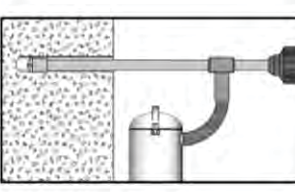
1		<p>Check a suitable hollow drill (see Table B1.1) for correct operation of the dust extraction</p>	
2		<p>Use a suitable dust extraction system, e.g. Bosch GAS 35 M AFC or a comparable dust extraction system with equivalent performance data</p> <p>Drill the hole with hollow drill bit. The dust extraction system has to extract the drill dust nonstop during the drilling process. Diameter of drill hole d_0 and drill hole depth h_0 see Tables B2.1, B3, B4, B5</p>	

Go to step 5



fischer Superbond

Intended use
Installation instructions part 1

Annex B 11

Installation instructions part 2; Injection mortar system FIS SB

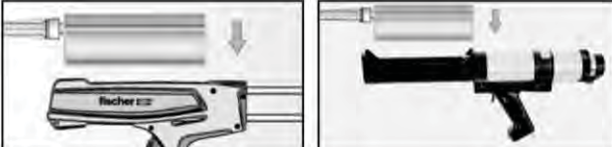
Preparing the cartridge

5		<p>Remove the sealing cap</p> <p>Screw on the static mixer (the spiral in the static mixer must be clearly visible)</p>
6		<p>Place the cartridge into the dispenser</p>
7		<p>Extrude approximately 10 cm of material until the resin is evenly grey in colour. Do not use mortar that is not uniformly grey</p>

Mortar injection

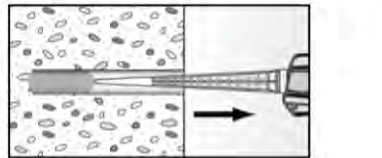
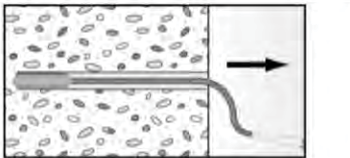
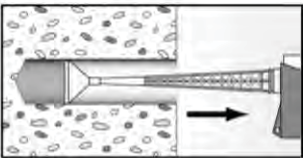
8	 <p>Fill approximately 2/3 of the drill hole with mortar. Always begin from the bottom of the hole and avoid bubbles</p>	 <p>For drill hole depth ≥ 150 mm use an extension tube</p>	 <p>For overhead installation, deep holes $h_0 > 250$ mm or drill hole diameter $d_0 \geq 40$ mm use an injection-adapter</p>
---	--	--	--

Go to step 9





fischer Superbond

Intended use
Installation instructions part 2

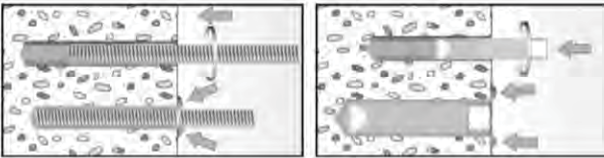

Annex B 12

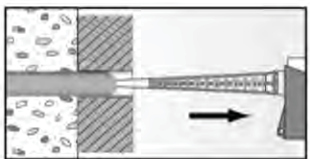
Installation instructions part 3; Injection mortar system FIS SB

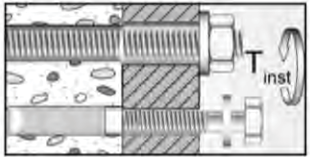
Installation anchor rod or fischer internal threaded anchor RG MI

9		<p>Only use clean and oil-free anchor elements. Mark the setting depth of the anchor. Push the threaded rod or fischer internal threaded RG MI anchor down to the bottom of the hole, turning it slightly while doing so. After inserting the anchor element, excess mortar must be emerged around the anchor element. If not, pull out the anchor element immediately and reinject mortar</p>
	 <p>For overhead installations support the anchor rod with wedges. (e.g. fischer centering wedges)</p>	 <p>For push through installation fill the annular gap with mortar</p>
10	 <p>Wait for the specified curing time t_{cure} see Table B10</p>	<p>11</p>  <p>Mounting the fixture $T_{inst,max}$ see Tables B2.1, B3</p>

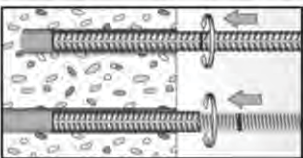
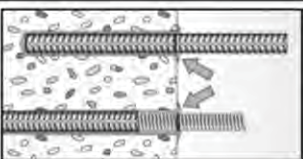

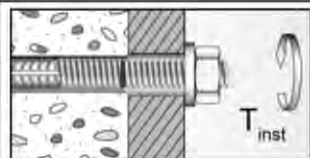
Installation reinforcing bar or fischer FRA

9		<p>Only use clean and oil-free reinforcing bars or fischer FRA. Mark the setting depth. Turn while using force to push the reinforcement bar or the fischer FRA into the filled hole up to the setting depth mark</p>
	 <p>When the setting depth mark is reached, excess mortar must be emerged from the mouth of the drill hole. If not, pull out the anchor element immediately and reinject mortar</p>	
10	 <p>Wait for the specified curing time t_{cure} see Table B10</p>	<p>11</p>  <p>Mounting the fixture $T_{inst,max}$ see Table B5</p>

fischer Superbond	Annex B 13
<p>Intended use Installation instructions part 3</p>	

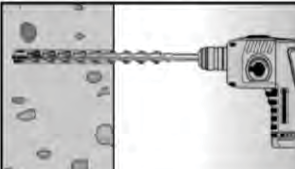
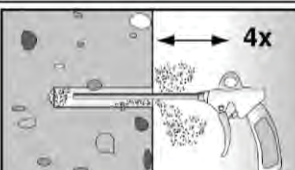

Installation instructions part 4; resin capsule RSB

Drilling and cleaning the hole (hammer drilling with standard drill bit)

1		<p>Drill the hole. Drill hole diameter d_0 and drill hole depth h_0 see Tables B2.2, B3</p>	
2		<p>Blow out the drill hole four times, with oil-free compressed air ($p \geq 6$ bar). In uncracked concrete the use of a manual blow-out pump is possible (Installation parameters: $d_0 < 18$ mm and $h_{ef} < 10d$)</p>	

Go to step 6

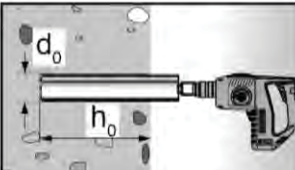
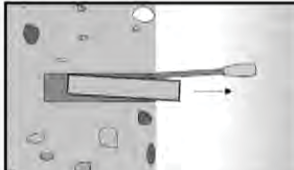
Drilling and cleaning the hole (wet drilling with diamond drill bit)

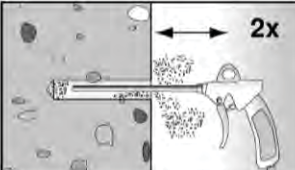
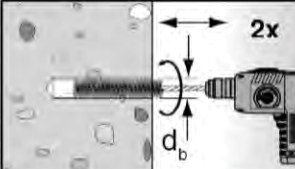
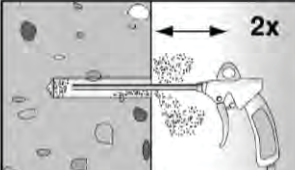
1		<p>Drill the hole. Drill hole diameter d_0 and drill hole depth h_0 see Tables B2.2, B3</p>		<p>Break the drill core and draw it out</p>
2		<p>Flush the drill hole with clean water until it flows clear</p>		
3		<p>Blow out the drill hole twice, using oil-free compressed air ($p > 6$ bar)</p>		
4		<p>Brush the drill hole twice using a power drill. Corresponding brushes see Table B9</p>		
5		<p>Blow out the drill hole twice, using oil-free compressed air ($p > 6$ bar)</p>		

Go to step 6

fischer Superbond

Intended use
Installation instructions part 4

Annex B 14



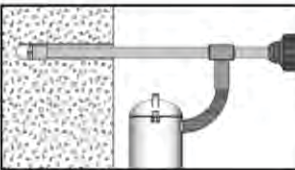

Installation instructions part 5; resin capsule RSB

Drilling and cleaning the hole (hammer drilling with hollow drill bit)

1		<p>Check a suitable hollow drill (see Table B1.2) for correct operation of the dust extraction</p>
2		<p>Use a suitable dust extraction system, e.g. Bosch GAS 35 M AFC or a comparable dust extraction system with equivalent performance data</p> <p>Drill the hole with hollow drill bit. The dust extraction system has to extract the drill dust nonstop during the drilling process. Diameter of drill hole d_0 and drill hole depth h_0 see Tables B2.2, B3</p>

Go to step 6

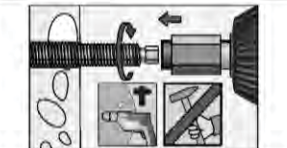
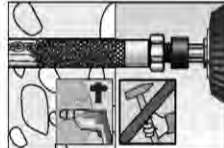
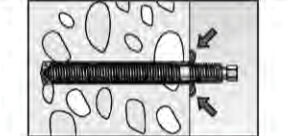
Installation fischer anchor rod RG M or fischer internal threaded anchor RG MI

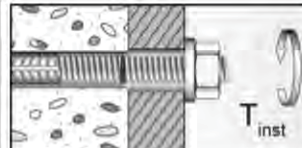
6		<p>Resin capsule RSB or two RSB mini, must be pushed into the drill hole by hand</p>		<p>Depending on the anchor being installed, use a suitable setting tool</p>	
7			<p>Only use clean and grease-free anchors. Using a suitable adapter, drive the RG M or fischer internal threaded anchor RG MI into the capsule using a hammer drill set on rotary hammer action. Stop when the anchor reaches the bottom of the hole and is set to the correct embedment depth</p>		
8		<p>When reaching the correct embedment depth, excess mortar must emerge from the mouth of the drill hole. If not, the anchor must be pulled out directly and a second resin capsule must be pushed into the drill hole. Setting process must be repeated (7)</p>			
9		<p>Wait for the specified curing time, t_{cure} see Table B10</p>	10		<p>Mounting the fixture max T_{inst} see Tables B2.2, B3</p>

fischer Superbond

Intended use
Installation instructions part 5

Annex B 15

Table C1: Characteristic values for the steel bearing capacity under tensile / shear load of fischer anchor rods and standard threaded rods

Size		M8	M10	M12	M16	M20	M24	M27	M30			
Bearing capacity under tensile load, steel failure												
Charact. bearing capacity $N_{Rk,s}$	Steel zinc plated	5.8	Property class	[kN]	19	29	43	79	123	177	230	281
		8.8			29	47	68	126	196	282	368	449
	Stainless steel A4 and High corrosion resistant steel C	50			19	29	43	79	123	177	230	281
		70			26	41	59	110	172	247	322	393
		80			30	47	68	126	196	282	368	449
Partial safety factors¹⁾												
Partial safety factor $\gamma_{Ms,N}$	Steel zinc plated	5.8	Property class	[-]	1,50							
		8.8			1,50							
	Stainless steel A4 and High corrosion resistant steel C	50			2,86							
		70			1,50 ²⁾ / 1,87							
		80			1,60							
Bearing capacity under shear load, steel failure												
without lever arm												
Charact. bearing capacity $V_{Rk,s}$	Steel zinc plated	5.8	Property class	[kN]	9	15	21	39	61	89	115	141
		8.8			15	23	34	63	98	141	184	225
	Stainless steel A4 and High corrosion resistant steel C	50			9	15	21	39	61	89	115	141
		70			13	20	30	55	86	124	161	197
		80			15	23	34	63	98	141	184	225
with lever arm												
Charact. bending moment $M_{Rk,s}^0$	Steel zinc plated	5.8	Property class	[Nm]	19	37	65	166	324	560	833	1123
		8.8			30	60	105	266	519	896	1333	1797
	Stainless steel A4 and High corrosion resistant steel C	50			19	37	65	166	324	560	833	1123
		70			26	52	92	232	454	784	1167	1573
		80			30	60	105	266	519	896	1333	1797
Partial safety factors¹⁾												
Partial safety factor $\gamma_{Ms,V}$	Steel zinc plated	5.8	Property class	[-]	1,25							
		8.8			1,25							
	Stainless steel A4 and High corrosion resistant steel C	50			2,38							
		70			1,25 ²⁾ / 1,56							
		80			1,33							

¹⁾ In absence of other national regulations

²⁾ Only admissible for steel C, with $f_{yk} / f_{uk} \geq 0,8$ and $A_5 > 12\%$ (e.g. fischer anchor rods)

fischer Superbond

Performances

Characteristic steel bearing capacity of fischer anchor rods and standard threaded rods

Annex C 1

Table C2: Characteristic values for the steel bearing capacity under tensile / shear load of fischer internal threaded anchors RG MI

Size			M8	M10	M12	M16	M20	
Bearing capacity under tensile load, steel failure								
Characteristic bearing capacity with screw	Property class	5.8	[kN]	19	29	43	79	123
		8.8		29	47	68	108	179
	Property class 70	A4		26	41	59	110	172
		C		26	41	59	110	172
Partial safety factors¹⁾								
Partial safety factor	Property class	5.8	[-]	1,50				
		8.8		1,50				
	Property class 70	A4		1,87				
		C		1,87				
Bearing capacity under shear load, steel failure								
without lever arm								
Characteristic bearing capacity with screw	Property class	5.8	[kN]	9,2	14,5	21,1	39,2	62,0
		8.8		14,6	23,2	33,7	54,0	90,0
	Property class 70	A4		12,8	20,3	29,5	54,8	86,0
		C		12,8	20,3	29,5	54,8	86,0
with lever arm								
Characteristic bending moment with screw	Property class	5.8	[Nm]	20	39	68	173	337
		8.8		30	60	105	266	519
	Property class 70	A4		26	52	92	232	454
		C		26	52	92	232	454
Partial safety factors¹⁾								
Partial safety factor	Property class	5.8	[-]	1,25				
		8.8		1,25				1,25 / 1,50 ²⁾
	Property class 70	A4		1,56				
		C		1,56				

¹⁾ In absence of other national regulations

²⁾ Only for steel failure without lever arm

fischer Superbond

Performances

Characteristic steel bearing capacity of fischer internal threaded anchors RG MI

Annex C 2

Table C3: Characteristic values for the steel bearing capacity under tensile / shear load of reinforcing bars

Nominal diameter of the bar	ϕ	8	10	12	14	16	20	25	28	32
Bearing capacity under tensile load, steel failure										
Characteristic bearing capacity	$N_{Rk,s}$	[kN]	$A_s \cdot f_{uk}^{1)}$							
Bearing capacity under shear load, steel failure										
without lever arm										
Characteristic bearing capacity	$V_{Rk,s}$	[kN]	$0,5 \cdot A_s \cdot f_{uk}^{1)}$							
Ductility factor acc. to CEN/TS 1992-4-5:2009 Section 6.3.2.1	k_2	[-]	0,8							
with lever arm										
Characteristic bending moment	$M_{Rk,s}^0$	[Nm]	$1,2 \cdot W_{el} \cdot f_{uk}^{1)}$							

¹⁾ f_{uk} or f_{yk} respectively must be taken from the specifications of the reinforcing bar

Table C4: Characteristic values for the steel bearing capacity under tensile / shear load of fischer rebar anchors FRA

Size	M12	M16	M20	M24		
Bearing capacity under tensile load, steel failure						
Characteristic bearing capacity	$N_{Rk,s}$	[kN]	63	111	173	270
Partial safety factors¹⁾						
Partial safety factor	$\gamma_{Ms,N}$	[-]	1,4			
Bearing capacity under shear load, steel failure						
without lever arm						
Characteristic bearing capacity	$V_{Rk,s}$	[kN]	30	55	86	124
with lever arm						
Characteristic bearing capacity	$M_{Rk,s}^0$	[Nm]	92	233	454	785
Partial safety factors¹⁾						
Partial safety factor	$\gamma_{Ms,V}$	[-]	1,56			

¹⁾ In absence of other national regulations

fischer Superbond

Performances

Characteristic steel bearing capacity of reinforcing bars and fischer rebar anchors FRA

Annex C 3

Table C5: General design factors for the bearing capacity under tensile / shear load; uncracked or cracked concrete

Size		All Sizes									
Bearing capacity under tensile load											
Factors acc. to CEN/TS 1992-4:2009 Section 6.2.2.3											
Uncracked concrete	k_{ucr}	[-]	10,1								
Cracked concrete	k_{cr}		7,2								
Factors for the compressive strength of concrete > C20/25											
Increasing factor for τ_{Rk}	C25/30	Ψ_c	[-]	1,02							
	C30/37			1,04							
	C35/45			1,07							
	C40/50			1,08							
	C45/55			1,09							
	C50/60			1,10							
Splitting failure											
Edge distance	$h / h_{ef} \geq 2,0$	$C_{cr,sp}$	[mm]	1,0 h_{ef}							
	$2,0 > h / h_{ef} > 1,3$			4,6 $h_{ef} - 1,8 h$							
	$h / h_{ef} \leq 1,3$			2,26 h_{ef}							
Spacing	$S_{cr,sp}$			2 $C_{cr,sp}$							
Bearing capacity under shear load											
Installation safety factors											
All installation conditions	$\gamma_2 = \gamma_{inst}$	[-]	1,0								
Concrete pry-out failure											
Factor k acc. to TR029 Section 5.2.3.3 resp. k_3 acc. to CEN/TS 1992-4-5:2009 Section 6.3.3	$k_{(3)}$	[-]	2,0								
Concrete edge failure											
The value of h_{ef} (= l_f) under shear load		[mm]	min (h_{ef} ; 8d)								
Calculation diameters											
Size			M8	M10	M12	M16	M20	M24	M27	M30	
fischer anchor rods and standard threaded rods	d	[mm]	8	10	12	16	20	24	27	30	
fischer internal threaded anchors RG MI	d		12	16	18	22	28	---	---	---	
fischer rebar anchors FRA	d		---	---	12	16	20	25	---	---	
Nominal diameter of the bar	ϕ		8	10	12	14	16	20	25	28	32
Reinforcing bar	d	[mm]	8	10	12	14	16	20	25	28	32
fischer Superbond										Annex C 4	
Performances General design factors relating to the characteristic bearing capacity under tensile / shear load											

Table C6.1: Characteristic values of resistance for fischer anchor rods and standard threaded rods in hammer drilled holes in combination with injection mortar system FIS SB; uncracked or cracked concrete

Size	M8	M10	M12	M16	M20	M24	M27	M30		
Combined pullout and concrete cone failure										
Calculation diameter d [mm]	8	10	12	16	20	24	27	30		
Uncracked concrete										
Characteristic bond resistance in uncracked concrete C20/25										
Hammer-drilling with standard drill bit or hollow drill bit (dry and wet concrete)										
Temperature range	I: 24 °C / 40 °C	$\tau_{Rk,ucr}$ [N/mm ²]	12	13	13	13	13	12	10	10
	II: 50 °C / 80 °C		12	12	12	13	13	12	10	10
	III: 72 °C / 120 °C		10	11	11	11	11	11	9	9
	IV: 90 °C / 150 °C		10	10	10	11	10	10	8	8
Installation safety factors										
Dry and wet concrete	$\gamma_2 = \gamma_{inst}$	[-]	1,0							
Cracked concrete										
Characteristic bond resistance in cracked concrete C20/25										
Hammer-drilling with standard drill bit or hollow drill bit (dry and wet concrete)										
Temperature range	I: 24 °C / 40 °C	$\tau_{Rk,cr}$ [N/mm ²]	6,5	7,0	7,5	7,5	7,5	7,5	7,5	7,5
	II: 50 °C / 80 °C		6,0	6,5	7,5	7,5	7,5	7,5	7,0	7,0
	III: 72 °C / 120 °C		5,5	6,0	6,5	6,5	6,5	6,5	6,0	6,0
	IV: 90 °C / 150 °C		5,0	5,5	6,0	6,0	6,0	6,0	5,5	5,5
Installation safety factors										
Dry and wet concrete	$\gamma_2 = \gamma_{inst}$	[-]	1,0							

fischer Superbond

Performances

Characteristic values for static or quasi-static action under tensile load for fischer anchor rods and standard threaded rods with FIS SB (uncracked or cracked concrete)

Annex C 5

Table C6.2: Characteristic values of **resistance** for **fischer anchor rods RG M** in hammer or diamond drilled holes in combination with **resin capsule RSB**; **uncracked or cracked concrete**

Size	M8	M10	M12	M16	M20	M24	M30		
Combined pullout and concrete cone failure									
Calculation diameter d [mm]	8	10	12	16	20	24	30		
Uncracked concrete									
Characteristic bond resistance in uncracked concrete C20/25									
Hammer-drilling with standard drill bit or hollow drill bit (dry and wet concrete as well as flooded hole)									
Temperature range	I: 24 °C / 40 °C	$\tau_{Rk,ucr}$ [N/mm ²]	12	13	13	13	13	12	10
	II: 50 °C / 80 °C		12	12	12	13	13	12	10
	III: 72 °C / 120 °C		10	11	11	11	11	11	9
	IV: 90 °C / 150 °C		10	10	10	11	10	10	8
Diamond-drilling (dry and wet concrete as well as flooded hole)									
Temperature range	I: 24 °C / 40 °C	$\tau_{Rk,ucr}$ [N/mm ²]	13	13	14	14	14	13	11
	II: 50 °C / 80 °C		12	13	13	14	13	13	10
	III: 72 °C / 120 °C		11	12	12	12	12	11	9,5
	IV: 90 °C / 150 °C		10	11	11	11	11	10	8,5
Installation safety factors									
Dry and wet concrete	$\gamma_2 = \gamma_{inst}$	[-]	1,0						
Flooded hole	$\gamma_2 = \gamma_{inst}$	[-]	1,2		1,0				
Cracked concrete									
Characteristic bond resistance in cracked concrete C20/25									
Hammer-drilling with standard drill bit or hollow drill bit (dry and wet concrete as well as flooded hole)									
Temperature range	I: 24 °C / 40 °C	$\tau_{Rk,cr}$ [N/mm ²]	6,5	7,0	7,5	7,5	7,5	7,5	7,5
	II: 50 °C / 80 °C		6,0	6,5	7,5	7,5	7,5	7,5	7,0
	III: 72 °C / 120 °C		5,5	6,0	6,5	6,5	6,5	6,5	6,0
	IV: 90 °C / 150 °C		5,0	5,5	6,0	6,0	6,0	6,0	5,5
Diamond-drilling (dry and wet concrete as well as flooded hole)									
Temperature range	I: 24 °C / 40 °C	$\tau_{Rk,cr}$ [N/mm ²]	---	---	---	7,5	7,5	7,5	7,5
	II: 50 °C / 80 °C		---	---	---	7,5	7,5	7,5	7,0
	III: 72 °C / 120 °C		---	---	---	6,5	6,5	6,5	6,5
	IV: 90 °C / 150 °C		---	---	---	6,0	6,0	6,0	6,0
Installation safety factors									
Dry and wet concrete	$\gamma_2 = \gamma_{inst}$	[-]	1,0						
Flooded hole	$\gamma_2 = \gamma_{inst}$	[-]	1,2		1,0				
fischer Superbond							Annex C 6		
Performances Characteristic values for static or quasi-static action under tensile load for fischer anchor rods RG M with RSB (uncracked or cracked concrete)									

Table C7.1: Characteristic values of resistance for fischer internal threaded anchors RG MI in hammer drilled holes in combination with injection mortar FIS SB; uncracked or cracked concrete

Size	M8	M10	M12	M16	M20		
Combined pullout and concrete cone failure							
Calculation diameter d [mm]	12	16	18	22	28		
Uncracked concrete							
Characteristic bond resistance in uncracked concrete C20/25							
Hammer-drilling with standard drill bit or hollow drill bit (dry and wet concrete)							
Temperature range	I: 24 °C / 40 °C	$\tau_{Rk,ucr}$ [N/mm ²]	12	12	11	11	9,5
	II: 50 °C / 80 °C		12	11	11	10	9
	III: 72 °C / 120 °C		11	10	10	9	8
	IV: 90 °C / 150 °C		10	9,5	9	8,5	7,5
Installation safety factors							
Dry and wet concrete	$\gamma_2 = \gamma_{inst}$	[-]	1,0				
Cracked concrete							
Characteristic bond resistance in cracked concrete C20/25							
Hammer-drilling with standard drill bit or hollow drill bit (dry and wet concrete)							
Temperature range	I: 24 °C / 40 °C	$\tau_{Rk,cr}$ [N/mm ²]	5				
	II: 50 °C / 80 °C		5				
	III: 72 °C / 120 °C		4,5				
	IV: 90 °C / 150 °C		4				
Installation safety factors							
Dry and wet concrete	$\gamma_2 = \gamma_{inst}$	[-]	1,0				

fischer Superbond

Performances

Characteristic values for static or quasi-static action under tensile load for fischer internal threaded anchors RG MI (uncracked or cracked concrete)

Annex C 7

Table C7.2: Characteristic values of resistance for fischer internal threaded anchors RG MI in hammer or diamond drilled holes in combination with resin capsule RSB; uncracked or cracked concrete

Size		M8	M10	M12	M16	M20	
Combined pullout and concrete cone failure							
Calculation diameter	d [mm]	12	16	18	22	28	
Uncracked concrete							
Characteristic bond resistance in uncracked concrete C20/25							
Hammer-drilling with standard drill bit or hollow drill bit (dry and wet concrete as well as flooded hole)							
Temperature range	I: 24 °C / 40 °C	$\tau_{Rk,ucr}$ [N/mm ²]	12	12	11	11	9,5
	II: 50 °C / 80 °C		12	11	11	10	9
	III: 72 °C / 120 °C		11	10	10	9	8
	IV: 90 °C / 150 °C		10	9,5	9	8,5	7,5
Diamond-drilling (dry and wet concrete as well as flooded hole)							
Temperature range	I: 24 °C / 40 °C	$\tau_{Rk,ucr}$ [N/mm ²]	13	12	12	11	10
	II: 50 °C / 80 °C		13	12	12	11	9,5
	III: 72 °C / 120 °C		11	11	10	9,5	8,5
	IV: 90 °C / 150 °C		10	10	9,5	9	8
Installation safety factors							
Dry and wet concrete	$\gamma_2 = \gamma_{inst}$	[-]	1,0				
Flooded hole	$\gamma_2 = \gamma_{inst}$	[-]	1,2	1,0			
Cracked concrete							
Characteristic bond resistance in cracked concrete C20/25							
Hammer-drilling with standard drill bit or hollow drill bit (dry and wet concrete as well as flooded hole)							
Temperature range	I: 24 °C / 40 °C	$\tau_{Rk,cr}$ [N/mm ²]	5				
	II: 50 °C / 80 °C		5				
	III: 72 °C / 120 °C		4,5				
	IV: 90 °C / 150 °C		4				
Diamond-drilling (dry and wet concrete as well as flooded hole)							
Temperature range	I: 24 °C / 40 °C	$\tau_{Rk,cr}$ [N/mm ²]	---	5			
	II: 50 °C / 80 °C		---	5			
	III: 72 °C / 120 °C		---	4,5			
	IV: 90 °C / 150 °C		---	4			
Installation safety factors							
Dry and wet concrete	$\gamma_2 = \gamma_{inst}$	[-]	1,0				
Flooded hole	$\gamma_2 = \gamma_{inst}$	[-]	1,2	1,0			

fischer Superbond

Performances

Characteristic values for static or quasi-static action under tensile load for fischer internal threaded anchors RG MI with RSB (uncracked or cracked concrete)

Annex C 8

Table C8: Characteristic values of **resistance** for **reinforcing bars** in hammer drilled holes in combination with **injection mortar FIS SB; uncracked or cracked concrete**

Nominal diameter of the bar		ϕ	8	10	12	14	16	20	25	28	32		
Combined pullout and concrete cone failure													
Calculation diameter		d	[mm]	8	10	12	14	16	20	25	28	32	
Uncracked concrete													
Characteristic bond resistance in uncracked concrete C20/25													
Hammer-drilling with standard drill bit or hollow drill bit (dry and wet concrete)													
Tem- perature range	I: 24 °C / 40 °C		$\tau_{Rk,ucr}$	[N/mm ²]	8,0	8,5	9,0	9,5	9,5	10	9,5	9,0	7,5
	II: 50 °C / 80 °C				8,0	8,5	9,0	9,0	9,5	9,5	9,0	8,5	7,5
	III: 72 °C / 120 °C				7,0	7,5	8,0	8,0	8,5	8,5	8,0	7,5	6,5
	IV: 90 °C / 150 °C				6,5	7,0	7,0	7,5	7,5	8,0	7,5	7,0	6,0
Cracked concrete													
Characteristic bond resistance in cracked concrete C20/25													
Hammer-drilling with standard drill bit or hollow drill bit (dry and wet concrete)													
Tem- perature range	I: 24 °C / 40 °C		$\tau_{Rk,cr}$	[N/mm ²]	4,5	6,0	6,0	6,0	7,0	6,0	6,0	6,0	6,0
	II: 50 °C / 80 °C				4,5	5,5	5,5	5,5	6,5	6,0	6,0	6,0	6,0
	III: 72 °C / 120 °C				4,0	5,0	5,0	5,0	6,0	5,5	5,5	5,5	5,5
	IV: 90 °C / 150 °C				3,5	4,5	4,5	4,5	5,5	5,0	5,0	5,0	5,0
Installation safety factors													
Dry and wet concrete		$\gamma_2 = \gamma_{inst}$	[-]	1,0									

fischer Superbond

Performances

Characteristic values for static or quasi-static action under tensile load for reinforcing bars with injection mortar FIS SB (uncracked or cracked concrete)

Annex C 9

Table C9: Characteristic values of resistance for fischer rebar anchors FRA in hammer drilled holes in combination with injection mortar FIS SB; uncracked or cracked concrete

Size			M12	M16	M20	M24
Combined pullout and concrete cone failure						
Calculation diameter	d	[mm]	12	16	20	25
Uncracked concrete						
Characteristic bond resistance in uncracked concrete C20/25						
Hammer-drilling with standard drill bit or hollow drill bit (dry and wet concrete)						
Temperature range	I: 24 °C / 40 °C	$\tau_{RK,ucr}$ [N/mm ²]	9,0	9,5	10	9,5
	II: 50 °C / 80 °C		9,0	9,5	9,5	9,0
	III: 72 °C / 120 °C		8,0	8,5	8,5	8,0
	IV: 90 °C / 150 °C		7,0	7,5	8,0	7,5
Cracked concrete						
Characteristic bond resistance in cracked concrete C20/25						
Hammer-drilling with standard drill bit or hollow drill bit (dry and wet concrete)						
Temperature range	I: 24 °C / 40 °C	$\tau_{RK,cr}$ [N/mm ²]	6,0	7,0	6,0	6,0
	II: 50 °C / 80 °C		5,5	6,5	6,0	6,0
	III: 72 °C / 120 °C		5,0	6,0	5,5	5,5
	IV: 90 °C / 150 °C		4,5	5,5	5,0	5,0
Installation safety factors						
Dry and wet concrete	$\gamma_2 = \gamma_{inst}$	[-]	1,0			

fischer Superbond

Performances

Characteristic values for static or quasi-static action under tensile load for fischer rebar anchors FRA with injection mortar FIS SB (uncracked or cracked concrete)

Annex C 10

Table C10: Displacements for anchor rods

Size	M8	M10	M12	M16	M20	M24	M27	M30	
Displacement-Factors for tensile load¹⁾									
Uncracked or cracked concrete; Temperature range I, II, III, IV									
δ_{N0} -Factor	[mm/(N/mm ²)]	0,07	0,08	0,09	0,10	0,11	0,12	0,12	0,13
$\delta_{N\infty}$ -Factor		0,13	0,14	0,15	0,17	0,17	0,18	0,19	0,19
Displacement-Factors for shear load²⁾									
Uncracked or cracked concrete; Temperature range I, II, III, IV									
δ_{V0} -Factor	[mm/kN]	0,18	0,15	0,12	0,09	0,07	0,06	0,05	0,05
$\delta_{V\infty}$ -Factor		0,27	0,22	0,18	0,14	0,11	0,09	0,08	0,07
¹⁾ Calculation of effective displacement: $\delta_{N0} = \delta_{N0}\text{-Factor} \cdot \tau_{Ed}$ $\delta_{N\infty} = \delta_{N\infty}\text{-Factor} \cdot \tau_{Ed}$ (τ_{Ed} : Design value of the applied tensile stress)					²⁾ Calculation of effective displacement: $\delta_{V0} = \delta_{V0}\text{-Factor} \cdot V_{Ed}$ $\delta_{V\infty} = \delta_{V\infty}\text{-Factor} \cdot V_{Ed}$ (V_{Ed} : Design value of the applied shear force)				

Table C11: Displacements for fischer internal threaded anchor RG MI

Size	M8	M10	M12	M16	M20	
Displacement-Factors for tensile load¹⁾						
Uncracked or cracked concrete; Temperature range I, II, III, IV						
δ_{N0} -Factor	[mm/(N/mm ²)]	0,09	0,10	0,10	0,11	0,19
$\delta_{N\infty}$ -Factor		0,13	0,15	0,15	0,17	0,19
Displacement-Factors for shear load²⁾						
Uncracked or cracked concrete; Temperature range I, II, III, IV						
δ_{V0} -Factor	[mm/kN]	0,12	0,09	0,08	0,07	0,05
$\delta_{V\infty}$ -Factor		0,18	0,14	0,12	0,10	0,08
¹⁾ Calculation of effective displacement: $\delta_{N0} = \delta_{N0}\text{-Factor} \cdot \tau_{Ed}$ $\delta_{N\infty} = \delta_{N\infty}\text{-Factor} \cdot \tau_{Ed}$ (τ_{Ed} : Design value of the applied tensile stress)			²⁾ Calculation of effective displacement: $\delta_{V0} = \delta_{V0}\text{-Factor} \cdot V_{Ed}$ $\delta_{V\infty} = \delta_{V\infty}\text{-Factor} \cdot V_{Ed}$ (V_{Ed} : Design value of the applied shear force)			

fischer Superbond

Performances

Displacements for anchor rods and fischer internal threaded anchors RG MI

Annex C 11

Table C12: Displacements for reinforcing bars

Nominal diameter of the bar ϕ	8	10	12	14	16	20	25	28	32	
Displacement-Factors for tensile load¹⁾										
Uncracked or cracked concrete; Temperature range I, II, III, IV										
δ_{N0} -Factor	[mm/(N/mm ²)]	0,07	0,08	0,09	0,09	0,10	0,11	0,12	0,13	0,13
$\delta_{N\infty}$ -Factor		0,11	0,13	0,13	0,15	0,16	0,16	0,18	0,20	0,20
Displacement-Factors for shear load²⁾										
Uncracked or cracked concrete; Temperature range I, II, III, IV										
δ_{V0} -Factor	[mm/kN]	0,18	0,15	0,12	0,10	0,09	0,07	0,06	0,05	0,05
$\delta_{V\infty}$ -Factor		0,27	0,22	0,18	0,16	0,14	0,11	0,09	0,08	0,06

1) Calculation of effective displacement:

$$\delta_{N0} = \delta_{N0\text{-Factor}} \cdot \tau_{Ed}$$

$$\delta_{N\infty} = \delta_{N\infty\text{-Factor}} \cdot \tau_{Ed}$$

(τ_{Ed} : Design value of the applied tensile stress)

2) Calculation of effective displacement:

$$\delta_{V0} = \delta_{V0\text{-Factor}} \cdot V_{Ed}$$

$$\delta_{V\infty} = \delta_{V\infty\text{-Factor}} \cdot V_{Ed}$$

(V_{Ed} : Design value of the applied shear force)

Table C13: Displacements for fischer rebar anchors FRA

Size	M12	M16	M20	M24	
Displacement-Factors for tensile load¹⁾					
Uncracked or cracked concrete; Temperature range I, II, III, IV					
δ_{N0} -Factor	[mm/(N/mm ²)]	0,09	0,10	0,11	0,12
$\delta_{N\infty}$ -Factor		0,13	0,15	0,16	0,18
Displacement-Factors for shear load²⁾					
Uncracked or cracked concrete; Temperature range I, II, III, IV					
δ_{V0} -Factor	[mm/kN]	0,12	0,09	0,07	0,06
$\delta_{V\infty}$ -Factor		0,18	0,14	0,11	0,09

1) Calculation of effective displacement:

$$\delta_{N0} = \delta_{N0\text{-Factor}} \cdot \tau_{Ed}$$

$$\delta_{N\infty} = \delta_{N\infty\text{-Factor}} \cdot \tau_{Ed}$$

(τ_{Ed} : Design value of the applied tensile stress)

2) Calculation of effective displacement:

$$\delta_{V0} = \delta_{V0\text{-Factor}} \cdot V_{Ed}$$

$$\delta_{V\infty} = \delta_{V\infty\text{-Factor}} \cdot V_{Ed}$$

(V_{Ed} : Design value of the applied shear force)

fischer Superbond

Performances

Displacements for reinforcing bars and fischer rebar anchors FRA

Annex C 12

Table C14: Characteristic values for the **steel bearing capacity** under tensile / shear load of **fischer anchor rods** and **standard threaded rods** under seismic action performance category **C1** or **C2**

Size		M8	M10	M12	M16	M20	M24	M27	M30		
Bearing capacity under tensile load, steel failure¹⁾											
fischer anchor rods and standard threaded rods, performance category C1											
Charact.bearing capacity $N_{Rk,s,C1}$	Steel zinc plated	5.8	[kN]	19	29	43	79	123	177	230	281
		8.8		30	47	68	126	196	282	368	449
	Stainless steel A4 and High corrosion resistant steel C	50		19	29	43	79	123	177	230	281
		70		26	41	59	110	172	247	322	393
		80		30	47	68	126	196	282	368	449
fischer anchor rods and standard threaded rods, performance category C2											
Charact.bearing capacity $N_{Rk,s,C2}$	Steel zinc plated	5.8	[kN]	---	---	39	72	108	177	---	---
		8.8		---	---	61	116	173	282	---	---
	Stainless steel A4 and High corrosion resistant steel C	50		---	---	39	72	108	177	---	---
		70		---	---	53	101	152	247	---	---
		80		---	---	61	116	173	282	---	---
Bearing capacity under shear load, steel failure without lever arm¹⁾											
fischer anchor rods, performance category C1											
Charact.bearing capacity $V_{Rk,s,C1}$	Steel zinc plated	5.8	[kN]	9	15	21	39	61	89	115	141
		8.8		15	23	34	63	98	141	184	225
	Stainless steel A4 and High corrosion resistant steel C	50		9	15	21	39	61	89	115	141
		70		13	20	30	55	86	124	161	197
		80		15	23	34	63	98	141	184	225
Standard threaded rods, performance category C1											
Charact.bearing capacity $V_{Rk,s,C1}$	Steel zinc plated	5.8	[kN]	6	11	15	27	43	62	81	99
		8.8		11	16	24	44	69	99	129	158
	Stainless steel A4 and High corrosion resistant steel C	50		6	11	15	27	43	62	81	99
		70		9	14	21	39	60	87	113	138
		80		11	16	24	44	69	99	129	158
fischer anchor rods and standard threaded rods, performance category C2											
Charact.bearing capacity $V_{Rk,s,C2}$	Steel zinc plated	5.8	[kN]	---	---	14	27	43	62	---	---
		8.8		---	---	22	44	69	99	---	---
	Stainless steel A4 and High corrosion resistant steel C	50		---	---	14	27	43	62	---	---
		70		---	---	20	39	60	87	---	---
		80		---	---	22	44	69	99	---	---

¹⁾ Partial safety factors for performance category C1 or C2 see Table C16, for fischer anchor rods FIS A / RG M the factor for steel ductility is 1,0

fischer Superbond

Performances

Characteristic steel bearing capacity of fischer anchor rods and standard threaded rods under seismic action (performance category C1 or C2)

Annex C 13

Table C15: Characteristic values for the steel bearing capacity under tensile / shear load of reinforcing bars (B500B) under seismic action performance category C1

Nominal diameter of the bar		ϕ	8	10	12	14	16	20	25	28	32
Bearing capacity under tensile load, steel failure¹⁾											
Reinforcing bar B500B acc. to DIN 488-2:2009-08, performance category C1											
Characteristic bearing capacity	$N_{Rk,s,C1}$	[kN]	28	44	63	85	111	173	270	339	443
Bearing capacity under shear load, steel failure without lever arm¹⁾											
Reinforcing bar B500B acc. to DIN 488-2:2009-08, performance category C1											
Characteristic bearing capacity	$V_{Rk,s,C1}$	[kN]	10	15	22	30	39	61	95	119	155

¹⁾ Partial safety factors for performance category C1 see Table C16

Table C16: Partial safety factors of fischer anchor rods, standard threaded rods and reinforcing bars (B500B) under seismic action performance category C1 or C2

Size		M8	M10	M12	M16	M20	M16	M24	M27	M30	
Nominal diameter of the bar		ϕ	8	10	12	14	16	20	25	28	32
Bearing capacity under tensile load, steel failure¹⁾											
Partial safety factor $\gamma_{Ms,N}$	Steel zinc plated	5.8	[-]	1,50							
		8.8		1,50							
	Stainless steel A4 and High corrosion resistant steel C	50		2,86							
		70		1,50 ²⁾ / 1,87							
	Reinforcing bar	80		1,60							
		B500B		1,40							
Bearing capacity under shear load, steel failure¹⁾											
Partial safety factor $\gamma_{Ms,V}$	Steel zinc plated	5.8	[-]	1,25							
		8.8		1,25							
	Stainless steel A4 and High corrosion resistant steel C	50		2,38							
		70		1,25 ²⁾ / 1,56							
	Reinforcing bar	80		1,33							
		B500B		1,50							

¹⁾ In absence of other national regulations

²⁾ Only admissible for steel C, with $f_{yk} / f_{uk} \geq 0,8$ and $A_s > 12\%$ (e.g. fischer anchor rods)

fischer Superbond

Performances

Characteristic steel bearing capacity of reinforcing bars under seismic action (performance category C1); partial safety factors (performance category C1 or C2)

Annex C 14

Table C17: Characteristic values of **resistance** for **fischer anchor rods** and **standard threaded rods** in hammer drilled holes with **injection mortar FIS SB** and **resin capsule RSB** under seismic action performance category **C1**

Size	M8	M10	M12	M16	M20	M24	M27 ¹⁾	M30		
Characteristic bond resistance, combined pullout and concrete cone failure										
Hammer-drilling with standard drill bit or hollow drill bit (dry and wet concrete; resin capsule RSB additional in flooded hole)										
Tem- perature range	I: 24 °C / 40 °C	$\tau_{Rk,C1}$	[N/mm ²]	4,6	5,0	5,6	5,6	5,6	6,4	
	II: 50 °C / 80 °C			4,3	4,6	5,6	5,6	5,6	5,3	6,0
	III: 72 °C / 120 °C			3,9	4,3	4,9	4,9	4,9	4,5	5,1
	IV: 90 °C / 150 °C			3,6	3,9	4,5	4,5	4,5	4,1	4,7
Installation safety factors										
Bearing capacity under tensile load										
Dry and wet concrete	$\gamma_2 = \gamma_{inst}$	[-]	1,0							
Flooded hole			1,2 ²⁾	1,0 ²⁾						
Bearing capacity under shear load										
All installation conditions	$\gamma_2 = \gamma_{inst}$	[-]	1,0							

¹⁾ Only use with injection mortar FIS SB

²⁾ Only use with resin capsule RSB in flooded hole

Table C18: Characteristic values of **resistance** for **reinforcing bars** in hammer drilled holes with **injection mortar FIS SB** under seismic action performance category **C1**

Nominal diameter of the bar	ϕ	8	10	12	14	16	20	25	28	32		
Characteristic bond resistance, combined pullout and concrete cone failure												
Hammer-drilling with standard drill bit or hollow drill bit (dry and wet concrete)												
Tem- perature range	I: 24 °C / 40 °C	$\tau_{Rk,C1}$	[N/mm ²]	3,2	4,3	4,5	4,5	5,3	4,5	4,5	5,1	
	II: 50 °C / 80 °C			3,2	3,9	4,1	4,1	4,9	4,5	4,5	4,5	5,1
	III: 72 °C / 120 °C			2,8	3,6	3,8	3,8	4,5	4,1	4,1	4,1	4,7
	IV: 90 °C / 150 °C			2,5	3,2	3,4	3,4	4,1	3,8	3,8	3,8	4,3
Installation safety factors												
Bearing capacity under tensile load												
Dry and wet concrete	$\gamma_2 = \gamma_{inst}$	[-]	1,0									
Bearing capacity under shear load												
All installation conditions	$\gamma_2 = \gamma_{inst}$	[-]	1,0									

fischer Superbond

Performances

Characteristic values under seismic action (performance category C1) for fischer anchor rods, standard threaded rods and reinforcing bars

Annex C 15

Table C19: Characteristic values of **resistance** for **fischer anchor rods** and **standard threaded rods** in hammer drilled holes with **injection mortar FIS SB** under seismic action performance category **C2**

Size		M12	M16	M20	M24	
Characteristic bond resistance, combined pullout and concrete cone failure						
Hammer-drilling with standard drill bit or hollow drill bit (dry and wet concrete)						
Temperature range	I: 24 °C / 40 °C	$\tau_{Rk,C2}$ [N/mm ²]	4,5	3,2	2,6	3,0
	II: 50 °C / 80 °C		4,5	3,2	2,6	3,0
	III: 72 °C / 120 °C		3,9	2,7	2,3	2,6
	IV: 90 °C / 150 °C		3,6	2,5	2,1	2,4
Installation safety factors						
Bearing capacity under tensile load						
Dry and wet concrete	$\gamma_2 = \gamma_{inst}$	[-]	1,0			
Bearing capacity under shear load						
All installation conditions	$\gamma_2 = \gamma_{inst}$	[-]	1,0			
Displacement-Factors for tensile load¹⁾						
$\delta_{N,(DLS)-Factor}$	[mm/(N/mm ²)]	0,09	0,10	0,11	0,12	
$\delta_{N,(ULS)-Factor}$		0,15	0,17	0,17	0,18	
Displacement-Factors for shear load²⁾						
$\delta_{V,(DLS)-Factor}$	[mm/kN]	0,18	0,10	0,07	0,06	
$\delta_{V,(ULS)-Factor}$		0,25	0,14	0,11	0,09	

¹⁾ Calculation of effective displacement:

$$\delta_{N,(DLS)} = \delta_{N,(DLS)-Factor} \cdot \tau_{Ed}$$

$$\delta_{N,(ULS)} = \delta_{N,(ULS)-Factor} \cdot \tau_{Ed}$$

(τ_{Ed} : Design value of the applied tensile stress)

²⁾ Calculation of effective displacement:

$$\delta_{V,(DLS)} = \delta_{V,(DLS)-Factor} \cdot V_{Ed}$$

$$\delta_{V,(ULS)} = \delta_{V,(ULS)-Factor} \cdot V_{Ed}$$

(V_{Ed} : Design value of the applied shear force)

fischer Superbond

Performances

Characteristic values under seismic action (performance category C2) for fischer anchor rods and standard threaded rods

Annex C 16