

PRESTATIEVERKLARING

DoP 0367

voor fischer injectiesysteem FIS EM Plus (Mortel voor achteraf aangebrachte wapeningsverbindingen)

NL

- Unieke identificatiecode van het producttype: DoP 0367
- Beoogd(e) gebruik(en): **Systeem voor achteraf aangebrachte wapeningsverbinding met mortel voor toepassing in beton, Zie bijlage, met name de bijlagen B1-B11.**
- Fabrikant: **fischerwerke GmbH & Co. KG, Otto-Hahn-Straße 15, 79211 Denzlingen, Duitsland**
- Gemachtigde: -
- Het systeem of de systemen voor de beoordeling en verificatie van de prestatiebestendigheid: 1
- Europees beoordelingsdocument: **EAD 330087-01-0601 Edition 06/2021**
Europese technische beoordeling: **ETA-17/1056; 2024-11-01**
Technische beoordelingsinstantie: **DIBt- Deutsches Institut für Bautechnik**
Aangemelde instantie(s): **2873 TU Darmstadt**
- Aangegeven prestatie(s):
Mechanische weerstand en stabiliteit (BWR 1)
Kenmerkende weerstand onder statische en quasi-statische belasting:
Hechtsterkte van achteraf aangebrachte wapening: Bijlage C2
Reductiefactor: Bijlage C1
Versterkingsfactor voor minimale verankeringslengte: Bijlage C1
Kenmerkende weerstand tegen staalbreuk voor wapeningsankers: Bijlage C1

Kenmerkende weerstand onder seismische belasting:
Verbindingssterkte onder seismische belasting, Seismische bindingsefficiëntiefactor: Bijlage C3
imale betondekking onder seismische belasting: Bijlage B5

Veiligheid in geval van brand (BWR 2)
Reactie op brand: Klasse (A1)

Weerstand tegen vuur:
Hechtsterkte bij verhoogde temperatuur voor achteraf aangebrachte wapening beoordeeld voor 50 jaar: Bijlage C5
Hechtsterkte bij verhoogde temperatuur voor achteraf aangebrachte wapening beoordeeld voor 100 jaar: Bijlage C5
'Kenmerkende weerstand tegen staalbreuk voor wapeningsankers onder invloed van vuur: Bijlage C4
- Geëigende technische documentatie en/of specifieke technische documentatie: -

De prestaties van het hierboven omschreven product zijn conform de aangegeven prestaties. Deze prestatieverklaring wordt in overeenstemming met Verordening (EU) nr. 305/2011 onder de exclusieve verantwoordelijkheid van de hierboven vermelde fabrikant verstrekt.

Ondertekend voor en namens de fabrikant door:



Dr.-Ing. Ronald Mihala, Hoofd ontwikkeling en productiebeheer
Tumlingen, 2024-11-19



Jürgen Grün, Directeur Chemie & Kwaliteit

Deze DoP is opgesteld in meerdere talen. In het geval van geschillen over de interpretatie zal de Engelse tekst altijd prevaleren.

Het aanhangsel bevat vrijwillige en aanvullende informatie in het Engels die de (taal-neutraal gespecificeerde) wettelijke vereisten overschrijdt.

Translation guidance Essential Characteristics and Performance Parameters for Annexes

Vertaal assistent van de essentiële kenmerken en eigenschappen voor bijlagen

Mechanical resistance and stability (BWR 1)		
Mechanische weerstand en stabiliteit (BWR 1)		
Characteristic resistance under static and quasi-static loading: Kenmerkende weerstand onder statische en quasi-statische belasting:		
1	Bond strength of post-installed rebar: Hechtsterkte van achteraf aangebrachte wapening:	$f_{bd,PIR}$ [N/mm ²], $f_{bd,PIR,100y}$ [N/mm ²]
2	Bond efficiency factor: Reductiefactor:	k_b [-], $k_{b,100y}$ [-]
3	Amplification factor for minimum anchorage length: Versterkingsfactor voor minimale verankeringslengte:	α_{lb} [-], $\alpha_{lb,100y}$ [-]
4	Characteristic resistance to steel failure for rebar tension anchors: Kenmerkende weerstand tegen staalbreuk voor wapeningsankers:	$N_{RK,s}$ [kN]
Characteristic resistance under seismic loading: Kenmerkende weerstand onder seismische belasting:		
5	Bond strength under seismic loading, Seismic bond efficiency factor: Verbindingssterkte onder seismische belasting, Seismische bindingsefficiëntiefactor:	$f_{bd,PIR,seis}$ [N/mm ²], $k_{b,seis}$ [-], $f_{bd,PIR,seis,100y}$ [N/mm ²], $k_{b,seis,100y}$ [-]
6	Minimum concrete cover under seismic loading: Minimale betondekking onder seismische belasting:	$c_{min,seis}$ [mm]
Safety in case of fire (BWR 2)		
Veiligheid in geval van brand (BWR 2)		
7	Reaction to fire: Reactie op brand:	Class
Resistance to fire: Weerstand tegen vuur:		
8	Bond strength at increased temperature for post-installed rebar assessed for 50 years: Hechtsterkte bij verhoogde temperatuur voor achteraf aangebrachte wapening beoordeeld voor 50 jaar:	$f_{bd,fi}(\theta)$ [N/mm ²], $k_{fi}(\theta)$ [-], θ_{max} [°C]
9	Bond strength at increased temperature for post-installed rebar assessed for 100 years: Hechtsterkte bij verhoogde temperatuur voor achteraf aangebrachte wapening beoordeeld voor 100 jaar:	$f_{bd,fi,100y}(\theta)$ [N/mm ²], $k_{fi,100y}(\theta)$ [-], θ_{max} [°C]
10	Characteristic resistance to steel failure for rebar tension anchors under fire exposure: Kenmerkende weerstand tegen staalbreuk voor wapeningsankers onder invloed van vuur:	$N_{RK,s,fi}$ [kN]

Specific Part

1 Technical description of the product

The subject of this European Technical Assessment is the post-installed connection, by anchoring or overlap connection joint, of reinforcing bars (rebars) in existing structures made of normal weight concrete, using the "Rebar connection with fischer injection mortar FIS EM Plus" in accordance with the regulations for reinforced concrete construction.

Reinforcing bars with a diameter ϕ from 8 to 40 mm or the fischer rebar anchor FRA of sizes M12 to M24 according to Annex A and the fischer injection mortar FIS EM Plus are used for the post-installed rebar connection. The steel element is placed into a drilled hole filled with injection mortar and is anchored via the bond between embedded reinforcing bar, injection mortar and concrete. The product description is given in Annex A.

2 Specification of the intended use in accordance with the applicable European assessment Document

The performances given in Section 3 are only valid if the rebar connection is used in compliance with the specifications and conditions given in Annex B.

The verifications and assessment methods on which this European Technical Assessment is based lead to the assumption of a working life of the rebar connections of at least 50 and/or 100 years. The indications given on the working life cannot be interpreted as a guarantee given by the producer, but are to be regarded only as a means for choosing the right products in relation to the expected economically reasonable working life of the works.

3 Performance of the product and references to the methods used for its assessment

3.1 Mechanical resistance and stability (BWR 1)

Essential characteristic	Performance
Characteristic resistance under static and quasi-static loading	See Annex C 1 and C2
Characteristic resistance under seismic loading	See Annex B 5 and C 3

3.2 Safety in case of fire (BWR 2)

Essential characteristic	Performance
Reaction to fire	Class A1
Resistance to fire	See Annex C 4 and C 5

4 Assessment and verification of constancy of performance (AVCP) system applied, with reference to its legal base

In accordance with European Assessment Document EAD No. 330087-01-0601, the applicable European legal act is: [96/582/EC].

The system to be applied is: 1

Installation conditions and application examples reinforcing bars, part 1

Figure A1.1:

Overlap joint with existing reinforcement for rebar connections of slabs and beams

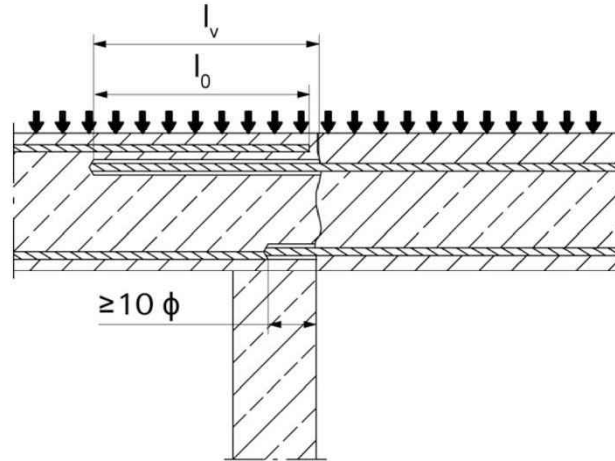

Figure A1.2:

Overlap joint with existing reinforcement at a foundation of a column or wall where the rebar is stressed

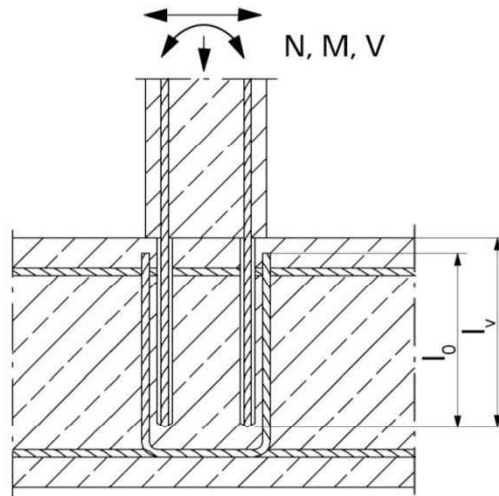
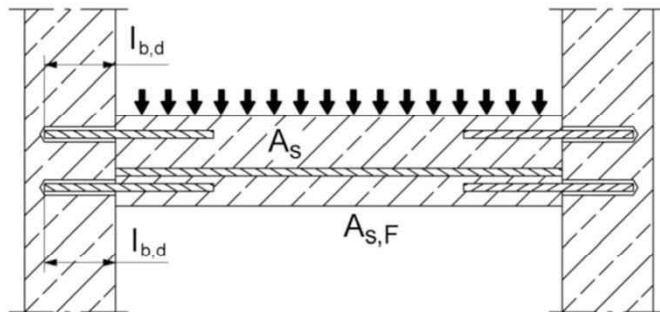

Figure A1.3:

End anchoring of slabs or beams (e.g. designed as simply supported)



Figures not to scale

Rebar connection with fischer injection mortar FIS EM Plus

Product description

Installation conditions and application examples reinforcing bars, part 1

Annex A1

Appendix 2 / 24

Installation conditions and application examples reinforcing bars, part 2

Figure A2.1:

Rebar connection for stressed primarily in compression

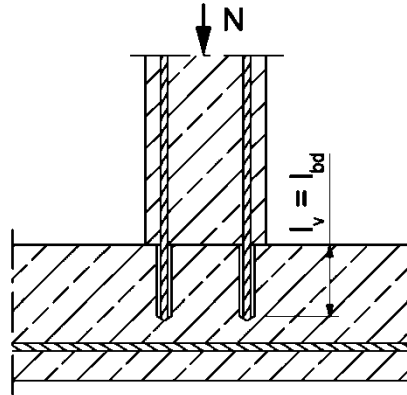
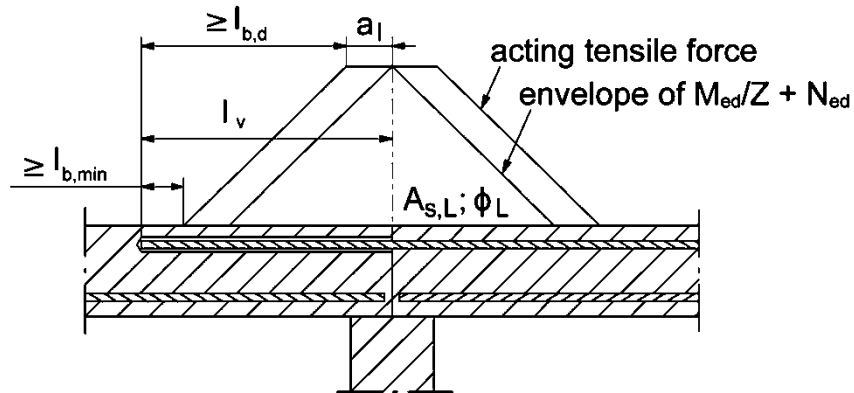

Figure A2.2:

Anchoring of reinforcement to cover the enveloped line of acting tensile force in the bending member



Note to **figure A1.1** to **A1.3** and **figure A2.1** to **A2.2**

In the figures no traverse reinforcement is plotted, the traverse reinforcement shall comply with EN 1992-1-1:2011.

Preparing of joints according to **Annex B2**

Figures not to scale

Rebar connection with fischer injection mortar FIS EM Plus

Product description

Installation conditions and application examples reinforcing bars, part 2

Annex A2

Appendix 3 / 24

Installation conditions and application examples fischer rebar anchor, part 3

Figure A3.1:

Lap to a foundation of a column under bending.

1. Shear lug (or fastener loaded in shear)
2. fischer Rebar tension anchor (tension only)
3. Existing stirrup / reinforcement for overlap (lap splice)
4. Slotted hole

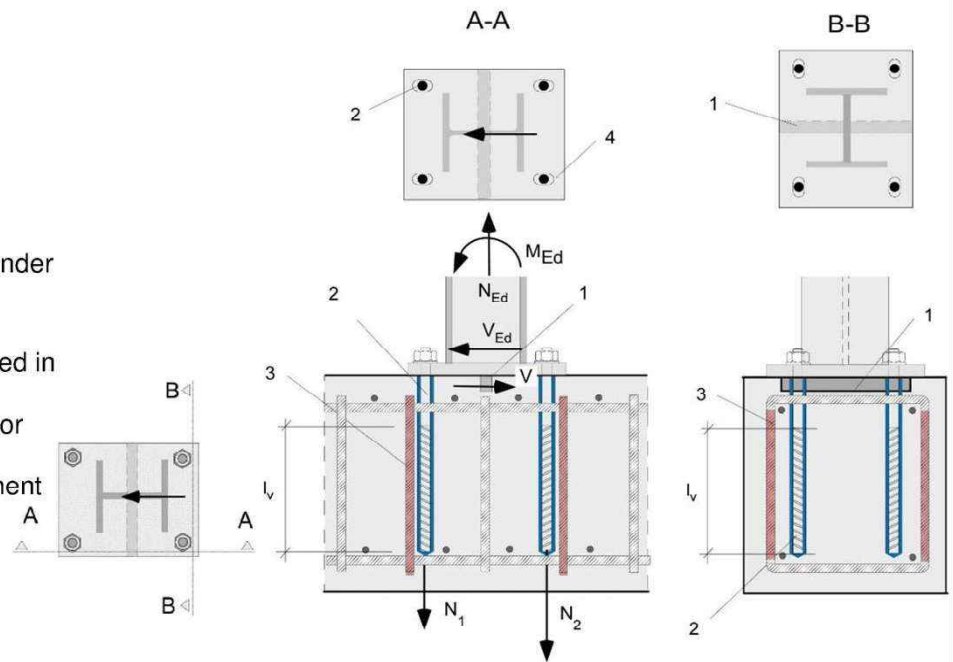
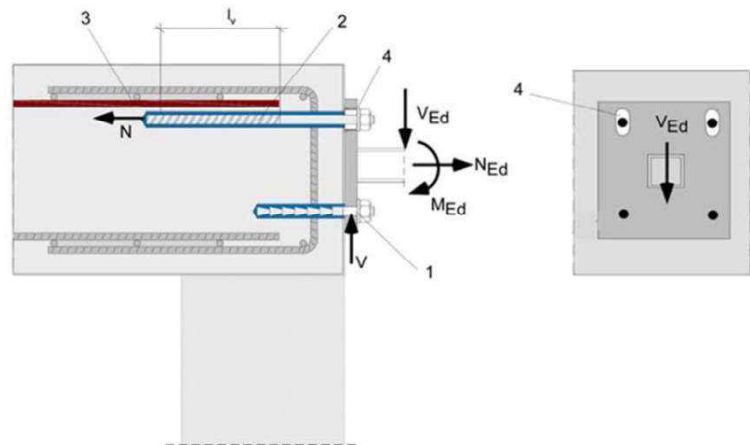

Figure A3.2:

Lap of the anchoring of guardrail posts or anchoring of cantilevered building components.

In the anchor plate, the drill holes for the fischer rebar anchors have to be designed as slotted holes with axial direction to the shear force.

1. Fastener for shear load transfer
2. fischer rebar tension anchor (tension only)
3. Existing stirrup / reinforcement for overlap (lap splice)
4. Slotted hole



The required transverse reinforcement acc. to EN 1992-1-1:2011 is not shown in the figures. **The fischer rebar anchor may be only used for axial tensile force.** The tensile force must be transferred by lap to the existing reinforcement of the building. The transfer of the shear force has to be ensured by suitable measure, e.g. by means of shear force or anchors with European Technical Assessment (ETA).

Figures not to scale

Rebar connection with fischer injection mortar FIS EM Plus

Product description

Installation conditions and application examples fischer rebar anchors, part 3

Annex A3

Appendix 4 / 24

Overview system components Part 1

Injection cartridge (shuttle cartridge) FIS EM Plus with sealing cap

Sizes: 390 ml, 585 ml, 1100 ml, 1500 ml

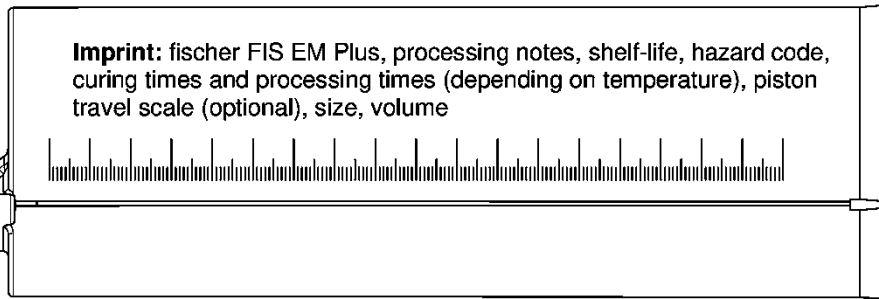
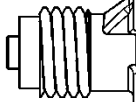
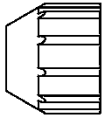

Injection cartridge (coaxial cartridge) FIS EM Plus with sealing cap

Sizes: 300 ml

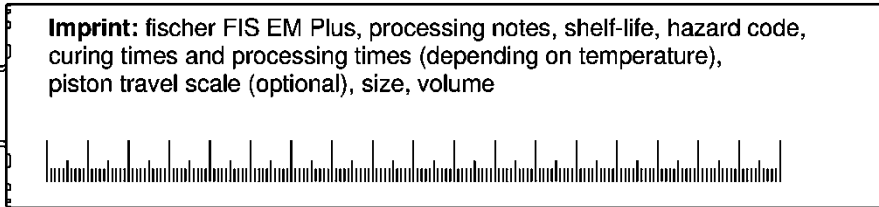
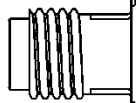
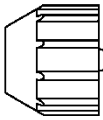

Static mixer FIS MR Plus for injection cartridge 300 ml and 390 ml

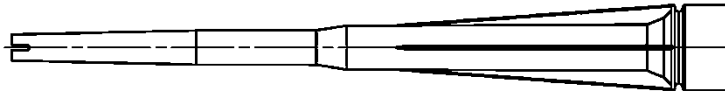

Static mixer FIS UMR for injection cartridge 585 ml to 1500 ml

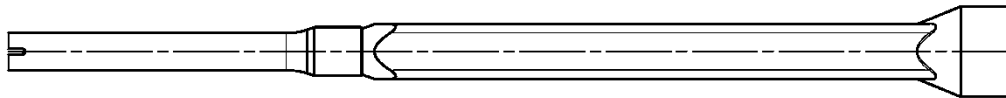

Injection adapter and extension tube Ø 9 for static mixer FIS MR Plus; Injection adapter and extension tube Ø 9 or Ø 15 for static mixer FIS UMR

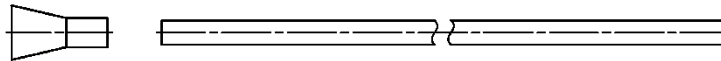

Blow out pump ABP



Figures not to scale

Rebar connection with fischer injection mortar FIS EM Plus

Product description

Overview system components Part 1;
Injection mortar, Blow out pump

Annex A4

Appendix 5 / 24

Overview system components Part 2

Reinforcing bar (rebar)

Sizes: $\phi 8$, $\phi 10$, $\phi 12$, $\phi 14$, $\phi 16$, $\phi 20$, $\phi 22$, $\phi 24$, $\phi 25$, $\phi 26$, $\phi 28$, $\phi 30$, $\phi 32$, $\phi 34$, $\phi 36$, $\phi 40$

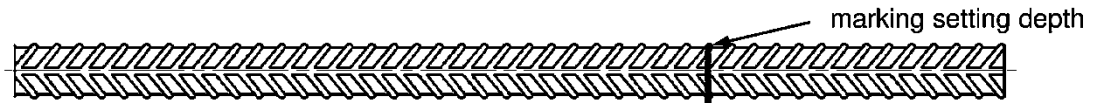

fischer rebar anchor FRA, FRA HCR

Sizes: M12, M16, M20, M24



Figures not to scale

Rebar connection with fischer injection mortar FIS EM Plus

Product description

Overview system components Part 2;
Reinforcing bar, fischer rebar anchor

Annex A5

Appendix 6 / 24

Properties of reinforcing bars (rebar)

Figure A6.1:



- The minimum value of related rip area $f_{R,min}$ according to EN 1992-1-1:2011
- The maximum outer rebar diameter over the ribs shall be:
 - The nominal diameter of the rip $\phi + 2 \cdot h$ ($h \leq 0,07 \cdot \phi$)
 - (ϕ : Nominal diameter of the bar; h : rip height of the bar)

Table A6.1: Installation conditions for rebars

Nominal diameter of the bar		ϕ	8 ¹⁾		10 ¹⁾		12 ¹⁾		14	16	20	22	24
Nominal drill hole diameter	d_0	[mm]	10	12	12	14	14	16	18	20	25	30	30
Drill hole depth	h_0		$h_0 = l_v$										
Effective embedment depth	l_v		acc. to static calculation										
Minimum thickness of concrete member	h_{min}		$l_v + 30$ (≥ 100)					$l_v + 2d_0$					

Nominal diameter of the bar		ϕ	25 ¹⁾		26	28	30	32	34	36	40	
Nominal drill hole diameter	d_0	[mm]	30	35	35	35	40	40	40	45	55	
Drill hole depth	h_0		$h_0 = l_v$									
Effective embedment depth	l_v		acc. to static calculation									
Minimum thickness of concrete member	h_{min}		$l_v + 2d_0$									

¹⁾ Both drill hole diameters can be used

Table A6.2: Materials of rebars

Designation	Reinforcing bar (rebar)
Reinforcing bar EN 1992-1-1:2011, Annex C	Bars and de-coiled rods class B or C with f_{yk} and k according to NDP or NCL of EN 1992-1-1/NA $f_{uk} = f_{tk} = k \cdot f_{yk}$

Figures not to scale

Rebar connection with fischer injection mortar FIS EM Plus

Product description
Properties and materials of reinforcing bars (rebar)

Annex A6
Appendix 7 / 24

Properties of fischer rebar anchor

Figure A7.1:

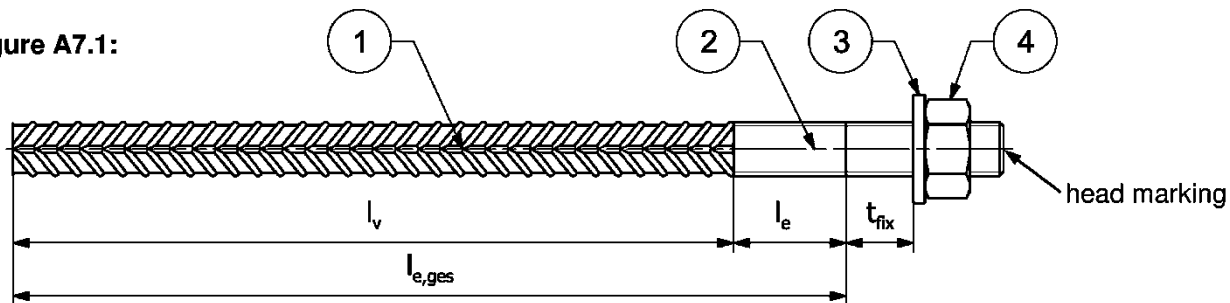

Head marking e.g.:  FRA (for stainless steel)

 FRA HCR (for high corrosion-resistant steel)

Table A7.1: Installation conditions for fischer rebar anchors

Threaded diameter		M12 ²⁾		M16	M20	M24 ²⁾	
Nominal diameter	ϕ [mm]	12		16	20	25	
Width across flat	SW [mm]	19		24	30	36	
Nominal drill bit diameter	d_0 [mm]	14	16	20	25	30	35
Drill hole depth ($h_0 = l_{ges}$)	$l_{e,ges}$ [mm]	$l_v + l_e$					
Effective embedment depth	l_v [mm]	acc. to static calculation					
Distance concrete surface to welded joint	l_e [mm]	100					
Diameter of clearance hole in the fixture ¹⁾	Pre-positioned $\leq d_f$ [mm]	14		18	22	26	
	Push through $\leq d_f$ [mm]	16	18	22	26	32	40
Minimum thickness of concrete member	h_{min} [mm]	$h_0 + 30$ (≥ 100)		$h_0 + 2d_0$			
Maximum torque moment for attachment of the fixture	$\max T_{fix}$ [Nm]	50		100	150	150	

¹⁾ For bigger clearance holes in the fixture see EN 1992-4:2018

²⁾ Both drill bit diameters can be used

Table A7.2: Materials of fischer rebar anchors

Part	Description	Materials	
		FRA Corrosion resistance class CRC III acc. to EN 1993-1-4:2015	FRA HCR Corrosion resistance class CRC V acc. to EN 1993-1-4:2015
1	Reinforcing bar	Bars and de-coiled rods class B or C with f_{yk} and k according to NDP or NCL of EN 1992-1-1:NA; $f_{uk} = f_{tk} = k \cdot f_{yk}$	
2	Round bar with partial or full thread	Stainless steel, strength class 80, according to EN 10088-1:2014	High corrosion-resistant steel, strength class 80, according to EN 10088-1:2014
3	Washer ISO 7089:2000	Stainless steel, according to EN 10088-1:2014	High corrosion-resistant steel, according to EN 10088-1:2014
4	Hexagon nut	Stainless steel, strength class 80, acc. to EN ISO 3506-2:2020 according to EN 10088-1:2014	High corrosion-resistant steel, strength class 80, acc. to EN ISO 3506-2:2020 according to EN 10088-1:2014

Figures not to scale





Rebar connection with fischer injection mortar FIS EM Plus

Product description
Properties and materials of fischer rebar anchors

Annex A7
Appendix 8 / 24

Specifications of intended use (part 1)

Table B1.1: Overview use and performance categories

Anchorages subject to		FIS EM Plus with ...			
		Reinforcing bar		fischer rebar anchor	
					
Hammer drilling with standard drill bit		all sizes			
Hammer drilling with hollow drill bit (fischer "FHD", Heller "Duster Expert"; Bosch "Speed Clean"; Hilti "TE-CD, TE-YD")		Nominal drill bit diameter (d_0) 12 mm to 35 mm			
Diamond drilling		all sizes			
Static and quasi static load, in	uncracked concrete	all sizes	Tables: C1.1 C1.2 C1.3 C2.1	all sizes	Tables: C1.1 C1.2 C1.3 C1.4 C2.1
	cracked concrete				
Seismic action (only hammer drilling with standard / hollow drill bits)		all sizes	Tables: C3.1 C3.2 C3.3	no performance assessed	
Installation temperature	$T_{i,min} = -5\text{ °C}$ to $T_{i,max} = +40\text{ °C}$				
Resistance to fire	all sizes	Annex C5	all sizes	Annex C4	
Rebar connection with fischer injection mortar FIS EM Plus					Annex B1 Appendix 9 / 24
Intended use Specifications (part 1)					

Specifications of intended use (part 2)

Anchorage subject to:

- Static, quasi-static and seismic loads: reinforcing bar (rebar) size 8 mm to 40 mm
- Resistance to fire

Base materials:

- Compacted reinforced or unreinforced normal weight concrete without fibres according to EN 206:2013+A1:2016
- Strength classes C12/15 to C50/60 according to EN 206:2013+A1:2016
- Maximum chloride content of 0,40 % (CL 0.40) related to the cement content according to EN 206:2013+A1:2016
- Non-carbonated concrete

Note: In case of a carbonated surface of the existing concrete structure the carbonated layer shall be removed in the area of the post-installed rebar connection with a diameter of $\phi + 60$ mm prior to the installation of the new rebar. The depth of concrete to be removed shall correspond to at least the minimum concrete cover in accordance with EN 1992-1-1:2011. The foregoing may be neglected if building components are new and not carbonated and if building components are in dry conditions

Temperature Range:

- - 40°C to +80°C (max. short term temperature +80°C and max long term temperature +50°C).

Installation temperature:

- -5 °C to +40 °C

Use conditions (Environmental conditions) for fischer rebar anchors:

- For all conditions according to EN1993-1-4:2015 corresponding to corrosion resistance classes to Annex A7 table A7.2

Design:

- The structural design according to EN 1992-1-1:2011, EN 1992-1-2:2011 and Annex B3 and B4 are conducted under responsibility of a designer experienced in the field of anchorages and concrete works.
- Verifiable calculation notes and drawings are prepared taking account of the forces to be transmitted.
- The actual position of the reinforcement in the existing structure shall be determined on the basis of the construction documentation and taken into account when designing.

Installation:

- Dry or wet concrete
- It must not be installed in water filled holes
- Hole drilling by hammer drill, hollow drill, compressed air drill or diamond drill mode
- Overhead installation allowed
- The installation of post-installed rebar respectively fischer rebar anchor shall be done only by suitable trained installer and under Supervision on site; the conditions under which an installer may be considered as suitable trained and the conditions for Supervision on site are up to the Member States in which the installation is done.
- Check the position of the existing rebars (if the position of existing rebars is not known, it shall be determined using a rebar detector suitable for this purpose as well as on the basis of the construction documentation and then marked on the building component for the overlap joint).

Rebar connection with fischer injection mortar FIS EM Plus

Intended use
Specifications (part 2)

Annex B2
Appendix 10 / 24

General construction rules for post-installed rebars

Figure B3.1:

- Only tension forces in the axis of the rebar may be transmitted
- The transfer of shear forces between new concrete and existing structure shall be designed additionally according to EN 1992-1-1:2011.
- The joints for concreting must be roughened to at least such an extent that aggregate protrude.

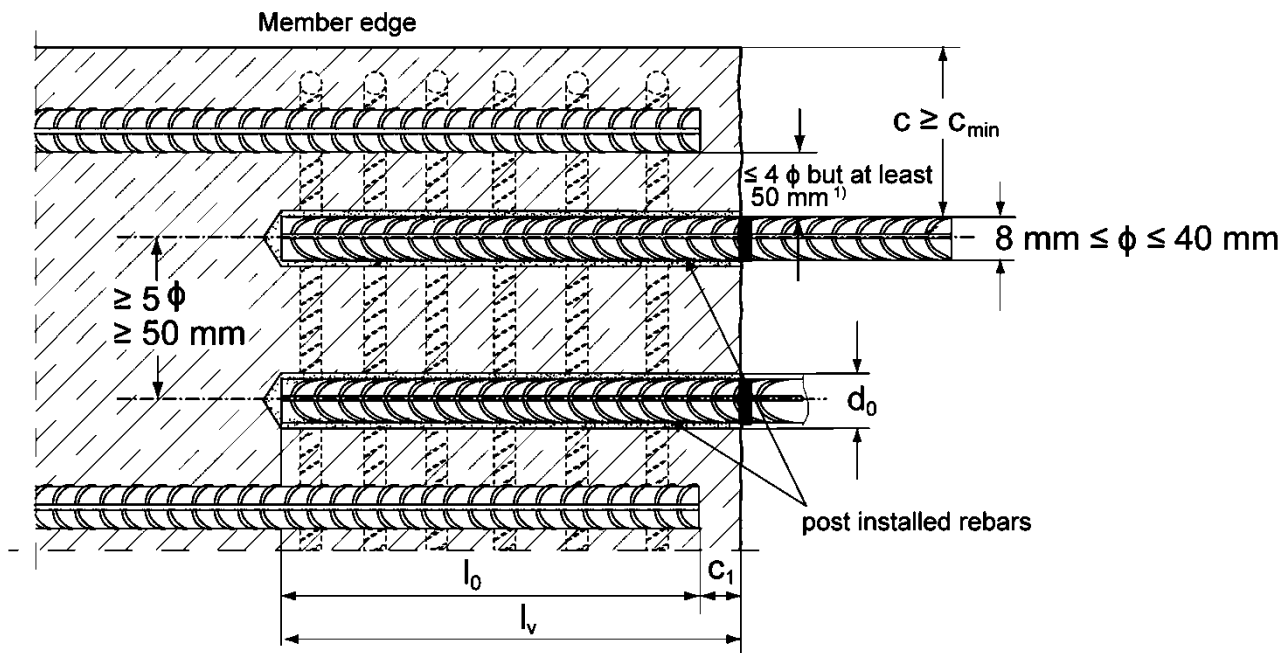

1) If the clear distance between lapped bars exceeds 4ϕ but at least 50 mm then the lap length shall be increased by the difference between the clear bar distance and 4ϕ but at least 50 mm.

c	concrete cover of post-installed rebar
c_1	concrete cover at end-face of existing rebar
c_{min}	minimum concrete cover according to table B5.1 and to EN 1992-1-1:2011, Section 4.4.1.2
ϕ	nominal diameter of reinforcing bar
l_0	lap length, according to EN 1992-1-1:2011 for static loading and according to EN 1998-1:2004, section 5.6.3 for seismic loading
l_v	effective embedment depth, $\geq l_0 + c_1$
d_0	nominal drill bit diameter, see Annex B6

Figures not to scale

Rebar connection with fischer injection mortar FIS EM Plus

Intended use
General construction rules for for post-installed rebars

Annex B3

Appendix 11 / 24

General construction rules for post-installed fischer rebar anchors

Figure B4.1:

- Only tension forces in the axis of the fischer rebar anchor may be transmitted.
- The tension force must be transferred via an overlap joint to the reinforcement in the building part.
- The transmission of the shear load shall be ensured by appropriate additional measures, e.g. by shear lugs or by anchors with a European Technical Assessment (ETA).
- In the anchor plate, the holes for the tension anchor shall be executed as slotted holes with the axis in the direction of the shear force.
- The length of the bonded-in thread may not be accounted as anchorage.

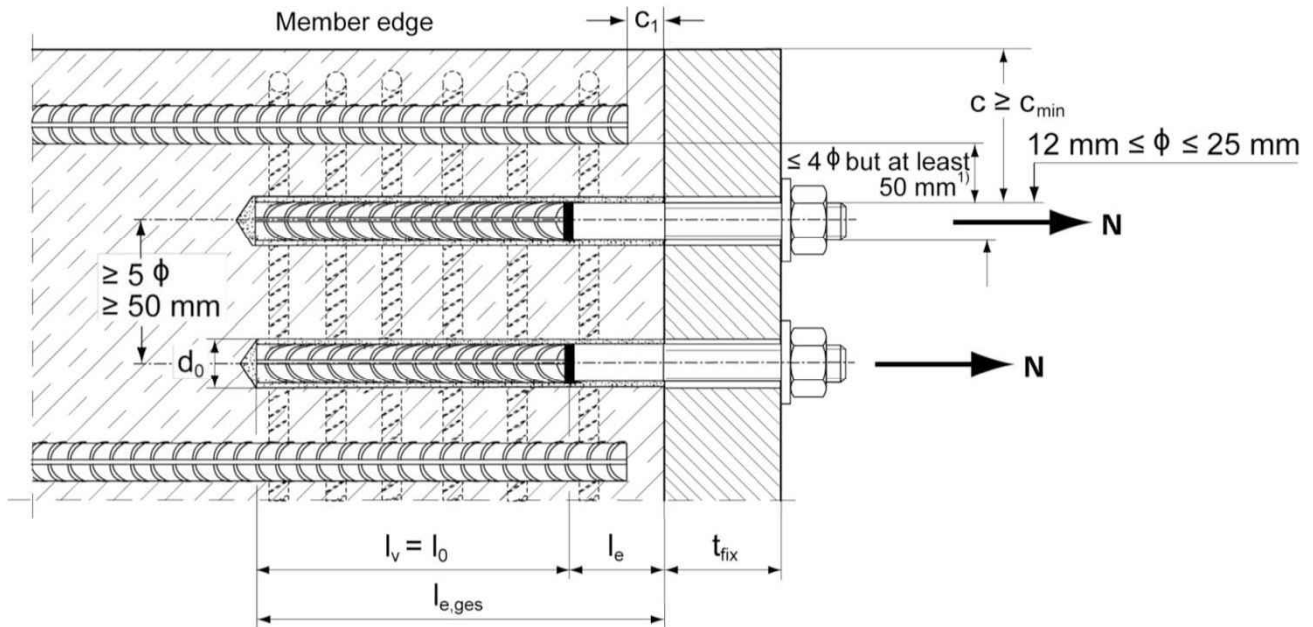

1) If the clear distance between lapped bars exceeds 4ϕ but at least 50 mm then the lap length shall be increased by the difference between the clear bar distance and 4ϕ but at least 50 mm.

c	concrete cover of post-installed fischer rebar anchor
c_1	concrete cover at end-face of existing rebar
c_{min}	minimum concrete cover according to table B5.1 and to EN 1992-1-1:2011, Section 4.4.1.2
ϕ	nominal diameter of reinforcing bar
l_0	lap length, according to EN 1992-1-1:2011, Section 8.7.3
$l_{e,ges}$	overall embedment depth, $\geq l_0 + l_e$
d_0	nominal drill bit diameter, see Annex B6
l_e	length of the bonded in threaded part
t_{fix}	thickness of the fixture
l_v	effective embedment depth

Figures not to scale

Rebar connection with fischer injection mortar FIS EM Plus

Intended use

General construction rules for post-installed fischer rebar anchors

Annex B4

Appendix 12 / 24

Table B5.1: Minimum concrete cover $c_{min} = c_{min,seis}$ ¹⁾ depending of the drilling method and the drilling tolerance

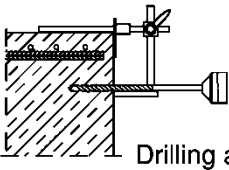
Drilling method	nominal diameter of reinforcing bar ϕ [mm]	Minimum concrete cover $c_{min} = c_{min,seis}$		 Drilling aid
		Without drilling aid [mm]	With drilling aid [mm]	
Hammer drilling with standard drill bit	< 25	30 mm + 0,06 $l_v \geq 2 \phi$	30 mm + 0,02 $l_v \geq 2 \phi$	
	≥ 25	40 mm + 0,06 $l_v \geq 2 \phi$	40 mm + 0,02 $l_v \geq 2 \phi$	
Hammer drilling with hollow drill bit (fischer "FHD", Heller "Duster Expert"; Bosch "Speed Clean"; Hilti "TE-CD, TE-YD")	< 25	30 mm + 0,06 $l_v \geq 2 \phi$	30 mm + 0,02 $l_v \geq 2 \phi$	
	≥ 25	40 mm + 0,06 $l_v \geq 2 \phi$	40 mm + 0,02 $l_v \geq 2 \phi$	
Compressed air drilling	< 25	50 mm + 0,08 l_v	50 mm + 0,02 l_v	
	≥ 25	60 mm + 0,08 $l_v \geq 2 \phi$	60 mm + 0,02 $l_v \geq 2 \phi$	
Diamond drilling	< 25	30 mm + 0,06 $l_v \geq 2 \phi$	30 mm + 0,02 $l_v \geq 2 \phi$	
	≥ 25	40 mm + 0,06 $l_v \geq 2 \phi$	40 mm + 0,02 $l_v \geq 2 \phi$	

¹⁾ See Annex B3, figure B3.1 and Annex B4, figure B4.1

Note: The minimum concrete cover as specified in EN 1992-1-1:2011 must be observed.

Table B5.2: Dispensers and cartridge sizes corresponding to maximum embedment depth $l_{v,max}$

reinforcing bars (rebar)	fischer rebar anchor	Manual dispenser	Accu and pneumatic dispenser (small)	Pneumatic dispenser (large)
		Cartridge size 300 ml, 390 ml, 585 ml	Cartridge size 300 ml, 390 ml, 585 ml	Cartridge size 1500 ml
ϕ [mm]	[-]	$l_{v,max} / l_{e,ges,max}$ [mm]	$l_{v,max} / l_{e,ges,max}$ [mm]	$l_{v,max} / l_{e,ges,max}$ [mm]
8	---	1000	1000	1800
10	---			
12	FRA M12 FRA HCR M12			
14	---			
16	FRA M16 FRA HCR M16	700	1500	2000
20	FRA M20 FRA HCR M20		1300 ¹⁾	
22 / 24 / 25	FRA M24 FRA HCR M24	500	1000 ¹⁾	2000
26 / 28	---		700 ¹⁾	
30 / 32 / 34	---		no performance assessed	
36	---			
40	---			

¹⁾ Not possible with the 300 ml cartridge

Rebar connection with fischer injection mortar FIS EM Plus

Intended use
Minimum concrete cover;
dispenser and cartridge sizes corresponding to maximum embedment depth

Annex B5
Appendix 13 / 24

Table B6.1: Working times t_{work} and curing times t_{cure}

Temperature in the anchorage base [°C]	Maximum working time ¹⁾ t_{work} FIS EM Plus	Minimum curing time ²⁾ t_{cure} FIS EM Plus
-5 to 0	240 min ³⁾	200 h
>0 to 5	150 min ³⁾	90 h
>5 to 10	120 min ³⁾	40 h
>10 to 20	30 min	18 h
>20 to 30	14 min	10 h
>30 to 40	7 min ⁴⁾	5 h

1) Maximum time from the beginning of the injection to rebar / fischer rebar anchor setting and positioning

2) For wet concrete the curing time must be doubled

3) If the temperature in the concrete falls below 10°C the cartridge has to be warmed up to +15°C.

4) If the temperature in the concrete exceeds 30 °C the cartridge has to be cooled down to +15°C up to 20°C

Table B6.2: Installation tools for drilling and cleaning the bore hole and injection of the mortar

reinforcing bars (rebar) ϕ [mm]	fischer rebar anchor [-]	Drilling and cleaning				Injection	
		Nominal drill bit diameter d_o [mm]	Diameter of cutting edge d_{cut} [mm]	Steel brush diameter d_b [mm]	Diameter of cleaning nozzle [mm]	Diameter of extension tube [mm]	Injection adapter [colour]
8 ¹⁾	---	10	$\leq 10,50$	11,0	---	9	---
10 ¹⁾	---	12	$\leq 12,50$	12,5	11		nature
		14	$\leq 14,50$	15			blue
12 ¹⁾	FRA M12 ¹⁾ FRA HCR M12 ¹⁾	14	$\leq 14,50$	15	15	red	
14	---	16	$\leq 16,50$	17		yellow	
16	FRA M16 FRA HCR M16	18	$\leq 18,50$	19	19	green	
20	FRA M20 FRA HCR M20	20	$\leq 20,55$	21,5		black	
22 / 24	---	25	$\leq 25,55$	26,5		grey	
25	FRA M24 ¹⁾ FRA HCR M24 ¹⁾	30	$\leq 30,55$	32	28	grey	
		35	$\leq 35,70$	37		brown	
26 / 28	---	35	$\leq 35,70$	37	38	brown	
30 / 32 / 34	---	40	$\leq 40,70$	42		red	
36	---	45	$\leq 45,70$	47		yellow	
40	---	55	$\leq 55,70$	58		nature	

1) Both drill bit diameters can be used

Rebar connection with fischer injection mortar FIS EM Plus

Intended use

Working times and curing times;
Installation tools for drilling and cleaning the bore hole and injection of the mortar

Annex B6

Appendix 14 / 24

Safety regulations

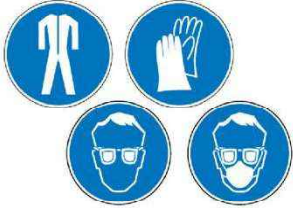

Review the Material Safety Data Sheet (SDS) before use for proper and safe handling!

Wear well-fitting protective goggles and protective gloves when working with mortar FIS EM Plus

Important: Observe the instructions for use provided with each cartridge.

Installation instruction part 1; Installation with FIS EM Plus

Hole drilling

Note: Before drilling, remove carbonized concrete; clean contact areas (see Annex B2)

In case of aborted drill holes the drill hole shall be filled with mortar.

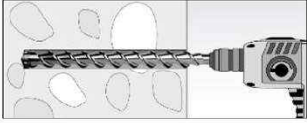
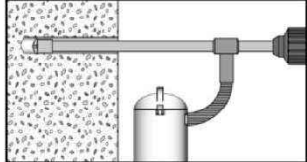
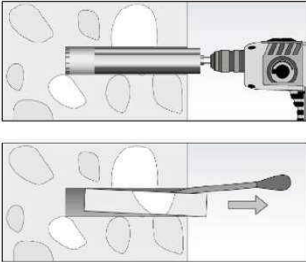
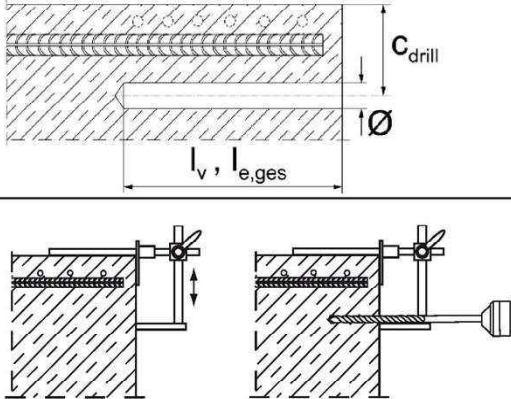
1a	<p>Hammer drilling or compressed air drilling</p> 	<p>Drill the hole to the required embedment depth using a hammer drill with carbide drill bit set in rotation hammer mode or a pneumatic drill. Drill bit sizes see table B6.2</p>
1b	<p>Hammer drilling with hollow drill bit</p> 	<p>Drill the hole to the required embedment depth using a hammer drill with hollow drill bit in rotation hammer mode. Dust extraction conditions see drill hole cleaning annex B8. Drill bit sizes see table B6.2</p>
1c	<p>Diamond drilling</p> 	<p>Drill the hole to the required embedment depth using a diamond drill in rotation mode. Drill bit sizes see table B6.2</p> <p>Break away the drill core and remove it</p>
2		<p>Measure and control concrete cover c ($C_{drill} = c + \varnothing / 2$) Drill parallel to surface edge and to existing rebar. Where applicable use fischer drilling aid.</p> <p>For holes $l_v > 20$ cm use drilling aid. Three different options can be considered:</p> <ul style="list-style-type: none"> A) fischer drilling aid B) Slat or spirit level C) Visual check <p>Minimum concrete cover c_{min} see table B5.1</p>

Rebar connection with fischer injection mortar FIS EM Plus

Intended use







Safety regulations; Installation instruction part 1, hole drilling

Annex B7

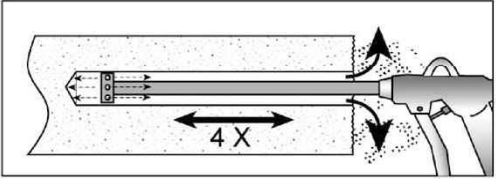
Appendix 15 / 24

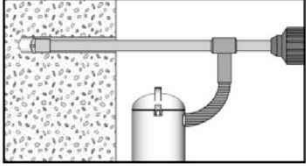
Installation instruction part 2; Installation with FIS EM Plus

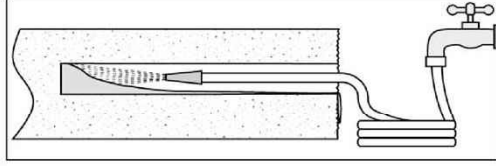
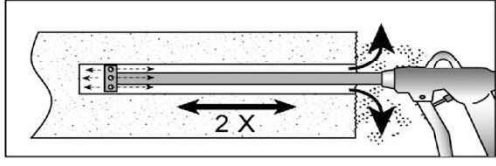
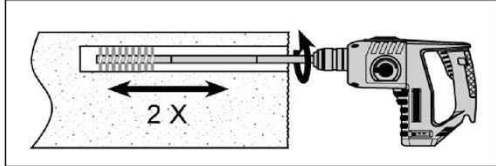
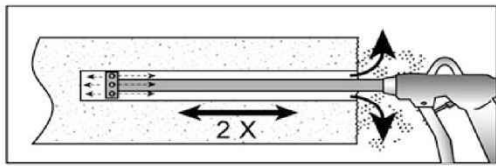
Drill hole cleaning

3a	<p>Hammer or compressed air drilling</p> 	 <p>Blowing four times from the back of the hole with the appropriate nozzle (oil-free compressed air ≥ 6 bar) until return air stream is free of noticeable dust. Personal protective equipment must be used (see regulations Annex B7).</p>
3b	<p>Hammer drilling with hollow drill bit</p> 	 <p>Use a suitable dust extraction system, e. g. fischer FVC 35 M or a comparable dust extraction system with equivalent performance data. Drill the hole with hollow drill bit. The dust extraction system has to extract the drill dust nonstop during the drilling process and must be adjusted to maximum power. No further drill hole cleaning necessary</p>
3c	<p>Diamond drilling</p>    	 <p>Flush the bore hole until the water comes clear</p> <p>Blowing twice from the back of the hole with the appropriate nozzle (oil-free compressed air ≥ 6 bar) until return air stream is free of noticeable dust. Personal protective equipment must be used (see regulations Annex B7).</p> <p>Check steel brush with brush control template. Fix an adequate steel brush with an extension into a drilling machine and brush the bore hole twice</p> <p>Blowing twice from the back of the hole with the appropriate nozzle (oil-free compressed air ≥ 6 bar) until return air stream is free of noticeable dust. Personal protective equipment must be used (see regulations Annex B7).</p>

Rebar connection with fischer injection mortar FIS EM Plus

Intended use
Installation instruction part 2, hole cleaning

Annex B8

Appendix 16 / 24

Installation instruction part 3; Installation with FIS EM Plus

reinforcing bars (rebar) / fischer rebar anchor and cartridge preparation

4

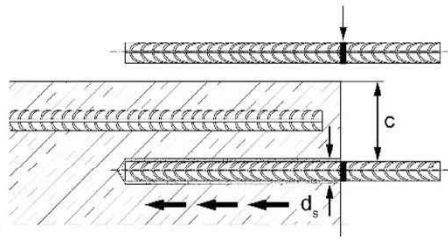

Before use, make asure that the rebar or the fischer rebar anchor is dry and free of oil or other residue.
Mark the embedment depth l_v on the rebar (e.g. with tape)
Insert rebar in borehole, to verify drill hole depth and setting depth l_v resp. $l_{e,ges}$

5

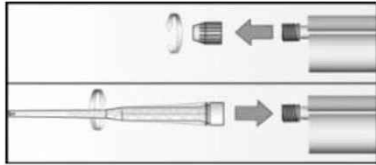

Twist off the sealing cap
Twist on the static mixer (the spiral in the static mixer must be clearly visible).

6

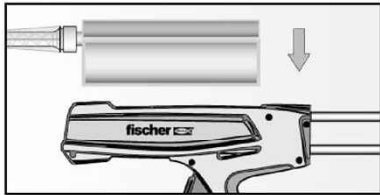

Place the cartridge into a suitable dispenser.

7

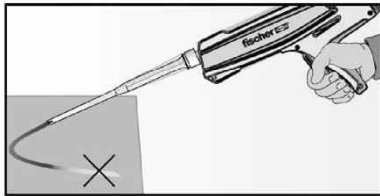

Press out approximately 10 cm of mortar until the resin is permanently grey in colour. Mortar which is not grey in colour will not cure and must be disposed.

Rebar connection with fischer injection mortar FIS EM Plus

Intended use

Installation instruction part 3,
reinforcing bars (rebar) / fischer rebar anchor and cartridge preparation

Annex B9

Appendix 17 / 24

Installation instruction part 4; Installation with FIS EM Plus

Injection of the mortar; borehole depth ≤ 250 mm

8a

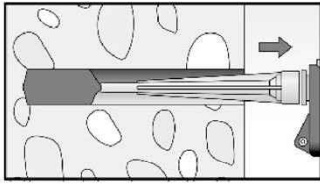

Inject the mortar from the back of the hole towards the front and slowly withdraw the mixing nozzle step by step with each trigger pull. Avoid bubbles.
Fill holes approximately 2/3 full, to ensure that the annular gap between the rebar and the concrete will be completely filled with adhesive over the entire embedment length.

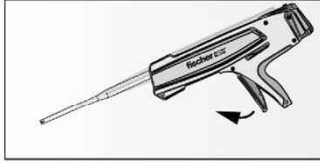

After injecting, release the dispenser. This will prevent further mortar discharge from the mixing nozzle.

Injection of the mortar; borehole depth > 250 mm

8b

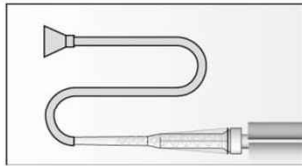

Assemble mixing nozzle FIS MR Plus or FIS UMR, extension tube and appropriate injection adapter (see table B 6.2)

Mortar level mark

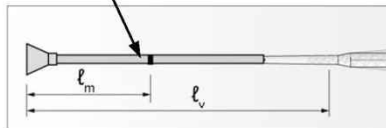

Mark the required mortar level l_m and embedment depth l_v resp. $l_{e,ges}$ with tape or marker on the injection extension tube.

a) Estimation:

$$l_m = \frac{1}{3} * l_v \text{ resp. } l_m = \frac{1}{3} * l_{e,ges} \text{ [mm]}$$

b) Precise equation for optimum mortar volume:

$$l_m = l_v \text{ resp. } l_{e,ges} \left(\left(1,2 * \frac{d_s^2}{d_0^2} - 0,2 \right) \right) \text{ [mm]}$$

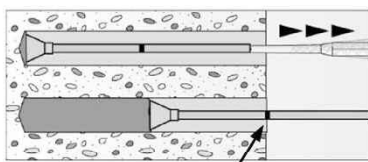

Mortar level mark

Insert injection adapter to back of the hole. Begin injection allowing the pressure of the injected adhesive mortar to push the injection adapter towards the front of the hole. Do not actively pull out!
Fill holes approximately 2/3 full, to ensure that the annular gap between the rebar and the concrete will be completely filled with adhesive over the embedment length.
When using an injection adapter continue injection until the mortar level mark l_m becomes visible.
Maximum embedment depth see table B5.2

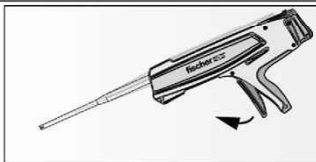

After injecting, release the dispenser. This will prevent further mortar discharge from the mixing nozzle.

Rebar connection with fischer injection mortar FIS EM Plus



Intended use
Installation instruction part 4, mortar injection

Annex B10

Appendix 18 / 24

Installation instruction part 5; Installation with FIS EM Plus

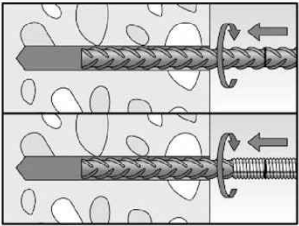
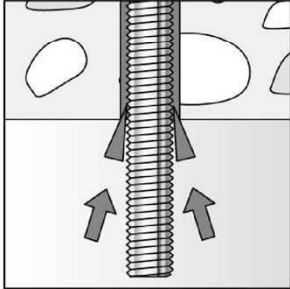
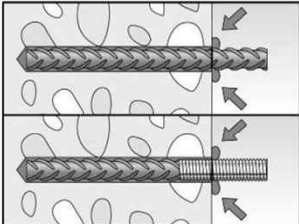
Insert rebar / fischer rebar anchor

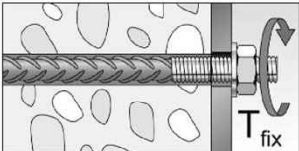
9		Insert the rebar / fischer rebar anchor slowly twisted into the borehole until the embedment mark is reached.
10		For overhead installation, support the rebar / fischer rebar anchor and secure it from falling till mortar started to harden, e.g. using wedges.
11		After installing the rebar or fischer rebar anchor the annular gap must be completely filled with mortar. Proper installation <ul style="list-style-type: none">• Desired embedment depth is reached lv: embedment mark at concrete surface.• Excess mortar flows out of the borehole after the rebar has been fully inserted up to the embedment mark.
12		Observe the working time " t_{work} " (see table B6.1), which varies according to temperature of base material. Minor adjustments to the rebar / fischer rebar anchor position may be performed during the working time Full load may be applied only after the curing time " t_{cure} " has elapsed (see table B 6.1)
13		Mounting the fixture, max T_{fix} see table A7.1

Rebar connection with fischer injection mortar FIS EM Plus

Intended use

Installation instruction part 5, insert rebar / fischer rebar anchor

Annex B11

Appendix 19 / 24

Minimum anchorage length and minimum lap length

The minimum anchorage length $l_{b,min}$ and the minimum lap length $l_{0,min}$ according to EN 1992-1-1:2011 shall be multiply by the relevant amplification factor $\alpha_{lb} = \alpha_{lb,100y}$ according to table C1.1.

Table C1.1: Amplification factor $\alpha_{lb} = \alpha_{lb,100y}$ related to concrete strength class and drilling method with a service life of 50 or 100 years

Hammer drilling, hollow drilling and compressed air drilling

Rebar / fischer rebar anchor ϕ [mm]	Amplification factor $\alpha_{lb} = \alpha_{lb,100y}$								
	Concrete strength class								
	C12/15	C16/20	C20/25	C25/30	C30/37	C35/45	C40/50	C45/55	C50/60
8 to 25	1,0								
26 to 40	1,0								

Diamond drilling

8 to 12	1,0	1,04	1,08	1,13	1,17	1,21	1,25
14 to 25	1,0	1,04	1,08	1,13	1,17	1,21	1,25
26 to 40	1,0	1,08	1,17	1,25	1,33	1,42	1,50

Table C1.2: Bond efficiency factor $k_b = k_{b,100y}$ for hammer drilling, hollow drilling and compressed air drilling with a service life of 50 or 100 years

Hammer drilling, hollow drilling and compressed air drilling

Rebar / fischer rebar anchor ϕ [mm]	Bond efficiency factor $k_b = k_{b,100y}$								
	Concrete strength class								
	C12/15	C16/20	C20/25	C25/30	C30/37	C35/45	C40/50	C45/55	C50/60
8 to 25	1,0								0,98
26 to 40	1,0								0,98

Table C1.3: Bond efficiency factor $k_b = k_{b,100y}$ for diamond drilling with a service life of 50 or 100 years

Diamond drilling

Rebar / fischer rebar anchor ϕ [mm]	Bond efficiency factor $k_b = k_{b,100y}$								
	Concrete strength class								
	C12/15	C16/20	C20/25	C25/30	C30/37	C35/45	C40/50	C45/55	C50/60
8 to 12	1,0								0,95
14 to 25	1,0								0,95
26 to 40	1,0				0,96	0,87	0,81	0,76	

Table C1.4: Characteristic values for **steel failure** under tension load of **fischer rebar anchors**

fischer rebar anchor FRA / FRA HCR	M12	M16	M20	M24
Bearing capacity under tension load, steel failure				
Characteristic resistance $N_{Rk,s}$ [kN]	63	111	173	270
Partial factor				
Partial factor $\gamma_{Ms,N}$ [-]	1,4			

Rebar connection with fischer injection mortar FIS EM Plus

Performance

Amplification factor $\alpha_{lb} = \alpha_{lb,100y}$ bond efficiency factor $k_b = k_{b,100y}$

Annex C1

Appendix 20 / 24

Table C2.1: Design values of the bond strength $f_{bd,PIR} = f_{bd,PIR,100y}$ in N/mm² for hammer drilling, hollow drilling, compressed air drilling and diamond drilling with a service life of 50 or 100 years

$$f_{bd,PIR} = k_b \cdot f_{bd}$$

$$f_{bd,PIR,100y} = k_{b,100y} \cdot f_{bd}$$

f_{bd} : Design value of the bond strength in N/mm² considering the concrete strength classes and the rebar diameter for good bond condition (for all other bond conditions multiply the values by $\eta_1 = 0,7$) and recommended partial factor $\gamma_c = 1,5$ according to EN 1992-1-1:2011

k_b Bond efficiency factor according to table C1.2 and C1.3

$k_{b,100y}$ Bond efficiency factor according to table C1.2 and C1.3

Hammer drilling, hollow drilling and compressed air drilling

Rebar / fischer rebar anchor	bond strength $f_{bd,PIR} = f_{bd,PIR,100y}$ [N/mm ²]								
	Concrete strength class								
	C12/15	C16/20	C20/25	C25/30	C30/37	C35/45	C40/50	C45/55	C50/60
ϕ [mm]									
8-32	1,6	2,0	2,3	2,7	3,0	3,4	3,7	4,0	4,2
34	1,6	2,0	2,3	2,6	2,9	3,3	3,6	3,9	4,1
36	1,5	1,9	2,2	2,6	2,9	3,3	3,6	3,8	4,0
40	1,5	1,8	2,1	2,5	2,8	3,1	3,4	3,7	3,9

Diamond drilling

Rebar / fischer rebar anchor	bond strength $f_{bd,PIR} = f_{bd,PIR,100y}$ [N/mm ²]								
	Concrete strength class								
	C12/15	C16/20	C20/25	C25/30	C30/37	C35/45	C40/50	C45/55	C50/60
ϕ [mm]									
8-12						3,4	3,7	4,0	4,1
14-25	1,6	2,0	2,3	2,7	3,0	3,4	3,7	4,0	4,1
26-32						3,2	3,2	3,2	3,2
34	1,6	2,0	2,3	2,6	2,9	3,1	3,1	3,1	3,1
36	1,5	1,9	2,2	2,6	2,9	3,1	3,1	3,1	3,1
40	1,5	1,8	2,1	2,5	2,8	2,9	2,9	2,9	2,9

Rebar connection with fischer injection mortar FIS EM Plus

Performance

Design values of the bond strength $f_{bd,PIR} = f_{bd,PIR,100y}$

Annex C2

Appendix 21 / 24

Minimum anchorage length and minimum lap length under seismic conditions

The minimum anchorage length $l_{b,min}$ and the minimum lap length $l_{o,min}$ according to EN 1992-1-1:2011 shall be multiply by the relevant amplification factor $\alpha_{lb,seis}$ according to table C3.1.

Table C3.1: Amplification factor $\alpha_{lb,seis} = \alpha_{lb,seis,100y}$ related to concrete strength class and drilling method

Hammer drilling, hollow drilling and compressed air drilling								
Rebar ϕ [mm]	Amplification factor $\alpha_{lb,seis} = \alpha_{lb,seis,100y}$							
	Concrete strength class							
	C16/20	C20/25	C25/30	C30/37	C35/45	C40/50	C45/55	C50/60
8 to 25	1,0							
26 to 40	1,0							

Table C3.2: Bond efficiency factor $k_{b,seis} = k_{b,seis,100y}$ for hammer drilling, hollow drilling and compressed air drilling with a service life of 50 or 100 years

Hammer drilling, hollow drilling and compressed air drilling								
Rebar ϕ [mm]	Bond efficiency factor $k_{b,seis} = k_{b,seis,100y}$							
	Concrete strength class							
	C16/20	C20/25	C25/30	C30/37	C35/45	C40/50	C45/55	C50/60
8 to 25	1,00							0,98
26 to 40	1,00							0,98

Table C3.3: Design values of the bond strength $f_{bd,PIR,seis} = f_{bd,PIR,seis,100y}$ in N/mm² for hammer drilling, hollow drilling and compressed air drilling **under seismic action** and for good bond conditions with a service life of 50 or 100 years

$$f_{bd,PIR,seis} = k_{b,seis} \cdot f_{bd}$$

$$f_{bd,PIR,seis,100y} = k_{b,seis,100y} \cdot f_{bd}$$

Hammer drilling, hollow drilling and compressed air drilling								
Rebar ϕ [mm]	bond strength $f_{bd,PIR,seis} = f_{bd,PIR,seis,100y}$ [N/mm ²]							
	Concrete strength class							
	C16/20	C20/25	C25/30	C30/37	C35/45	C40/50	C45/55	C50/60
8-32	2,0	2,3	2,7	3,0	3,4	3,7	4,0	4,2
34	1,6	2,0	2,3	2,6	2,9	3,3	3,6	3,9
36	1,5	1,9	2,2	2,6	2,9	3,3	3,6	3,8
40	1,5	1,8	2,1	2,5	2,8	3,1	3,4	3,7

Rebar connection with fischer injection mortar FIS EM Plus

Performance

Amplification factor $\alpha_{lb,seis} = \alpha_{lb,seis,100y}$, bond efficiency factor $k_{b,seis} = k_{b,seis,100y}$, Design values of the bond strength $f_{bd,PIR,seis} = f_{bd,PIR,seis,100y}$

Annex C3

Appendix 22 / 24

Table C4.1: Essential characteristics to **steel failure** for **fischer rebar anchors** under fire exposure

concrete strength classes C12/C15 to C50/60, according to EN 1992-4:2018

fischer rebar anchor FRA / FRA HCR				M12	M16	M20	M24
Characteristic resistance to steel failure	R30	N _{Rk,s,fi}	[kN]	1,7	2,5	4,7	7,4
	R60			1,5	2,1	3,9	6,1
	R90			1,2	1,7	3,1	4,9
	R120			0,9	1,3	2,5	3,9

Rebar connection with fischer injection mortar FIS EM Plus

Performance

Characteristic resistance to steel failure N_{Rk,s,fi} under fire exposure for fischer rebar anchor

Annex C4

Bond strength $f_{bk,fi} = f_{bk,fi,100y}$ at increased temperature for concrete strength classes C12/15 to C50/60 (all drilling methods)

The bond strength $f_{bk,fi} = f_{bk,fi,100y}$ at increased temperature has to be calculated by the following equation:

$$f_{bk,fi} = f_{bk,fi,100y} = k_{fi}(\theta) \cdot f_{bd,PIR} \cdot \frac{\gamma_c}{\gamma_{M,fi}}$$

If: $\theta > 46 \text{ }^\circ\text{C}$ $k_{fi}(\theta) = \frac{862,3 \cdot \theta^{-1,166}}{f_{bd,PIR} \cdot 4,3} \leq 1,0$

If: $\theta > \theta_{max} (284 \text{ }^\circ\text{C})$ $k_{fi}(\theta) = 0$

- $f_{bk,fi}$ = Bond strength at increased temperature in N/mm^2 for service life 50 years
- $f_{bk,fi,100y}$ = Bond strength at increased temperature in N/mm^2 for service life 100 years
- θ = Temperature in $^\circ\text{C}$ in the mortar layer
- $k_{fi}(\theta)$ = Reduction factor at increased temperature
- $= k_{fi,100y}(\theta)$
- $f_{bd,PIR}$ = Design value of the bond strength in N/mm^2 in cold condition according to table C2.1 considering the concrete classes, the rebar diameter, the drilling method and the bond conditions according to EN 1992-1-1:2011
- γ_c = 1,5 recommended partial factor according to EN 1992-1-1:2011
- $\gamma_{M,fi}$ = 1,0 recommended partial factor according to EN 1992-1-2:2011

For evidence at increased temperature the anchorage length shall be calculated according to EN 1992-1-1:2011 Equation 8.3 using the temperature-dependent ultimate bond strength $f_{bk,fi}$.

Figure C5.1: Example graph of reduction factor $k_{fi}(\theta)$ for concrete class C20/25 for good bond conditions

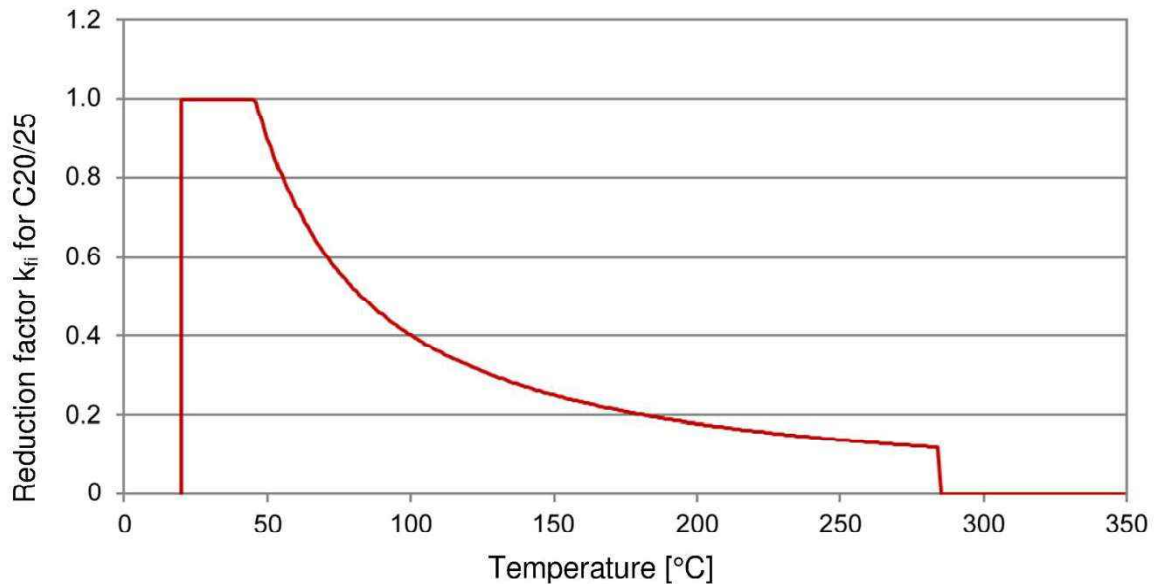

Rebar connection with fischer injection mortar FIS EM Plus

Performance

Bond strength $f_{bk,fi} = f_{bk,fi,100y}$ at increased temperature

Annex C5

Appendix 24 / 24