

DICHIARAZIONE DI PRESTAZIONE

DoP 0240

per il Sistema a iniezione fischer FIS V Zero (ancorante chimico per i collegamenti di barre di armatura post-installate)

IT

1. Codice di identificazione unico del prodotto-tipo: DoP 0240
2. Usi previsti: Sistema per il collegamento di barre di armatura post-installate con resina per l'utilizzo in calcestruzzo., Vedi appendice, in particolare gli allegati da B1 - B12.
3. Fabbricante: fischerwerke GmbH & Co. KG, Otto-Hahn-Straße 15, 79211 Denzlingen, Germany
4. Mandatario: -
5. Sistemi di VVCP: 1
6. Documento per la valutazione europea: EAD 330087-00-0601, Edition 05/2018
Valutazione tecnica europea: ETA-20/0574; 2021-05-04
Organismo di valutazione tecnica: DIBt- Deutsches Institut für Bautechnik
Organismi notificati: 2873 TU Darmstadt
7. Prestazioni dichiarate:
Resistenza meccanica e stabilità (BWR 1)
Resistenza caratteristica al carico di tensione (carico statico e quasi-statico):
Resistenza di aderenza per armature post-inserite: Allegato C2
Fattore di riduzione: Allegato C1
Fattore di amplificazione per la lunghezza di ancoraggio minima: Allegato C1

Sicurezza in caso di incendio (BWR 2)
Reazione al fuoco: Classe (A1)

Resistenza al fuoco:
Resistenza di aderenza per temperatura incrementata: Allegato C3
8. Documentazione tecnica appropriata e/o documentazione tecnica specifica: -

La prestazione del prodotto sopra identificato è conforme all'insieme delle prestazioni dichiarate. La presente dichiarazione di prestazione è emessa, in conformità al regolamento (UE) n. 305/2011, sotto la sola responsabilità del fabbricante sopra identificato.

Firmato a nome e per conto del fabbricante da:



Dr.-Ing. Oliver Geibig, Direttore Generale Unità di Business & Engineering
Tumlingen, 2021-05-11



Jürgen Grün, Direttore Generale Chimica & Qualità

Questa Dichiarazione di Prestazione (DoP) è stata preparata in varie lingue. In caso di contestazioni sull'interpretazione, prevarrà sempre la versione inglese.

L'Appendice include informazioni volontarie e complementari in lingua inglese che superano i requisiti di legge (lingua specificata in modo neutrale).

Specific Part

1 Technical description of the product

The subject of this European Technical Assessment is the post-installed connection, by anchoring or overlap connection joint, of reinforcing bars (rebars) in existing structures made of normal weight concrete, using the injection mortar fischer FIS V Zero in accordance with the regulations for reinforced concrete construction.

Reinforcing bars made of steel with a diameter ϕ from 8 to 25 mm or the fischer rebar anchor FRA or FRA HCR of sizes M12, M16, M20 and M24 and injection mortar fischer FIS V Zero are used for the rebar connection. The steel element is placed into a drilled hole filled with injection mortar and is anchored via the bond between embedded element, injection mortar and concrete.

The product description is given in Annex A.

2 Specification of the intended use in accordance with the applicable European assessment Document

The performances given in Section 3 are only valid if the anchor is used in compliance with the specifications and conditions given in Annex B.

The verifications and assessment methods on which this European Technical Assessment is based lead to the assumption of a working life of the rebar connections of at least 50 years. The indications given on the working life cannot be interpreted as a guarantee given by the producer, but are to be regarded only as a means for choosing the right products in relation to the expected economically reasonable working life of the works.

3 Performance of the product and references to the methods used for its assessment

3.1 Mechanical resistance and stability (BWR 1)

Essential characteristic	Performance
Characteristic resistance under static and quasi-static loading	See Annex C1

3.2 Safety in case of fire (BWR 2)

Essential characteristic	Performance
Reaction to fire	Class A1
Resistance to fire	See Annex C2 and C3

4 Assessment and verification of constancy of performance (AVCP) system applied, with reference to its legal base

In accordance with European Assessment Document EAD No. 330087-00-0601, the applicable European legal act is: [96/582/EC].

The system to be applied is: 1

Installation conditions and application examples reinforcing bars, part 1

Figure A1.1:

Overlap joint with existing reinforcement for rebar connections of slabs and beams

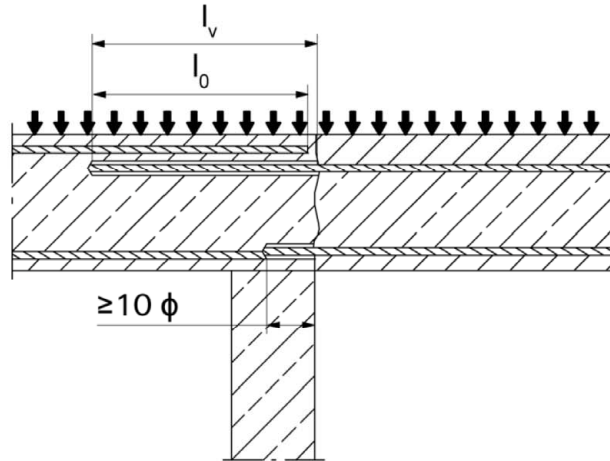

Figure A1.2:

Overlap joint with existing reinforcement at a foundation of a column or wall where the rebars are stressed

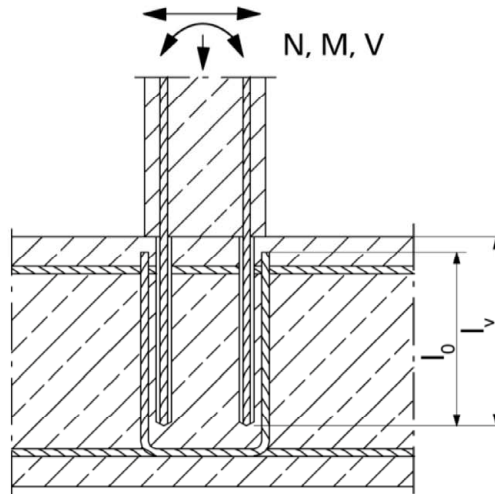
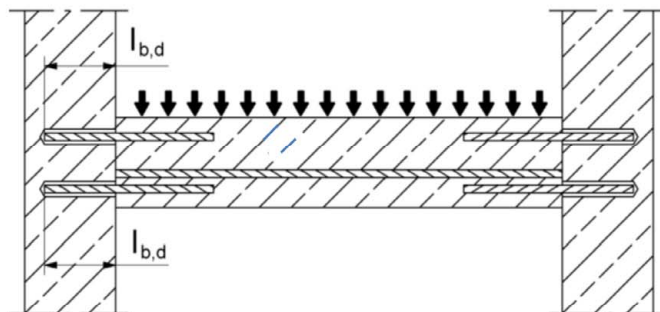

Figure A1.3:

End anchoring of slabs or beams (e.g. designed as simply supported)



Figures not to scale

Rebar connection with fischer injection system FIS V Zero

Product description

Installation conditions and application examples reinforcing bars, part 1

Annex A 1

Appendix 2 / 22

Installation conditions and application examples reinforcing bars, part 2

Figure A2.1:

Rebar connection for stressed primarily in compression

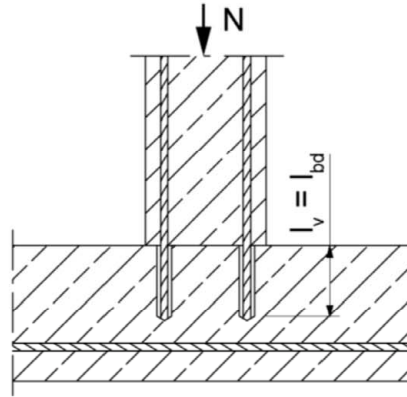
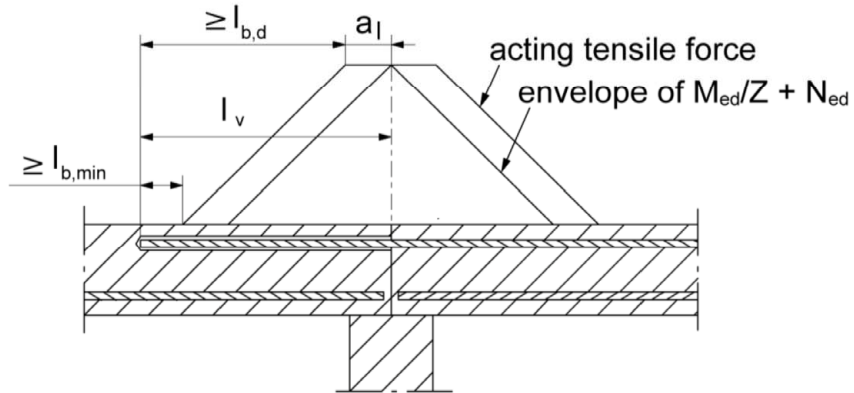

Figure A2.2:

Anchoring of reinforcement to cover the enveloped line of acting tensile force in the bending member



Note to **figure A1.1 to A1.3** and **figure A2.1 to A2.2**

In the figures no traverse reinforcement is plotted, the traverse reinforcement shall comply with EN 1992-1-1:2004+AC:2010

Preparing of joints according to **Annex B 2**

Figures not to scale

Rebar connection with fischer injection system FIS V Zero

Product description

Installation conditions and application examples reinforcing bars, part 2

Annex A 2

Appendix 3 / 22

Installation conditions and application examples fischer rebar anchor

Figure A3.1:

Lap to a foundation of a column under bending.

1. Shear lug (or fastener loaded in shear)
2. fischer rebar tension anchor (tension only)
3. Existing stirrup / reinforcement for overlap (lap splice)
4. Slotted hole

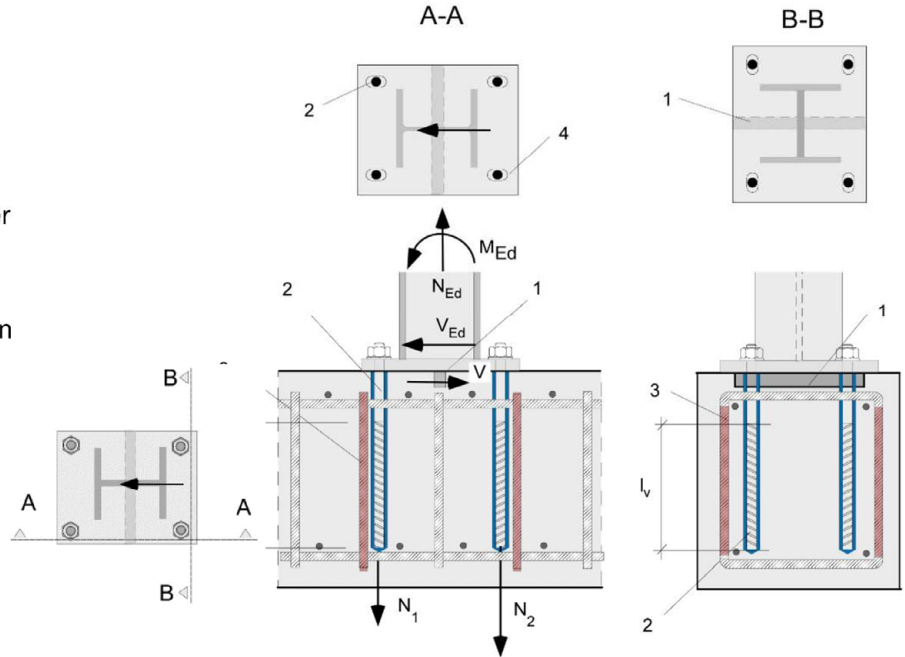
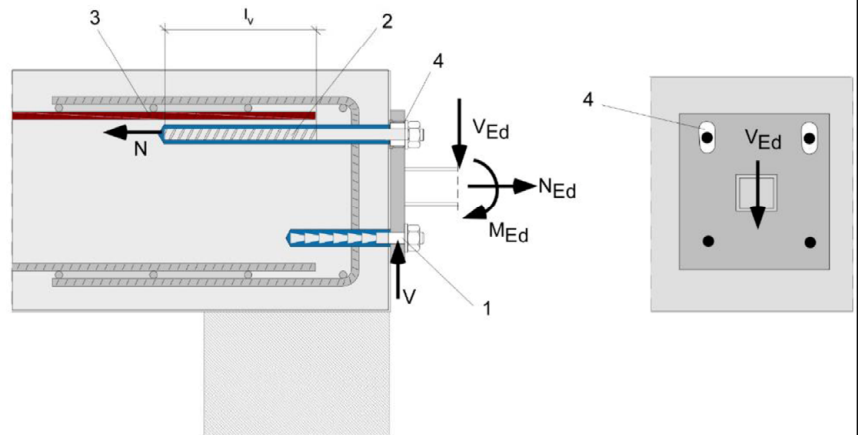

Figure A3.2:

Lap of the anchoring of guardrail posts or anchoring of cantilevered building components.

In the anchor plate, the drill holes for the fischer rebar anchors have to be designed as slotted holes with axial direction to the shear force.

1. Fastener for shear load transfer
2. fischer rebar tension anchor (tension only)
3. Existing stirrup / reinforcement for overlap (lap splice)
4. Slotted hole



The required transverse reinforcement acc. to EN 1992-1-1:2004+AC:2010 is not shown in the figures. **The fischer rebar anchor may be only used for axial tensile force.** The tensile force must be transferred by lap to the existing reinforcement of the building. The transfer of the shear force has to be ensured by suitable measures, e.g. by means of shear force or anchors with European Technical Assessment (ETA).

Figures not to scale

Rebar connection with fischer injection system FIS V Zero

Product description

Installation conditions and application examples fischer rebar anchors

Annex A 3

Appendix 4 / 22

Overview system components

Injection cartridge (shuttle cartridge) FIS V Zero with sealing cap; Sizes: 360 ml, 825 ml

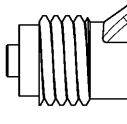
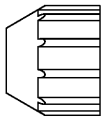

Imprint: fischer FIS V Zero, processing notes, shelf-life, curing times and processing times (depending on temperature), piston travel scale (optional), size, volume



Injection cartridge (coaxial cartridge) FIS V Zero with sealing cap; Sizes: 300 ml, 380 ml, 400 ml, 410 ml

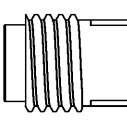
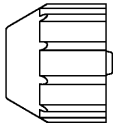

Imprint: fischer FIS V Zero, processing notes, shelf-life, curing times and processing times (depending on temperature), piston travel scale (optional), size, volume

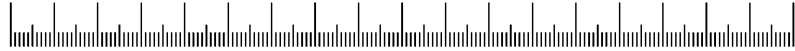

Static mixer FIS MR Plus for injection cartridges up to 410 ml

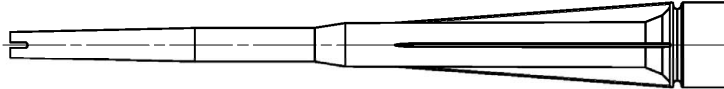

Static mixer FIS JMR for injection cartridges 825 ml

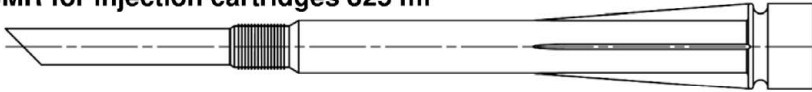

**Injection adapter and extension tube Ø 9 for static mixer FIS MR Plus;
Injection adapter and extension tube Ø 9 or Ø 15 for static mixer FIS JMR**

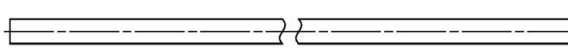
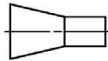

Reinforcing bar (rebar) Sizes: $\phi 8$, $\phi 10$, $\phi 12$, $\phi 14$, $\phi 16$, $\phi 20$, $\phi 22$, $\phi 24$, $\phi 25$



marking setting depth

fischer rebar anchor FRA, FRA HCR Sizes: M12, M16, M20, M24

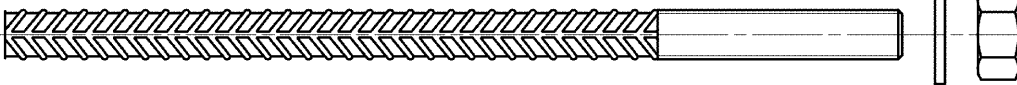

Blow out pump ABP with cleaning nozzle:

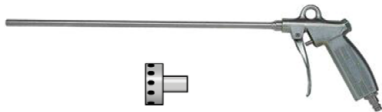

or AB G:



Figures not to scale

Rebar connection with fischer injection system FIS V Zero

Product description

Overview system components: injection mortar, static mixer, injection adapter, reinforcing bar, fischer rebar anchor, blow out pump

Annex A 4

Appendix 5 / 22

Properties of reinforcing bars (rebar)

Figure A5.1:



- The minimum value of related rip area $f_{R,min}$ according to EN 1992-1-1:2004+AC:2010
- The maximum outer rebar diameter over the ribs shall be:
 - The nominal diameter of the bar with rip $\phi + 2 * h$ ($h \leq 0,07 * \phi$)
 - (ϕ : Nominal diameter of the bar; h: rip height of the bar)

Table A5.1: Installation conditions for rebars

Nominal diameter of the bar		ϕ	8 ¹⁾		10 ¹⁾		12 ¹⁾		14	16	20	22	24	25
Nominal drill hole diameter	d_0	[mm]	10	12	12	14	14	16	18	20	25	28	30	30
Drill hole depth	h_0		$h_0 = l_v$											
Effective embedment depth	l_v		acc. to static calculation											
Minimum thickness of concrete member	h_{min}		$l_v + 30$ (≥ 100)						$l_v + 2d_0$					

¹⁾ Both drill hole diameters can be used

Table A5.2: Materials of rebars

Designation	Reinforcing bar (rebar)
Reinforcing bar EN 1992-1-1:2004+AC:2010, Annex C	Bars and de-coiled rods class B or C with f_{yk} and k according to NDP or NCL of EN 1992-1-1/NA $f_{uk} = f_{tk} = k \cdot f_{yk}$

Figures not to scale

Rebar connection with fischer injection system FIS V Zero

Product description
Properties and materials of reinforcing bars (rebar)

Annex A 5
Appendix 6 / 22

Properties of fischer rebar anchors

Figure A6.1:

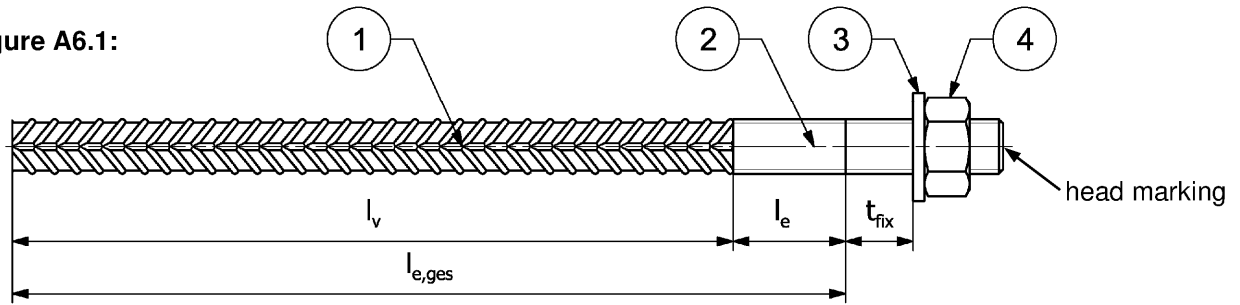

Head marking e.g.:  FRA (for stainless steel)

 FRA HCR (for high corrosion-resistant steel)

Table A6.1: Installation conditions for fischer rebar anchors

Threaded diameter		M12 ²⁾		M16	M20	M24
Nominal diameter	ϕ [mm]	12		16	20	25
Width across flat	SW [mm]	19		24	30	36
Nominal drill bit diameter	d_0 [mm]	14	16	20	25	30
Drill hole depth ($h_0 = l_{e,ges}$)	$l_{e,ges}$ [mm]	$l_v + l_e$				
Effective embedment depth	l_v [mm]	acc. to static calculation				
Distance concrete surface to welded joint	l_e [mm]	100				
Diameter of clearance hole in the fixture ¹⁾	Pre-positioned $\leq d_f$ [mm]	14		18	22	26
	Push through $\leq d_f$ [mm]	16	18	22	26	32
Minimum thickness of concrete member	h_{min} [mm]	h_0+30 (≥ 100)		$h_0 + 2d_0$		
Maximum torque moment for attachment of the fixture	$\max T_{fix}$ [Nm]	50		100	150	150

¹⁾ For bigger clearance holes in the fixture see EN 1992-4:2018

²⁾ Both drill bit diameters can be used

Table A6.2: Materials of fischer rebar anchors

Part	Description	Materials	
		FRA Corrosion resistance class CRC III acc. to EN 1993-1-4:2015	FRA HCR Corrosion resistance class CRC V acc. to EN 1993-1-4:2015
1	Reinforcing bar	Bars and de-coiled rods class B or C with f_{yk} and k according to NDP or NCL of EN 1992-1-1:NA; $f_{uk} = f_{tk} = k \cdot f_{yk}$; ($f_{yk} = 500 \text{ N/mm}^2$)	
2	Round bar with partial or full thread	Stainless steel, strength class 70 or for M 24 PC 80, according to EN 10088-1:2014	Stainless steel, strength class 70 or for M 24 PC 80, according to EN 10088-1:2014
3	Washer ISO 7089:2000	Stainless steel, according to EN 10088-1:2014	Stainless steel, according to EN 10088-1:2014
4	Hexagon nut	Stainless steel, strength class 80, acc. to EN ISO 3506-2:2009, according to EN 10088-1:2014	Stainless steel, strength class 80, acc. to EN ISO 3506-2:2009, according to EN 10088-1:2014

Figures not to scale

Rebar connection with fischer injection system FIS V Zero

Product description





Properties and materials of fischer rebar anchors

Annex A 6

Appendix 7 / 22

Specifications of intended use (part 1)

Table B1.1: Overview use and performance categories

Anchorages subject to	FIS V Zero with ...			
	Reinforcing bar 	fischer rebar anchor 		
Hammer drilling with standard drill bit or compressed air drilling 	all sizes			
Hammer drilling with hollow drill bit (fischer "FHD", Heller "Duster Expert"; Bosch „Speed Clean“; Hilti "TE-CD, TE-YD") 	Nominal drill bit diameter (d_0) 12 mm to 30 mm			
Static and quasi static load, in uncracked concrete	all sizes	Tables: C1.1 C1.2 C2.1	all sizes	Tables: C1.1 C1.2 C1.3 C2.1
Installation temperature	$T_{i,min} = -10\text{ °C}$ to $T_{i,max} = +40\text{ °C}$			
Resistance to fire	all sizes	Annex C3	all sizes	Table C2.2
Rebar connection with fischer injection system FIS V Zero				Annex B 1 Appendix 8 / 22
Intended use Specifications (part 1)				

Specifications of intended use (part 2)

Anchorage subject to:

- Static and quasi-static loads: reinforcing bar (rebar) size 8 mm to 25 mm
- Resistance to fire

Base materials:

- Compacted reinforced or unreinforced normal weight concrete without fibres according to EN 206:2013+A1:2016
- Strength classes C12/15 to C50/60 according to EN 206:2013+A1:2016
- Maximum chloride content of 0,40 % (CL 0.40) related to the cement content according to EN 206:2013+A1:2016
- Non-carbonated concrete

Note: In case of a carbonated surface of the existing concrete structure, the carbonated layer shall be removed in the area of the post-installed rebar connection with a diameter of $\phi + 60$ mm prior to the installation of the new rebar. The depth of concrete to be removed shall correspond to at least the minimum concrete cover in accordance with EN 1992-1-1 :2004+AC:2010. The foregoing may be neglected if building components are new and not carbonated and if building components are in dry conditions.

Application temperature Range:

- -40°C to +80°C (max. short term temperature +80°C and max long-term temperature +50°C).

Installation temperature:

- -10 °C to +40 °C

Use conditions (Environmental conditions) for fischer rebar anchors:

- For all conditions according to EN 1993-1-4:2015 corresponding to corrosion resistance classes to Annex A 6 table A6.2

Design:

- Anchorages are designed under the responsibility of an engineer experienced in anchorages and concrete work.
- Verifiable calculation notes and drawings are prepared taking account of the forces to be transmitted.
- Design according to EN 1992-1-1:2004+AC:2010, EN 1992-1-2:2004+AC:2008 and Annex B 3 and B 4.
- The actual position of the reinforcement in the existing structure shall be determined on the basis of the construction documentation and taken into account when designing.

Installation:

- Dry or wet concrete
- It must not be installed in water filled holes
- Hole drilling by hammer drill, hollow drill or compressed air drill mode
- Overhead installation allowed
- The installation of post-installed rebar respectively fischer rebar anchor shall be done only by suitable trained installer and under supervision on site; the conditions under which an installer may be considered as suitable trained and the conditions for Supervision on site are up to the member states in which the installation is done.
- Check the position of the existing rebars (if the position of existing rebars is not known, it shall be determined using a rebar detector suitable for this purpose as well as on the basis of the construction documentation and then marked on the building component for the overlap joint).

Rebar connection with fischer injection system FIS V Zero

Intended use
Specifications (part 2)

Annex B 2
Appendix 9 / 22

General construction rules for post-installed rebars

Figure B3.1:

- Only tension forces in the axis of the rebar may be transmitted.
- The transfer of shear forces between new concrete and existing structure shall be designed additionally according to EN 1992-1-1:2004+AC:2010.
- The joints for concreting must be roughened to at least such an extent that aggregate protrude.

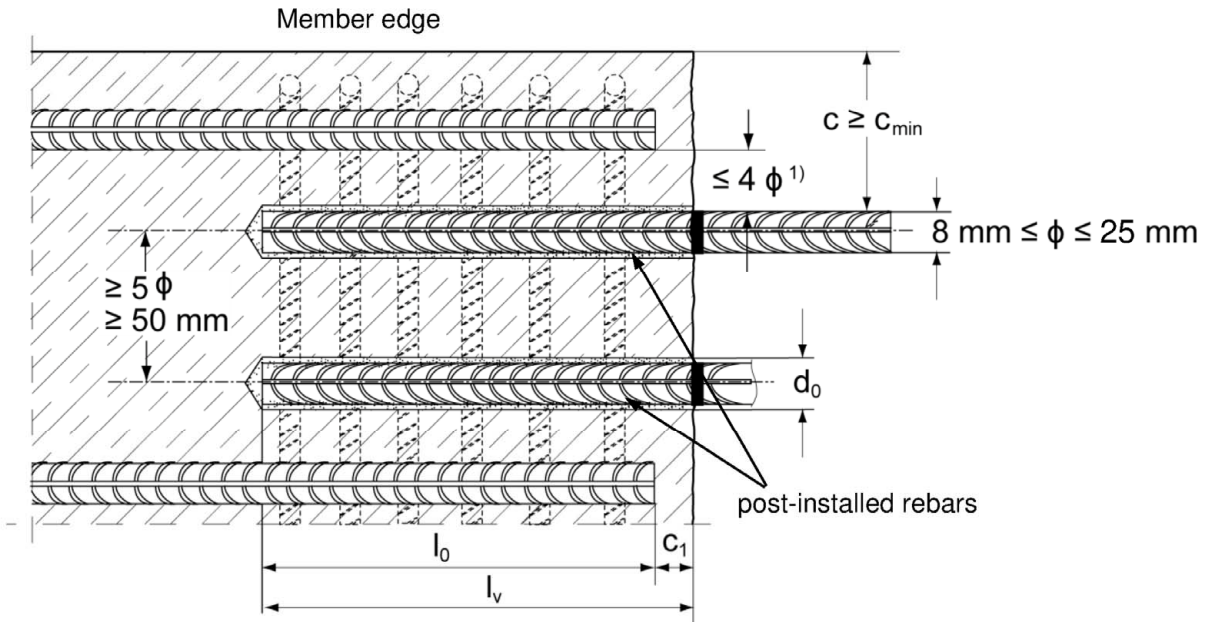

1) If the clear distance between lapped bars exceeds 4ϕ then the lap length shall be increased by the difference between the clear bar distance and 4ϕ

- c concrete cover of post-installed rebar
 c_1 concrete cover at end-face of existing rebar
 c_{min} minimum concrete cover according to table B5.1 and to EN 1992-1-1:2004+AC:2010, Section 4.4.1.2
 ϕ nominal diameter of reinforcing bar
 l_0 lap length, according to EN 1992-1-1:2004+AC:2010
 l_v effective embedment depth, $\geq l_0 + c_1$
 d_0 nominal drill bit diameter, see Annex B 6

Figures not to scale

Rebar connection with fischer injection system FIS V Zero

Intended use
 General construction rules for post-installed rebars

Annex B 3

Appendix 10 / 22

General construction rules for post-installed fischer rebar anchors

Figure B4.1:

- Only tension forces in the axis of the fischer rebar anchor may be transmitted.
- The tension force must be transferred via an overlap joint to the reinforcement in the building part.
- The transmission of the shear load shall be ensured by appropriate additional measures, e.g. by shear lugs or by anchors with a European Technical Assessment (ETA).
- In the anchor plate, the holes for the tension anchor shall be executed as slotted holes with the axis in the direction of the shear force.

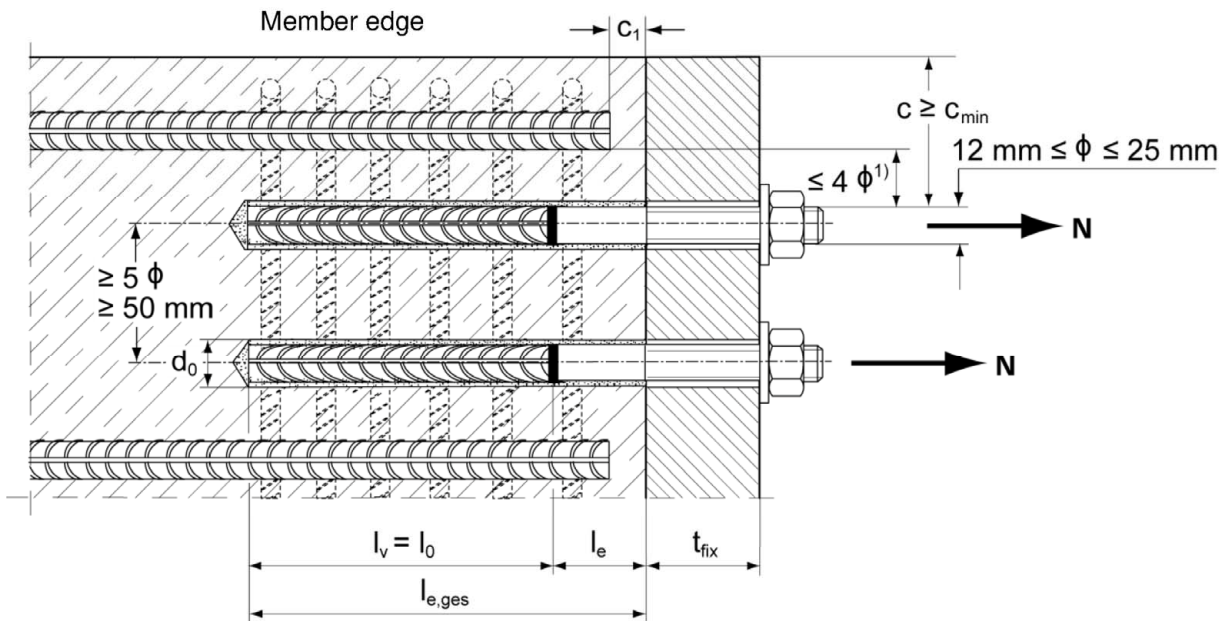

1) If the clear distance between lapped bars exceeds 4ϕ then the lap length shall be increased by the difference between the clear bar distance and 4ϕ .

c	concrete cover of post-installed fischer rebar anchor
c_1	concrete cover at end-face of existing rebar
c_{min}	minimum concrete cover according to table B5.1 and to EN 1992-1-1:2004+AC:2010, Section 4.4.1.2
ϕ	nominal diameter of reinforcing bar
l_0	lap length, according to EN 1992-1-1:2004+AC:2010, Section 8.7.3
$l_{e,ges}$	overall embedment depth, $\geq l_0 + l_e$
d_0	nominal drill bit diameter, see Annex B 6
l_e	length of the bonded in threaded part
t_{fix}	thickness of the fixture
l_v	effective embedment depth

Figures not to scale

Rebar connection with fischer injection system FIS V Zero

Intended use

General construction rules for post-installed fischer rebar anchors

Annex B 4

Appendix 11 / 22

Table B5.1: Minimum concrete cover $c_{min}^{1)}$ depending on the drilling method and the drilling tolerance

Drilling method	nominal diameter of reinforcing bar ϕ [mm]	Minimum concrete cover c_{min}	
		Without drilling aid [mm]	With drilling aid [mm]
Hammer drilling with standard drill bit or Hammer drilling with hollow drill bit (fischer "FHD", Heller "Duster Expert"; Bosch "Speed Clean"; Hilti "TE-CD, TE-YD")	< 25	30 mm + 0,06 $l_v \geq 2 \phi$	30 mm + 0,02 $l_v \geq 2 \phi$
	= 25	40 mm + 0,06 $l_v \geq 2 \phi$	40 mm + 0,02 $l_v \geq 2 \phi$
Compressed air drilling	< 25	50 mm + 0,08 l_v	50 mm + 0,02 l_v
	= 25	60 mm + 0,08 $l_v \geq 2 \phi$	60 mm + 0,02 $l_v \geq 2 \phi$

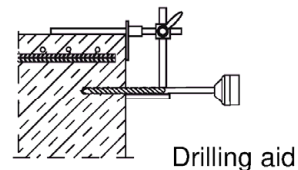

¹⁾ See Annex B 3, figure B3.1 and Annex B 4, figure B4.1

Note: The minimum concrete cover as specified in EN 1992-1-1:2004+AC:2010 must be observed.

Table B5.2: Dispensers and cartridge sizes corresponding to maximum embedment depth $l_{v,max}$ resp. $l_{e,ges,max}$

reinforcing bars (rebar)	fischer rebar anchor	Manual dispenser	Pneumatic or cordless dispenser (small)	Pneumatic or cordless dispenser (large)
		Cartridge size ≤ 500 ml (e.g. 300 ml, 360 ml, 380 ml, 400 ml, 410 ml)		Cartridge size >500 ml (e.g. 825 ml)
ϕ [mm]	[-]	$l_{v,max} / l_{e,ges,max}$ [mm]		$l_{v,max} / l_{e,ges,max}$ [mm]
8	---	700	1000	1500
10	---			
12	FRA M12 FRA HCR M12			
14	---			
16	FRA M16 FRA HCR M16			
20	FRA M20 FRA HCR M20			
22	---			
24	---			
25	FRA M24 FRA HCR M24			

Table B5.3: Conditions for use static mixer without an extension tube

Nominal drill hole diameter d_0	[mm]	10	12	14	16	18	20	22	24	25	28	30
		Drill hole depth h_0 by FIS MR Plus using FIS JMR	[mm]	-	-	-	≤ 120	≤ 140	≤ 150	≤ 160	≤ 170	≤ 190

Rebar connection with fischer injection system FIS V Zero

Intended use
Minimum concrete cover;
dispenser and cartridge sizes corresponding to maximum embedment depth

Annex B 5
Appendix 12 / 22

Table B6.1: Working times t_{work} and curing times t_{cure}

Temperature at anchoring base [°C] ³⁾	Maximum processing time ¹⁾ t_{work}	Minimum curing time ²⁾ t_{cure}
	FIS V Zero	FIS V Zero
-10 to -5	6 h	72 h
> -5 to 0	2 h	24 h
> 0 to 5	45 min	12 h
> 5 to 10	20 min	6 h
> 10 to 15	8 min	3 h
> 15 to 20	5 min	2 h
> 20 to 25	3 min	1 h
> 25 to 30	2 min	45 min
> 30 to 40	1 min	30 min

- 1) Maximum time from the beginning of the injection to rebar / fischer rebar anchor setting and positioning
2) For wet concrete the curing time must be doubled
3) If the temperature in the concrete falls below 10°C the cartridge has to be warmed up to +20°C.
If the temperature in the concrete exceeds 30°C the cartridge has to be cooled down to +20°C

Table B6.2: Installation tools for drilling and cleaning the bore hole and injection of the mortar

reinforcing bars (rebar) ϕ [mm]	fischer rebar anchor [-]	Drilling and cleaning				Injection	
		Nominal drill bit diameter d_0 [mm]	Diameter of cutting edge d_{cut} [mm]	Steel brush diameter d_b [mm]	Diameter of cleaning nozzle [mm]	extension tube 9mm Injection adapter [colour]	extension tube 15mm Injection adapter [colour]
8 ¹⁾	---	10 ²⁾	$\leq 10,50$	11	---	---	---
		12	$\leq 12,50$	14			
10 ¹⁾	---	12	$\leq 12,50$	14	11	nature	---
		14	$\leq 14,50$	16		blue	---
12 ¹⁾	FRA M12 ¹⁾ FRA HCR M12 ¹⁾	14	$\leq 14,50$	16	15	red	---
		16	$\leq 16,50$	20		yellow	---
14	---	18	$\leq 18,50$	20	19	green	green
16	FRA M16 FRA HCR M16	20	$\leq 20,55$	25		black	black
20	FRA M20 FRA HCR M20	25	$\leq 25,55$	27		blue	blue
22	---	28	$\leq 28,55$	30	28	grey	grey
24	---	30	$\leq 30,55$	40			
25	FRA M24 ¹⁾ FRA HCR M24 ¹⁾	30	$\leq 30,55$	40			

- 1) Both drill bit diameters can be used
2) Only hammer drilling with standard drill bit

Rebar connection with fischer injection system FIS V Zero

Intended use
Working times and curing times;
Installation tools for drilling and cleaning the bore hole and injection of the mortar

Annex B 6

Appendix 13 / 22

Safety regulations



Review the Safety Data Sheet (SDS) before use for proper and safe handling!
Wear well-fitting protective goggles and protective gloves when working with mortar FIS V Zero.
Important: Observe the instructions for use provided with each cartridge.

Installation instruction part 1

Hole drilling

Note: Before drilling, remove carbonated concrete; clean contact areas (see Annex B 2)
In case of aborted drill holes the drill hole shall be filled with mortar.

1 Hammer drilling or compressed air drilling

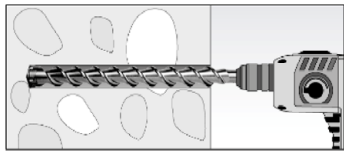

Drill the hole to the required embedment depth using a hammer drill with carbide drill bit set in rotation hammer mode or a pneumatic drill.
Drill bit sizes see **table B6.2**.

1b Hammer drilling with hollow drill bit

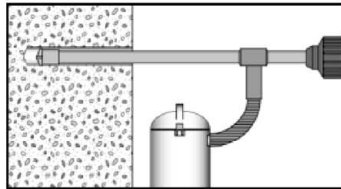

Drill the hole to the required embedment depth using a hammer drill with hollow drill bit in rotation hammer mode.
Dust extraction conditions see drill hole cleaning **annex B 8**.
Drill bit sizes see **table B6.2**

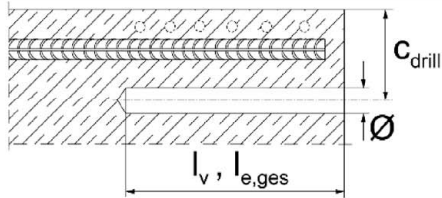

Measure and control concrete cover c
($c_{drill} = c + \varnothing / 2$)
Drill parallel to surface edge and to existing rebar.
Where applicable use fischer drilling aid.

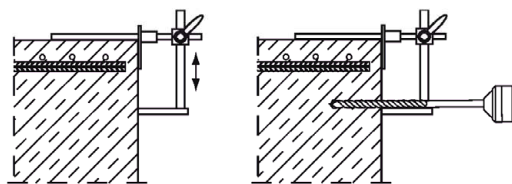

For holes $l_v > 20$ cm use drilling aid.
Three different options can be considered:
A) fischer drilling aid
B) Slat or spirit level
C) Visual check

Minimum concrete cover c_{min} see **table B5.1**

Go to step 3 or 4

Rebar connection with fischer injection system FIS V Zero

Intended use
Safety regulations; Installation instruction part 1, hole drilling

Annex B 7

Appendix 14 / 22

Installation instruction part 2

Drill hole cleaning with oil-free compressed air

Hammer or compressed air drilling

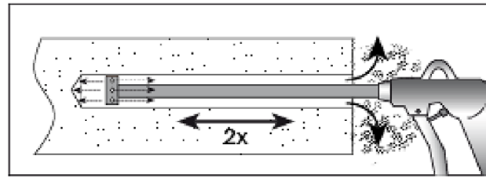

Blowing

twice from the back of the hole with the appropriate nozzle (oil-free compressed air ≥ 6 bar) until return air stream is free of noticeable dust.

Personal protective equipment must be used. (see safety regulations **Annex B 7**).

3

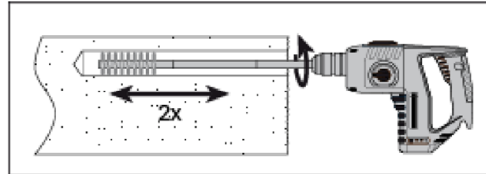

Brushing (with power drill)

Check steel brush with brush control template. The brush must produce a noticeable resistance when it is inserted into the drill hole.

Fix an adequate steel brush with an extension into a drilling machine and brush the bore hole twice.

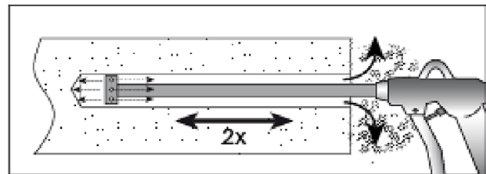

Blowing

twice from the back of the hole with the appropriate nozzle (oil-free compressed air ≥ 6 bar) until return air stream is free of noticeable dust.

Personal protective equipment must be used. (see safety regulations **Annex B 7**).

Go to step 7

Rebar connection with fischer injection system FIS V Zero

Intended use

Installation instruction part 2, drill hole cleaning

Annex B 8

Appendix 15 / 22

Installation instruction part 3

Drill hole cleaning: manual cleaning is permitted for hammer drilled boreholes up to hole diameters $d_0 < 18 \text{ mm}$ and depths l_v resp. $l_{e,ges} \leq 12 \times \phi$

4

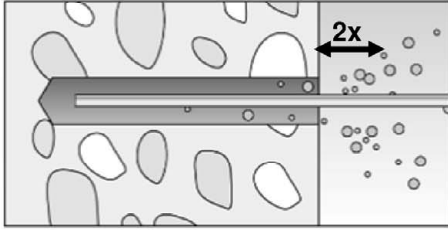

Blowing

blow out the hole twice by hand from the back of the hole. Use only the fischer blow out pump AB G. Personal protective equipment must be used (see safety regulations **Annex B 7**).

5

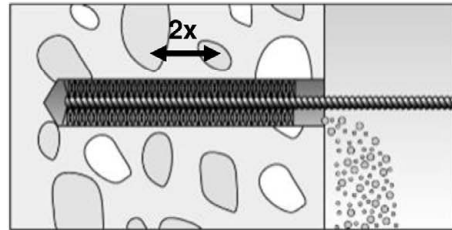

Brushing

Twice with the specified brush size by inserting the round steel brush to the back of the hole and twisting motion. The brush must produce a noticeable resistance when it is inserted into the drill hole. Corresponding brushes see **table B6.2**.

6

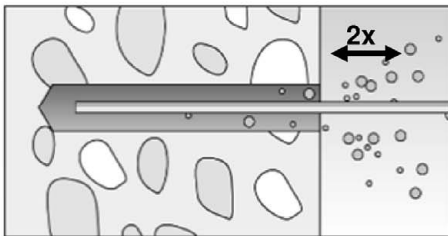

Blowing

blow out the hole twice by hand from the back of the hole. Use only the fischer blow out pump AB G. Personal protective equipment must be used. (see safety regulations **Annex B 7**).

Hammer drilling with hollow drill bit



6b

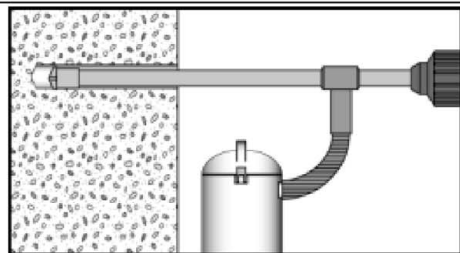

Use a suitable dust extraction system, e. g. fischer FVC 35 M or a comparable dust extraction system with equivalent performance data. Drill the hole with hollow drill bit. The dust extraction system has to extract the drill dust nonstop during the drilling process and must be adjusted to maximum power. No further drill hole cleaning necessary

Go to step 7

Rebar connection with fischer injection system FIS V Zero

Intended use

Installation instruction part 3, drill hole cleaning

Annex B 9

Appendix 16 / 22

Installation instruction part 4

reinforcing bars (rebar) / fischer rebar anchor and cartridge preparation

7

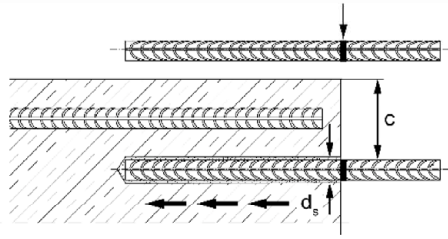

Before use, make asure that the rebar or the fischer rebar anchor is dry and free of oil or other residue. Mark the embedment depth l_v resp. $l_{e,ges}$ (e.g. with tape) Insert rebar in borehole, to verify drill hole depth and setting depth l_v resp. $l_{e,ges}$

8

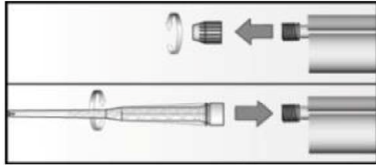

Twist off the sealing cap

Twist on the static mixer (the spiral in the static mixer must be clearly visible).

9

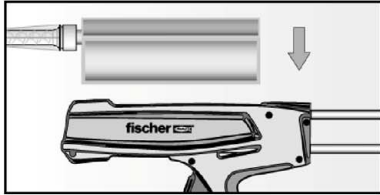

Place the cartridge into a suitable dispenser.

10

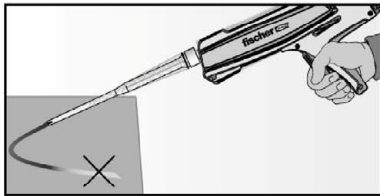

Press out approximately 10 cm of mortar until the resin is permanently grey in colour. Mortar which is not grey in colour will not cure and must be disposed.

Go to step 11

Rebar connection with fischer injection system FIS V Zero

Intended use

Installation instruction part 4,
reinforcing bars (rebar) / fischer rebar anchor and cartridge preparation

Annex B 10

Appendix 17 / 22

Installation instruction part 5; Installation with FIS V Zero

Injection of the mortar without extension tube

11a

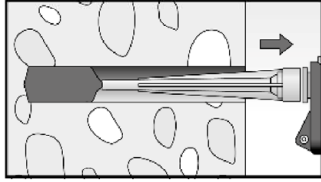

Inject the mortar from the back of the hole towards the front and slowly withdraw the mixing nozzle step by step with each trigger pull. Avoid bubbles.

Fill holes approximately 2/3 full, to ensure that the annular gap between the rebar and the concrete will be completely filled with adhesive over the entire embedment length.

The conditions for mortar injection without extension tube can be found in **table B5.3**

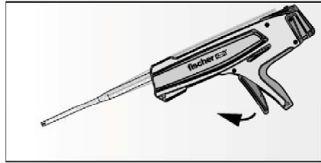

After injecting, release the dispenser. This will prevent further mortar discharge from the mixing nozzle.

Injection of the mortar with extension tube

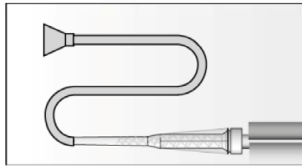

Assemble mixing nozzle FIS MR Plus or FIS JMR, extension tube and appropriate injection adapter (see **table B6.2**)

Mortar level mark

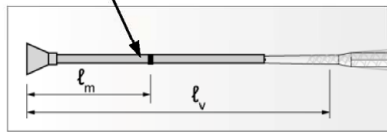

Mark the required mortar level l_m and embedment depth l_v resp. $l_{e,ges}$ with tape or marker on the injection extension tube.

a) Estimation:

$$l_m = \frac{1}{3} * l_v \text{ resp. } l_m = \frac{1}{3} * l_{e,ges}$$

b) Precise equation for optimum mortar volume:

$$l_m = l_v \text{ resp. } l_{e,ges} \left((1,2 * \frac{d_s^2}{d_0^2} - 0,2) \right) [\text{mm}]$$

11b

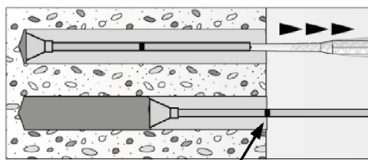

Mortar level mark

Insert injection adapter to back of the hole. Begin injection allowing the pressure of the injected adhesive mortar to push the injection adapter towards the front of the hole. Do not actively pull out!

Fill holes approximately 2/3 full, to ensure that the annular gap between the rebar and the concrete will be completely filled with adhesive over the embedment length.

When using an injection adapter continue injection until the mortar level mark l_m becomes visible.

Maximum embedment depth see **table B5.2**

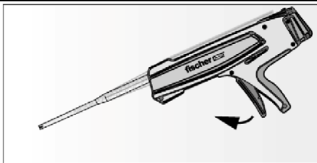

After injecting, release the dispenser. This will prevent further mortar discharge from the mixing nozzle.

Go to step 12

Rebar connection with fischer injection system FIS V Zero

Intended use

Installation instruction part 5, mortar injection

Annex B 11

Appendix 18 / 22

Installation instruction part 6; Installation with FIS V Zero

Insert rebar / fischer rebar anchor

12		<p>Insert the rebar / fischer rebar anchor slowly twisted into the borehole until the embedment mark is reached.</p> <p>Recommendation: Rotation back and forth of the reinforcement bar or the fischer rebar anchor FRA makes pushing easy</p>
13		<p>After installing the rebar or fischer rebar anchor the annular gap must be completely filled with mortar.</p> <p>Proper installation</p> <ul style="list-style-type: none"> • Desired embedment depth is reached l_v resp. $l_{e,ges}$: embedment mark at concrete surface • Excess mortar flows out of the borehole after the rebar or fischer rebar anchor have been fully inserted up to the embedment mark.
14		<p>For overhead installation, support the rebar / fischer rebar anchor and secure it from falling till mortar started to harden, e.g. using wedges.</p>
15		<p>Observe the working time "t_{work}" (see table B6.1), which varies according to temperature of base material. Minor adjustments to the rebar / fischer rebar anchor position may be performed during the working time</p> <p>Full load may be applied only after the curing time "t_{cure}" has elapsed (see table B6.1)</p>
16		<p>Mounting the fixture, max T_{fix} see table A 6.1</p>

Rebar connection with fischer injection system FIS V Zero

Intended use

Installation instruction part 6, insert rebar / fischer rebar anchor

Annex B 12

Appendix 19 / 22

Minimum anchorage length and minimum lap length

The minimum anchorage length $l_{b,min}$ and the minimum lap length $l_{o,min}$ according to EN 1992-1-1:2004+AC:2010 shall be multiplied by the relevant amplification factor α_{lb} according to **table C1.1**.

Table C1.1: Amplification factor α_{lb} related to concrete strength class and drilling method

Hammer drilling, hollow drilling and compressed air drilling

Rebar / fischer rebar anchor ϕ [mm]	Amplification factor α_{lb}								
	Concrete strength class								
	C12/15	C16/20	C20/25	C25/30	C30/37	C35/45	C40/50	C45/55	C50/60
8 to 25	1,5								

Table C1.2: Bond efficiency factor k_b for hammer drilling, hollow drilling and compressed air drilling

Hammer drilling, hollow drilling and compressed air drilling

Rebar / fischer rebar anchor ϕ [mm]	Bond efficiency factor k_b								
	Concrete strength class								
	C12/15	C16/20	C20/25	C25/30	C30/37	C35/45	C40/50	C45/55	C50/60
8	1,0	1,0	1,0	0,86	0,76	0,69	0,73	0,67	0,63
10	1,0	1,0	1,0	0,86	0,76	0,69	0,63	0,67	0,63
12	1,0	1,0	1,0	0,86	0,76	0,69	0,63	0,58	0,54
14	1,0	1,0	0,86	0,74	0,76	0,69	0,63	0,58	0,54
16	1,0	1,0	0,86	0,74	0,66	0,59	0,63	0,58	0,54
20	1,0	0,83	0,71	0,74	0,66	0,59	0,54	0,50	0,47
22	1,0	0,83	0,71	0,61	0,54	0,59	0,54	0,50	0,47
24	1,0	0,83	0,71	0,61	0,54	0,49	0,45	0,50	0,47
25	1,0	0,83	0,71	0,61	0,54	0,49	0,45	0,41	0,47

Table C1.3: Characteristic values for **steel failure** under tension load of **fischer rebar anchors**

fischer rebar anchor FRA / FRA HCR	M12	M16	M20	M24
Bearing capacity under tension load, steel failure				
Characteristic resistance $N_{Rk,s}$ [kN]	59	110	172	270
Partial factor				
Partial factor $\gamma_{Ms,N}$ [-]	1,4			

Rebar connection with fischer injection system FIS V Zero

Performance

Amplification factor α_{lb} , bond efficiency factor k_b ,
Characteristic values for steel failure under tension load of fischer rebar anchors

Annex C 1

Appendix 20 / 22

Table C2.1: Design values of the bond strength $f_{bd,PIR}$ in N/mm² for hammer drilling, hollow drilling, compressed air drilling

$$f_{bd,PIR} = k_b \cdot f_{bd}$$

f_{bd} : Design value of the bond strength in N/mm² considering the concrete strength classes and the rebar diameter for good bond condition (for all other bond conditions multiply the values by $\eta_1 = 0,7$) and recommended partial factor $\gamma_c = 1,5$ according to EN 1992-1-1: 2004+AC:2010

k_b : Bond efficiency factor according to **table C1.2**

Hammer drilling, hollow drilling and compressed air drilling

Rebar / fischer rebar anchor ϕ [mm]	bond strength $f_{bd,PIR}$ [N/mm ²]								
	Concrete strength class								
	C12/15	C16/20	C20/25	C25/30	C30/37	C35/45	C40/50	C45/55	C50/60
8	1,6	2,0	2,3	2,3	2,3	2,3	2,7	2,7	2,7
10	1,6	2,0	2,3	2,3	2,3	2,3	2,3	2,7	2,7
12	1,6	2,0	2,3	2,3	2,3	2,3	2,3	2,3	2,3
14	1,6	2,0	2,0	2,0	2,3	2,3	2,3	2,3	2,3
16	1,6	2,0	2,0	2,0	2,0	2,0	2,3	2,3	2,3
20	1,6	1,6	1,6	2,0	2,0	2,0	2,0	2,0	2,0
22	1,6	1,6	1,6	1,6	1,6	2,0	2,0	2,0	2,0
24	1,6	1,6	1,6	1,6	1,6	1,6	1,6	2,0	2,0
25	1,6	1,6	1,6	1,6	1,6	1,6	1,6	1,6	2,0

Table C2.2: Essential characteristics to **steel failure** for **fischer rebar anchors** under fire exposure R30 to R120

For concrete strength classes C12/C15 to C50/60

fischer rebar anchor FRA / FRA HCR			M12	M16	M20	M24	
Characteristic tensile resistance	R30	$N_{Rk,s,fi}$	[kN]	1,7	3,1	4,9	7,1
	R60			1,3	2,4	3,7	5,3
	R90			1,1	2,0	3,2	4,6
	R120			0,8	1,6	2,5	3,5

Rebar connection with fischer injection system FIS V Zero

Performance

Design values of the bond strength $f_{bd,PIR}$; Essential characteristics to steel failure for fischer rebar anchor $N_{Rk,s,fi}$ under fire exposure

Annex C 2

The bond strength $f_{bk,fi}$ at increased temperature for concrete strength classes C12/15 to C50/60 (all drilling methods)

The bond strength $f_{bk,fi}$ at increased temperature has to be calculated by the following equation:

$$f_{bk,fi} = k_{fi}(\theta) \cdot f_{bd,PIR} \cdot \gamma_c$$

$$\text{If: } \theta > 37 \text{ }^{\circ}\text{C} \quad k_{fi}(\theta) = \frac{13,898 \cdot e^{-0,009 \cdot \theta}}{f_{bd,PIR} \cdot 4,3} \leq 1.0$$

$$\text{If: } \theta > \theta_{\max} (347,0 \text{ }^{\circ}\text{C}) \quad k_{fi}(\theta) = 0$$

- $f_{bk,fi}$ = The bond strength at increased temperature in N/mm²
- (θ) = Temperature in °C in the mortar layer
- $k_{fi}(\theta)$ = Reduction factor at increased temperature
- $f_{bd,PIR}$ = Design value of the bond strength in N/mm² in cold condition according to table C2.1 considering the concrete classes, the rebar diameter, the drilling method and the bond conditions according to EN 1992-1-1:2004+AC:2010
- γ_c = Partial factor according to EN 1992-1-1:2004+AC:2010

For evidence at increased temperature the anchorage length shall be calculated according to EN 1992-1-1:2004+AC:2010 Equation 8.3 using the temperature-dependent ultimate bond strength $f_{bk,fi}$.

Figure C3.1: Example graph of reduction factor $k_{fi}(\theta)$ for concrete class C20/25 for good bond conditions

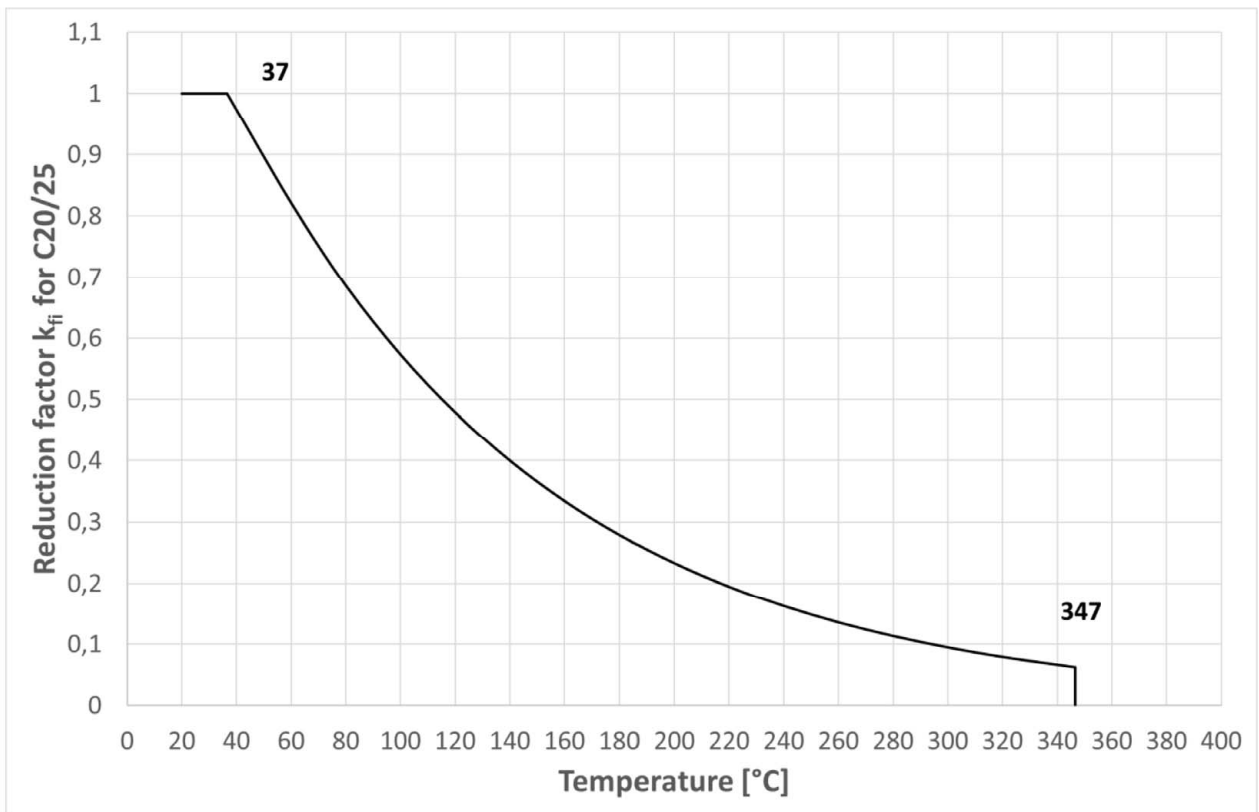

Rebar connection with fischer injection system FIS V Zero

Performance
Design values of bond strength $f_{bk,fi}$ at increased temperature

Annex C 3

Appendix 22 / 22