

DICHIARAZIONE DI PRESTAZIONE

DoP 0336

per profilo di ancoraggio fischer InnoLock FES-RS-S con bullone testa a martello per profilo di ancoraggio fischer FBC-S (profilo di ancoraggio per utilizzo in

IT

1. Codice di identificazione unico del prodotto-tipo: **DoP 0336**
2. Usi previsti: **Profilo di ancoraggio per utilizzo in calcestruzzo fessurato e non fessurato, vedi appendice, in particolare gli allegati da B1- B6.**
3. Fabbricante: **fischerwerke GmbH & Co. KG, Klaus-Fischer-Str. 1, 72178 Waldachtal, Germany**
4. Mandatario: **-**
5. Sistemi di VVCP: **1**
6. Documento per la valutazione europea: **EAD 330008-03-0601, Edition 06/2021**
Valutazione tecnica europea: **ETA-22/0035; 2022-08-01**
Organismo di valutazione tecnica: **DIBt- Deutsches Institut für Bautechnik**
Organismi notificati: **2873 TU Darmstadt**
7. Prestazioni dichiarate:
Resistenza meccanica e stabilità (BWR 1)
Resistenza caratteristica al carico di tensione (carico statico e quasi-statico):
 - 1) Resistenza alla rottura dell'acciaio dell'ancoraggio: Allegato C1
 - 2) Resistenza alla rottura dell'acciaio della connessione tra ancoraggio e canale: Allegato C1
 - 3) Resistenza alla rottura dell'acciaio per flessione locale dell'orlo del canale e conseguente estrazione del bullone testa a martello: Allegato C1
 - 4) Resistenza a rottura dell'acciaio del bullone testa a martello: Allegato C6
 - 5) Resistenza a rottura dell'acciaio per flessione del canale: Allegati A5, C1
 - 6) Massima coppia di serraggio per evitare danni durante l'installazione: Allegato B4
 - 7) Resistenza alla rottura per sfilamento: Allegato C2
 - 8) Resistenza alla rottura del cono di calcestruzzo: Allegati B3, C2
 - 9) Distanza dal bordo, interasse, spessore elemento minimo per evitare la rottura per splitting del calcestruzzo durante l'installazione: Allegati A5, B3
 - 10) Distanza dal bordo e interasse caratteristici per evitare la rottura per splitting del calcestruzzo dovuta ai carichi: Allegato C2
 - 11) Resistenza alla rottura per blow-out del calcestruzzo: Allegato A4
Resistenza caratteristica al carico di taglio (carico statico e quasi statico):
 - 12) Resistenza alla rottura dell'acciaio del bullone testa a martello sotto azione di taglio senza braccio di leva: Allegato C6
 - 13) Resistenza alla rottura dell'acciaio del bullone testa a martello per flessione sotto azione di taglio con braccio di leva: Allegato C7
 - 14) Resistenza alla rottura dell'acciaio per flessione locale dell'orlo del canale, rottura dell'acciaio della connessione tra ancoraggio e canale o rottura dell'acciaio del profilo di ancoraggio (azione di taglio in direzione trasversale): Allegati C4
 - 15) Resistenza alla rottura dell'acciaio della connessione tra gli orli del canale e il bullone testa a martello (azione di taglio in direzione longitudinale dell'asse del profilo di ancoraggio): Allegato C5
 - 16) Fattore di sensibilità all'installazione: Allegato C5
 - 17) Resistenza alla rottura dell'acciaio dell'ancoraggio: Allegato C4
 - 18) Resistenza alla rottura dell'acciaio della connessione tra ancoraggio e canale: Allegato C4
 - 19) Resistenza alla rottura per pry-out: Allegato C5
 - 20) Resistenza alla rottura del bordo di calcestruzzo: Allegato C5
Resistenza caratteristica sotto azioni statiche e quasi statiche di trazione e taglio
 - 21) Resistenza alla rottura del profilo di ancoraggio: Allegato C6
Resistenza caratteristica sotto azioni di trazione di fatica:
 - 22) Resistenza a fatica per rottura dell'acciaio dell'intero sistema (funzione continua o tri-lineare) NPD
 - 23) Resistenza limite a fatica per rottura dell'acciaio dell'intero sistema NPD
 - 24) Resistenza a fatica per rottura relativa al calcestruzzo (funzione esponenziale) NPD
 - 25) Resistenza limite a fatica per rottura relativa al calcestruzzo NPD
 - 26) Spostamenti: Allegati C3, C6
- Sicurezza in caso di incendio (BWR 2)**
 - 27) Reazione al fuoco: Classe (A1)
 - 28) Resistenza al fuoco: NPD
- Durabilità:**
 - 29) Durabilità: Allegati A7, B1



8. Documentazione tecnica appropriata e/o
documentazione tecnica specifica:

--

La prestazione del prodotto sopra identificato è conforme all'insieme delle prestazioni dichiarate. La presente dichiarazione di prestazione è emessa, in conformità al regolamento (UE) n. 305/2011, sotto la sola responsabilità del fabbricante sopra identificato.

Firmato a nome e per conto del fabbricante da:

Dr.-Ing. Oliver Geibig, Direttore Generale Unità di Business & Engineering
Tumlingen, 2023-07-25

Jürgen Grün, Direttore Generale Chimica & Qualità

Questa Dichiarazione di Prestazione (DoP) è stata preparata in varie lingue. In caso di contestazioni sull'interpretazione, prevarrà sempre la versione inglese.

L'Appendice include informazioni volontarie e complementari in lingua inglese che superano i requisiti di legge (lingua specificata in modo neutrale).

Translation guidance Essential Characteristics and Performance Parameters for Annexes

Guida alla traduzione delle Caratteristiche Essenziali e dei Parametri di Prestazione per gli Annessi

Mechanical resistance and stability (BWR 1)		
Resistenza meccanica e stabilità (BWR 1)		
Characteristic resistance to tension load (static and quasi-static loading):		
Resistenza caratteristica al carico di tensione (carico statico e quasi-statico):		
1	Resistance to steel failure of anchors: Resistenza alla rottura dell'acciaio dell'ancoraggio:	$N_{Rk,s,a}$
2	Resistance to steel failure of the connection between anchors and channel: Resistenza alla rottura dell'acciaio della connessione tra ancoraggio e canale:	$N_{Rk,s,c}$
3	Resistance to steel failure of channel lips and subsequently pullout of channel bolt: Resistenza alla rottura dell'acciaio per flessione locale dell'orlo del canale e conseguente estrazione del bullone testa a martello:	$N_{Rk,s,i}^0 ; S_{I,N}$
4	Resistance to steel failure of channel bolt: Resistenza a rottura dell'acciaio del bullone testa a martello:	$N_{Rk,s}$
5	Resistance to steel failure by exceeding the bending strength of the channel: Resistenza a rottura dell'acciaio per flessione del canale:	$M_{Rk,s,flexi} ; S_{max}$
6	Maximum installation torque moment to avoid damage during installation: Massima coppia di serraggio per evitare danni durante l'installazione:	$T_{inst,g} ; (T_{inst,s})$
7	Resistance to pull-out failure of the anchor: Resistenza alla rottura per sfilamento:	$N_{Rk,p}$
8	Resistance to concrete cone failure: Resistenza alla rottura del cono di calcestruzzo:	$k_{cr,N} ; k_{ucr,N} ; \eta_{cl}$
9	Minimum edge distance, spacing, member thickness to prevent concrete splitting during installation: Distanza dal bordo, interasse, spessore elemento minimo per evitare la rottura per splitting del calcestruzzo durante l'installazione:	$s_{min}, c_{min}, \eta_{min}$
10	Characteristic edge distance and spacing to avoid splitting of concrete under load: Distanza dal bordo e interasse caratteristici per evitare la rottura per splitting del calcestruzzo dovuta ai carichi:	$s_{cr,spi} ; c_{cr,sp}$
11	Resistance to blowout failure- bearing area of head: Resistenza alla rottura per blow-out del calcestruzzo:	A_h
Characteristic resistance to shear load (static and quasi-static loading):		
Resistenza caratteristica al carico di taglio (carico statico e quasi statico):		
12	Resistance to steel failure of channel bolt under shear loading without lever arm: Resistenza alla rottura dell'acciaio del bullone testa a martello sotto azione di taglio senza braccio di leva:	$V_{Rk,s}$
13	Resistance to steel failure by bending of the channel bolt under shear load with lever arm: Resistenza alla rottura dell'acciaio del bullone testa a martello per flessione sotto azione di taglio con braccio di leva:	$M_{Rk,s}^0$
14	Resistance to steel failure of channel lips, steel failure of connection between anchor and channel or steel failure of anchor (shear load in transverse direction): Resistenza alla rottura dell'acciaio per flessione locale dell'orlo del canale, rottura dell'acciaio della connessione tra ancoraggio e canale o rottura dell'acciaio del profilo di ancoraggio (azione di taglio in direzione trasversale):	$V_{Rk,s,Iy}^0 ; S_{I,V} ; V_{Rk,s,c,y} ; V_{Rk,s,a,y}$
15	Resistance to steel failure of connection between channel lips and channel bolt (shear load in longitudinal channel axis): Resistenza alla rottura dell'acciaio della connessione tra gli orli del canale e il bullone testa a martello (azione di taglio in direzione longitudinale dell'asse del profilo di ancoraggio):	$V_{Rk,s,I,x}$
16	Factor for sensitivity to installation: Fattore di sensibilità all'installazione:	γ_{inst}
17	Resistance to steel failure of the anchor: Resistenza alla rottura dell'acciaio dell'ancoraggio:	$V_{Rk,s,a,x}$
18	Resistance to steel failure of connection between anchor and channel: Resistenza alla rottura dell'acciaio della connessione tra ancoraggio e canale:	$V_{Rk,s,c,x}$
19	Resistance to concrete pry-out failure: Resistenza alla rottura per pry-out:	k_g
20	Resistance to concrete edge failure: Resistenza alla rottura del bordo di calcestruzzo:	$k_{cr,V} ; k_{ucr,V}$
Characteristic resistance under combined static and quasi-static tension and shear loading		
Resistenza caratteristica sotto azioni statiche e quasi statiche di trazione e taglio		
21	Resistance to steel failure of the anchor channel: Resistenza alla rottura del profilo di ancoraggio:	k_{13}, k_{14}
Characteristic resistance under fatigue tension loading:		
Resistenza caratteristica sotto azioni di trazione di fatica:		
22	Fatigue resistance to steel failure of the whole system (continuous or tri-linear function): Resistenza a fatica per rottura dell'acciaio dell'intero sistema (funzione continua o tri-lineare)	$\Delta N_{Rk,s,0,n}$ ($n=1$ to $n=\infty$)
23	Fatigue limit resistance to steel failure of the whole system: Resistenza limite a fatica per rottura dell'acciaio dell'intero sistema	$\Delta N_{Rk,s,0,\infty}$
24	Fatigue resistance to concrete related failure (exponential function): Resistenza a fatica per rottura relativa al calcestruzzo (funzione esponenziale)	$\Delta N_{Rk,c,0,n} ; \Delta N_{Rk,p,0,n}$ ($n=1$ to $n=\infty$)
25	Fatigue limit resistance to concrete related failure: Resistenza limite a fatica per rottura relativa al calcestruzzo	$\Delta N_{Rk,c,0,\infty} ; \Delta N_{Rk,p,0,\infty}$
26	Displacements: Spostamenti:	$\delta_{N0} ; \delta_{N\infty} ; \delta_{V,y,0} ; \delta_{V,y,\infty}$ $\delta_{V,x,0} ; \delta_{V,x,\infty}$
Safety in case of fire (BWR 2)		
Sicurezza in caso di incendio (BWR 2)		
27	Reaction to fire: Reazione al fuoco:	Class
28	Resistance to fire: Resistenza al fuoco:	$N_{Rk,s,fi} ; V_{Rk,s,fi}$
Durability:		
Durabilità:		
29	Durability: Durabilità:	Description

Specific Part

1 Technical description of the product

The fischer Serrated Anchor Channel InnoLock FES-RS-S with fischer Serrated Channel Bolts FBC-S is a system consisting of a C-shaped channel profile of steel and at least two metal anchors non-detachably fixed on the channel back and fischer Serrated Channel Bolts.

The anchor channel is embedded surface-flush in the concrete. fischer Serrated Channel Bolts with appropriate hexagonal nuts and washers are fixed to the channel.

The product description is given in Annex A.

2 Specification of the intended use in accordance with the applicable European Assessment Document

The performances given in Section 3 are only valid if the anchor channel is used in compliance with the specifications and conditions given in Annex B.

The verifications and assessment methods on which this European Technical Assessment is based lead to the assumption of a working life of the anchor channel of at least 50 years. The indications given on the working life cannot be interpreted as a guarantee given by the producer, but are to be regarded only as a means for choosing the right products in relation to the expected economically reasonable working life of the works.

3 Performance of the product and references to the methods used for its assessment

3.1 Mechanical resistance and stability (BWR 1)

Essential characteristic	Performance
Characteristic resistance under tension load (static and quasi-static loading)	
- Resistance to steel failure of anchors	$N_{Rk,s,a}$ see Annex C1
- Resistance to steel failure of the connection between anchors and channel	$N_{Rk,s,c}$ see Annex C1
- Resistance to steel failure of channel lips and subsequently pull-out of channel bolt	$N_{Rk,s,l}^0$; $S_{l,N}$ see Annex C1
- Resistance to steel failure of channel bolt	$N_{Rk,s}$ see Annex C6
- Resistance to steel failure by exceeding the bending strength of the channel	S_{max} see Annex A5 $M_{Rk,s,flex}$ see Annex C1
- Maximum installation torque to avoid damage during installation	$T_{inst,g}$; $T_{inst,s}$ see Annex B4
- Resistance to pull-out failure of the anchor	$N_{Rk,p}$ see Annex C2
- Resistance to concrete cone failure	h_{ef} see Annex B3 $k_{cr,N}$; $k_{ucr,N}$ see Annex C2
- Minimum edge distances, spacing and member thickness to avoid concrete splitting during installation	S_{min} see Annex A5 c_{min} ; h_{min} see Annex B3
- Characteristic edge distance and spacing to avoid splitting of concrete under load	$S_{cr,sp}$; $c_{cr,sp}$ see Annex C2
- Resistance to blowout failure - bearing area of anchor head	A_h see Annex A4

Essential characteristic	Performance
<p>Characteristic resistance under shear load (static and quasi-static loading)</p> <ul style="list-style-type: none"> - Resistance to steel failure of channel bolt under shear loading without lever arm - Resistance to steel failure by bending of the channel bolt under shear load with lever arm - Resistance to steel failure of channel lips, steel failure of connection between anchor and channel and steel failure of anchor (shear load in transverse direction) - Resistance to steel failure of connection between channel lips and channel bolt (shear load in longitudinal channel axis) - Factor for sensitivity to installation (longitudinal shear) - Resistance to steel failure of the anchor (longitudinal shear) - Resistance to steel failure of connection between anchor and channel (longitudinal shear) - Resistance to concrete pry-out failure - Resistance to concrete edge failure 	<p>$V_{Rk,s}$ see Annex C6</p> <p>$M_{Rk,s}^0$ see Annex C7</p> <p>$V_{Rk,s,l,y}^0$; $S_{l,v}$; $V_{Rk,s,c,y}$; $V_{Rk,s,a,y}$ see Annex C4</p> <p>$V_{Rk,s,l,x}$ see Annex C5</p> <p>γ_{inst} see Annex C5</p> <p>$V_{Rk,s,a,x}$ see Annex C4</p> <p>$V_{Rk,s,c,x}$ see Annex C4</p> <p>k_8 see Annex C5</p> <p>$k_{cr,v}$; $k_{ucr,v}$ see Annex C5</p>
<p>Characteristic resistance under combined tension and shear load (static and quasi-static load)</p> <ul style="list-style-type: none"> - Resistance to steel failure of the anchor channel 	<p>k_{13} ; k_{14} see Annex C6</p>
<p>Characteristic resistance under fatigue tension loading</p> <ul style="list-style-type: none"> - Fatigue resistance to steel failure of the whole system (continuous or tri-linear function, test method A1, A2) - Fatigue limit resistance to steel failure of the whole system (test method B) - Fatigue resistance to concrete related failure (exponential function, test method A1, A2) - Fatigue limit resistance to concrete related failure (test method B) 	<p>No Performance assessed</p> <p>No Performance assessed</p> <p>No Performance assessed</p> <p>No Performance assessed</p>
<p>Displacements (static and quasi-static load)</p>	<p>δ_{N0} ; $\delta_{N\infty}$ see Annex C3</p> <p>$\delta_{v,y,0}$; $\delta_{v,y,\infty}$; $\delta_{v,x,0}$; $\delta_{v,x,\infty}$ see Annex C6</p>

3.2 Safety in case of fire (BWR 2)

Essential characteristic	Performance
Reaction to fire	Class A1
Characteristic resistance to fire	No performance assessed

3.3 Aspects of durability linked with the Basic Works Requirements

Essential characteristic	Performance
Durability	See Annex B1

4 Assessment and verification of constancy of performance (AVCP) system applied, with reference to its legal base

In accordance with EAD No. 330008-03-0601, the applicable European legal act is: [2000/273/EC].

The system to be applied is: 1

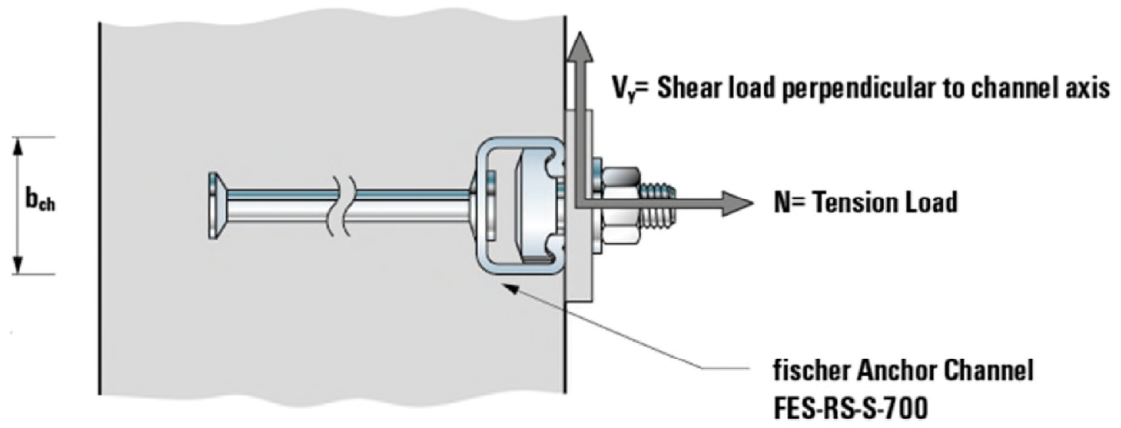
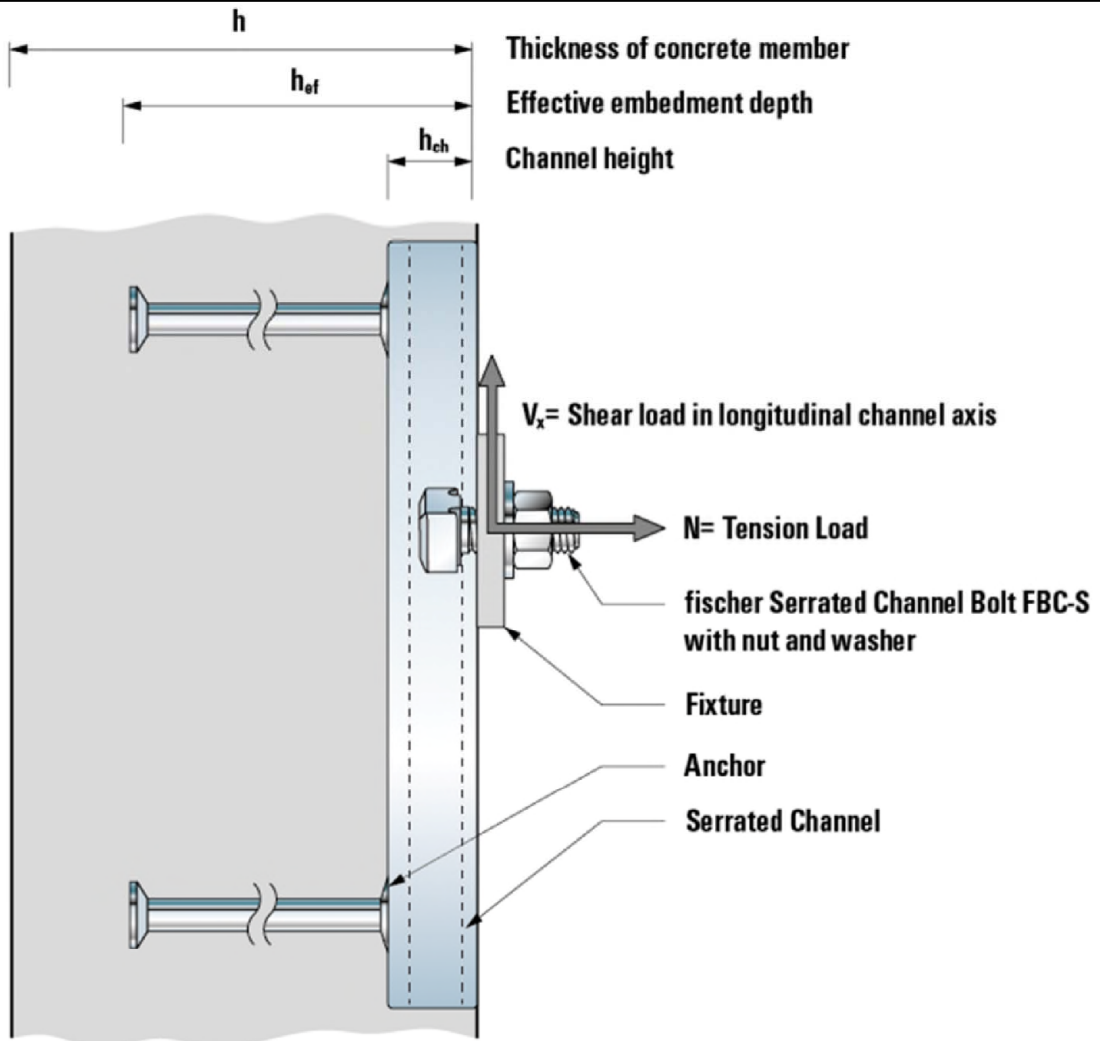

fischer Serrated Anchor Channel InnoLock FES-RS-S with fischer Serrated Channel Bolts FBC-S

Product Description
Installed conditions

Annex A1
Appendix 4 / 23

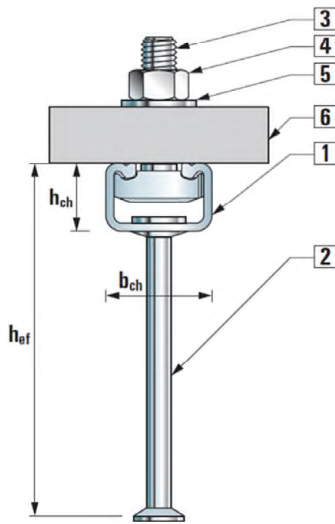

Round anchor

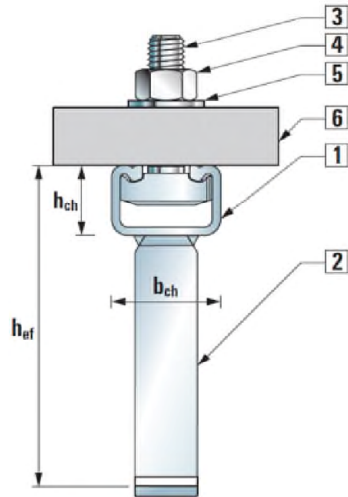

I-anchor

- fischer Anchor Channel
FES-RS-S
- 1 Serrated channel profile
 - 2 Anchor
 - 3 Serrated channel bolt
 - 4 Hexagonal nut
 - 5 Washer
 - 6 Fixture

Marking of the fischer anchor channel FES-RS-S:

e. g.:  700

 = Identifying mark of the manufacturer

I = Additional marking for I-anchors
No marking for round anchors

Marking of the fischer channel bolt FBC-S:

e. g.:  8.8 225

 = Identifying mark of the manufacturer

8.8 = Strength grade

225 = Width of anchor channel opening d_{ch}

* = Coating electro-plated
No marking for hot dip galvanized

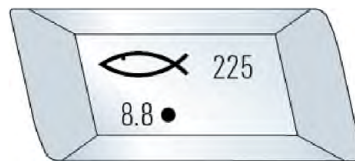
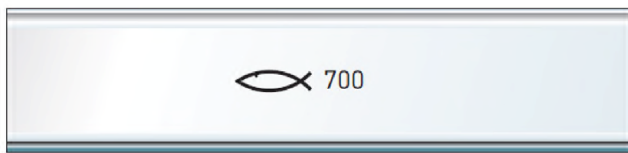

Stamped into back of channel
Optional: printed on channel web or channel lips
RS = Roll-shaped, S = Serrated
No marking for material acc. A7 Table 6 (Channel profile)

fischer Serrated Anchor Channel InnoLock FES-RS-S with fischer Serrated Channel Bolts FBC-S

Product Description
Product and marking

Annex A2
Appendix 5 / 23

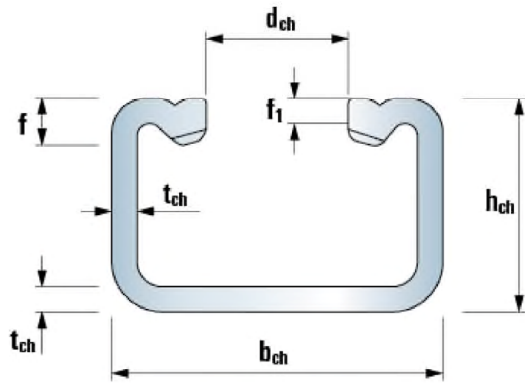

Serrated FES-RS-S-(I)-700

Table 1: Dimensions of channel profile

Anchor Channel FES-RS-S-(I)-	b_{ch} [mm]	h_{ch} [mm]	t_{ch} [mm]	d_{ch} [mm]	f [mm]	f_1 [mm]	I_y [mm ⁴]
700	52,5	34,0	4,0	22,5	7,0	4,0	79168

fischer Serrated Anchor Channel InnoLock FES-RS-S with fischer Serrated Channel Bolts FBC-S

Product Description
Dimensions of channels

Annex A3
Appendix 6 / 23

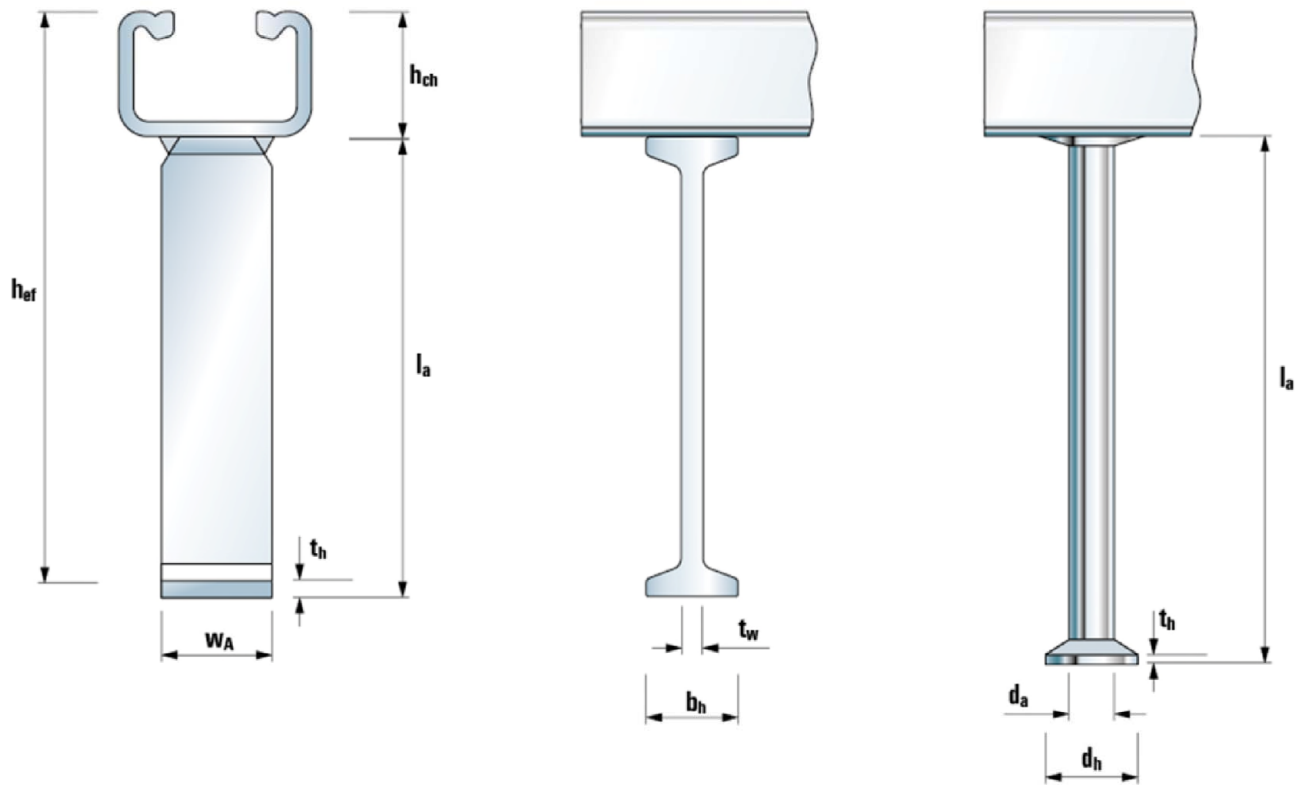

Table 2: Dimensions of anchor (welded I-anchor or forged round anchor)

Anchor Channel FES-RS-S-(I)-	I-anchor						Round anchor					
	$l_{a,min}$ [mm]	$t_{w,min}$ [mm]	$b_{h,min}$ [mm]	t_h [mm]	$W_{A,min}$ [mm]	$A_{h,min}$ [mm ²]	$l_{a,min}$ [mm]	d_a [mm]	d_h [mm]	t_h [mm]	A_h [mm ²]	
700	125	6	25	5	30	570	144	12,8	26,0	3,0	402	

fischer Serrated Anchor Channel InnoLock FES-RS-S with fischer Serrated Channel Bolts FBC-S

Product Description
Dimensions of anchors

Annex A4
Appendix 7 / 23

Table 3: Anchor position

Anchor channel FES-RS-S-(I-)	Anchor type	S _{min} [mm]	S _{max} [mm]	X _{min} [mm]	X _{max} [mm]	l _{min} [mm]	l _{max} [mm]
700	round or I	100	250	30	35	160	6.070

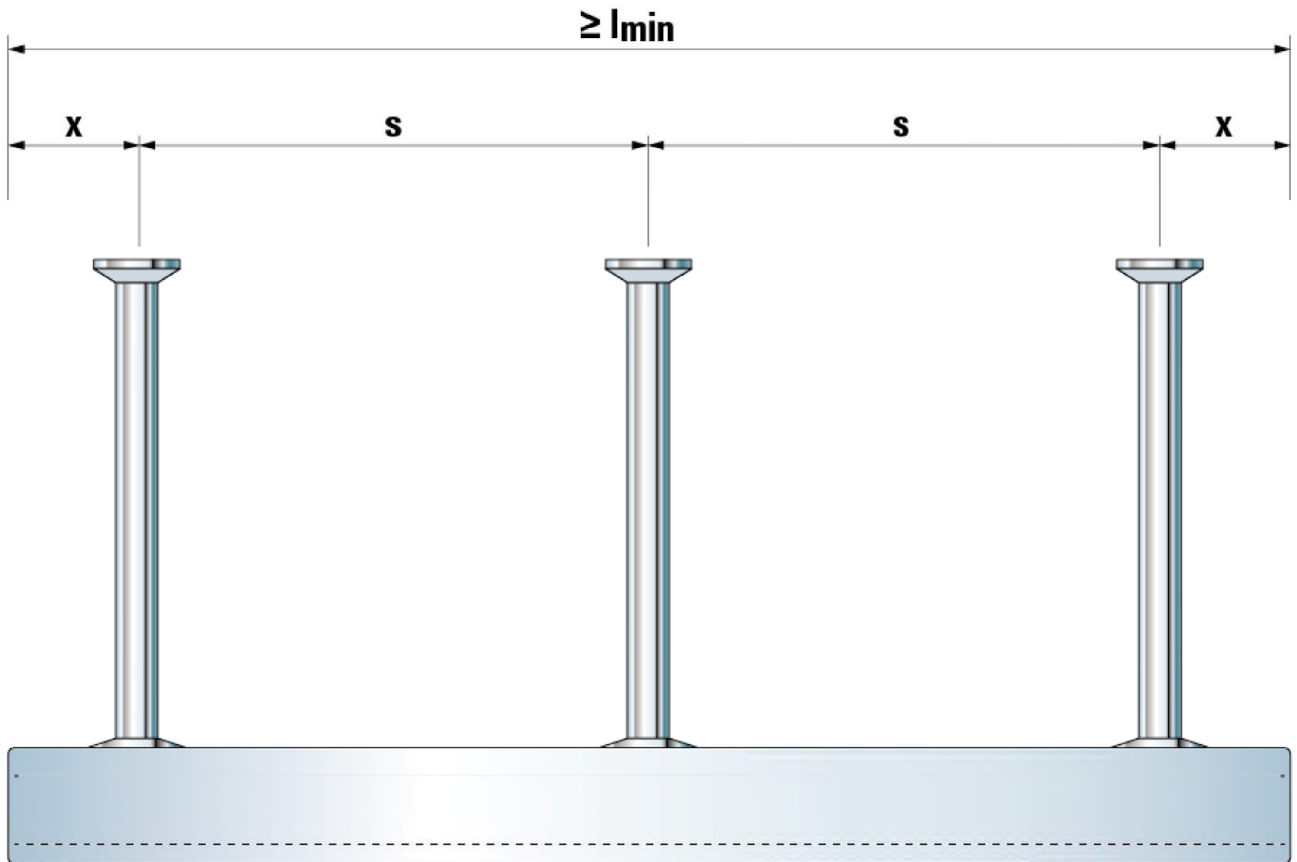

fischer Serrated Anchor Channel InnoLock FES-RS-S with fischer Serrated Channel Bolts FBC-S

Product Description

Anchor position and channel length

Annex A5

Appendix 8 / 23

Table 4: Strength grade and corrosion class

Channel Bolt	Carbon steel ¹⁾
Strength grade	8.8
f_{uk} [N/mm ²]	800 / 830
f_{yk} [N/mm ²]	640 / 660 ²⁾
Corrosion protection	F ³⁾ or Electroplated

¹⁾ Material properties according to Annex A7

²⁾ Material properties according to EN ISO 898-1: 2013

³⁾ Hot-dip galvanized

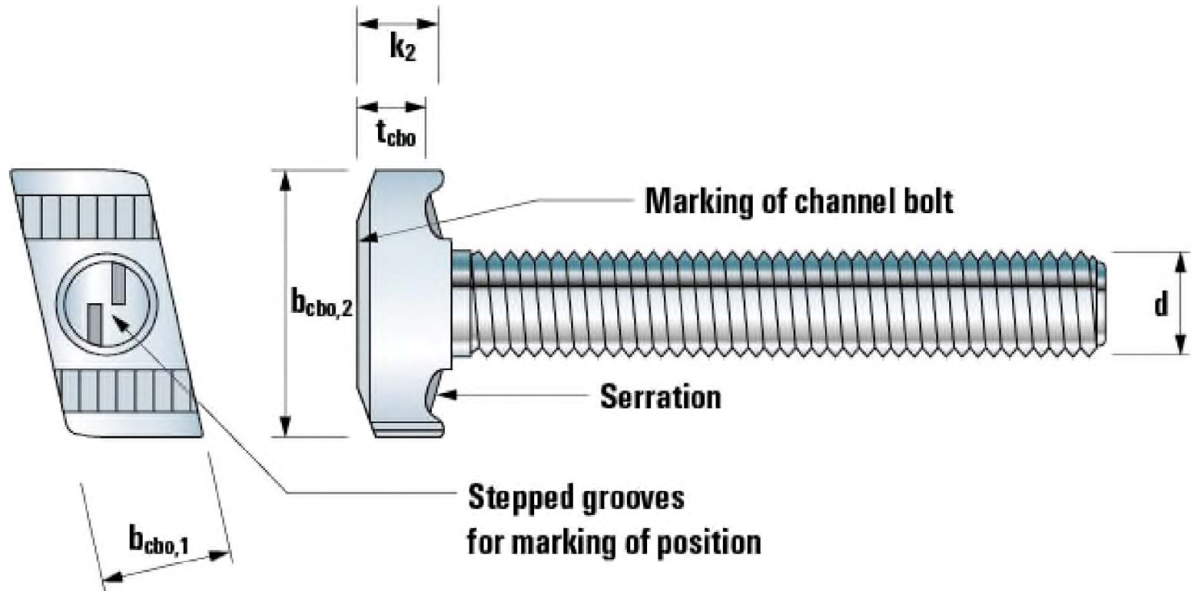

Serrated Channel Bolt FBC-S-225

Table 5: Dimensions of fischer Channel Bolts FBC and matching fischer Anchor Channels FES

Anchor Channel FES-RS-S-(I)-	Channel Bolt FBC-S-	Dimensions				
		d [mm]	$b_{cbo,1}$ [mm]	$b_{cbo,2}$ [mm]	t_{cbo} [mm]	k_2 [mm]
700	225	12	21,0	43,0	10,7	15,0
		16				
		20				

fischer Serrated Anchor Channel InnoLock FES-RS-S with fischer Serrated Channel Bolts FBC-S

Product Description
Channel bolts

Annex A6
Appendix 9 / 23

Table 6: Materials and properties

Component	Carbon steel		
	Mechanical properties	Coating	Coating
1	2	2a	2b
Channel profile	1.0976 acc. to EN 10149:2004	Hot dip galvanized ≥ 50 µm acc. to EN ISO 10684:2004 + AC:2009	Hot dip galvanized ≥ 50 µm acc. to EN ISO 10684:2004 + AC:2009
Round anchor	1.5525 acc. to EN 10263:2017	Hot dip galvanized ≥ 50 µm acc. to EN ISO 10684:2004 + AC:2009	Hot dip galvanized ≥ 50 µm acc. to EN ISO 10684:2004 + AC:2009
I-anchor	1.0976 acc. to EN 10149:2004	Hot dip galvanized ≥ 50 µm acc. to EN ISO 10684:2004 + AC:2009	Hot dip galvanized ≥ 50 µm acc. to EN ISO 10684:2004 + AC:2009
Channel bolt	Strength grade 8.8 acc. to EN ISO 898-1:2013	Electroplated acc. to EN ISO 4042:2018	Hot dip galvanized ≥ 50 µm acc. to EN ISO 10684:2004 + AC:2009
Plain washer ¹⁾ acc. to EN ISO 7089:2000 and EN ISO 7093- 1:2000	Hardness class A ≥ 200 HV	Electroplated acc. to EN ISO 4042:2018	Hot dip galvanized ≥ 50 µm acc. to EN ISO 10684:2004 + AC:2009
Hexagonal nut acc. to EN ISO 4032:2012	Property class 8 acc. to EN ISO 898-2:2012	Electroplated acc. to EN ISO 4042:2018	Hot dip galvanized ≥ 50 µm acc. to EN ISO 10684:2004 + AC:2009

¹⁾ Not in the scope of delivery

fischer Serrated Anchor Channel InnoLock FES-RS-S with fischer Serrated Channel Bolts FBC-S

Product Description
Materials

Annex A7
Appendix 10 / 23

Specification for intended use

Anchor channels and channel bolts subject to:

- Static and quasi-static tension, shear perpendicular to the longitudinal axis of the channel and shear in the direction of the longitudinal axis of the channel

Base materials:

- Reinforced or unreinforced normal weight concrete according to EN 206-1:2000.
- Strength classes C12/15 to C90/105 according to EN 206-1:2000
- Cracked or uncracked concrete.

Use conditions (Environmental conditions):

- Structures subject to dry internal conditions (anchor channels and channel bolts according to Annex A7, Table 6, column 2a and 2b).
- Structures subject to internal conditions with usual humidity (e.g. kitchens, bathrooms and laundries in residential buildings, exceptional permanent damp conditions and application under water) (anchor channels and channel bolts according to Annex A7, Table 6, column 2b).

Design:

- Anchor channels are designed under the responsibility of an engineer experienced in anchorages and concrete work.
- Verifiable calculation notes and drawings are prepared taking account of the loads to be anchored. The position of the anchor channel and channel bolts are indicated on the design drawings (e.g. position of the anchor channel relative to the reinforcement or to supports).
- For static and quasi-static loading as well as fire exposure the anchor channels have to be designed in accordance with EOTA TR 047 "Design of Anchor Channels", March 2018 or EN 1992-4:2018.
- The characteristic resistances are calculated with the minimum effective embedment depth.

fischer Serrated Anchor Channel InnoLock FES-RS-S with fischer Serrated Channel Bolts FBC-S

Intended Use
Specifications

Annex B1

Appendix 11 / 23

Installation:

- The installation of anchor channels is carried out by appropriately qualified personnel under the supervision of the person responsible for the technical matters on site.
- Use of the anchor channels only as supplied by the manufacturer - without any manipulations, repositioning or exchanging of channel components.
- Cutting of anchor channels is allowed only if pieces according to Annex A5, Table 3 are generated including end spacing x and minimum channel length l_{min} and only to be used in dry internal conditions.
- Installation in accordance with the installation instruction given in Annexes B5 and B6.
- The anchor channels are fixed on the formwork, reinforcement or auxiliary construction such that no movement of the channels will occur during the time of laying the reinforcement and of placing and compacting the concrete.
- The concrete around the head of the anchors is properly compacted. The channels are protected from penetration of concrete into the internal space of the channels.
- Washers may be chosen according to Annex A7 and provided separately by the user.
- Orientating the channel bolt (groove according to Annex B6, B7 and B8) rectangular to the channel axis.
- The required installation torque given in Annex B4 must be applied and must not be exceeded.

fischer Serrated Anchor Channel InnoLock FES-RS-S with fischer Serrated Channel Bolts FBC-S

Intended Use
Specification

Annex B2

Appendix 12 / 23

Table 7: Installation parameters

Anchor Channel FES-RS-S-			700	I-700
Minimum effective embedment depth	$h_{ef,min}$	[mm]	175	154
Minimum edge distance	c_{min}		75	75
Minimum thickness of concrete member	h_{min}		178	178

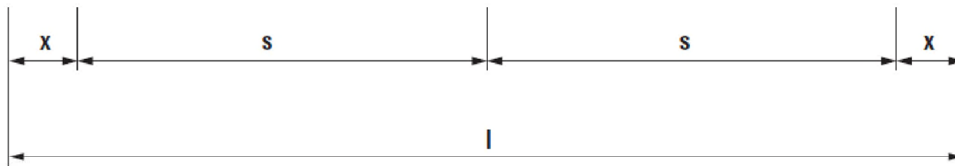
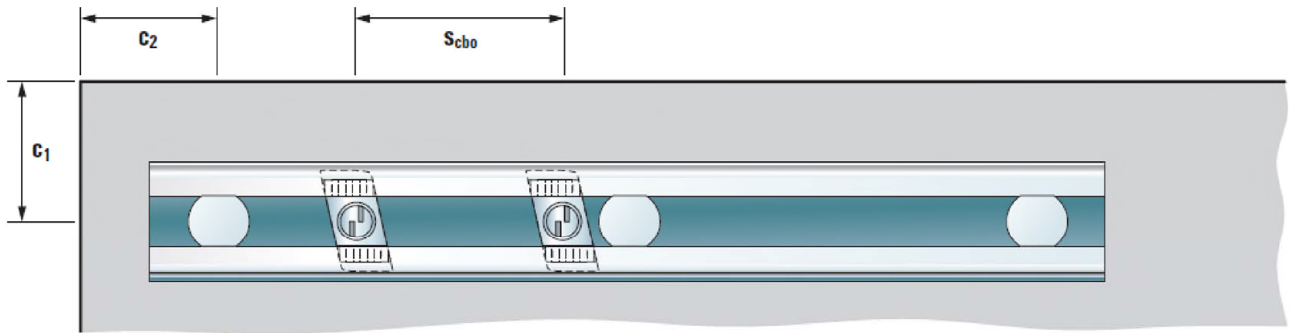

Table 8: Minimum spacing for channel bolts

Channel bolt			M12	M16	M20
Minimum spacing between channel bolts	$s_{cbo,min}$	[mm]	60	80	100

fischer Serrated Anchor Channel InnoLock FES-RS-S with fischer Serrated Channel Bolts FBC-S

Intended Use

Installation parameters for fischer Anchor Channels FES

Annex B3
Appendix 13 / 23

Table 9: Installation torque T_{inst}

fischer Anchor channel FES-RS-S-(I)-	fischer Channel Bolt FBC-S-	Thread diameter	$T_{inst}^{1)}$ [Nm]	
			General $T_{inst,g}$	Steel - steel contact $T_{inst,s}$
			8.8	8.8
700	225	M12	80	100
		M16	100	200
		M20	120	360

¹⁾ T_{inst} must not be exceeded

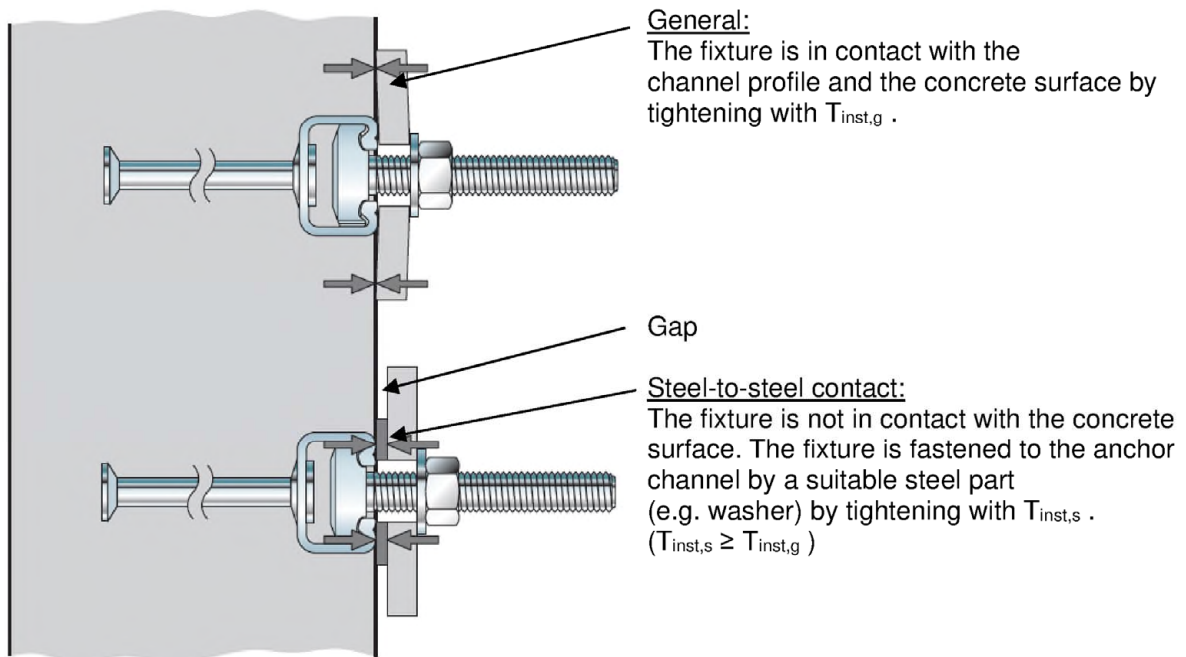

fischer Serrated Anchor Channel InnoLock FES-RS-S with fischer Serrated Channel Bolts FBC-S

Intended Use

Installation parameters for fischer Channel Bolts FBC

Annex B4

Appendix 14 / 23

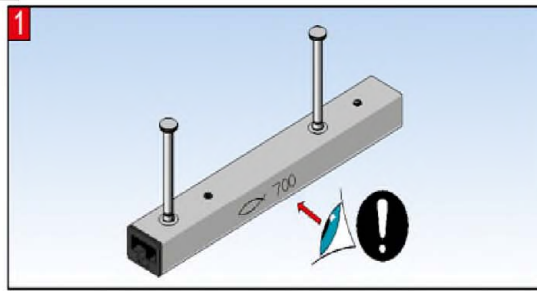

2

X	T
30-35mm	FES-RS-S
	700

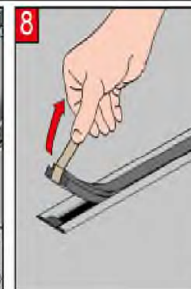
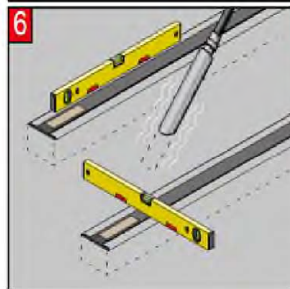
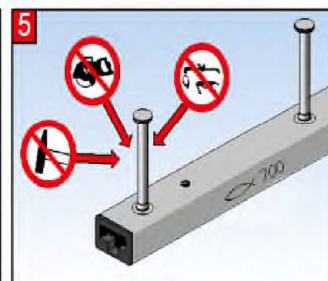
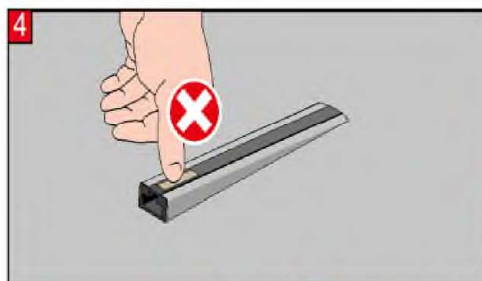
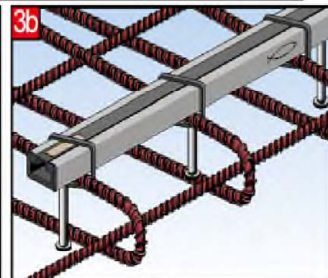
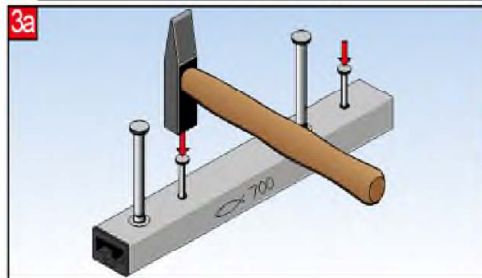

fischer Serrated Anchor Channel InnoLock FES-RS-S with fischer Serrated Channel Bolts FBC-S

Intended Use
Installation instruction for fischer Anchor Channels FES

Annex B5
Appendix 15 / 23

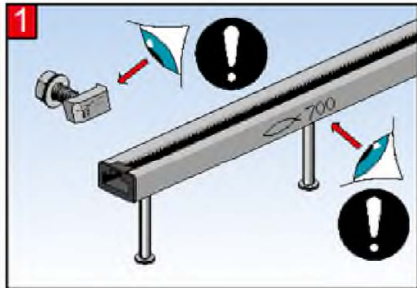

↓		T	
FBC-S-	FES-RS-S		
225	700		

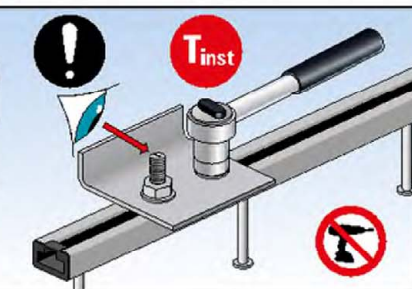
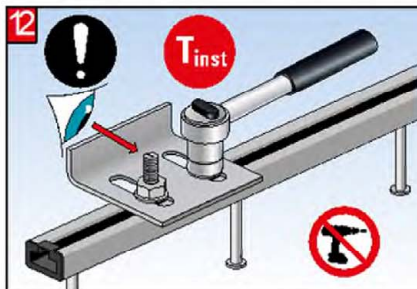
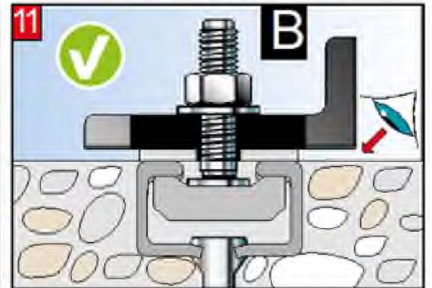
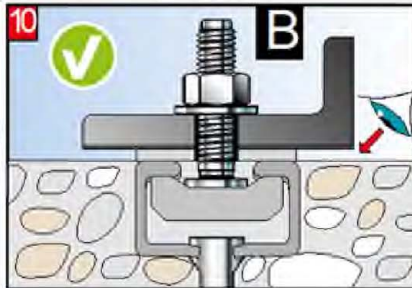
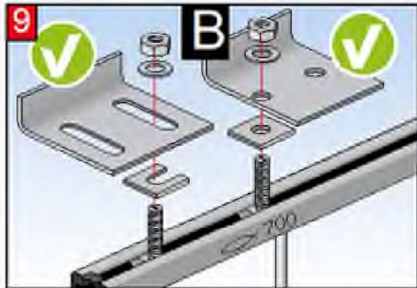
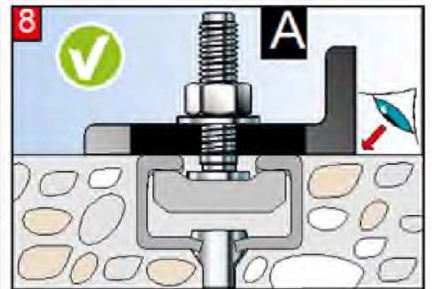
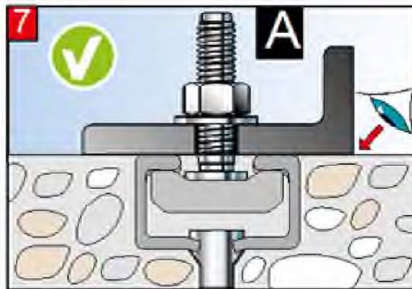
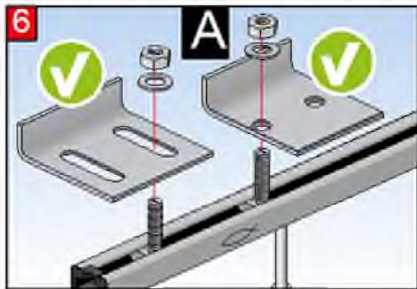
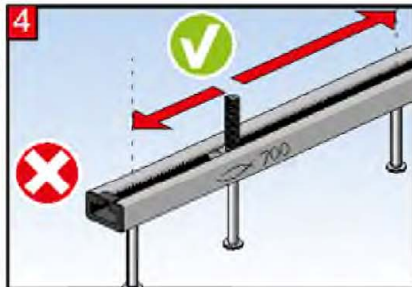
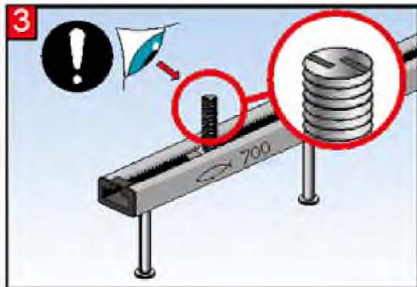
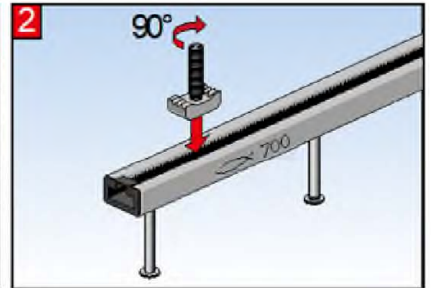

FBC-S-	FES-RS-S-	T _{inst} [Nm]	M12	M16	M20
225	700	A	80	100	120
		B	100	200	360

T_{inst} must not be exceeded.

fischer Serrated Anchor Channel InnoLock FES-RS-S with fischer Serrated Channel Bolts FBC-S

Intended Use

Installation instruction for Serrated fischer Channel Bolts FBC-S

Annex B6

Appendix 16 / 23

Table 10: Characteristic resistances under tension load – steel failure of anchor channels

Anchor Channel FES-RS-S-			700	I-700
Steel failure: Anchor				
Characteristic resistance	$N_{Rk,s,a}$	[kN]	73,3	81,0
Partial factor	$\gamma_{Ms}^{1)}$	[-]	1,8	
Steel failure: Connection between anchor and channel				
Characteristic resistance	$N_{Rk,s,c}$	[kN]	73,0	80,0
Partial factor	$\gamma_{Ms}^{1)}$	[-]	1,8	
Steel failure: Local flexure of channel lips				
Characteristic spacing of channel bolts for $N_{Rk,s,l}$	$S_{l,N}$	[mm]	105	
Characteristic resistance	$N_{Rk,s,l}^0$	[kN]	80	
Partial factor	$\gamma_{Ms}^{1)}$	[-]	1,8	

¹⁾In absence of other national regulations

Table 11: Characteristic flexural resistance of channel

Anchor Channel FES-RS-S-(I)-			700
Steel failure: Flexure of channel			
Characteristic flexural resistance of channel	$M_{Rk,s,flex}$	[Nm]	3749
Partial factor	$\gamma_{Ms,flex}^{1)}$	[-]	1,15

¹⁾In absence of other national regulations

fischer Serrated Anchor Channel InnoLock FES-RS-S with fischer Serrated Channel Bolts FBC-S

Annex C1

Performance

Characteristic resistances of anchor channels under tension load – Steel failure of anchor channel

Appendix 17 / 23

Table 12: Characteristic resistances under tension load – concrete failure

Anchor Channel FES-RS-S-			700	I-700
Concrete failure: Pull-out failure				
Characteristic resistance in cracked concrete C12/15	$N_{Rk,p}$	[kN]	36,2	51,3
Characteristic resistance in uncracked concrete C12/15	$N_{Rk,p}$	[kN]	50,7	71,8
Increasing factor of $N_{Rk,p} = N_{Rk,p}(C12/15) * \psi_c$	C16/20 C20/25 C25/30 C30/37 C35/45 C40/50 C45/55 C50/60 C55/67 $\geq C60/75$	ψ_c [-]	1,33 1,67 2,08 2,50 2,92 3,33 3,75 4,17 4,58 5,00	
Partial factor	$\gamma_{Mp} = \gamma_{Mc}^{1)}$	[-]	1,5	
Concrete failure: Concrete cone failure				
Product factor k_1	$k_{cr,N}$	[-]	8,9	8,7
	$k_{ucr,N}$	[-]	12,6	12,5
Partial factor	$\gamma_{Mc}^{1)}$	[-]	1,5	
Concrete failure: Concrete splitting failure				
Characteristic edge distance	$c_{cr,sp}$	[mm]	525	477
Characteristic spacing	$s_{cr,sp}$	[mm]	1050	954
Partial factor	$\gamma_{Msp} = \gamma_{Mc}^{1)}$	[-]	1,5	

¹⁾ In absence of other national regulations

fischer Serrated Anchor Channel InnoLock FES-RS-S with fischer Serrated Channel Bolts FBC-S

Performance
Characteristic resistances under tension load – concrete failure

Annex C2

Appendix 18 / 23

Table 13: Displacements under tension load

Anchor Channel FES-RS-S-(I)-			700
Tension load	N	[kN]	31,7
Short-term displacement ¹⁾	δ_{N0}	[mm]	2,1
Long-term displacement ¹⁾	$\delta_{N\infty}$	[mm]	4,2

¹⁾ Displacements in midspan of the anchor channel, including slip of channel bolt, deformation of channel lips, bending of the channel and slip of the anchor channel in concrete

fischer Serrated Anchor Channel InnoLock FES-RS-S with fischer Serrated Channel Bolts FBC-S

Performance
Displacement under tension load

Annex C3
Appendix 19 / 23

Table 14: Characteristic resistances under shear load – steel failure of anchor channels

Anchor Channel FES-RS-S-			700	I-700
Steel failure: Anchor				
Characteristic resistance	$V_{Rk,s,a,y}$	[kN]	120,0	120,0
	$V_{Rk,s,a,x}$	[kN]	44,0	48,6
Partial factor	$\gamma_{Ms}^{1)}$	[-]	1,8	
Steel failure of connection between anchor and channel				
Characteristic resistance	$V_{Rk,s,c,y}$	[kN]	120,0	120,0
	$V_{Rk,s,c,x}$	[kN]	43,8	48,0
Partial factor	$\gamma_{Ms}^{1)}$	[-]	1,8	
Steel failure: Local flexure of channel lips				
Characteristic spacing of channel bolts for $V_{Rk,s,l}$	$s_{l,v}$	[mm]	105	
Characteristic resistance	$V^0_{Rk,s,l,y}$	[kN]	92,0	
Partial factor	$\gamma_{Ms}^{1)}$	[-]	1,8	

¹⁾ In absence of other national regulations

fischer Serrated Anchor Channel InnoLock FES-RS-S with fischer Serrated Channel Bolts FBC-S

Characteristic resistance of anchor channel under shear load - steel failure of anchor channel

Annex C4
Appendix 20 / 23

Table 15: Characteristic resistance for shear load in direction of the longitudinal axis of the channel – steel failure

Anchor Channel FES-RS-S-(I)-			700	
Steel failure: Connection between channel lips and serrated channel bolt				
Characteristic resistance	$V_{Rk,s,l,x}$	[kN]	FBC-S-225-M12-8.8	.. ²⁾
			FBC-S-225-M16-8.8	22,5
			FBC-S-225-M20-8.8	22,5
Installation factor	γ_{inst} ¹⁾	[-]		1,2

¹⁾ In absence of other national regulations

²⁾ No performance assessed.

Table 16: Characteristic resistances of the anchor channel under shear load – concrete failure

Anchor Channel FES-RS-S-(I)-			700	
Concrete failure: Pry-out failure				
Product factor		k_B	[-]	2,0
Partial factor		γ_{Mc} ¹⁾	[-]	1,5
Concrete failure: Concrete edge failure				
Product factor k_{12}	Cracked concrete	$k_{cr,v}$	[-]	7,5
	Uncracked concrete	$k_{ucr,v}$	[-]	10,5
Partial factor		γ_{Mc} ¹⁾	[-]	1,5

¹⁾ In absence of other national regulations

fischer Serrated Anchor Channel InnoLock FES-RS-S with fischer Serrated Channel Bolts FBC-S

Performance
Characteristic resistance of anchor channel under shear load

Annex C5
Appendix 21 / 23

Table 17: Displacements under shear load

Anchor Channel FES-RS-S-(I)-			700
Shear load perpendicular to the longitudinal axis of the channel	V_y	[kN]	36,5
Short-term displacement ¹⁾	$\delta_{V,y,0}$	[mm]	2,9
Long-term displacement ¹⁾	$\delta_{V,y,\infty}$	[mm]	4,4
Shear load in direction of the longitudinal axis of the channel	V_x	[kN]	6,6
Short-term displacement ²⁾	$\delta_{V,x,0}$	[mm]	1,2
Long-term displacement ²⁾	$\delta_{V,x,\infty}$	[mm]	1,8

¹⁾ Displacements in midspan of the anchor channel, including slip of channel bolt, deformation of channel lips and slip of the anchor channel in concrete

²⁾ Displacements of the anchor channel, including slip of channel bolt, deformation of channel lips and slip of the anchor channel in concrete.

Table 18: Characteristic resistances under tension and shear load – steel failure of channel bolts

Channel bolt FBC-S-225			M12	M16	M20
Steel failure:			Steel grade 8.8		
Characteristic resistance	$N_{Rk,s}$	[kN]	67,4	125,6	170,0
Partial factor	γ_{Ms} ¹⁾	[-]	1,5		
Characteristic resistance	$V_{Rk,s}$	[kN]	33,7	62,8	98,0
Partial factor	γ_{Ms} ¹⁾	[-]	1,25		

¹⁾ In absence of other national regulations

Table 19: Characteristic resistances under combined tension and shear load

Anchor Channel FES-RS-S-(I)-			700
Steel failure: Local flexure of channel lips and flexure of channel			
Product factor	k_{13}	[-]	according to EN 1992-4:2018, 7.4.3.1
Steel failure: Anchor and connection between anchor and channel			
Product factor	k_{14}	[-]	according to EN 1992-4:2018, 7.4.3.1

fischer Serrated Anchor Channel InnoLock FES-RS-S with fischer Serrated Channel Bolts FBC-S

Performance

Characteristic resistance of channel bolts under tension and shear load,
Displacements under shear load, combined tension and shear load

Annex C6

Appendix 22 / 23

Table 20: Characteristic resistances under shear load with lever arm – steel failure of channel bolts

Channel bolt thread diameter ²⁾				M12	M16	M20
Steel failure						
Characteristic flexural resistance	$M^{0}_{Rk,s}$	[Nm]	FBC-S-225	104,8	266,4	519,3
Partial factor	γ_{Ms} ¹⁾	[-]	FBC-S-225	1,25		
Internal lever arm	a	[mm]	FBC-S-225	29,8	31,8	34,2

¹⁾ In absence of other national regulations

²⁾ Materials according to Annex A7, Table 6

The characteristic flexure resistance according to Table 19 is limited as follows:

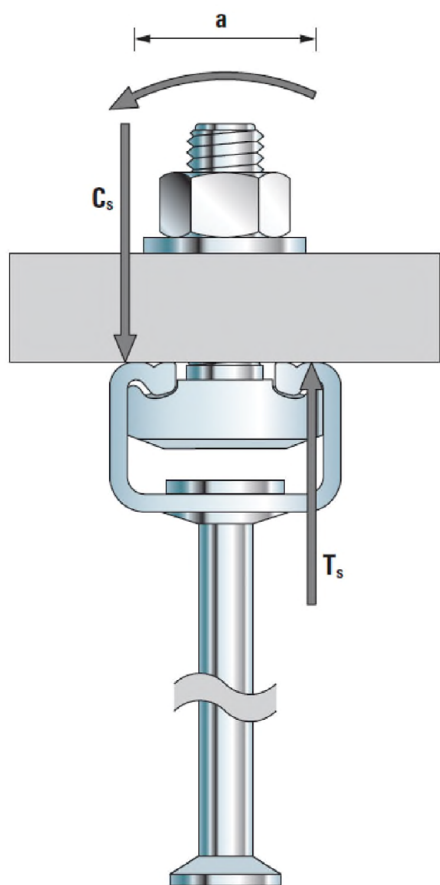

$$M^{0}_{Rk,s} \leq 0,5 \cdot N^{0}_{Rk,s,l} \cdot a \quad (N^{0}_{Rk,s,l} \text{ according to Annex C1, Table 10})$$

$$M^{0}_{Rk,s} \leq 0,5 \cdot N_{Rk,s} \cdot a \quad (N_{Rk,s} \text{ according to Annex C5, Table 18})$$

a = Internal lever arm according to Table 19

T_s = Tension force acting on the channel lips

C_s = Compression force acting on the channel lips

fischer Serrated Anchor Channel InnoLock FES-RS-S with fischer Serrated Channel Bolts FBC-S

Performance

Characteristic flexural resistances of channel bolts under shear load

Annex C7

Appendix 23 / 23