

TELJESÍTMÉNYNYILATKOZAT

DoP-FS-1006

fischer FiGM Intumescent Graphite Mastic ("Tűzgátló és tűzzáró termékek: Áttörési szigetelések)

HU

- A terméktípus egyedi azonosító kódja:** DoP-FS-1006
- Felhasználás célja(i):** Elválasztó elem tűzállóságának fenntartása azon a helyen, ahol a tűz továbbterjedhet, ld. a Mellékletet, különösen ezt a mellékletet, 1-2.
- Gyártó:** fischerwerke GmbH & Co. KG, Klaus-Fischer-Str. 1, 72178 Waldachtal, Németország
- A meghatalmazott képviselő:** -
- Az AVCP-rendszer(ek):** 1
- Az európai értékelési dokumentum:** EAD 350454-00-1104
Európai műszaki értékelés: ETA-20/1105; 2020-12-11
A műszaki értékelést végző szerv: ETA-Danmark A/S
Bejelentett szerv(ek): 2531 - DBI Certification A/S
- A nyilatkozatban szereplő teljesítmény(ek):**
Biztonság tűz esetén (BWR 2)
Tűzzel szembeni viselkedés: NPD
Tűzállóság: Mellékletek 3, 9-30
Higiénia, egészség- és környezetvédelem (BWR 3)
Légáteresztő képesség (anyagtulajdonság): Melléklet 4
Vízáteresztő képesség (anyagtulajdonság): NPD
Veszélyes anyagok tartalma, kibocsátása és / vagy kibocsátása: Melléklet 4
Biztonsági használat (BWR 4)
Mechanikai ellenállás és stabilitás: NPD
Ütésekkel/mozgásokkal szembeni ellenállás: NPD
Tapadás: NPD
Tartósság: Melléklet 5
Zaj elleni védelem (BWR 5)
Hangszigetelés: Melléklet 5
Energiatakarékoság és hőmegtartás (BWR 6)
Termikus tulajdonságok: NPD
Páraáteresztő képesség: NPD
- Megfelelő műszaki dokumentáció és/vagy egyedi műszaki dokumentáció:** -

A fent azonosított termék teljesítménye megfelel a bejelentett teljesítmény(ek)nek. A 305/2011/EU rendeletnek megfelelően e teljesítménynyilatkozat kiadásáért kizárólag a fent meghatározott gyártó a felelős

A gyártó nevében és részéről aláíró személy:



Dr.-Ing. Oliver Geibig, Üzleti egységek és Mérnökségért felelős vezérigazgató
Tumlingen, 2020-12-18



Jürgen Grün, Vegyi és Minőségért felelős vezérigazgató

Ez a Teljesítmény nyilatkozat különböző nyelveken elkészült. Vitás értelmezés esetén az angol verzió az irányadó.

A melléklet a (nyelvsemleges formában megadott) törvényi előírásokon túl önkéntesen megadott, kiegészítő információkat is tartalmaz angolul.

1 Technical Description of the Product

- 1) FiGM Intumescent Graphite Mastic is an acrylic based graphite sealant used to reinstate the fire resistance performance of wall and floor constructions where they have been provided with apertures for the penetration of single or multiple services.
- 2) FiGM Intumescent Graphite Mastic is gun applied to annular space around the service(s) to the required depth (for details see Annex C)
- 3) FiGM Intumescent Graphite Mastic is supplied in 330ml cartridges or 2.5kg, 5kg, 10kg pails.
- 4) FiGM Intumescent Graphite Mastic can be installed in conjunction with Fischer FCPS Coated Panel System ETA-20/1067.

2 Specification of the intended use(s) in accordance with the applicable European Assessment Document (hereinafter EAD)

The intended use of FiGM Intumescent Graphite Mastic is to reinstate the fire resistance performance of rigid and flexible walls and rigid floor constructions where they are penetrated by various cables, cable trays and plastic and insulated metallic pipes

- 5) The specific elements of construction that the system FiGM Intumescent Graphite Mastic may be used to provide a penetration seal in, are as follows:

- | | |
|-----------------|--|
| Rigid walls: | The wall must have a minimum thickness of 100 mm and comprise concrete, aerated concrete or masonry, with a minimum density of 650 kg/m ³ . |
| Rigid walls: | The wall must have a minimum thickness of 120 mm and comprise concrete, aerated concrete or masonry, with a minimum density of 650 kg/m ³ . |
| Rigid floors: | The floor must have a minimum thickness of 150 mm and comprise concrete, aerated concrete or masonry, with a minimum density of 650 kg/m ³ . |
| Flexible walls: | The wall must have a minimum thickness of 100 mm and comprise timber or steel studs lined on both faces with minimum 2 layers of 12,5 mm thick, 'Type F' Gypsum boards according to EN 520. In timber stud walls, no part of the penetration shall be closer than 100 mm to a stud, the cavity must be closed between the penetration seal and the stud and minimum 100 mm of insulation of class A1 or A2 according to EN 13501-1, is provided within the cavity between the penetration seal and the stud. |
| Flexible walls: | The wall must have a minimum thickness of 120 mm and comprise timber or steel studs lined on both faces with minimum 2 layers of 15 mm thick, 'Type F' Gypsum boards according to EN 520. In timber stud walls, no part of the penetration shall be closer than 100 mm to a stud, the cavity must be closed between the penetration seal and the stud and minimum 100 mm of insulation of class A1 or A2 according to EN 13501-1, is provided within the cavity between the penetration seal and the stud. |

The supporting construction must be classified in accordance with EN 13501-2 for the required fire resistance period.

- 6) The FiGM Intumescent Graphite Mastic may be used to provide a penetration seal with plastic and insulated metallic pipes, and cables and cable trays (for details see Annex C).
- 7) The total amount of cross sections of services (including insulation) should not exceed 60% of the penetration area.
- 8) The FiGM Intumescent Graphite Mastic may be used to seal apertures in the wall separating element up to 100mm wide by 300mm high. The FiGM Intumescent Graphite Mastic may be used to seal apertures in the floor separating element up to 250mm wide by 250mm high. The minimum permitted separation between adjacent seals/apertures is 200mm.
- 9) Pipes must be installed singular, cables require no minimum separation.
- 10) Services in walls and floors shall be supported at the distances specified in Annex C from the face of the separating element.
- 11) The provisions made in this European Technical Assessment are based on an assumed working life of the FiGM Intumescent Graphite Mastic of 10 years, provided that the conditions laid down in the product data sheet for the packaging/transport/ storage/installation/use/repair are met. The indications given on the working life cannot be interpreted as a guarantee given by the producer or the Technical Assessment Body, but are to be regarded only as a means for choosing the right products in relation to the expected economically reasonable working life of the works.

Use Category

Type Z₁: Intended for use in internal conditions with humidity equal to or higher than 85% RH excluding temperatures below 0°C, without exposure to rain or UV.

3 Performance of The Product And References To The Methods Used For Its Assessment

2	Safety in case of fire	
	Reaction to fire	See Clause 1.1
	Resistance to fire	See clause 1.2
3	Hygiene, Health and the Environment	
	Air permeability	See clause 2.1
	Content and release of dangerous substances	See clause 2.2
4	Safety and accessibility in use	
	Durability and serviceability	See clause 3.2
5	Protection against noise	
	Airborne sound insulation	See clause 3.3

3.1 Safety in case of fire

3.1.1 Reaction to fire

No performance assessed

3.1.2 Resistance to fire

FiGM Intumescent Graphite Mastic has been tested in accordance with BS EN 1366-3: 2009 based upon the test results and the field of direct application specified within EN 1366-3: 2009, the FiGM Intumescent Graphite Mastic has been classified in accordance with EN 13501-2, as given in Annex C:

The seals may only be penetrated by the services described in Annex C; other parts or support constructions must not penetrate the seal.

The service support construction must be fixed to the building element containing the penetration seal or a suitable adjacent building element, in such a manner that in the case of fire, no additional load is imposed on the seal. Furthermore, it is assumed that the unexposed face support is maintained for the required period of fire resistance.

Pipes must be perpendicular to the seal surface.

It is assumed that compressed air systems are switched off by other means in the case of fire.

The function of the pipe seal in case of pneumatic dispatch systems, pressurised air systems etc. is guaranteed only when the systems are shut off in case of fire.

The assessment does not cover the avoidance of destruction of the seal or of the abutting building element(s) by forces caused by temperature changes in case of fire. This has to be considered when designing the piping system.

The assessment does not address any risks associated with leakage of dangerous liquids or gases caused by failure of the pipe(s) in case of fire.

The durability assessment does not take account of the possible effect of substances permeating through the pipe on the penetration seal.

3.2 Hygiene, Health and the Environment.

3.1.1 Air permeability

FiGM Intumescent Graphite Mastichas been tested in accordance with BS EN 1314-1 to provide the following results:

Product Tested		fischer FiGM Intumescent Graphite Mastic		
Pressure (Pa)	Results under positive chamber pressure		Results under negative chamber pressure	
	Leakage (m ³ /h)	Leakage (m ³ /m ² /h)	Leakage (m ³ /h)	Leakage (m ³ /m ² /h)
50	0.2	5.6	0.3	8.3
100	0.4	11.1	0.6	16.7
150	0.7	19.4	0.9	25.0
200	1.0	27.8	1.2	33.3
250	1.1	30.6	1.6	44.4
300	1.2	33.3	1.9	52.8
450	2.2	61.1	2.7	75.0
600	2.4	66.7	3.4	94.4

3.2.2. Content and release of Dangerous Substances

The applicant have presented a declaration that Stopseal Coated Board and Coating is in compliance with Council Directive 76/769/EEC of 27th July 1976 on the approximation of the laws, regulations and administrative provisions of the Member States relating to restrictions on the marketing and use of certain dangerous substances and preparations (incl. all amendments and adaptations).

Fischerwerke GmbH declares that Product FiGM Intumescent Graphite Mastic is in compliance with Council Directive 76/769/EEC of 27th July 1976 on the approximation of the laws, regulations and administrative provisions of the Member States relating to restrictions on the marketing and use of certain dangerous substances and preparations (incl. all amendments and adaptations).

Confirmation has further been declared that all dangerous chemical substances ≥ 1.0 % w/w as well as all toxic, carcinogenic, toxic for reproduction and mutagenic chemical substances ≥ 0.1 % w/w (Status: 29. adaption – 2004/73/EG – of the EU directive 67/548/EEC - classification, packaging and labelling of dangerous substances) are stated in the FiGM Intumescent Graphite Mastic material safety data sheets (according to 91/155/EEC including amendments) and have been considered for the classification of the products according to the directive 1999/45/EG (classification of preparations, including amendments).amendments).

All dangerous chemical substances are below the classification limits of 67/548/EEC.

In addition to the specific clauses relating to dangerous substances contained in this European technical approval, there may be other requirements applicable to the products falling within its scope (e.g. transposed European

legislation and national laws, regulations, and administrative provisions). In order to meet the provisions of the Construction Products Regulation, these requirements need also to be complied with, when and where they apply.

3.3 Safety and accessibility in use

3.3.1 Durability

FiGM Intumescent Graphite Mastichas been tested in accordance with EOTA Technical Report - TR024 – EAD 350454-00-1104 – Firestopping and fire sealing products – Penetration Seals , for the type Z1, and the results of the tests have demonstrated suitability for penetration seals intended for use in internal conditions with humidity equal to or higher than 85% RH excluding temperatures below 0oC, without exposure to rain or UV.

3.4 Protection against noise

3.4.1 The results of the test provided the following single number rating:

$R_w(C:Ctr)=52(-1:-6)$

4 Assessment and verification of constancy of performance (hereinafter AVCP) system applied, with reference to its legal base

According to the decision 1999/454/EC of the European Commission the system of assessment and verification of constancy of performance (see Annex V to the Regulation (EU) No 305/2011) given in the following table apply:

Products	Intended use(s)	AVCP System
Fire stopping and fire sealing products	For fire compartmentation and/or fire protection or fire performance	System 1

Annex A

Reference Documents

EN 13501-1	Fire classification of construction products and building elements – Part 1: Classification using test data from reaction to fire tests
EN 13501-2	Fire classification of construction products and building elements – Part 2: Classification using test data from fire resistance tests
EOTA TR 024	Characterisation, Aspects of Durability and Factory Production Control for Reactive Materials, Components and Products

Annex B

Description of Product and Product

Literature fischer FiGM Intumescent Graphite Mastic

A detailed specification of the product is contained in document "Evaluation Report" relating to the European Technical Approval ETA – 14/0381 issued on 07/10/14, of fischer FiGM Intumescent Graphite Mastic which is a non-public part of this ETA.

Intumescent Graphite Mastic FiGM



High performance intumescent graphite fire resistant mastic





Cable tray through wall



Non-metallic pipes

Products

BUILDING MATERIALS

ASSESSMENT/APPROVAL

- Concrete
- Masonry
- Steel
- Timber

IBS EN 1026

BS EN ISO 140 3:1996

BS EN 1366-3: 2004



ETA-14/0381
1121-CFR-UK-0107

ADVANTAGES

- Low VOC
- Excellent acoustic properties
- Halogen and solvent free
- Excellent slump characteristics

APPLICATIONS

- Metallic pipes: 6" (159 mm)
- Non-metallic pipes: 5" (125 mm)
- Cable bunches: 1" (21 mm)
- Insulated service: 6" (159 mm)
- Construction joints: 1" (25 mm)
- Mixed services

FUNCTIONING

- FiGM is a one-part water-based flexible acrylic emulsion containing a high pressure intumescent graphite, which is used to seal service penetrations in both vertical and horizontal applications.
- It can expand up to 20 times its own volume and cures to form a resilient, flexible fire seal.



Annex C

Resistance to Fire Classification of FiGM Intumescent Graphite Mastic

C.1.1 Flexible and Rigid wall constructions according to 1.2.1 with wall thickness of minimum 120 mm

C.1.1.1 Penetration seal with FiGM Intumescent Graphite Mastic – Plastic Pipes

Construction details:

- FiGM Intumescent Graphite Mastic applied into the annular space to the required depth as per table C1.3
- First support positioned 150mm from both faces of the substrate

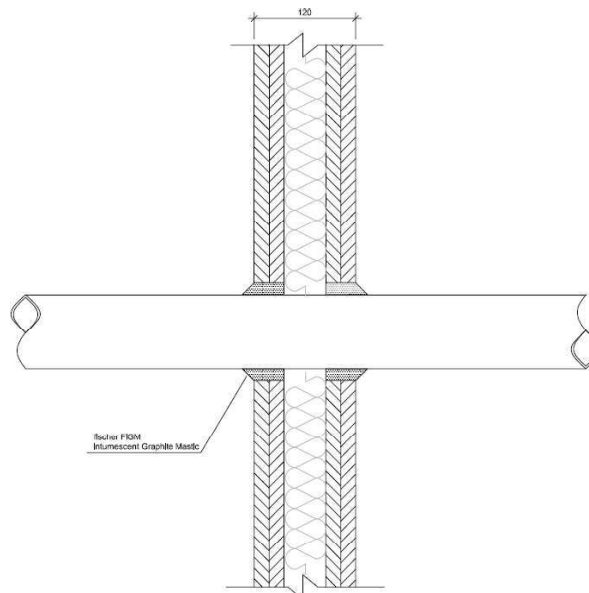

Penetration Specification	FiGM Intumescent Graphite Mastic (installed both faces)	Backing Material	Classification
PVC Pipe 40mm \varnothing 1.9-3mm wall thickness	10mm annulus x 25mm deep	N/A	EI120 U/C
PVC Pipe 125mm \varnothing 4.8-7.4mm wall thickness	16mm annulus x 25mm deep	30mm deep, 80Kg/m ³	EI120 U/C
HDPE Pipe 63mm \varnothing 7.2mm wall thickness, Cables up to 21mm \varnothing	300mm wide x 100mm high x 25mm deep	N/A	EI120 U/C
HDPE Pipe 90mm \varnothing 9.2mm wall thickness,	12.5mm annulus x 25mm deep	N/A	EI120 U/C
ABS Pipe 90mm \varnothing 6mm wall thickness,	12.5mm annulus x 25mm deep	N/A	EI120 U/C

C.1.2.1 Penetration seal with FiGM Intumescent Graphite Mastic – Insulated Metallic Pipes

- FiGM Intumescent Graphite Mastic applied into the annular space to the required depth as per table C2.3
- First support positioned 150mm from both faces of the substrate

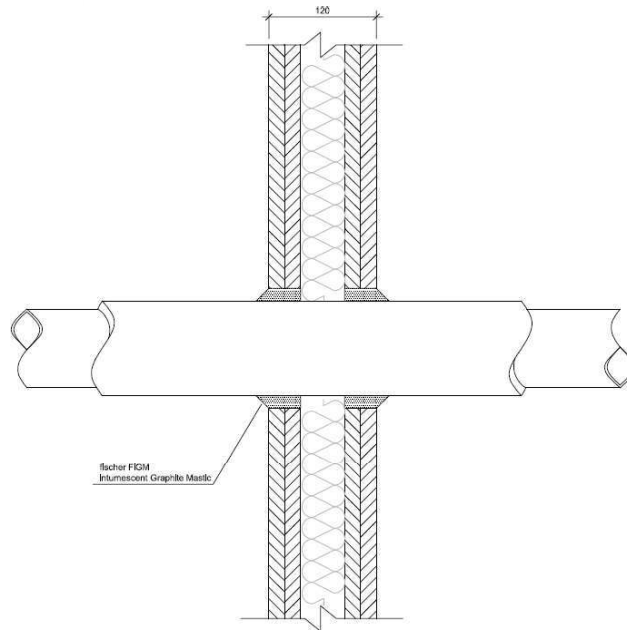

Penetration Specification	FiGM Intumescent Graphite Mastic (installed both faces)	Backing Material	Classification
Copper/Steel Pipe 60mm \varnothing 0.8mm -14.2mm wall thickness, insulated with 32mm 'Armaflex AF' (CS) Continued Sustained	20mm annulus x 25mm deep	N/A	E120 U/C EI90 U/C
Copper/Steel Pipe 15mm \varnothing 0.8mm -7mm wall thickness, insulated with 13mm 'Armaflex AF' (CS) Continued Sustained	15mm annulus x 25mm deep	N/A	E120 U/C

C.2.1 Flexible and Rigid wall constructions according to 1.2.1 with wall thickness of minimum 100 mm

C.2.1.1 Penetration seal with FiGM Intumescent Graphite Mastic – Plastic Pipes

Construction details:

- FiGM Intumescent Graphite Mastic applied into the annular space to the required depth as per table C3.3
- First support positioned 270mm from both faces of the substrate

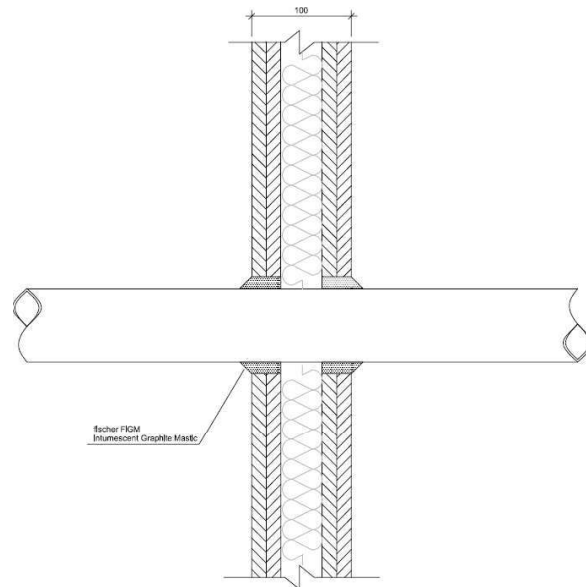

Penetration Specification	FiGM Intumescent Graphite Mastic (installed both faces)	Backing Material	Classification
PVC Pipe 40mm ø 1.9mm wall thickness	20mm annulus x 25mm deep	N/A	EI120 C/U
PVC Pipe 125mm ø 9.2mm wall thickness	20mm annulus x 25mm deep	N/A	EI60 C/U
ABS Pipe 40mm ø 1.9mm wall thickness	20mm annulus x 25mm deep	N/A	EI120 C/U
HDPP Pipe 40mmø 2mm wall thickness	20mm annulus x 25mm deep	N/A	EI120 C/U

C.2.2.1 Penetration seal with FiGM Intumescent Graphite Mastic – Insulated Metallic Pipes

Construction details:

- FiGM Intumescent Graphite Mastic applied into the annular space to the required depth as per table C4.3
- First support positioned 400mm from both faces of the substrate

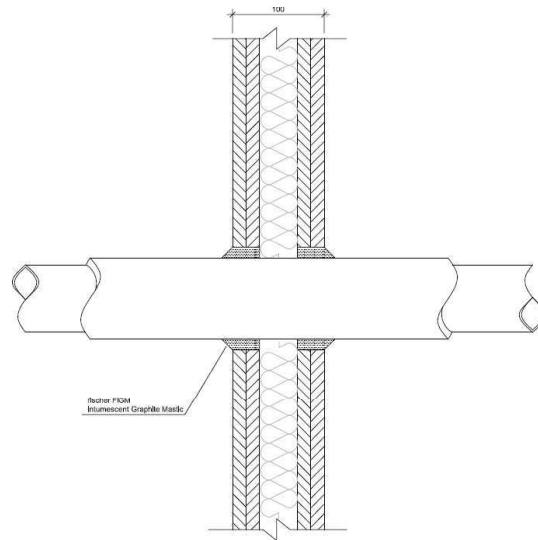

Penetration Specification	FiGM Intumescent Graphite Mastic (installed both faces)	Backing Material	Classification
Copper/Steel Pipe 40mm ϕ 1.5mm – 14.2mm wall thickness insulated with 32mm 'Armaflex AF' (LS 650mm) Local Sustained 650mm	20mm annulus x 25mm deep	N/A	E120 C/U EI30 C/U
Copper/Steel Pipe 40mm - 159mm ϕ 2.0 mm – 14.2mm wall thickness insulated with 32mm 'Armaflex AF' (LS 650mm) Local Sustained 650mm	20mm annulus x 25mm deep	N/A	E120 C/U EI30 C/U
Copper/Steel Pipe 159mm ϕ 2.0 mm – 14.2mm wall thickness insulated with 30mm x 80kg/m ³ 'Pipelane' SGR glass wool tube (LS 650mm) Local Sustained 650mm	20mm annulus x 25mm deep	N/A	E120 C/U EI30 C/U

C.2.3.1 Penetration seal with FiGM Intumescent Graphite Mastic – Insulated Metallic Pipes

Construction details:

- FiGM Intumescent Graphite Mastic applied into the annular space to the required depth as per table
- First support positioned 400mm from both faces of the substrate

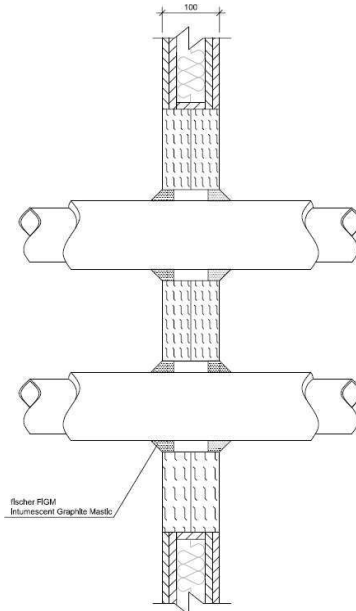

Penetration Specification	FiGM Intumescent Graphite Mastic	Fischer FCPS Coated Panel System	Classification
Copper/Steel Pipe 40mm ϕ 1.5mm -14.2mm wall thickness, insulated with 20mm thick foil faced glasswool insulation min density 80kg/m ³ (CS) Continued Sustained	15mm annulus, 15mm deep both faces of the Fischer FCPS Coated Panel System, incorporating a 15mm fillet projecting from the face of the seal	Double layer of 50mm Fischer FCPS Coated Panel System max 600mm high x 600mm wide	EI60 C/U
Copper/Steel Pipe 159mm ϕ 2.3mm -14.2mm wall thickness, insulated with 30mm thick foil faced glasswool insulation min density 80kg/m ³ (CS) Continued Sustained			E90 C/U EI60 C/U
Steel Pipe 40mm ϕ 1.7mm - 14.2mm wall thickness, insulated with 20mm thick foil faced glasswool insulation min density 80kg/m ³ (CS) Continued Sustained			E90 C/U EI60 C/U
Steel Pipe 150mm ϕ 2.3mm - 14.2mm wall thickness, insulated with 30mm thick foil faced glasswool insulation min density 80kg/m ³ (CS) Continued Sustained			EI60 C/U

C.3.1 Rigid wall constructions according to 1.2.1 with wall thickness of minimum 150 mm incorporating Fischer FCPS Coated Panel System

C.3.1.1 Penetration seal with FiGM Intumescent Graphite Mastic – Plastic Pipes

Construction details:

- FiGM Intumescent Graphite Mastic applied into the annular space to the required depth as per table
- First support positioned 400mm from both faces of the substrate

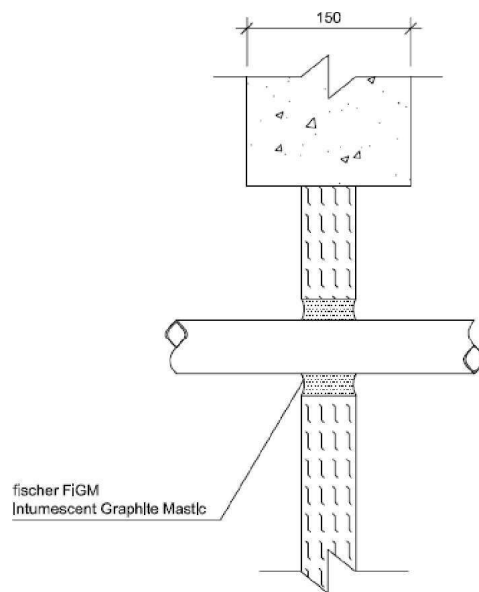

Penetration Specification	FiGM Intumescent Graphite Mastic	Fischer FCPS Coated Panel System	Classification
PVC Pipe 50mm \varnothing 2.4-7.4mm wall thickness	20mm annulus full 50mm depth of the Fischer FCPS Coated Panel System	Single layer of 50mm Fischer FCPS Coated Panel System max 1100mm high x 750mm wide	EI45 U/C
Pipe Diameters as below			See below

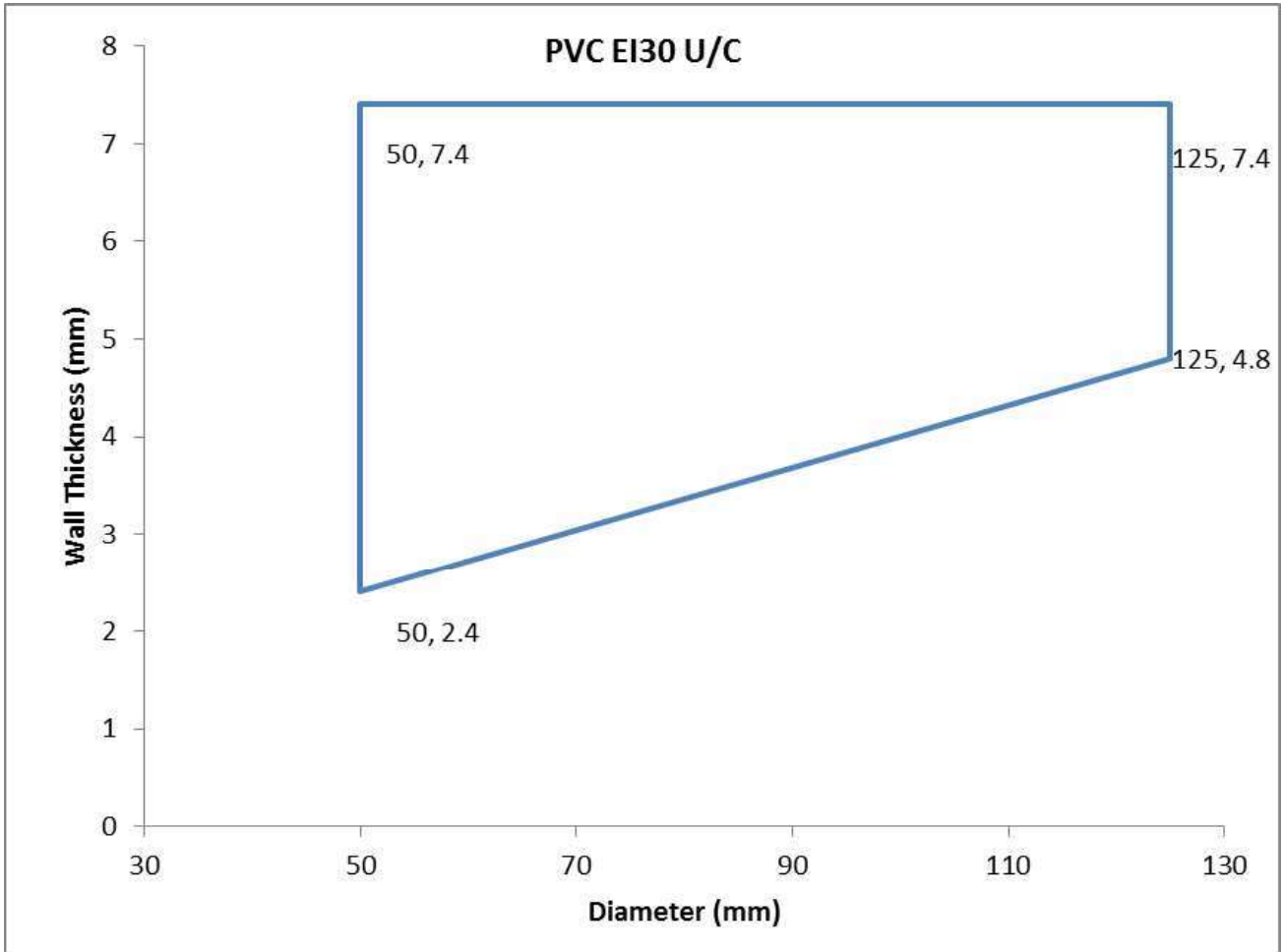

Penetration Specification	FIGM Intumescent Graphite Mastic	Fischer FCPS Coated Panel System	Classification
Uponor MLC (Multi-Layer Composite) Pipe 40mm ø 4mm wall thickness	20mm annulus full 50mm depth of the Fischer FCPS Coated Panel System	Single layer of 50mm Fischer FCPS Coated Panel System max 1100mm high x 750mm wide	E45 U/C EI30 U/C
Uponor MLC (Multi-Layer Composite) Pipe 50mm ø 4.5mm wall thickness			
Uponor MLC (Multi-Layer Composite) Pipe 63mm ø 6mm wall thickness			
Uponor MLC (Multi-Layer Composite) Pipe 75mm ø 7.5mm wall thickness			
Uponor MLC (Multi-Layer Composite) Pipe 90mm ø 8.5mm wall thickness			
Uponor MLC (Multi-Layer Composite) Pipe 110mm ø 10mm wall thickness			

Construction details:

- FiGM Intumescent Graphite Mastic applied into the annular space to the required depth as per table
- Stopeal Coated Batt 2 x 50mm thick
- First support positioned 400mm from both faces of the substrate

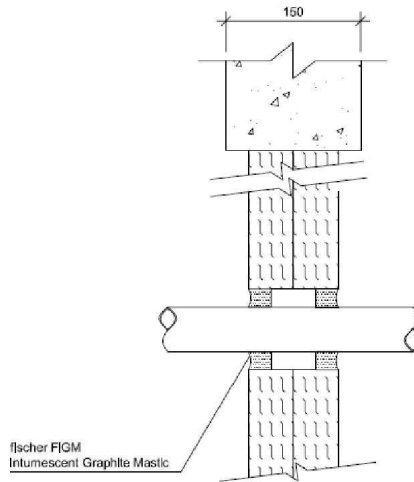

Penetration Specification	FiGM Intumescent Graphite Mastic	Fischer FCPS Coated Panel System	Classification
Pipe Diameters as below	20mm annulus, 25mm deep both faces of the Fischer FCPS Coated Panel System	Double layer of 50mm Fischer FCPS Coated Panel System max 1100mm high x 750mm wide	See below

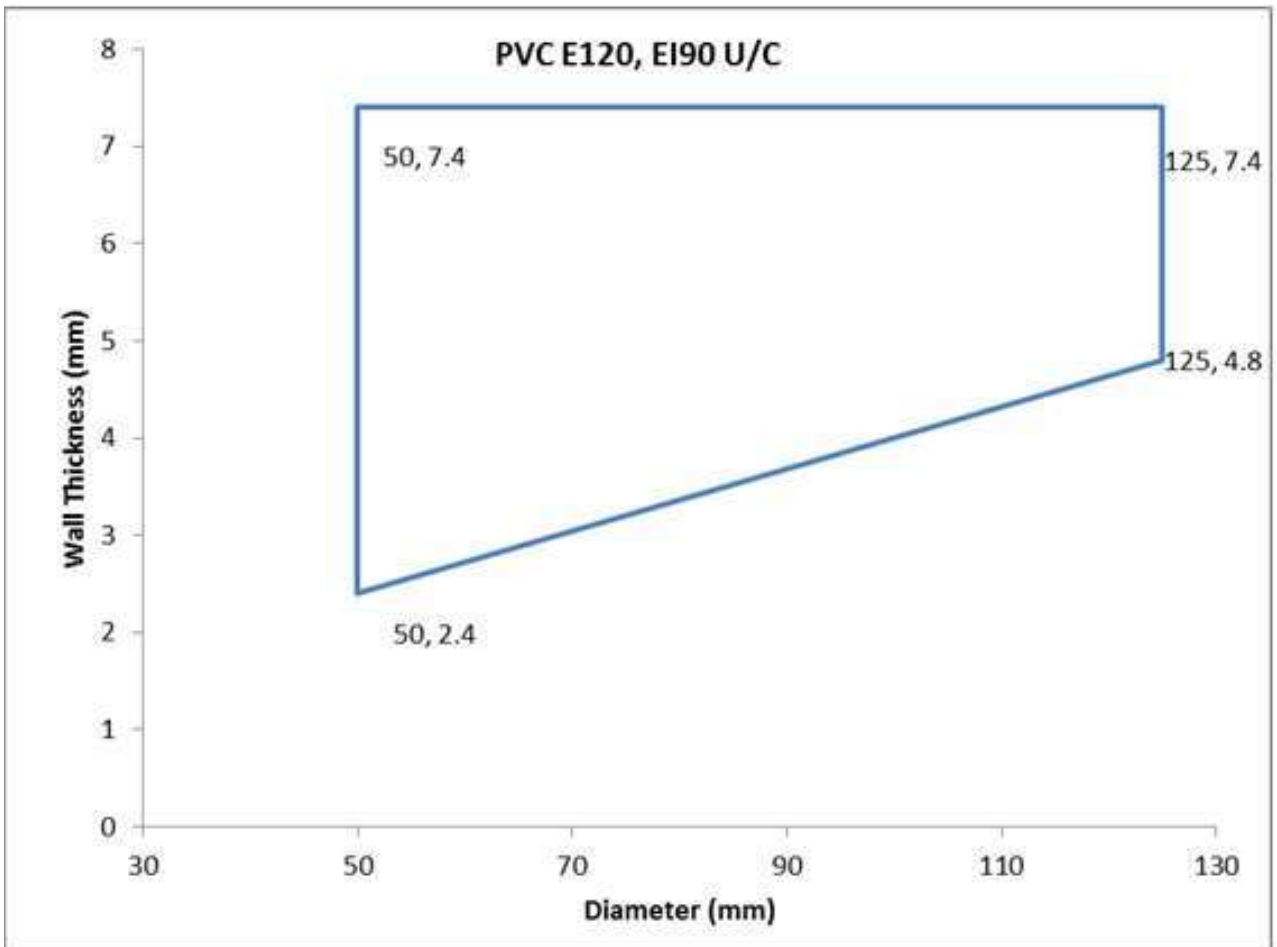
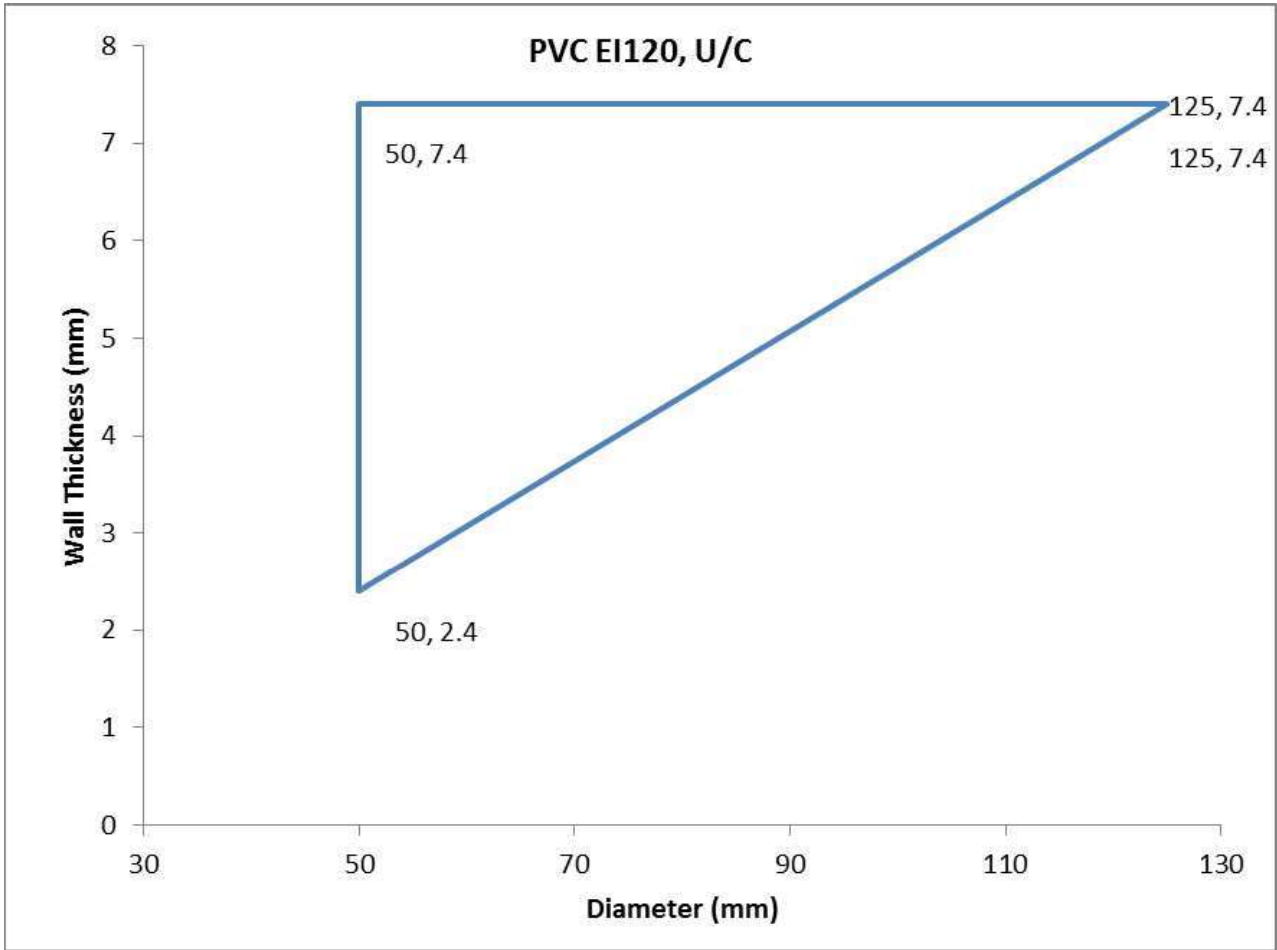

Penetration Specification	FiGM Intumescent Graphite Mastic	Fischer FCPS Coated Panel System	Classification
Uponor MLC (Multi-Layer Composite) Pipe 40mm ø 4mm wall thickness	20mm annulus, 25mm deep both faces of the Fischer FCPS Coated Panel System	Double layer of 50mm Fischer FCPS Coated Panel System max 1100mm high x 750mm wide	EI120 U/C
Uponor MLC (Multi-Layer Composite) Pipe 50mm ø 4.5mm wall thickness			
Uponor MLC (Multi-Layer Composite) Pipe 63mm ø 6mm wall thickness			
Uponor MLC (Multi-Layer Composite) Pipe 75mm ø 7.5mm wall thickness			
Uponor MLC (Multi-Layer Composite) Pipe 90mm ø 8.5mm wall thickness			
Uponor MLC (Multi-Layer Composite) Pipe 110mm ø 10mm wall thickness			

C.3.2.1 Penetration seal with FiGM Intumescent Graphite Mastic – Electrical Cables

Construction details:

- FiGM Intumescent Graphite Mastic applied into the annular space to the required depth as per table
- First support positioned 400mm from both faces of the substrate

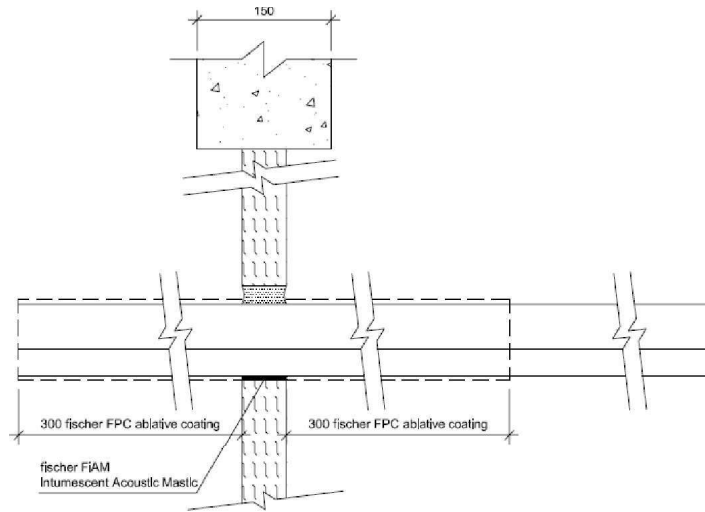

Penetration Specification	FiGM Intumescent Graphite Mastic	Fischer FCPS Coated Panel System	Classification
*500mm perforated cable tray	20mm gap full 50mm depth of the Fischer FCPS Coated Panel System	Single layer of 50mm Fischer FCPS Coated Panel System max 1100mm high x 750mm wide	EI30
*Electrical cables up to 21mm ø			EI45
*1 off 'C1' Cable			
*1 off 'C2' Cable			
*1 off 'C3' Cable			

*All cables coated with 2mm DFT FPC Panel Coating 300mm along the cables both sides of the seal

Construction details:

- FiGM Intumescent Graphite Mastic applied into the annular space to the required depth as per table
- First support positioned 400mm from both faces of the substrate

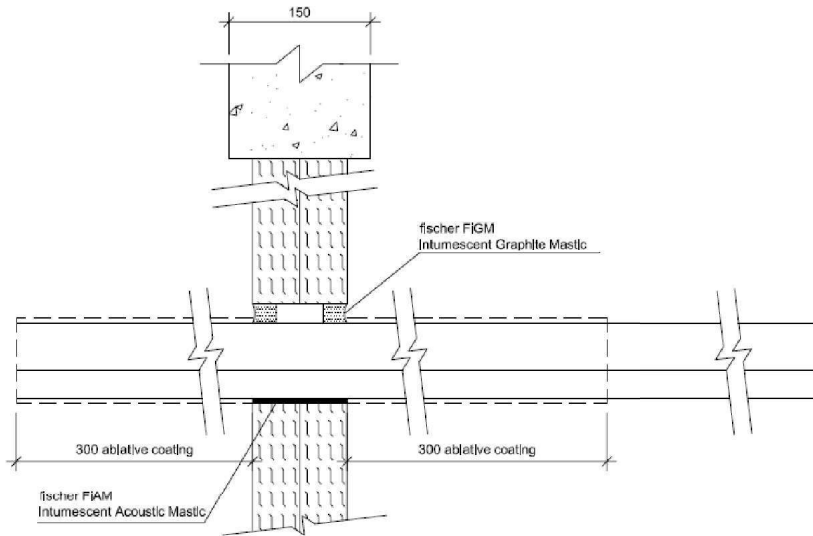

Penetration Specification	FiGM Intumescent Graphite Mastic	Fischer FCPS Coated Panel System	Classification
*500mm perforated cable tray	20mm annulus, 25mm deep both faces of the Fischer FCPS Coated Panel System	Double layer of 50mm Fischer FCPS Coated Panel System max 1100mm high x 750mm wide	EI120
*Electrical cables up to 21mm ø			
*1 off 'C1' Cable			
*1 off 'C2' Cable			E120 EI90
*1 off 'C3' Cable			EI120

*All cables coated with 2mm DFT FPC Panel Coating 300mm along the cables both sides of the seal

C.4.1 Rigid floor constructions according to 1.2.1 with floor thickness of minimum 150 mm

C4.1.1 Penetration seal with FiGM Intumescent Graphite Mastic – Electrical cables

Construction details:

- FiGM Intumescent Graphite Mastic applied into the annular space to the required depth as per table C5.3
- First support positioned 250mm from the upper face of the substrate

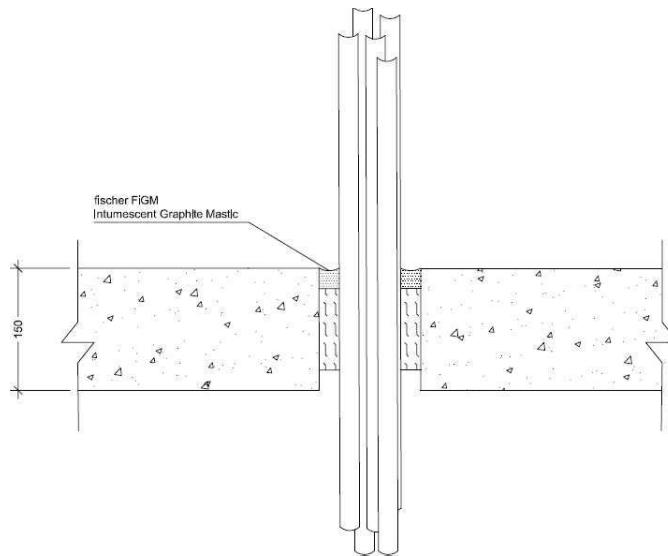

Penetration Specification	FiGM Intumescent Graphite Mastic (installed upper face only)	Aperture Size (mm)	Backing Material	Classification
Electrical Cables 0- 21mm Ø	25mm deep	Max 200 x 200 Min 50 x 50	100mm Deep stone wool 45 kg/m ³	E180 EI20
Electrical Cables 22- 80mm Ø				E120 EI20
Non sheathed electrical cables 0- 24mm Ø				E180 EI15
Up to 21mm Ø telecomm cables in bundles of up to 100 mm diameter				E180 EI20

C.4.2.1 Penetration seal with FiGM Intumescent Graphite Mastic – Insulated Metallic Pipes

Construction details:

- FiGM Intumescent Graphite Mastic applied into the annular space to the required depth as per table C6.3
- First support positioned 250mm from the upper face of the substrate

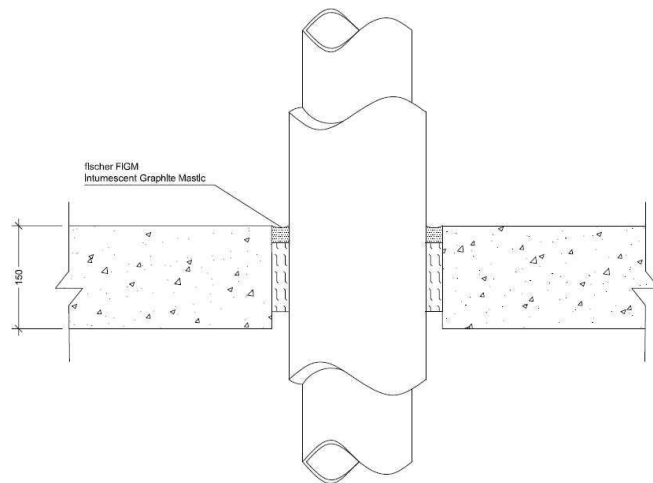

Penetration Specification	FiGM Intumescent Graphite Mastic (installed upper face only)	Aperture Size (mm)	Backing Material	Classification
Copper/Steel Pipe 41mm – 159mm ø 2.5mm - 14.2mm wall thickness, insulated with 16mm - 32mm 'Armaflex' (CS) Continued Sustained	25mm deep	20mm annulus	100mm Deep stone wool 45 kg/m ³	EI20 U/C
Copper/Steel Pipe 41mm 1.4 – 14.2mm wall thickness, insulated with 16mm 'Armaflex' (CS) Continued Sustained				E240 U/C EI60 U/C

C.4.3.1 Penetration seal with FiGM Intumescent Graphite Mastic – Plastic Pipes

Construction details:

- FiGM Intumescent Graphite Mastic applied into the annular space to the required depth as per table C 7.3-C 7.5
- First support positioned 250mm from the upper face of the substrate

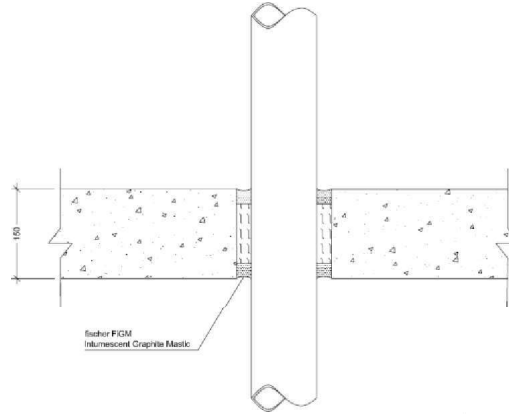

Penetration Specification	FiGM Intumescent Graphite Mastic (installed both faces)	Aperture Size (mm)	Backing Material	Classification
PP Pipe 110mm \varnothing 3.7mm wall thickness	25mm deep	20mm annulus	100mm Deep stone wool 45 kg/m ³	EI30 U/C
PP Pipe 110mm \varnothing 10.7mm wall thickness				EI120 U/C
PP Pipe 50mm \varnothing 2.1mm wall thickness				EI240 U/C

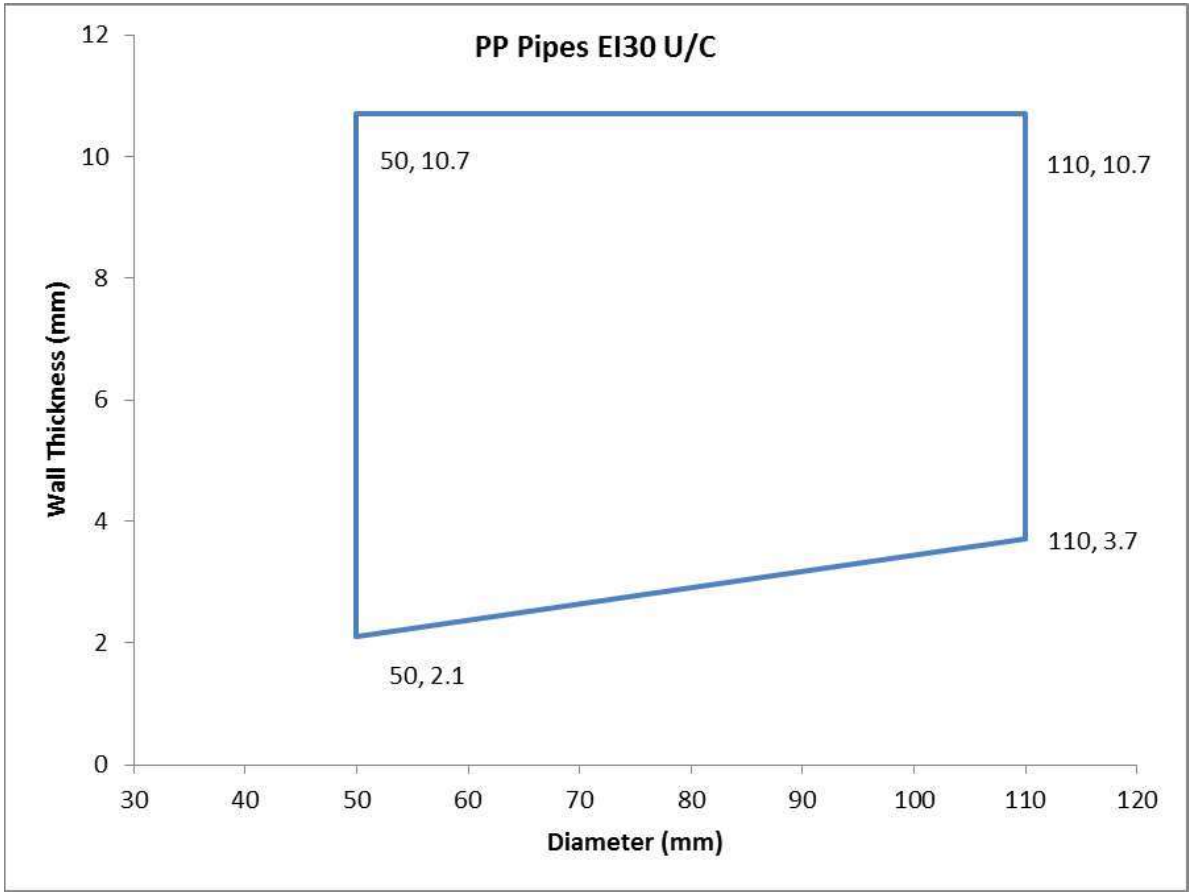

Penetration Specification	FiGM Intumescent Graphite Mastic (installed both faces)	Aperture Size (mm)	Backing Material	Classification
PE Pipe 40mm ø 4.1mm wall thickness	25mm deep	20mm annulus	100mm Deep stone wool 45 kg/m ³	EI240 U/C
PE Pipe 125mm ø 7.6 mm wall thickness				EI60 U/C
PE Pipe 125mm ø 11.4 mm wall thickness				EI90 U/C

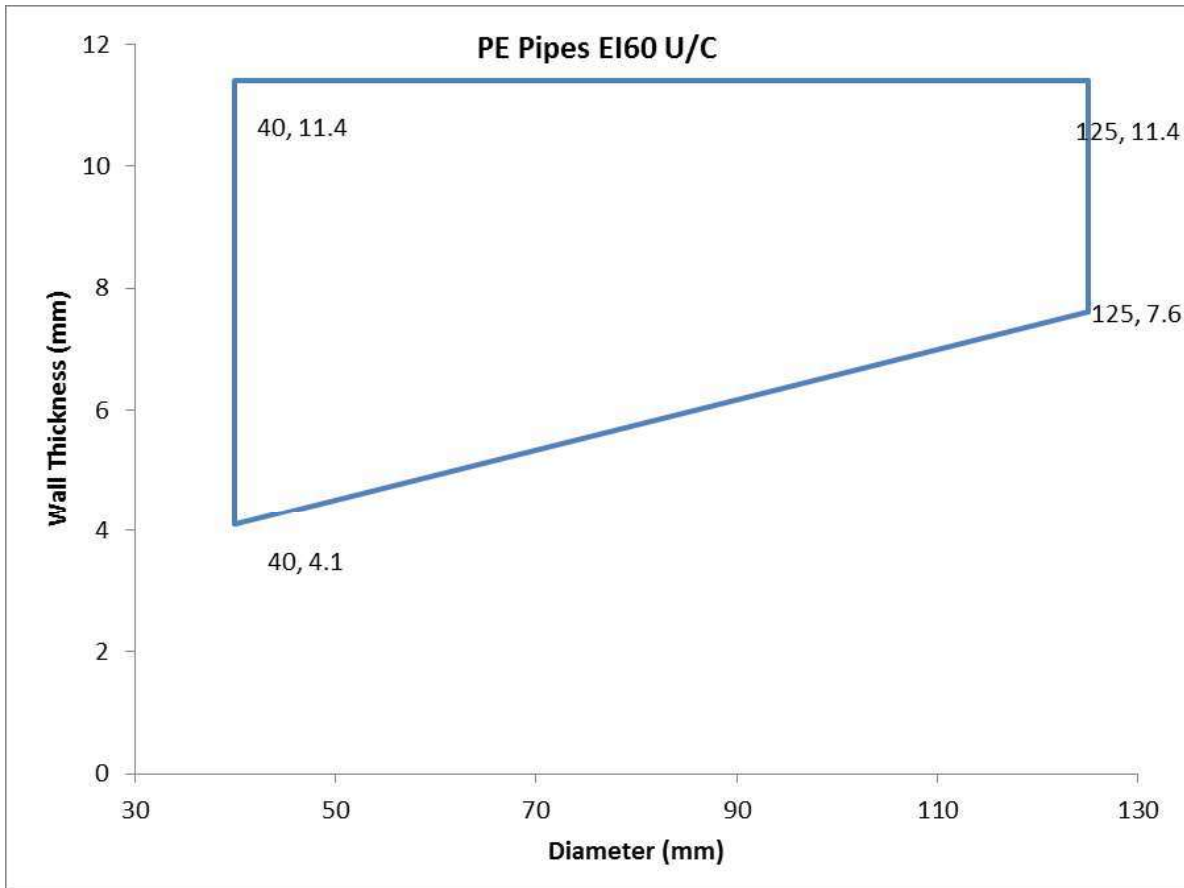

Penetration Specification	FIGM Intumescent Graphite Mastic (installed both faces)	Aperture Size (mm)	Backing Material	Classification
PVC Pipe 40mm ø 2mm wall thickness	25mm deep	20mm annulus	100mm Deep stone wool 45 kg/m ³	EI240 U/C
PVC Pipe 114mm ø 3.6 mm wall thickness				E90 U/C EI45 U/C
PVC Pipe 114mm ø 8.1 mm wall thickness				EI120 U/C

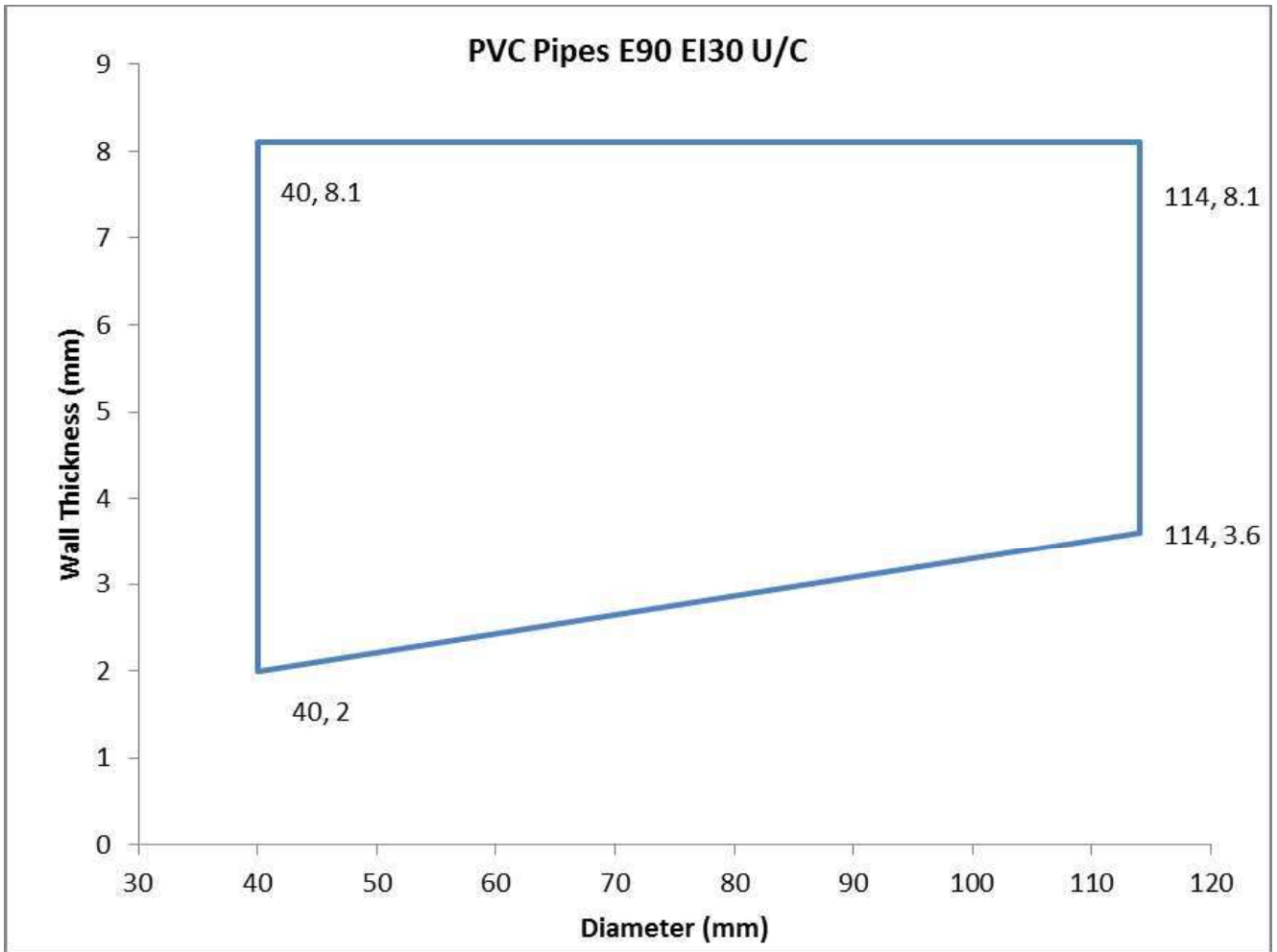

C.5.1 Rigid floor constructions according to 1.2.1 with wall thickness of minimum 150 mm incorporating Fischer FCPS Coated Panel System

C.5.1.1 Penetration seal with FiGM Intumescent Graphite Mastic – Plastic Pipes

Construction details:

- FiGM Intumescent Graphite Mastic applied into the annular space to the required depth as per table
- First support positioned 400mm from the upper face of the substrate

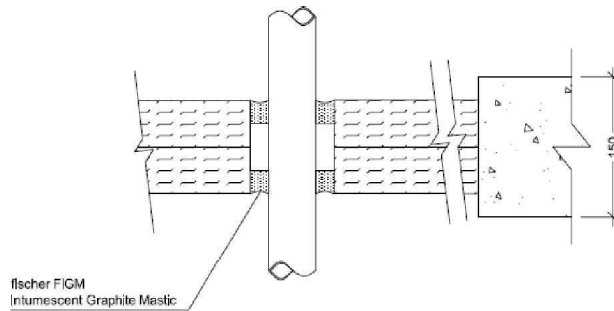

Penetration Specification	FiGM Intumescent Graphite Mastic	Fischer FCPS Coated Panel System	Classification
Pipe Diameters as below	20mm annulus, 25mm deep both faces of the Fischer FCPS Coated Panel System	Double layer of 50mm Fischer FCPS Coated Panel System max 1100mm high x 750mm wide	See below

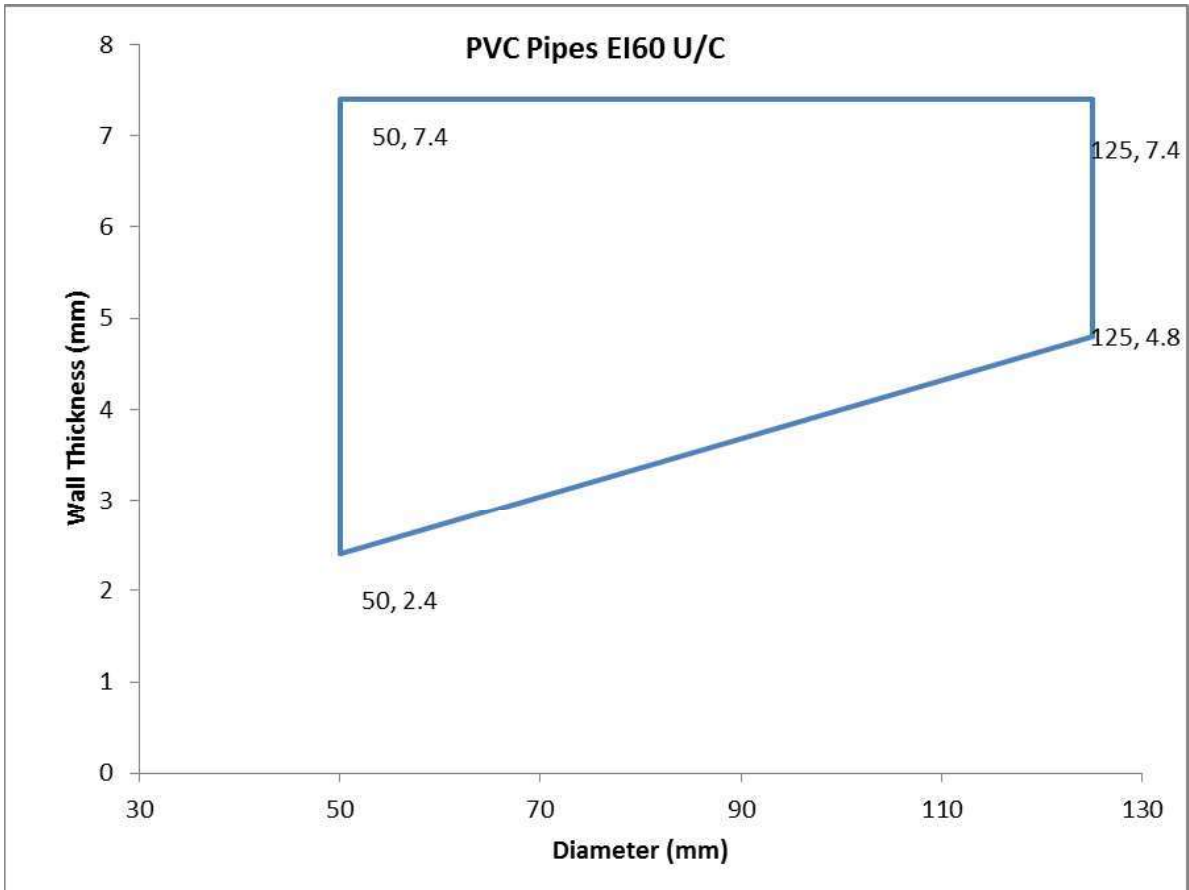

Penetration Specification	FiGM Intumescent Graphite Mastic	Fischer FCPS Coated Panel System	Classification
Uponor MLC (Multi-Layer Composite) Pipe 40mm ø 4mm wall thickness	20mm annulus, 25mm deep both faces of the Fischer FCPS Coated Panel System	Double layer of 50mm Fischer FCPS Coated Panel System max 1100mm high x 750mm wide	EI60 U/C
Uponor MLC (Multi-Layer Composite) Pipe 50mm ø 4.5mm wall thickness			
Uponor MLC (Multi-Layer Composite) Pipe 63mm ø 6mm wall thickness			
Uponor MLC (Multi-Layer Composite) Pipe 75mm ø 7.5mm wall thickness			
Uponor MLC (Multi-Layer Composite) Pipe 90mm ø 8.5mm wall thickness			
Uponor MLC (Multi-Layer Composite) Pipe 110mm ø 10mm wall thickness			

C.5.2.1 Penetration seal with FiGM Intumescent Graphite Mastic – Electrical Cables

Construction details:

- FiGM Intumescent Graphite Mastic applied into the annular space to the required depth as per table
- First support positioned 400mm from the upper face of the substrate

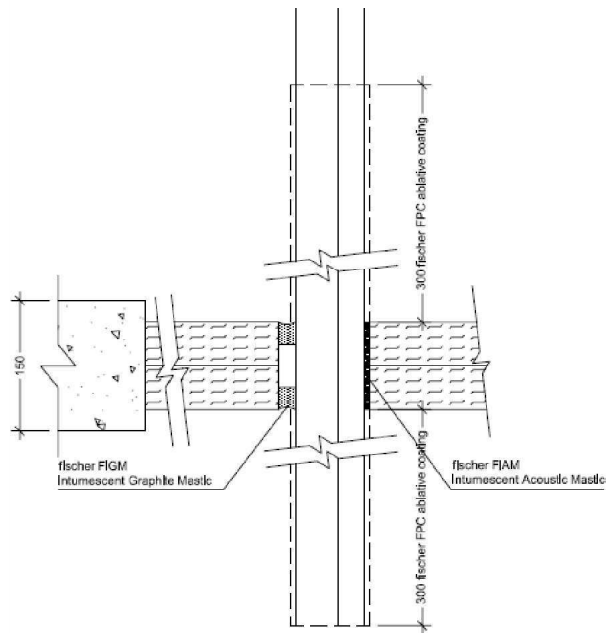

Penetration Specification	FiGM Intumescent Graphite Mastic	Fischer FCPS Coated Panel System	Classification
*500mm perforated cable tray	20mm annulus, 25mm deep both faces of the Fischer FCPS Coated Panel System	Double layer of 50mm Fischer FCPS Coated Panel System max 1100mm high x 750mm wide	EI60
*Electrical cables up to 21mm ø			
*1 off 'C1' Cable			
*1 off 'C2' Cable			
*1 off 'C3' Cable			

*All cables coated with 2mm DFT FPC Panel Coating 300mm a