



DICHIARAZIONE DI PRESTAZIONE



n. 0033 – IT

1. Codice di identificazione unico del prodotto-tipo: **FUR plastic anchor for concrete and masonry**

2. Usi previsti:

Prodotto	Uso/i previsto/i
Ancoranti plastici per uso multiplo in calcestruzzo e muratura per applicazioni non strutturali	Per l'utilizzo in sistemi come facciate per il fissaggio o il supporto dei elementi che contribuiscono alla stabilità dei sistemi, vedere l'appendice, specialmente gli Annessi 1 a 7

3. Fabbricante: **fischerwerke GmbH & Co. KG, Klaus-Fischer-Straße 1, 72178 Waldachtal, Germania**

4. Mandatario: --

5. Sistemi di VVCP: **2+**

6a. Norma armonizzata: ---

Organismi notificati: ---

6b. Documento per la valutazione europea: **ETAG 020, 2012-03**

Benestare Tecnico Europeo: **ETA-13/0235; 2013-06-25**

Organismo di valutazione tecnica: **ETA-Danmark A/S**

Organismi notificati: **1343 – MPA Darmstadt**

7. Prestazioni dichiarate:

Sicurezza in caso di incendio (BWR 2)

Caratteristiche essenziali	Prestazione
Reazione al fuoco	Gli ancoraggi soddisfano i requisiti per la Classe A1
Resistenza al fuoco	Vedere l'appendice 6

Sicurezza e accessibilità (BWR 4)

Caratteristiche essenziali	Prestazione
Resistenza caratteristica per azioni di trazione e di taglio	Vedere appendice, specialmente gli Annessi 4 - 7
Resistenza caratteristica del momento flettente	Vedere appendice, specialmente Annesso 3
Spostamenti sotto azioni di trazione e di taglio	Vedere appendice, specialmente Annesso 5
Distanze dell'ancorante e dimensioni dei supporti	Vedere appendice, specialmente gli Annessi 5 - 7

8. Documentazione tecnica appropriata e/o documentazione tecnica specifica: ---

La prestazione del prodotto sopra identificato è conforme all'insieme delle prestazioni dichiarate. La presente dichiarazione di responsabilità viene emessa, in conformità al regolamento (UE) n. 305/2011, sotto la sola responsabilità del fabbricante sopra identificato.

Firmato a nome e per conto del fabbricante da:

Andreas Bucher, Dipl.-Ing.

Wolfgang Hengesbach, Dipl.-Ing., Dipl.-Wirtsch.-Ing.

Tumlingen, 2015-08-20

- Questa Dichiarazione di Prestazione (DoP) è stata preparata in diverse lingue. In caso di divergenza d'interpretazione avrà sempre prevalenza la versione inglese.

- L'appendice include informazioni volontarie e complementari in lingua inglese (lingua specificata neutrale) eccetto i requisiti di legge

ETA-Danmark A/S
 Kollegievej 6
 DK-2920 Charlottenlund
 Tel. +45 72 24 59 00
 Fax +45 72 24 59 04
 Internet www.etadanmark.dk



Authorised and notified according to Article 10 of the Council Directive 89/106/EEC of 21 December 1988 on the approximation of laws, regulations and administrative provisions of Member States relating to construction products

MEMBER OF EOTA

European Technical Approval ETA-13/0235

Trade name:	fischer frame fixing FUR
Holder of approval:	fischerwerke GmbH & Co. KG Weinhalde 14 – 18 D-72178 Waldachtal
Generic type and use of construction product:	Plastic anchor for multiple use in concrete and masonry for non-structural applications
Valid from: to:	2013-06-25 2018-06-25
Manufacturing plant:	fischerwerke
This European Technical Approval contains:	16 pages including 7 annexes which form an integral part of the document



European Organisation for Technical Approvals

Europæisk Organisation for Tekniske Godkendelser

I LEGAL BASIS AND GENERAL CONDITIONS

1 This European Technical Approval is issued by ETA-Danmark A/S in accordance with:

- Council Directive 89/106/EEC of 21 December 1988 on the approximation of laws, regulations and administrative provisions of Member States relating to construction products¹⁾, as amended by Council Directive 93/68/EEC of 22 July 1993²⁾.
- Bekendtgørelse 559 af 27-06-1994 (afløser bekendtgørelse 480 af 25-06-1991) om ikrafttræden af EF direktiv af 21. december 1988 om indbyrdes tilnærmelse af medlemsstaternes love og administrative bestemmelser om byggevarer.
- Common Procedural Rules for Requesting, Preparing and the Granting of European Technical Approvals set out in the Annex to Commission Decision 94/23/EC³⁾.
- Guideline for European technical approval of "Plastic Anchors for Multiple Use in Concrete and Masonry for Non-structural Applications - Part 1: General", ETAG 020-01

2 ETA-Danmark A/S is authorized to check whether the provisions of this European Technical Approval are met. Checking may take place in the manufacturing plant. Nevertheless, the responsibility for the conformity of the products to the European Technical Approval and for their fitness for the intended use remains with the holder of the European Technical Approval.

3 This European Technical Approval is not to be transferred to manufacturers or agents of manufacturers other than those indicated on page 1, or manufacturing plants other than those indicated on page 1 of this European Technical Approval.

4 This European Technical Approval may be withdrawn by ETA-Danmark A/S pursuant to Article 5(1) of Council Directive 89/106/EEC.

- 1) Official Journal of the European Communities N° L40, 11 Feb 1989, p 12.
- 2) Official Journal of the European Communities N° L220, 30 Aug 1993, p 1.
- 3) Official Journal of the European Communities N° L 17, 20 Jan 1994, p 34.

5 Reproduction of this European Technical Approval including transmission by electronic means shall be in full. However, partial reproduction can be made with the written consent of ETA-Danmark A/S. In this case partial reproduction has to be designated as such. Texts and drawings of advertising brochures shall not contradict or misuse the European Technical Approval.

6 This European Technical Approval is issued by ETA-Danmark A/S in English. This version corresponds fully to the version circulated within EOTA. Translations into other languages have to be designated as such.

II SPECIAL CONDITIONS OF THE EUROPEAN TECHNICAL APPROVAL

1 Definition of product and intended use

Fischer FUR 10 is a plastic anchor consisting of a plastic sleeve made of polyamide and an accompanying specific screw of galvanised steel or galvanized steel with an additional Duplex-coating or of stainless steel.

The plastic sleeve is expanded by screwing in the specific screw which presses the sleeve against the wall of the drilled hole.

The installed anchor is shown in Annex 1

Intended use

The anchor is intended to be used for anchorages for which requirements for safety in use in the sense of the Essential Requirement 4 of Council Directive 89/106/EEC shall be fulfilled and failure of the fixture represents an immediate risk to human life.

The anchor is to be used only for multiple fixing for non-structural applications in concrete and masonry.

The base material may consist of use category a, b and c as given in the following Table:

Use category	Remarks
a	Normal weight concrete Strength class C12/15 at minimum according to EN 206-1:2000-12 Cracked and non-cracked concrete
b	Masonry walls according to Annex 6 Mortar strength class \geq M 2,5 according to EN 998-2:2003
c	Masonry walls according to Annex 6 Mortar strength class \geq M 2,5 according to EN 998-2:2003

Specific screws of galvanised steel:

The specific screws made of galvanised steel or galvanized steel with an additional Duplex-coating may only be used in structures subject to dry internal conditions.

These screws may also be used in structures subject to external atmospheric exposure, if the area of the head of the screw is protected against moisture and driving rain after mounting of the fixing unit in this way, that intrusion of moisture into the anchor shaft is prevented.

Therefore there shall be an external cladding or a ventilated rain screen mounted in front of the head of the screw and the head of the screw itself shall be coated with a soft plastic, permanently elastic bitumen-oil-combination coating (e. g. undercoating or body cavity protection for cars).

Specific screws of stainless steel (1.4362, 1.4401, 1.4404 and 1.4571):

The specific screw made of stainless steel may be used in structures subject to dry internal conditions and also in structures subject to external atmospheric exposure (including industrial and marine environment), or exposure in permanently damp internal conditions, if no particular aggressive conditions exist. Such particular aggressive conditions are e. g. permanent, alternating immersion in seawater or the splash zone of seawater, chloride atmosphere of indoor swimming pools or atmosphere with extreme chemical pollution (e. g. in desulphurization plants or road tunnels where de-icing materials are used).

The anchor may be used in the following temperature range:

Temperature range b): -20 °C to +80 °C (max long term temperature +50 °C and max short term temperature +80 °C)

Temperature range c): -20 °C to +50 °C (max long term temperature +30 °C and max short term temperature +50 °C)

Assumed working life

The assumed intended working life of the anchor for the intended use is 50 years, provided that they are subject to appropriate use and maintenance.

The information on the working life should not be regarded as a guarantee provided by the manufacturer or the approval body issuing the ETA. An "assumed intended working life" means that it is expected that, when this working life has elapsed, the real working life may be, in normal use conditions, considerably longer without major degradation affecting the essential requirements.

2 Characteristics of product and methods of verification

2.1 Characteristics of the product

The anchor corresponds to the drawings and information given in Annex 2 and 3. The characteristic material values, dimensions and tolerances of the anchor not given in these Annexes shall correspond to the respective values laid down in the technical documentation of this European Technical Approval. The technical documentation of this European Technical Approval is deposited at the ETA-Danmark and, as far as relevant for the tasks of the approved bodies involved in the attestation of conformity procedure, is handed over to the approved bodies.

The characteristic values for the design of the anchorages are given in Annex 4 to 7.

Each anchor is to be marked with the identifying mark, the type, the diameter and the length of the anchor according to Annex 2.

The minimum embedment depths shall be marked.

The anchor shall only be packaged and supplied as a complete unit.

2.2 Methods of verification

Methods of verification

The assessment of the fitness of the anchor for the intended use in relation to the requirements for safety in use in the sense of the Essential Requirement 4 has been made in compliance with the Guideline for European Technical Approval of "Plastic Anchors for Multiple Use in Concrete and Masonry for Non-structural Applications", ETAG 020,

- Part 1: "General",
- Part 2: "Plastic Anchors for Use in Normal Weight Concrete",
- Part 3: "Plastic Anchors for Use in Solid Masonry Materials" and
- Part 4: "Plastic Anchors for Use in Hollow or Perforated Masonry", based on the use categories a, b and c.

In addition to the specific clauses relating to dangerous substances contained in this European Technical Approval, there may be other requirements applicable to the products falling within its scope (e. g. transposed European legislation and national laws, regulations and administrative provisions). In order to meet the provisions of the Construction Products Directive, these requirements need also to be complied with, when and where they apply.

3 Attestation of Conformity and CE marking

3.1 Attestation of Conformity system

The system of attestation of conformity is 2+ described in Council Directive 89/106/EEC (Construction Products Directive) Annex III.

a) Tasks for the manufacturer:

- (1) Factory production control,
- (2) Initial type testing of the product,
- (3) testing of samples taken at the factory in accordance with a prescribed control plan.

b) Tasks for the notified body:

- (1) certification of factory production control on the basis of:
 - a. initial inspection of factory and of factory production control
 - b. continuous surveillance, assessment and approval of factory production control

3.2 Responsibilities

3.2.1 Tasks of the manufacturer

3.2.1.1 Factory production control

The manufacturer has a factory production control system in the plant and exercises permanent internal control of production. All the elements, requirements and provisions adopted by the manufacturer are documented in a systematic manner in the form of written policies and procedures. This production control system ensures that the product is in conformity with the European Technical Approval.

The manufacturer shall only use raw materials supplied with the relevant inspection documents as laid down in the control plan⁴.

The results of factory production control shall be recorded and evaluated in accordance with the provisions of the control plan.

3.2.1.2 Other tasks of the manufacturer

The manufacturer shall, on the basis of a contract, involve a body which is approved for the tasks

referred to in section 3.1 in the field of anchors in order to undertake the actions laid down in section 3.2.2. For this purpose, the control plan referred to in sections 3.2.1.1 and 3.2.2 shall be handed over by the manufacturer to the approved body involved.

The manufacturer shall make a declaration of conformity, stating that the construction product is in conformity with the provisions of this European Technical Approval.

3.2.2. Tasks of notified bodies

The notified body shall perform the

- initial inspection of factory and of factory production control,
- continuous surveillance, assessment and approval of factory production control,

in accordance with the provisions laid down in the control plan.

The approved body shall retain the essential points of its actions referred to above and state the results obtained and conclusions drawn in a written report.

The notified certification body involved by the manufacturer shall issue an EC certificate of conformity of the factory production control stating the conformity with the factory production control of this European Technical Approval.

In cases where the provisions of the European Technical Approval and its control plan are no longer fulfilled the certification body shall withdraw the certificate of conformity and inform ETA-Danmark without delay.

3.3 CE marking

The CE marking shall be affixed on each packaging of anchors. The initials "CE" shall be followed by the identification number of the notified body and shall be accompanied by the following information:

- the name and address of the producer (legal entity responsible for the manufacturer),
- the last two digits of the year in which the CE marking was affixed,
- the number of the EC certificate for the factory production control,
- the number of the European Technical Approval,
- the number of the guideline for European Technical Approval,
- use category a, b and c.

⁴ The control plan has been deposited at ETA-Danmark and is only made available to the approved bodies involved in the conformity attestation procedure.

4 Assumptions under which the fitness of the product for the intended use was favourably assessed

4.1 Manufacturing

The European Technical Approval is issued for the product on the basis of agreed data/information, deposited with ETA-Danmark, which identifies the product that has been assessed and judged. Changes to the product or production process, which could result in this deposited data/information being incorrect, should be notified to ETA-Danmark before the changes are introduced. ETA-Danmark will decide whether or not such changes affect the ETA and consequently the validity of the CE marking on the basis of the ETA and if so whether further assessment or alterations to the ETA shall be necessary.

4.2 Installation

4.2.1 Design of anchorages

Fitness for the intended use of the anchor is given under the following conditions:

- The design of anchorages is carried out in compliance with ETAG 020, Guideline for European Technical Approval of "Plastic Anchors for Multiple Use in Concrete and Masonry for Non-structural Applications", Annex C under the responsibility of an engineer experienced in anchorages.
- Verifiable calculation notes and drawings shall be prepared taking account of the loads to be anchored, the nature and strength of the base materials and the dimensions of the anchorage members as well as of the relevant tolerances.
- The anchor is to be used only for multiple fixing.
- Therefore the design of the fixture may specify the number n_1 of fixing points to fasten the fixture and the number n_2 of anchors per fixing point. Furthermore the design value of actions N_{Sd} on a fixing point to a value $\leq n_3$ (kN) is specified up to which the strength and stiffness of the fixture are fulfilled and the load transfer in the case of excessive slip or failure of one anchor need not be taken into account in the design of the fixture. The following default values for n_1 , n_2 and n_3 may be taken:
 - $n_1 \geq 4$; $n_2 \geq 1$ and $n_3 \leq 4,5$ kN or
 - $n_1 \geq 3$; $n_2 \geq 1$ and $n_3 \leq 3,0$ kN.
- Shear loads acting on an anchor may be assumed to act without lever arm if both of the following conditions are fulfilled:
 - The fixture shall be made of metal and in the area of the anchorage be fixed directly to the base material either without an intermediate layer or with a levelling layer of mortar with a thickness ≤ 3 mm.

- The fixture shall be in contact with the anchor over its entire thickness. (Therefore the diameter of clearance hole in the fixture d_f has to be equal or smaller than the value given in Annex 3, Table 3.)

If these two conditions are not fulfilled the lever arm is calculated according to ETAG 020, Annex C. The characteristic bending moment is given in Annex 3, Table 4.

4.2.2 Resistance in concrete (use category "a")

The characteristic values of resistance of the anchor for use in concrete are given in Annex 4 and 5. The design method is valid for cracked and non-cracked concrete.

According to the Technical Report TR 020 "Evaluation of anchorages in concrete concerning resistance to fire" it can be assumed that for fastening of facade systems the load bearing behaviour of the Fischer FUR 10 has a sufficient resistance to fire at least 90 minutes (R90) if the admissible load $[F_{Rk} / (\gamma_M \times \gamma_F)]$ is $\leq 0,8$ kN (no permanent centric tension load).

4.2.3 Resistance in solid masonry (use category "b")

The characteristic values of resistance of the anchor for use in solid masonry are given in Annex 6, Table 9. These values are independent of the load direction (tension, shear or combined tension and shear) and the mode of failure.

The characteristic resistances given in Annex 9 for use in solid masonry are only valid for the base material and the bricks according to this table or larger brick sizes and larger compressive strength of the masonry unit.

If smaller brick sizes are present on the construction site or if the mortar strength is smaller than the required value, the characteristic resistance of the anchor may be determined by job site tests according to 4.4.

4.2.4 Resistance in hollow or perforated masonry (use category "c")

The characteristic resistances for use in hollow or perforated masonry given in Annex 6, Table 9 are only valid for the bricks and blocks according to this table regarding base material, size of the units, compressive strength and configuration of the voids.

These values are independent of the load direction (tension, shear or combined tension and shear) and the mode of failure and are valid for $h_{nom} = 70$ mm only.

The influence of larger embedment depths ($h_{nom} > 70$ mm) and/or different bricks and blocks (according to Annex 9 regarding base material, size of the units, compressive strength and configuration of the voids) has to be detected by job site tests according to 4.4.

4.2.5 Specific conditions for the design method in solid masonry and hollow or perforated masonry

The mortar strength class of the masonry has to be M 2,5 according to EN 998-2:2003 at minimum.

The characteristic resistance F_{Rk} for a single plastic anchor may also be taken for a group of two or four plastic anchors with a spacing equal or larger than the minimum spacing s_{min} .

The distance between single plastic anchors or a group of anchors should be $s \geq 250$ mm.

If the vertical joints of the wall are designed not to be filled with mortar then the design resistance N_{Rd} has to be limited to 2,0 kN to ensure that a pull-out of one brick out of the wall will be prevented. This limitation can be omitted if interlocking units are used for the wall or when the joints are designed to be filled with mortar.

If the joints of the masonry are not visible the characteristic resistance F_{Rk} has to be reduced with the factor $\alpha_j = 0,5$.

If the joints of the masonry are visible (e.g. unplastered wall) following has to be taken into account:

- The characteristic resistance F_{Rk} may be used only, if the wall is designed such that the joints are to be filled with mortar.
- If the wall is designed such that the joints are not to be filled with mortar then the characteristic resistance F_{Rk} may be used only, if the minimum edge distance c_{min} to the vertical joints is observed. If this minimum edge distance c_{min} cannot be observed then the characteristic resistance F_{Rk} has to be reduced with the factor $\alpha_j = 0,5$.

4.2.6 Characteristic values, spacing and dimensions of anchorage member

The minimum spacing and dimensions of anchorage member according to Annex 5 and Annex 7 shall be observed depending on the base material.

4.2.7 Displacement behaviour

The displacements under tension and shear loading in concrete and masonry are given in Annex 5.

4.3 Installation of anchor

The fitness for use of the anchor can only be assumed if the following conditions of installation are met:

- Anchor installation carried out by appropriately qualified personnel under the supervision of the person responsible for technical matters on site.
- Use of the anchor only as supplied by the manufacturer without exchanging any component of the anchor.

- Anchor installation in accordance with the manufacturer's specifications and drawings using the tools indicated in this European Technical Approval.
- Checks before placing the anchor, to ensure that the characteristic values of the base material in which the anchor is to be placed, is identical with the values, which the characteristic loads apply for.
- Observation of the drill method. Other drilling methods may also be used if job-site tests according to 4.4 evaluate the influence of hammer or impact drilling.
- Placing drill holes without damaging the reinforcement.
- Holes to be cleaned of drilling dust.
- In case of aborted hole: New drilling at a minimum distance away of twice the depth of the aborted hole or smaller distance if the aborted drill hole is filled with high strength mortar.
- The plastic sleeve is inserted through the fixture by slight hammer blows and the special screw is screwed in until the head of the screw touches the sleeve. The anchor is correct mounted, if there is no turn-through of the plastic sleeve in the drill hole and if slightly move on turning of the screw is impossible after the complete turn-in of the screw.
- Temperature during installation of the anchor ≥ -20 °C (plastic sleeve and base material).

4.4 Job site tests according to ETAG 020, Annex B

4.4.1 General

In the absence of national requirements the characteristic resistance of the plastic anchor may be determined by job site tests, if the plastic anchor has already characteristic values given in Annex 4, 5 and 6 for the same base material as it is present on the construction works.

Furthermore job site tests for use in different concrete, solid masonry and hollow or perforated masonry are possible only if the plastic anchor has already characteristic values given in Annex 4, 5 and 6 for use in the equivalent base material.

Job site tests are also possible, if another drill method is been used.

The characteristic resistance to be applied to a plastic anchor should be determined by means of at least 15 pull-out tests carried out on the construction work with a centric tension load acting on the plastic anchor. These tests may also performed in a laboratory under equivalent conditions as used on construction work

Execution and evaluation of the tests as well as issue of the test report and determination of the characteristic resistance should be supervised by the person responsible for execution of works on site and be carried out by a competent person.

Number and position of the plastic anchors to be tested should be adapted to the relevant special conditions of the construction work in question and, for example, in the case of blind and larger areas be increased such that a reliable information about the characteristic resistance of the plastic anchor embedded in the base material in question can be derived. The tests should take account of the unfavourable conditions of practical execution.

4.4.2 Assembly

The plastic anchor to be tested shall be installed (e. g. preparation of drill hole, drilling tool to be used, drill bit, type of drilling hammer or rotation, thickness of fixture) and as far as spacing and edge distances are concerned be distributed in the same way as foreseen for the intended use.

Depending on the drilling tool hard metal hammer drill bits or hard metal percussion drill bits, respectively, according to ISO 5468 should be used. New drill bits should be used for one test series or drill bits with $d_{cut,m} = 10,25 \text{ mm} < d_{cut} \leq 10,45 \text{ mm} = d_{cut,max}$.

4.4.3 Execution of test

The test rig used for the pull-out tests shall provide a continuous slow increase of the load, controlled by a calibrated load cell. The load shall apply perpendicular to the surface of the base material and shall be transmitted to the anchor via a hinge. The reaction forces shall be transmitted into the base material such that possible breakout of the masonry is not restricted.

This condition is considered as fulfilled, if the support reaction forces are transmitted either in adjacent masonry units or at a distance of at least 150 mm from the plastic anchors. The load shall be increased continuously in a way that the ultimate load is reached after about 1 minute.

The load is measured when the ultimate load (N_1) is achieved.

If no pull-out failure occurs, other test methods are needed, e.g. proof-loading.

4.4.4 Test report

The test report shall include all information necessary to assess the resistance of the tested anchor. It shall be given to the person responsible for the design of the fastening and shall be included in the construction dossier.

The minimum data required are:

- Name of product
- Construction site, owner of building; date and location of the tests, air temperature
- Test rig
- Type of structure to be fixed

- Base material (e.g. type of brick, strength class, all dimensions of bricks, mortar group if possible); visual assessment of masonry (flush joints, joint clearance, regularity)
- Plastic anchor and special screw
- value of the cutting diameter of hard metal hammer-drill bits, measured before and after drilling if no new drill bits are used
- Results of tests including the indication of value N_1 ; mode of failure
- Tests carried out or supervised by ...; signature

4.4.5 Evaluation of test results

The characteristic resistance F_{Rk1} is derived from the measured values N_1 as follows

$$F_{Rk1} = 0,5 \cdot N_1$$

The characteristic resistance F_{Rk1} has to be equal or smaller than the characteristic resistance F_{Rk} which is given in the ETA for the equivalent base material

N_1 = the mean value of the five smallest measured values at ultimate load

In absence of national regulations the partial safety factors for the resistance of the plastic anchor may be taken as $\gamma_{Mc} = 1,8$ for use in concrete and $\gamma_{Mm} = 2,5$ for use in masonry.

5 Indications to the manufacturer

5.1 Responsibility of the manufacturer

It is in the responsibility of the manufacturer to ensure that the information on the specific conditions according to 1 and 2 including Annexes referred to 4 is given to those who are concerned. This information may be made by reproduction of the respective parts of the European Technical Approval. In addition, all installation data shall be shown clearly on the packaging and/or on an enclosed instruction sheet, preferably using illustrations.

The minimum data required are:

base material for the intended use,

- ambient temperature of the base material during installation of the anchor,
- drill bit diameter (d_{cut}),
- overall anchor embedment depth in the base material (h_{nom}),
- minimum hole depth (h_0),
- information on the installation procedure,
- identification of the manufacturing batch.

All data shall be presented in a clear and explicit form.

5.2 Packaging, transport and storage

The anchor shall only be packaged and supplied as a complete unit.

The anchor shall be stored under normal climatic conditions in its original light-proof packaging.

Appendix 9/16

Page 9 of 16 of European Technical Approval no. ETA-13/0235

Before installation, it shall not be extremely dried nor frozen.

A handwritten signature in blue ink, appearing to read 'Thomas Bruun', with a large loop at the start and a long, sweeping stroke at the end.

Thomas Bruun
Manager, ETA-Danmark

fischer long shaft fixing FUR

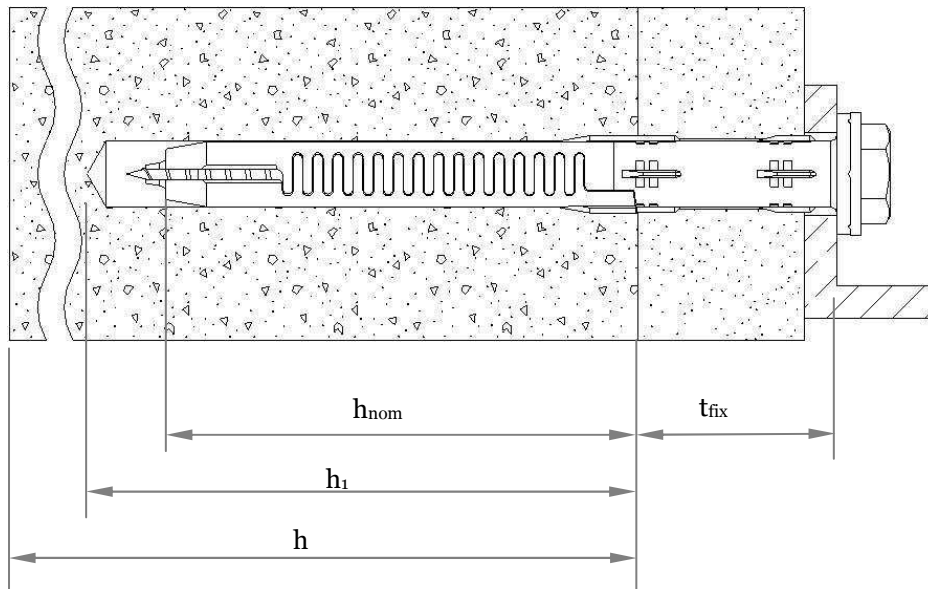

Intended Use

Fixing in concrete and different kinds of masonry

Legend

- h_{nom} = overall plastic anchor embedment depth in the base material
- h_1 = depth of drill hole to deepest point
- h = thickness of member (wall)
- t_{fix} = thickness of fixture and / or non-load bearing layer

fischer long shaft fixing FUR

Annex 1

Intended use

FUR

Anchor sleeve
countersunk version:

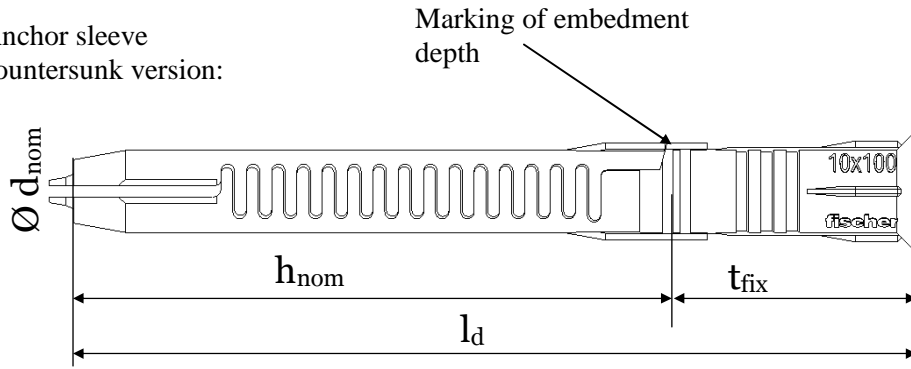

Marking:
Brand
Anchor type
Size
e.g. FUR 10x100

flat-collar version:

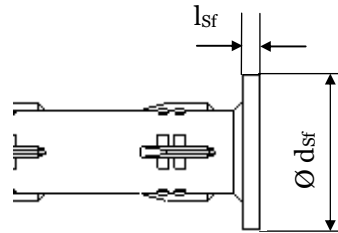

Special screw:

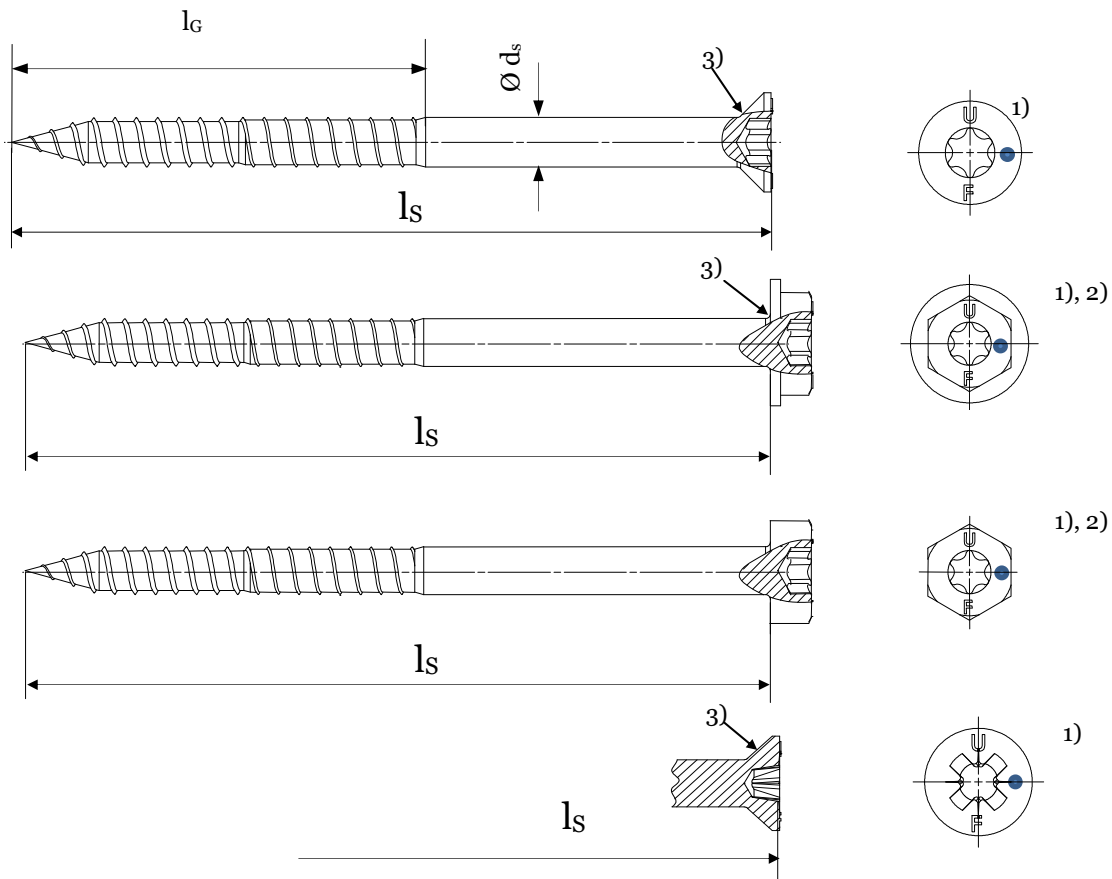

- 1) Additional marking of the special stainless steel screw: „A4“.
- 2) Internal driving feature for Torx bit is optional for hexagonal head
- 3) Optional additional version with underhead ribs

fischer long shaft fixing FUR

Annex 2

Dimensions

Table 1: Dimensions [mm]

Anchor type	Anchor sleeve						Special screw		
	h_{nom} [mm]	$\varnothing d_{nom}$ [mm]	t_{fix} [mm]	l_d [mm]	$l_{sf}^{2)}$ [mm]	$\varnothing d_{sf}$ [mm]	$\varnothing d_s$ [mm]	l_G [mm]	l_s [mm]
FUR 10	70	10	≥ 1	71-360	2,2	18,5	7,0	≥ 77	$\geq 78^{1)}$

1) To ensure that the screw penetrates the anchor sleeve, l_s must be $l_d + l_{sf}^{2)}$ + 7 mm

2) Only valid for flat collar version

Table 2: Materials

Name	Material
Anchor sleeve	Polyamide, PA6, colour grey
Special screw	Steel gvz A2G or A2F acc. to EN ISO 4042 or gvz A2G or A2F acc. to EN ISO 4042 + Duplex-coating type Delta-Seal in three layers (total layer thickness $\geq 6 \mu\text{m}$) or Stainless steel acc. to EN 10 088

Table 3: Installation parameters

Anchor type		FUR 10
Drill hole diameter	$d_0 =$ [mm]	10
Cutting diameter of drill bit	$d_{cut} \leq$ [mm]	10,45
Depth of drill hole to deepest point ¹⁾	$h_1 \geq$ [mm]	85
Overall plastic anchor embedment depth in the base material ^{1) 2)}	$h_{nom} \geq$ [mm]	70
Diameter of clearance hole in the fixture	$d_f \leq$ [mm]	12,5

1) See Annex 1

2) If the embedment depth is higher than h_{nom} given in Table 3 (only for hollow and perforated masonry), job site tests have to be carried out according to 4.2.1.4 and 4.2.3.

Table 4: Characteristic bending resistance of the screw in concrete and masonry

Anchor type		FUR 10	
Material		galvanised steel	stainless steel
Characteristic bending resistance ³⁾	$M_{Rk,s}$ [Nm]	17,7	17,1
Partial safety factor	$\gamma_{Ms}^{1)}$	1,25	1,29

1) In absence of other national regulations

fischer long shaft fixing FUR

**Dimensions, materials,
Installation parameters,
Characteristic bending resistance**

Annex 3

Table 5: Characteristic resistance of the screw for use in concrete

Failure of expansion element (special screw)		FUR 10	
		galvanized steel	stainless steel
Characteristic tension resistance ³⁾	$N_{Rk,s}$ [kN]	18,7	18,1
Partial safety factor	γ_{Ms} ¹⁾	1,50	1,55
Characteristic shear resistance ⁴⁾	$V_{Rk,s}$ [kN]	9,4	9,0
Partial safety factor	γ_{Ms} ¹⁾	1,25	1,29

1) In absence of other national regulations

Table 6: Characteristic resistance for use in concrete

Pull-out failure (plastic sleeve)		FUR 10
Concrete \geq C12/15		
Characteristic resistance	$N_{Rk,p}$ [kN]	4,5
Partial safety factor	γ_{Mc} ¹⁾	1,8
Concrete cone failure and concrete edge failure for single anchor and anchor group		
Tension load ²⁾		
$N_{Rk,c} = 7,2 \cdot \sqrt{f_{ck,cube}} \cdot h_{ef}^{1,5} \cdot \frac{c}{c_{cr,N}} = N_{Rk,p} \cdot \frac{c}{c_{cr,N}}$		with: $h_{ef}^{1,5} = \frac{N_{Rk,p}}{7,2 \cdot \sqrt{f_{ck,cube}}}$ $\frac{c}{c_{cr,N}} \leq 1$
Shear load ²⁾		
$V_{Rk,c} = 0,45 \cdot \sqrt{d_{nom}} \cdot (h_{nom}/d_{nom})^{0,2} \cdot \sqrt{f_{ck,cube}} \cdot c_1^{1,5} \cdot \left(\frac{c_2}{1,5c_1}\right)^{0,5} \cdot \left(\frac{h}{1,5c_1}\right)^{0,5}$		with: $\left(\frac{c_2}{1,5c_1}\right)^{0,5} \leq 1$ $\left(\frac{h}{1,5c_1}\right)^{0,5} \leq 1$
c_1	Edge distance closest to the edge in loading direction	
c_2	Edge distance perpendicular to direction 1	
$f_{ck,cube}$	Nominal characteristic concrete compression strength (based on cubes), value for C50/60 at maximum	
Partial safety factor	γ_{Mc} ¹⁾	1,8

1) In absence of other national regulations

2) The design method according to ETAG 020, Annex C is to be used

fischer long shaft fixing FUR

Annex 4

Characteristic resistance of the screw

Table 7: Displacements under tension and shear loading in concrete¹⁾, masonry¹⁾

Anchor type	Tension load			Shear load	
	F ²⁾ [kN]	δ_{NO} [mm]	$\delta_{N\infty}$ [mm]	δ_{VO} [mm]	$\delta_{V\infty}$ [mm]
FUR 10	1,8	0,62	1,24	3,39	5,09

1) Valid for all ranges of temperatures

2) Intermediate values by linear interpolation

Table 8: Minimum thickness of member, edge distance and spacing in concrete

Anchor type		Minimum thickness of member h_{min} [mm]	Characteristic edge distance $c_{cr,N}$ [mm]	Characteristic spacing $s_{cr,N}$ [mm]	Minimum allowable spacing and edge distances ¹⁾ [mm]
FUR 10	Concrete \geq C16/20	110	100	80	$s_{min} = 50$ for $c \geq 100$ $c_{min} = 50$ for $s \geq 150$
	Concrete C12/15		140	90	$s_{min} = 70$ for $c \geq 140$ $c_{min} = 70$ for $s \geq 210$

1) Intermediate values by linear interpolation

FUR 10: In case a fixing point consists of more than 1 anchor with spacing of $s \leq s_{cr,N}$, this fixing point is considered as a group with a max. characteristic resistance $N_{Rk,p}$ acc. to Table 6.

For $s > s_{cr,N}$, the anchors are always considered as single anchors, each with a characteristic resistance $N_{Rk,p}$ acc. to Table 6.

Scheme of distance and spacing in concrete

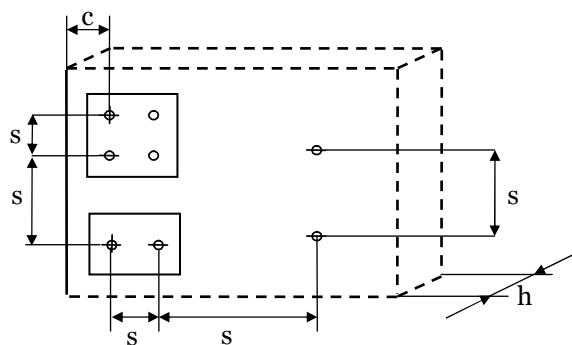

fischer long shaft fixing FUR

**Displacements
Edge distances and spacings**

Annex 5

Table 9: FUR 10 characteristic resistance F_{RK} in [kN] in solid and hollow masonry (use category “b” and “c”)

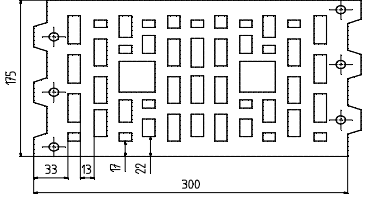
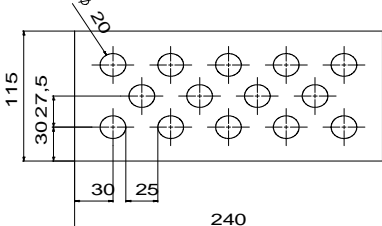
Base material [Supplier Title]	Geometry and min. DF or min. size (L x W x H) and drilling method [mm]	min. compressive strength f_b [N/mm ²] / bulk density $\geq \rho$ [kg/dm ³]	Characteristic resistance F_{RK} ¹⁾ FUR 10 [kN]
			50/80 °C
Clay solid brick Mz, e.g. Mz acc. to DIN 105-100, DIN EN 771-1 e.g. Schlagmann, Mz	NF (240x113x71) by hammer drilling	12/1,8	3,0
		10/1,8	2,5
		8/1,8	2,0
Calcium silicate solid brick e.g. KS acc. to DIN V 106, DIN EN 771-2 e.g. KS Wemding, KS	NF (240x113x71) by hammer drilling	20/1,8	2,5
		10/1,8	2,0
		8/1,8	1,5
	(500x175x235) by hammer drilling	12/1,8	3,5
		10/1,8	3,0
		8/1,8	2,5
Leightweight solid brick, e.g. acc. to DIN V 18152-100, DIN EN 771-3 e.g. KLB V	(250x240x245) by hammer drilling	8/1,6	3,0
		6/1,6	2,0
Clay brick Form B, HLz acc. to DIN 105-100, DIN EN 771-1		20/1,4	2,0
		16/1,4	1,7
		12/1,4	1,3
		10/1,4	1,0
Calcium silicate hollow brick e.g. KSL acc. to DIN V 106, DIN EN 771-2 e.g. KS Wemding, KSL		16/1,6	2,5
		12/1,6	2,0
		10/1,6	1,5
Partial safety factor ²⁾		γ_{Mm}	2,5

1) Characteristic resistance F_{RK} for tension, shear or combined tension and shear loading.

The characteristic resistance is valid for single plastic anchor or for a group of two or four plastic anchors with a spacing equal or larger than the minimum spacing s_{min} according to Table 11. The specific conditions for the design method have to be considered according to chapter 4.2.1.5 of the ETA.

2) In absence of other national regulations

fischer long shaft fixing FUR

Annex 6

Characteristic resistance in masonry (cat. b+c)

Table 10: Minimum distances and dimensions in masonry

Anchor type			FUR 10
Minimum thickness of member	h_{min}	[mm]	110
Single anchor			
Minimum allowable spacing	s_{min}	[mm]	250
Minimum allowable edge distance	c_{min}	[mm]	100
Anchor Group			
Minimum allowable spacing perpendicular to free edge	$s_{1,min}$	[mm]	100
Minimum allowable spacing parallel to free edge	$s_{2,min}$	[mm]	100
Minimum allowable edge distance	c_{min}	[mm]	100

Scheme of distance and spacing in masonry

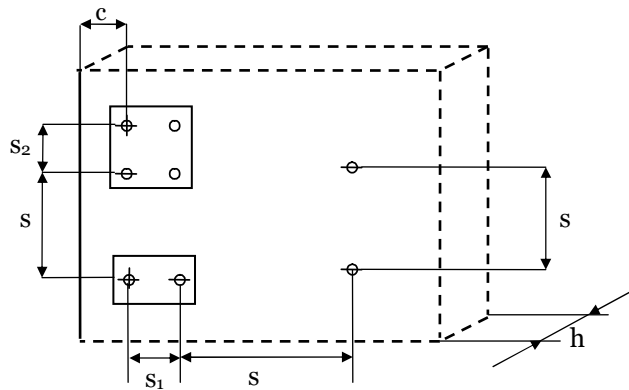

fischer long shaft fixing FUR

Annex 7

Minimum distances and dimensions in masonry