

DÉCLARATION DES PERFORMANCES

DoP 0396

pour fischer FIS EM Plus dynamic (Fixation dans du béton fissuré ou non fissuré)

FR

1. Code d'identification unique du type de produit: **DoP 0396**
2. Usage(s) prévu(s): **Cheville à scellement pour fixation dans le béton sous charge de fatigue cyclique, voir annexes, en particulier les annexes B1 - B9.**
3. Fabricant: **fischerwerke GmbH & Co. KG, Otto-Hahn-Straße 15, 79211 Denzlingen, Allemagne**
4. Mandataire: **-**
5. Système(s) d'évaluation et de vérification de la constance des performances: **1**
6. Document d'évaluation européen: **EAD 330250-01-0601**
Evaluation Technique Européenne: **ETA-23/0842; 2025-12-16**
Organisme d'évaluation technique: **DIBt- Deutsches Institut für Bautechnik**
Organisme(s) notifié(s): **2873 TU Darmstadt**
7. Performance(s) déclarée(s):
EAD 330250-01-0601; Table 2.1.3
Méthode d'évaluation C : fonction linéaire
Résistance mécanique et stabilité (BWR 1)
 - 1 Résistance caractéristique à la fatigue de l'acier sous charge de traction: Annexes C1, C3, C4
 - 2 Résistance caractéristique à la fatigue pour rupture par cône de béton, extraction glissement, fendage et éclatement du béton sous charge de traction: Annexes C1, C3, C4
 - 3 Résistance caractéristique à la fatigue pour extraction glissement ou rupture combinée par extraction glissement / cône de béton sous charge de traction: Annexes C1, C3, C4
 - 4 Résistance caractéristique à la fatigue de l'acier sous charge de cisaillement: Annexes C2, C3, C4
 - 5 Résistance caractéristique à la fatigue pour rupture du béton en bord de dalle sous charge de cisaillement: Annexes C2, C3, C4
 - 6 Résistance caractéristique à la fatigue pour rupture du béton par effet de levier sous charge de cisaillement: Annexes C2, C3, C4
 - 7 Résistance caractéristique à la fatigue de l'acier sous charge de traction et de cisaillement: Annexes C1 - C4
 - 8 Facteur de transfert de charge pour charge de traction et de cisaillement: Annexes C1 - C4
8. Documentation technique appropriée et/ou documentation technique spécifique: **-**

Les performances du produit identifié ci-dessus sont conformes aux performances déclarées. Conformément au règlement (UE) no 305/2011, la présente déclaration des performances est établie sous la seule responsabilité du fabricant mentionné ci-dessus.

Signé pour le fabricant et en son nom par:



Alexander Zanocco, Directeur Général des Ventes et Directeur Général de la Recherche & Développement
Tumlingen, 2026-04-14

Dieter Pfaff, Chef de la Fédération Internationale de Production et Gestion de la Qualité

Cette DoP a été préparée en plusieurs langues. En cas de différend relatif à l'interprétation, la version anglaise prévaudra.

L'annexe comprend des informations volontaires et complémentaires en langue anglaise dépassant les exigences légales (spécifiées de manière neutre).

EAD 330250-01-0601; Table 2.1.3; Assessment Method C: Linearized function
 EAD 330250-01-0601; Table 2.1.3; Méthode d'évaluation C : fonction linéaire

Mechanical resistance and stability (BWR 1) Résistance mécanique et stabilité (BWR 1)		
1	Characteristic steel fatigue resistance under tension loading: Résistance caractéristique à la fatigue de l'acier sous charge de traction:	$\Delta N_{RK,s,0,n}$ (n=1 to n=∞)
2	Characteristic concrete cone, pull-out, splitting and blow out fatigue resistance under tension loading: Résistance caractéristique à la fatigue pour rupture par cône de béton, extraction glissement, fendage et éclatement du béton sous charge de traction:	$\Delta N_{RK,c,0,n}; \Delta N_{RK,sp,0,n}$ (n=1 to n=∞)
3	Characteristic pull-out or combined pull-out /concrete cone fatigue resistance under tension loading: Résistance caractéristique à la fatigue pour extraction glissement ou rupture combinée par extraction glissement / cône de béton sous charge de traction:	$\Delta T_{RK,p,0,n};$ (n=1 to n=∞) $\Delta T_{RK,p,0,n};$ (n=1 to n=10 ⁸) $\Delta N_{RK,p,0,n};$ (n=1 to n=∞)
4	Characteristic steel fatigue resistance under shear loading: Résistance caractéristique à la fatigue de l'acier sous charge de cisaillement:	$\Delta V_{RK,s,0,n}$ (n=1 to n=∞)
5	Characteristic concrete edge fatigue resistance under shear loading: Résistance caractéristique à la fatigue pour rupture du béton en bord de dalle sous charge de cisaillement:	$\Delta V_{RK,c,0,n}$ (n=1 to n=∞)
6	Characteristic concrete pry-out fatigue resistance under shear loading: Résistance caractéristique à la fatigue pour rupture du béton par effet de levier sous charge de cisaillement:	$\Delta V_{RK,cp,0,n}$ (n=1 to n=∞)
7	Characteristic steel fatigue resistance under tension and shear: Résistance caractéristique à la fatigue de l'acier sous charge de traction et de cisaillement:	α_s
8	Load transfer factor for tension and shear loading: Facteur de transfert de charge pour charge de traction et de cisaillement:	Ψ_{FN}, Ψ_{FV}

Specific Part

1 Technical description of the product

The "fischer injection system FIS EM Plus dynamic" is a bonded fastener consisting of a cartridge with injection mortar fischer FIS EM Plus and a steel element according to Annex A3.

The steel element is placed into a drilled hole filled with injection mortar and is anchored via the bond between metal part, injection mortar and concrete.

The product description is given in Annex A.

2 Specification of the intended use in accordance with the applicable European Assessment Document

The performances given in Section 3 are only valid if the anchor is used in compliance with the specifications and conditions given in Annex B.

The verifications and assessment methods on which this European Technical Assessment is based lead to the assumption of a working life of the anchor of at least 50 years. The indications given on the working life cannot be interpreted as a guarantee given by the producer, but are to be regarded only as a means for choosing the right products in relation to the expected economically reasonable working life of the works.

3 Performance of the product and references to the methods used for its assessment

3.1 Mechanical resistance and stability (BWR 1)

Essential characteristic (Assessment method C: Linearized function)	Performance
Characteristic fatigue resistance under cyclic tension loading	
Characteristic steel fatigue resistance $\Delta N_{Rk,s,0,n}$ ($n = 1$ to $n = \infty$)	See Annex C1, C3 and C4
Characteristic concrete cone and splitting fatigue resistance $\Delta N_{Rk,c,0,n}$ $\Delta N_{Rk,sp,0,n}$ ($n = 1$ to $n = \infty$)	
Characteristic combined pull-out /concrete cone fatigue resistance $\Delta \tau_{Rk,p,0,n}$ ($n = 1$ to $n = \infty$)	
Characteristic fatigue resistance under cyclic shear loading	
Characteristic steel fatigue resistance $\Delta V_{Rk,s,0,n}$ ($n = 1$ to $n = \infty$)	See Annex C2, C3 and C4
Characteristic concrete edge fatigue resistance $\Delta V_{Rk,c,0,n}$ ($n = 1$ to $n = \infty$)	
Characteristic concrete pry out fatigue resistance $\Delta V_{Rk,cp,0,n}$ ($n = 1$ to $n = \infty$)	

Essential characteristic (Assessment method C: Linearized function)	Performance
Characteristic fatigue resistance under cyclic combined tension and shear loading	
Characteristic steel fatigue resistance a_s ($n = 1$ to $n = \infty$)	See Annex C1 to C4
Load transfer factor for cyclic tension and shear loading	
Load transfer factor ψ_{FN}, ψ_{FV}	See Annex C1 to C4

4 Assessment and verification of constancy of performance (AVCP) system applied, with reference to its legal base

In accordance with European Assessment Document No. 330250-01-0601, the applicable European legal act is: [96/582/EC].

The system to be applied is: 1

5 Technical details necessary for the implementation of the AVCP system, as provided for in the applicable European Assessment Document

Technical details necessary for the implementation of the AVCP system are laid down in the control plan deposited with Deutsches Institut für Bautechnik.

Installation conditions

fischer anchor rod FIS A or RG M with fischer injection system FIS EM Plus

Pre-positioned installation with dynamic set (annular gap filled with mortar)

Size: M12, M16, M20, M24

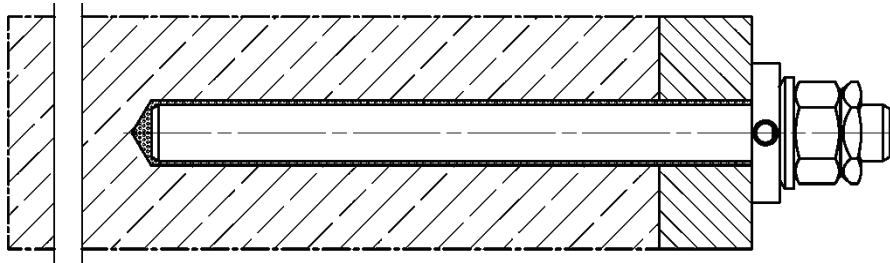

Push through installation with dynamic set (annular gap filled with mortar)

Size: M12, M16, M20, M24

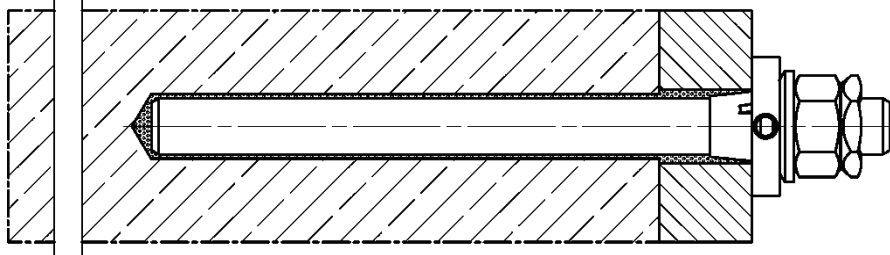

Push through installation with washer and centering sleeve (annular gap filled with mortar)

Size: M12, M16, M20, M24

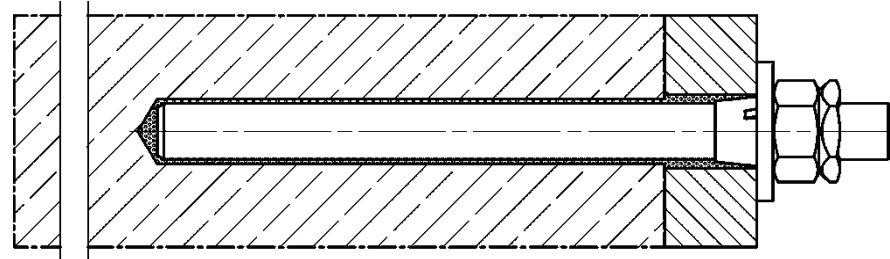

Figures not to scale

fischer FIS EM Plus dynamic

Product description
Installed condition

Annex A1

Appendix 3 / 19

Overview system components Part 1

Injection cartridge (shuttle cartridge) FIS EM Plus with sealing cap

Sizes: 390 ml, 585 ml, 1500 ml (the 390 ml hard cartridge is shown as an example)

Size foil bag: 500 ml

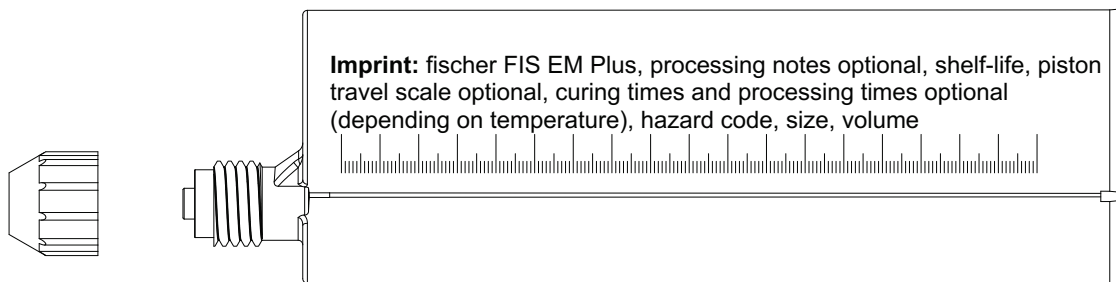

Injection cartridge (coaxial cartridge) FIS EM Plus with sealing cap

Sizes: 300 ml

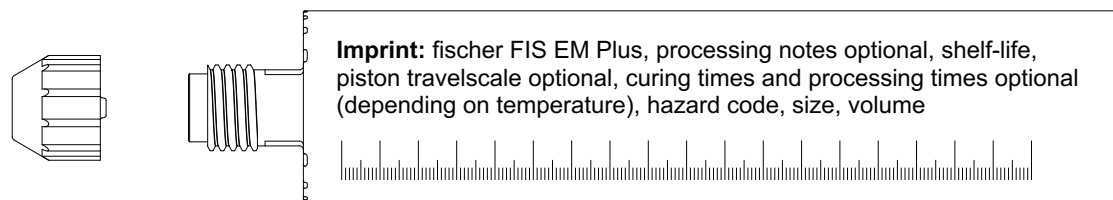

Static mixer FIS MR Plus for injection cartridges ≤ 500 ml

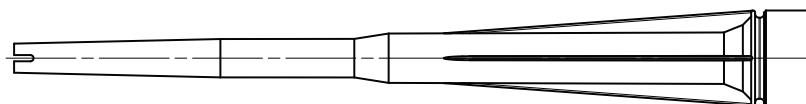

Static mixer FIS UMR for injection cartridges ≥ 500 ml

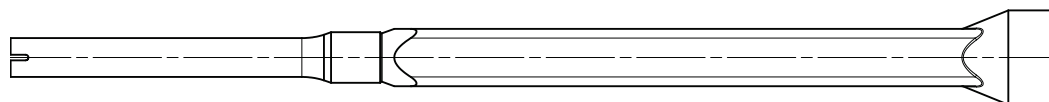

Injection adapter and extension tube $\varnothing 9$ for static mixer FIS MR Plus;
Injection adapter and extension tube $\varnothing 9$ or $\varnothing 15$ for static mixer FIS UMR

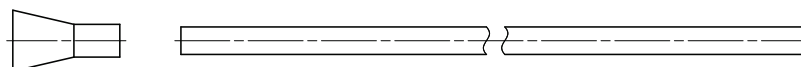

Figures not to scale

fischer FIS EM Plus dynamic

System description

Overview system components part 1;
cartridges / static mixer / injection adapter

Annex A2

Appendix 4 / 19

Overview system components Part 2

fischer anchor rod FIS A

Size: M12, M16, M20, M24

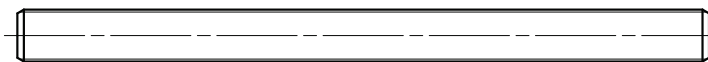

fischer anchor rod RG M

Size: M12, M16, M20, M24

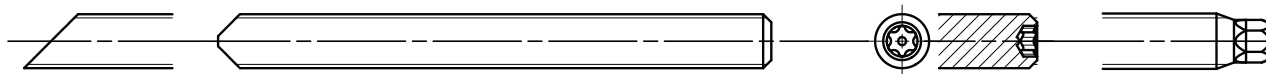

spherical washer

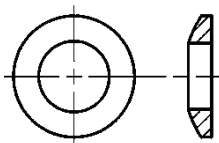

conical washer (various versions; partly fillable)

without drill hole

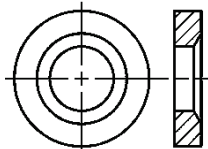

radial

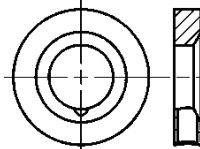

angular

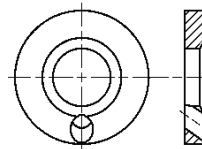

axial

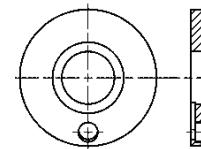

centering sleeve (only push through installation)

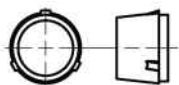

washer

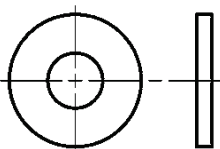

hexagonal nut with spherical contact surface

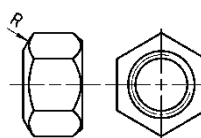

hexagon nut

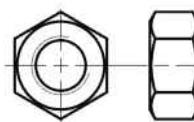

lock nut



Injection adapter

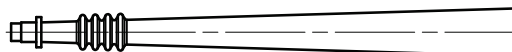

Cleaning brush BS



Compressed-air cleaning tool ABP



Figures not to scale

fischer FIS EM Plus dynamic

System description

Overview system components part 2;
Steel components / injection adapter / cleaning brush / Compressed-air cleaning tool

Annex A3

Appendix 5 / 19

Table A4.1: Materials

Part	Designation	Material	
1	Injection cartridge	Mortar, hardener, filler	
	Steel grade	Steel	Stainless steel R
		zinc plated	acc. to EN 10088-1:2023 Corrosion resistance class CRC III acc. to EN 1993-1-4:2006+A1:2015
2	fischer anchor rod FIS A or RG M	Property class 8.8; EN ISO 898-1:2013 zinc plated $\geq 5 \mu\text{m}$ EN ISO 4042:2022 $f_{uk} \leq 1000 \text{ N/mm}^2$	Property class 70 EN ISO 3506-1:2020 1.4401 (M12 to M24) 1.4062 (M12 and M16) 1.4362 (M12 and M16) EN 10088-1:2023 $f_{uk} \leq 1000 \text{ N/mm}^2$
3	Centering sleeve	Plastic	
4a	Washer ISO 7089:2000	---	1.4401; 1.4404; 1.4578; 1.4571; 1.4439; 1.4362; EN 10088-1:2023
4b	Fillable conical washer similar to DIN 6319-G	zinc plated $\geq 5 \mu\text{m}$, EN ISO 4042: 2022	1.4401; 1.4404; 1.4578; 1.4571; 1.4439; 1.4362; EN 10088-1:2023
5	Spherical washer	zinc plated $\geq 5 \mu\text{m}$, EN ISO 4042: 2022	1.4401; 1.4404; 1.4578; 1.4571; 1.4439; 1.4362; EN 10088-1:2023
6a	Hexagon nut	Property class 8; EN ISO 898-2:2022 zinc plated $\geq 5 \mu\text{m}$, EN ISO 4042: 2022	Property class 80 EN ISO 3506-1:2020 1.4401; 1.4404; 1.4578; 1.4571; 1.4439; 1.4362; EN 10088-1:2023
6b	Hexagonal nut with spherical contact surface		
7	Lock nut	zinc plated $\geq 5 \mu\text{m}$, EN ISO 4042: 2022	1.4401; 1.4404; 1.4578; 1.4571; 1.4439; 1.4362; EN 10088-1:2023

fischer FIS EM Plus dynamic





Product description
Materials

Annex A4

Appendix 6 / 19

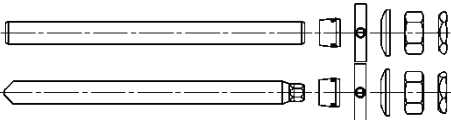
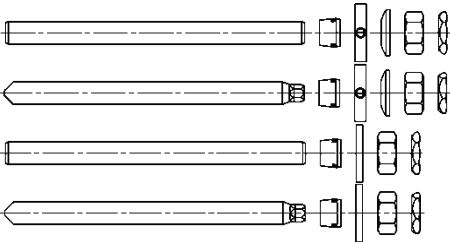
Specifications of intended use part 1

Table B1.1: Overview use and performance categories injection mortar system

		FIS EM Plus with	
		fischer anchor rod FIS A or fischer anchor rod RG M	
		Steel, zinc plated M12 + M16	Stainless steel R M12 - M24
			
Hammer drilling with standard drill bit		Nominal drill bit diameter (d_0) 14 mm to 18 mm	Nominal drill bit diameter (d_0) 14 mm to 28 mm
Hammer drilling with hollow drill bit (fischer "FHD", Heller "Duster Expert"; Bosch "Speed Clean"; Hilti "TE-CD, TE-YD"; DreBo „D-Plus“; DreBo „D-Max“)			
Diamond drilling		no performance assessed	
Fatigue load, in	<div style="display: flex; justify-content: space-around;"> <div>uncracked concrete</div> <div>cracked concrete</div> </div>	Steel, zinc plated: M12 and M16	Stainless steel R: M12, M16, M20 and M24
Design method I acc. to EOTA TR 061:2023	$n = 1$ to $n = \infty$		
Design method II acc. to EOTA TR 061:2023	$n = \infty$		
Use category I1 dry or wet concrete	M12, M16, M20 and M24		
Installation direction	D3 Downwards, horizontal and upwards (overhead) installation		
Installation method	pre-positioned or push through installation		
Installation temperature	FIS EM Plus: $T_{i,min} = -5\text{ °C}$ to $T_{i,max} = +40\text{ °C}$		
In-service temperature	Temperature range I:	-40 °C to +40 °C	(max. short term temperature +40 °C; max. long term temperature +24 °C)
	Temperature range II:	-40 °C to +60 °C	(max. short term temperature +60 °C; max. long term temperature +35 °C)
	Temperature range III:	-40 °C to +72 °C	(max. short term temperature +72 °C; max. long term temperature +50 °C)

fischer FIS EM Plus dynamic

Intended use
Specifications part 1

Annex B1

Appendix 7 / 19

Specifications of intended use part 2

Base materials:

- Compacted reinforced or unreinforced normal weight concrete without fibers of strength classes C20/25 to C50/60 according to EN 206:2013+A2:2021.

Use conditions (Environmental conditions):

- Structures subject to dry internal conditions (zinc plated steel, stainless steel R).
- For all other conditions according to EN 1993-1-4:2006+A1:2015 corresponding to corrosion resistance classes to Annex A4 Table A4.1.

Design:

- Fastenings have to be designed by a responsible engineer with experience of concrete anchor design.
- Verifiable calculation notes and drawings are to be prepared taking account of the loads to be anchored. The position of the anchor is indicated on the design drawings (e. g. position of the anchor relative to reinforcement or to supports, etc.).
- Anchorages have to be designed in accordance with:
 - EN 1992-4:2018 and
 - EOTA Technical Report TR 061 "Design method for fasteners in concrete under fatigue cyclic loading", Edition 2023.
- Static and quasi-static loading see ETA-17/0979 of 16.12.2025.
- Fastenings shall be positioned outside of critical regions (e.g. plastic hinges) of the concrete structure.
- Fastenings in stand-off installation or with a grout layer are not covered by this European Technical Assessment (ETA).

Installation:

- Anchor installation is to be carried out by appropriately qualified personnel and under the supervision of the person responsible for technical matters of the site.
- In case of aborted hole: The hole shall be filled with mortar.
- Fastening depth should be marked and adhered to on installation.
- If only tension loads are involved in the application, the annular gap does not need to be filled.
- Overhead installation is allowed.
- Setting the fastener with clearance between concrete and anchor plate (only if the fastener is loaded in axial direction)

fischer FIS EM Plus dynamic

Intended use
Specifications part 2

Annex B2

Appendix 8 / 19

Table B3.1: Installation parameters for fischer anchor rods in combination with injection mortar system FIS EM Plus

fischer anchor rods		Thread	M12	M16	M20	M24
Material			zinc plated steel or stainless steel R		stainless steel R	
Nominal drill hole diameter	d_0	[mm]	14	18	24	28
Drill hole depth	h_0		$h_0 = h_{ef}$			
Effective embedment depth Design method I	$h_{ef, min}$ $h_{ef, max}$		70 240	80 320	90 400	96 480
Effective embedment depth Design method II	$h_{ef, min}$ $h_{ef, max}$		95 240	125 320	160 400	190 480
Minimum spacing and minimum edge distance	S_{min} = C_{min}		55	65	85	105
Diameter of the clearance hole of the fixture	pre-positioned installation d_f		14-16	18-20	22-26	26-30
	push through installation d_f		15-16	19-20	25-26	29-30
Fixture thickness	$t_{fix, min}$		6	8	10	12
	$t_{fix, max}$		200			
Minimum thickness of concrete member	h_{min}		$h_{ef} + 30$	$h_{ef} + 2d_0$	$h_{ef} + 2d_0$	$h_{ef} + 2d_0$
Installation with dynamic set						
Protrusion anchor rod FIS A or RG M without hexagon head	$h_{p, min}$	[mm]	$25 + t_{fix}$	$30 + t_{fix}$	$36 + t_{fix}$	$43 + t_{fix}$
Protrusion anchor rod RG M (with hexagon head)	$h_{p, min}$		$32 + t_{fix}$	$38 + t_{fix}$	$43 + t_{fix}$	---
Installation with washer (only with stainless steel R)						
Protrusion anchor rod FIS A or RG M without hexagon head	$h_{p2, min}$	[mm]	$19 + t_{fix}$	$23 + t_{fix}$	$27 + t_{fix}$	$32 + t_{fix}$
Protrusion anchor rod RG M (with hexagon head)	$h_{p2, min}$		$26 + t_{fix}$	$31 + t_{fix}$	$34 + t_{fix}$	---
Required installation torque	T_{inst}	[Nm]	40	60	120	150

fischer anchor rod FIS A or RG M

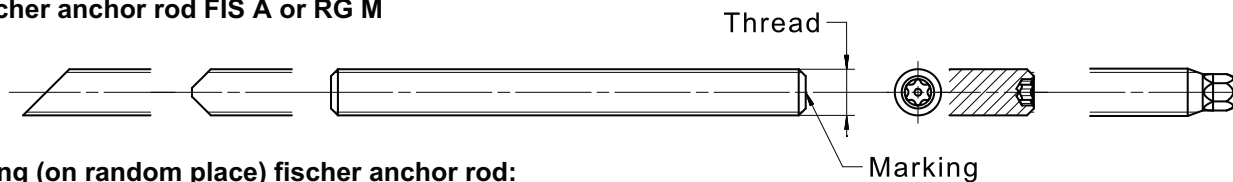

Marking (on random place) fischer anchor rod:

Property class 8.8: +

Installation conditions see Annex B4

Figures not to scale

fischer FIS EM Plus dynamic

Intended use

Installation parameters fischer anchor rods FIS A and RG M in combination with injection mortar system FIS EM Plus

Annex B3

Appendix 9 / 19

Installation conditions FIS A or RG M with dynamic set or washer with centering sleeve

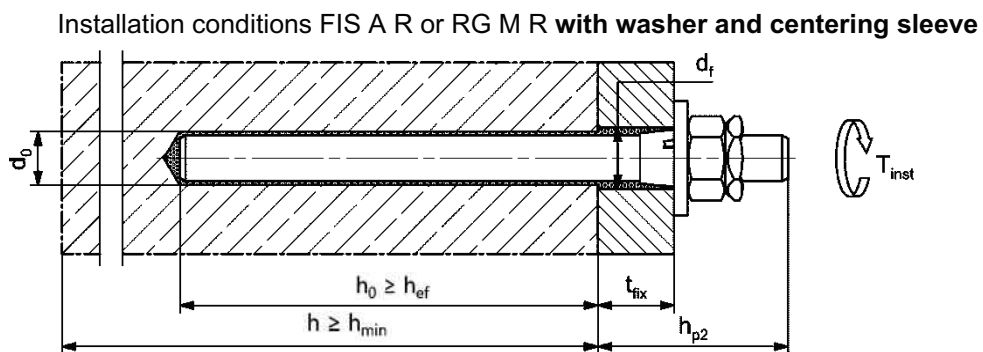
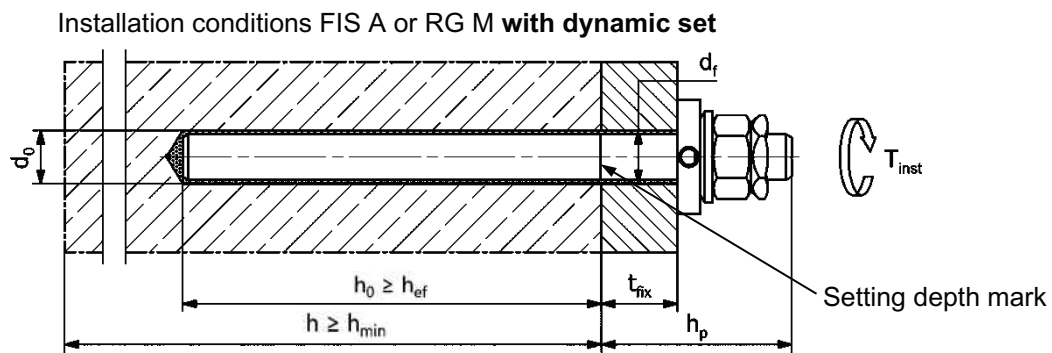

Figures not to scale

fischer FIS EM Plus dynamic

Intended use

Installation conditions FIS A or RG M with dynamic set or washer with centering sleeve

Annex B4

Appendix 10 / 19

Table B5.1: Parameters of the cleaning brush BS (steel brush with steel bristles)
The size of the cleaning brush refers to the drill hole diameter

Nominal drill hole diameter	d_0	[mm]	14	18	24	28
Steel brush diameter	d_b		16	20	26	30

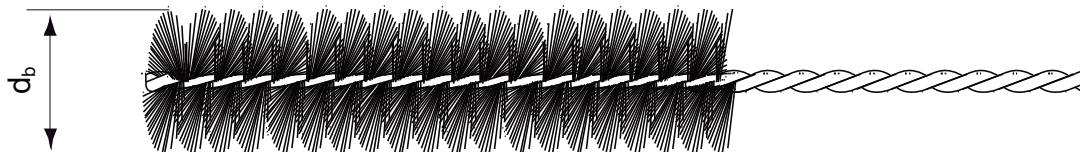

Table B5.2: Conditions for use **static mixer** without an **extension tube**

Nominal drill hole diameter	d_0	[mm]	14	18	24	28
Drill hole depth h_0 by using	FIS MR Plus	[mm]	≤ 120	≤ 150	≤ 190	≤ 210
	FIS UMR	[mm]	≤ 90	≤ 180	≤ 220	≤ 250

Table B5.3: **Maximum processing time** of the mortar and **minimum curing time**

During the curing time of the mortar the concrete temperature may not fall below the listed minimum temperature.

Temperature at anchoring base [°C]	Maximum processing time t_{work}	Minimum curing time ¹⁾ t_{cure}
> -5 to ± 0 ²⁾	240 min	200 h
> ± 0 to +5 ²⁾	150 min	90 h
> +5 to +10	120 min	40 h
> +10 to +20	30 min	18 h
> +20 to +30	14 min	10 h
> +30 to +40	7 min	5 h

¹⁾ In wet concrete the curing times must be doubled

²⁾ Minimal cartridge temperature +5°C

fischer FIS EM Plus dynamic

Intended use





Cleaning brush (steel brush)
Processing time and curing time

Annex B5

Appendix 11 / 19

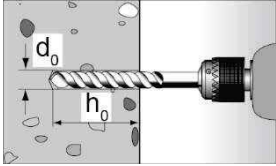
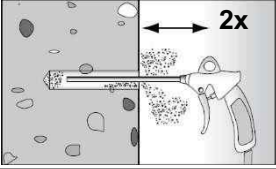
Installation instructions part 1; injection mortar system FIS EM Plus

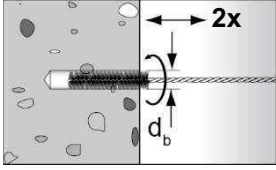
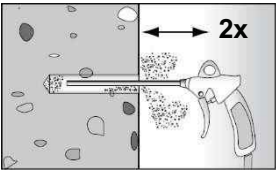
Drilling and cleaning the hole (hammer drilling with standard drill bit)

1		<p>Drill the hole. Nominal drill hole diameter d_0 and drill hole depth h_0 see Table B3.1.</p>
2		<p>Cleaning the drill hole: Blow out the drill hole twice, with oil free compressed air ($p \geq 6$ bar).</p> 
3		<p>Brush the drill hole twice. For drill hole diameter ≥ 30 mm use a power drill. For deep holes use an extension. Corresponding brushes see Table B5.1.</p>
4		<p>Cleaning the drill hole: Blow out the drill hole twice, with oil free compressed air ($p \geq 6$ bar).</p> 

Go to step 5 **Annex B7**

Drilling and cleaning the hole (hammer drilling with hollow drill bit)

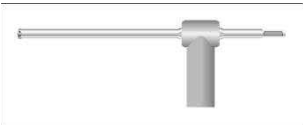
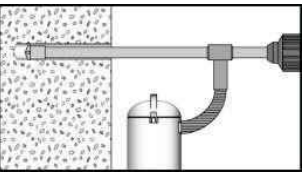
1		<p>Check a suitable hollow drill (see Table B1.1) for correct operation of the dust extraction.</p>
2		<p>Use a suitable dust extraction system, e. g. fischer FVC 35 M or a comparable dust extraction system with equivalent performance data.</p> <p>Drill the hole with hollow drill bit. The dust extraction system has to extract the drill dust nonstop during the drilling process and must be adjusted to maximum power. Nominal drill hole diameter d_0 and drill hole depth h_0 see Table B3.1.</p>

Go to step 5 **Annex B7**.

fischer FIS EM Plus dynamic

Intended use



Installation instructions part 1; injection mortar system FIS EM Plus

Annex B6

Appendix 12 / 19

Installation instructions part 2; injection mortar system FIS EM Plus

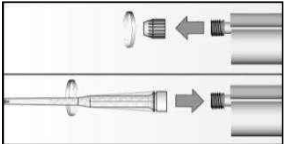
Preparing the cartridge

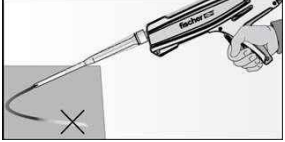
5		<p>Remove the sealing cap. Screw on the static mixer (the spiral in the static mixer must be clearly visible).</p>
6		<p>Place the cartridge into the dispenser.</p> <p>When using the foilbag, the foil container holder must be used.</p>
7		<p>Extrude approximately 10 cm of material out until the resin is evenly grey in colour. Do not use mortar that is not uniformly grey.</p>

Go to step 8 (Pre-positioned installation **Annex B8** or push through installation **Annex B9**).

fischer FIS EM Plus dynamic



Intended use
Installation instructions part 2; injection mortar system FIS EM Plus

Annex B7

Appendix 13 / 19

Installation instructions part 3, injection mortar system FIS EM Plus

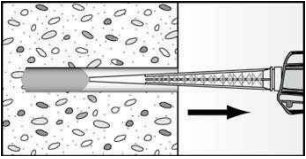
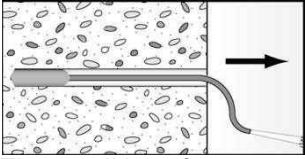
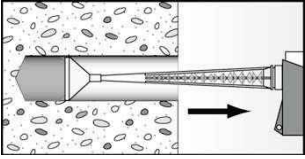
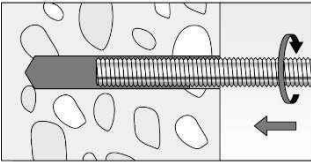
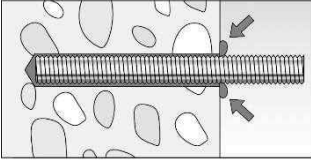
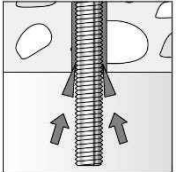
Pre-positioned installation

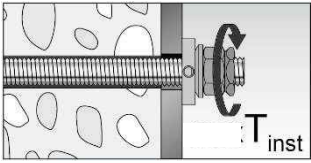
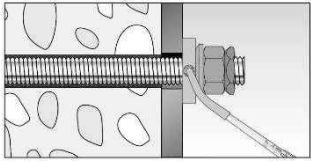
<p>8</p>	 <p>Fill approximately 2/3 of the drill hole with mortar. Always begin from the bottom of the hole and avoid bubbles.</p>	 <p>The conditions for mortar injection without extension tube can be found in Table B5.2 For deeper drill holes, than those mentioned in Table B5.2, use a suitable extension tube.</p>	 <p>For overhead installation or deep holes ($h_0 > 250\text{mm}$) use an injection-adapter.</p>
<p>9</p>	   <p>Only use clean and oil-free metal parts. Mark the setting depth of the anchor rod. Push the fischer anchor rod down to the bottom of the hole, turning it slightly while doing so.</p> <p>After inserting the anchor rod, excess mortar must be emerged around the anchor element. If not, pull out the anchor element immediately and reinject mortar.</p> <p>For overhead installations support the anchor rod with wedges (e.g. fischer centering wedges) until the mortar begins to harden.</p>		
<p>10</p>		<p>Wait for the specified curing time t_{cure} see Table B5.3.</p>	
<p>11</p>		<p>Attach the component and install the washer and nuts - without centering sleeve. Tighten the hexagon nut with torque wrench, T_{inst} see Table B3.1. Tighten lock nut manually, then use wrench to give another quarter or half turn.</p>	
<p>12</p>		<p>The gap between anchor and fixture (annular clearance) has to be filled with mortar (FIS HB, FIS SB, FIS V Plus or FIS EM Plus) via the fillable conical washer. If only tension loads are involved in the application, the annular gap does not necessarily have to be filled.</p>	

fischer FIS EM Plus dynamic

Intended use



Installation instructions part 3; pre-positioned installation; injection mortar system FIS EM Plus

Annex B8

Appendix 14 / 19

Installation instructions part 4, injection mortar system FIS EM Plus

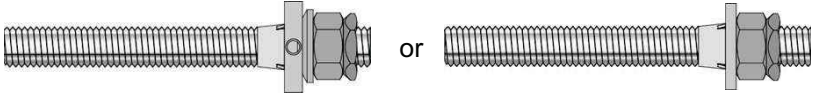
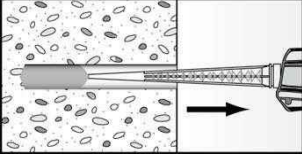
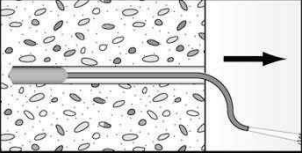
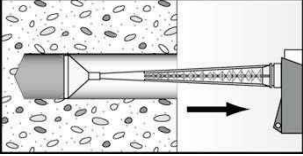
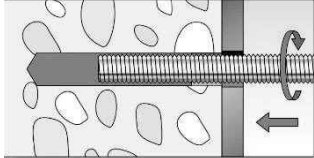
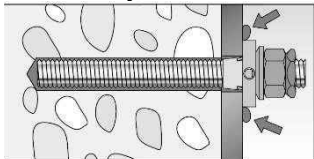
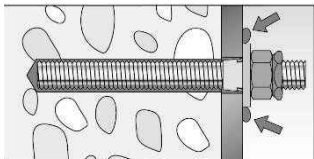
Push through installation

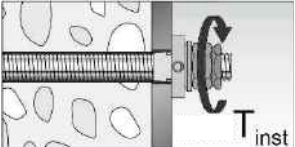
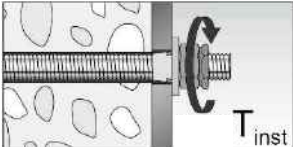
8		<p>Pre-assemble the anchor! (Position of the conical washer or washer = embedment depth + fixture thickness)</p>	
9			
		<p>Only use clean and oil-free metal parts. Push the pre-assembled Fischer anchor rod into the drill hole until the conical washer or washer is in full contact with the surface, turning it slightly while doing so.</p>	
10	<p>with dynamic set:</p>  <p>with washer:</p> 	<p>After inserting the anchor rod with pre-assembled components, excess mortar must be emerged around the anchor element (minimum on one point of the conical washer or washer). If not, pull out the anchor element immediately and reinject mortar.</p>	
11		<p>Wait for the specified curing time t_{cure} see Table B5.3.</p>	
12	<p>with dynamic set:</p>  <p>with washer:</p> 	<p>Tighten the hexagon nut with torque wrench, T_{inst} see Table B3.1. Tighten lock nut manually, then use wrench to give another quarter or half turn.</p>	

fischer FIS EM Plus dynamic

Intended use

Installation instructions part 4; push through installation; injection mortar system FIS EM Plus

Annex B9

Appendix 15 / 19

Table C1.1: Essential characteristics under tension fatigue loading for FIS EM Plus;
Design method I according to TR 061

Required evidence				
Number of load cycles (n)				
$n \leq 10^4$	$10^4 < n \leq 5 \cdot 10^6$	$5 \cdot 10^6 < n \leq 10^8$	$n > 10^8$	
Tension loading				
Characteristic steel fatigue resistance (zinc plated steel 8.8)				
$\Delta N_{Rk,s,0,n}$ (8.8) [kN]				
$0,75 \cdot N_{Rk,s,(8.8)} \cdot 0,33$	$0,75 \cdot N_{Rk,s,(8.8)} \cdot 10^{(-0,12 \cdot \log(n))}$ $\leq 0,75 \cdot N_{Rk,s,(8.8)} \cdot 0,33$	$0,75 \cdot N_{Rk,s,(8.8)} \cdot 10^{(-0,438 - 0,057 \cdot \log(n))}$	$0,75 \cdot N_{Rk,s,(8.8)} \cdot 0,12$	
Characteristic steel fatigue resistance (stainless steel R, property class 70)				
$\Delta N_{Rk,s,0,n}$ (R-70) [kN]				
$0,75 \cdot N_{Rk,s,(R-70)} \cdot 0,33$	$0,75 \cdot N_{Rk,s,(R-70)} \cdot 10^{(-0,16 - 0,09 \cdot \log(n))}$	$0,75 \cdot N_{Rk,s,(R-70)} \cdot 10^{(-0,469 - 0,043 \cdot \log(n))}$	$0,75 \cdot N_{Rk,s,(R-70)} \cdot 0,15$	
Characteristic combined pull-out / concrete cone fatigue resistance, in uncracked and cracked concrete				
Characteristic bond strength in uncracked concrete				
$\Delta \tau_{Rk,p,ucr,0,n}$ [N/mm ²]				
$\tau_{Rk,ucr} \cdot 0,575$	$\tau_{Rk,ucr} \cdot 10^{(-0,06 \cdot \log(n))}$	$\tau_{Rk,ucr} \cdot 10^{(-0,207 - 0,029 \cdot \log(n))}$	$\tau_{Rk,ucr} \cdot 0,35$	
Characteristic bond strength in cracked concrete				
$\Delta \tau_{Rk,p,cr,0,n}$ [N/mm ²]				
$\tau_{Rk,cr} \cdot 0,575$	$\tau_{Rk,cr} \cdot 10^{(-0,06 \cdot \log(n))}$	$\tau_{Rk,cr} \cdot 10^{(-0,207 - 0,029 \cdot \log(n))}$	$\tau_{Rk,cr} \cdot 0,35$	
Characteristic concrete cone and splitting fatigue resistance				
Characteristic concrete fatigue resistance in uncracked concrete				
$\Delta N_{Rk,c/sp,ucr,0,n}$ [kN]				
$N_{Rk,c/sp,ucr} \cdot 0,66$	$N_{Rk,c/sp,ucr} \cdot 1,1 \cdot n^{-0,055} \geq N_{Rk,c/sp,ucr} \cdot 0,50$			$N_{Rk,c/sp,ucr} \cdot 0,50$
Characteristic concrete fatigue resistance in cracked concrete				
$\Delta N_{Rk,c/sp,cr,0,n}$ [kN]				
$N_{Rk,c/sp,cr} \cdot 0,66$	$N_{Rk,c/sp,cr} \cdot 1,1 \cdot n^{-0,055} \geq N_{Rk,c/sp,cr} \cdot 0,50$			$N_{Rk,c/sp,cr} \cdot 0,50$
Exponents and load transfer factor				
Exponent for combined loading				
	M12	M16	M20	M24
$\alpha_s = \alpha_{sn}$ [-]	0,5		0,7	
Load transfer factor				
ψ_{FN} [-]	0,5			
$N_{Rk,s}$, $\tau_{Rk,ucr}$, $\tau_{Rk,cr}$ see ETA-17/0979 of 16.12.2025, for τ_{Rk} (M24-R-70) $\leq 0,85 \cdot \tau_{Rk}$ (M20-R-70) $N_{Rk,c/sp,ucr}$, $N_{Rk,c/sp,cr}$ see ETA-17/0979 of 16.12.2025 and EN 1992-4:2018				
fischer FIS EM Plus dynamic				Annex C1 Appendix 16 / 19
Performance Essential characteristics under tension fatigue loading; Design method I according to TR 061				

Table C2.1: Essential characteristics under shear fatigue loading for FIS EM Plus;
Design method I according to TR 061

Required evidence				
Number of load cycles (n)				
$n \leq 10^4$	$10^4 < n \leq 5 \cdot 10^6$	$5 \cdot 10^6 < n \leq 10^8$	$n > 10^8$	
Shear loading				
Characteristic steel fatigue resistance (zinc plated steel 8.8)				
$\Delta V_{Rk,s,0,n}$ (8.8) [kN]				
$V_{Rk,s,(8.8)} \cdot 0,23$	$V_{Rk,s,(8.8)} \cdot 10^{(-0,147 \cdot \log(n))}$ $\leq V_{Rk,s,(8.8)} \cdot 0,23$	$V_{Rk,s,(8.8)} \cdot 10^{(-0,573 - 0,068 \cdot \log(n))}$ $\geq V_{Rk,s,(8.8)} \cdot 0,08$	$V_{Rk,s,(8.8)} \cdot 0,08$	
Characteristic steel fatigue resistance (stainless steel R, property class 70)				
$\Delta V_{Rk,s,0,n}$ (R-70) [kN]				
$V_{Rk,s,(R-70)} \cdot 0,31$	$V_{Rk,s,(R-70)} \cdot 10^{(-0,042 - 0,118 \cdot \log(n))}$	$V_{Rk,s,(R-70)} \cdot 10^{(-0,461 - 0,056 \cdot \log(n))}$	$V_{Rk,s,(R-70)} \cdot 0,12$	
Characteristic concrete pry out fatigue resistance in cracked and uncracked concrete				
$\Delta V_{Rk,cp,0,n}$ [kN]				
$V_{Rk,cp} \cdot 0,574$	$V_{Rk,cp} \cdot 1,2 \cdot n^{-0,08} \geq V_{Rk,cp} \cdot 0,50$			$V_{Rk,cp} \cdot 0,50$
Characteristic concrete edge fatigue resistance in cracked and uncracked concrete				
$\Delta V_{Rk,c,0,n}$ [kN]				
$V_{Rk,c} \cdot 0,574$	$V_{Rk,c} \cdot 1,2 \cdot n^{-0,08} \geq V_{Rk,c} \cdot 0,50$			$V_{Rk,c} \cdot 0,50$
Exponents, load transfer factor				
Exponent for combined loading, steel failure				
	M12	M16	M20	M24
$\alpha_s = \alpha_{sn}$	[-]	0,5	0,7	
Exponent for combined loading, verification regarding failure modes other than steel failure				
α_c	[-]	1,5		
Load transfer factor				
ψ_{FV}	[-]	0,5		
$V_{Rk,s}$ see ETA-17/0979 of 16.12.2025 $V_{Rk,c}, V_{Rk,cp}$ see ETA-17/0979 of 16.12.2025 and EN 1992-4:2018				
fischer FIS EM Plus dynamic				Annex C2 Appendix 17 / 19
Performance Essential characteristics under shear fatigue loading; Design method I according to TR 061				

Table C3.1: Essential characteristics under tension and shear fatigue loading; Design method II according to TR 061; zinc plated steel 8.8

Size			M12	M16
Tension loading				
Effective embedment depth	$h_{ef,min}$	[mm]	95	125
Steel failure				
Characteristic steel fatigue resistance	$\Delta N_{Rk,s,0,\infty}$	[kN]	6,1	11,3
Exponent for combined loading	$\alpha_s = \alpha_{sn}$	[-]	0,5	0,7
Combined pull-out / concrete cone failure				
Characteristic bond fatigue resistance	$\Delta \tau_{Rk,p,ucr,0,\infty}$	[N/mm ²]	$\tau_{Rk,ucr} \cdot 0,35$	
	$\Delta \tau_{Rk,p,cr,0,\infty}$	[N/mm ²]	$\tau_{Rk,cr} \cdot 0,35$	
Concrete cone failure and concrete splitting failure				
Characteristic concrete fatigue resistance	$\Delta N_{Rk,c,0,\infty}$	[-]	$0,5 \cdot N_{Rk,c}^{1)}$	
	$\Delta N_{Rk,sp,0,\infty}$	[-]	$0,5 \cdot N_{Rk,sp}^{1)}$	
Exponent for combined loading	α_c	[-]	1,5	
Load transfer factor	Ψ_{FN}	[-]	0,5	
Shear loading				
Shear loading, steel failure without lever arm				
Characteristic steel fatigue resistance	$\Delta V_{Rk,s,0,\infty}$	[kN]	2,7	5,0
Exponent for combined loading	$\alpha_s = \alpha_{sn}$	[-]	0,5	0,7
Concrete pryout failure				
Characteristic concrete fatigue resistance	$\Delta V_{Rk,cp,0,\infty}$	[kN]	$0,5 \cdot V_{Rk,cp}^{1)}$	
Concrete edge failure				
Characteristic concrete fatigue resistance	$\Delta V_{Rk,c,0,\infty}$	[kN]	$0,5 \cdot V_{Rk,c}^{1)}$	
Effective length of fastener	l_f	[mm]	$\min(h_{ef}, 12 \cdot d_{nom})$	
Effective outside diameter of the anchor	d_{nom}	[mm]	12	16
Exponent for combined loading	α_c	[-]	1,5	
Load transfer factor	Ψ_{FV}	[-]	0,5	

¹⁾ $N_{Rk,c}$, $N_{Rk,sp}$, $V_{Rk,c}$ and $V_{Rk,cp}$ – Essential characteristics for concrete failure under static and quasi-static loading according to ETA-17/0979 of 16.12.2025 and EN 1992-4:2018.

fischer FIS EM Plus dynamic

Performance

Essential characteristics under tension / shear fatigue loading; Design method II according to TR 061; zinc plated steel 8.8

Annex C3

Appendix 18 / 19

Table C4.1: Essential characteristics under tension and shear fatigue loading;
Design method II according to TR 061; stainless steel R property class 70

Size			M12	M16	M20	M24
Tension loading						
Effective embedment depth	$h_{ef,min}$	[mm]	95	125	160	190
Steel failure						
Characteristic steel fatigue resistance	$\Delta N_{Rk,s,0,\infty}$	[kN]	6,6	12,4	19,4	27,8
Exponent for combined loading	$\alpha_s = \alpha_{sn}$	[-]	0,5	0,7		
Combined pull-out / concrete cone failure						
Characteristic bond fatigue resistance	$\Delta \tau_{Rk,p,ucr,0,\infty}$	[N/mm ²]	$\tau_{Rk,ucr} \cdot 0,35$			
	$\Delta \tau_{Rk,p,cr,0,\infty}$	[N/mm ²]	$\tau_{Rk,cr} \cdot 0,35$			
Concrete cone failure and concrete splitting failure						
Characteristic concrete fatigue resistance	$\Delta N_{Rk,c,0,\infty}$	[-]	$0,5 \cdot N_{Rk,c}^{1)}$			
	$\Delta N_{Rk,sp,0,\infty}$	[-]	$0,5 \cdot N_{Rk,sp}^{1)}$			
Exponent for combined loading	α_c	[-]	1,5			
Load transfer factor	Ψ_{FN}	[-]	0,5			
Shear loading						
Shear loading, steel failure without lever arm						
Characteristic steel fatigue resistance	$\Delta V_{Rk,s,0,\infty}$	[kN]	3,6	6,6	10,3	14,9
Exponent for combined loading	$\alpha_s = \alpha_{sn}$	[-]	0,5	0,7		
Concrete pryout failure						
Characteristic concrete fatigue resistance	$\Delta V_{Rk,cp,0,\infty}$	[kN]	$0,5 \cdot V_{Rk,cp}^{1)}$			
Concrete edge failure						
Characteristic concrete fatigue resistance	$\Delta V_{Rk,c,0,\infty}$	[kN]	$0,5 \cdot V_{Rk,c}^{1)}$			
Effective length of fastener	l_f	[mm]	$\min(h_{ef}, 12 \cdot d_{nom})$			
Effective outside diameter of the anchor	d_{nom}	[mm]	12	16	20	24
Exponent for combined loading	α_c	[-]	1,5			
Load transfer factor	Ψ_{FV}	[-]	0,5			

¹⁾ $N_{Rk,c}$, $N_{Rk,sp}$, $V_{Rk,c}$ and $V_{Rk,cp}$ – Essential characteristics for concrete failure under static and quasi-static loading according to ETA-17/0979 of 16.12.2025 and EN 1992-4:2018, for $\tau_{Rk}(M24-R-70) \leq 0,85 \cdot \tau_{Rk}(M20-R-70)$

fischer FIS EM Plus dynamic

Performance

Essential characteristics under tension / shear fatigue loading;
 Design method II according to TR 061; stainless steel R property class 70

Annex C4

Appendix 19 / 19