



DÉCLARATION DES PERFORMANCES

DoP 0267

pour Clou fischer FDN II (fixation mécanique pour utilisation dans le béton)

FR

1. Code d'identification unique du type de produit: DoP 0267
2. Usage(s) prévu(s): Fixation dans le béton pour les systèmes redondants non structurels, voir annexes, en particulier les annexes B1 - B2.
3. Fabricant: fischerwerke GmbH & Co. KG, Klaus-Fischer-Str. 1, 72178 Waldachtal, Allemagne
4. Mandataire: -
5. Système(s) d'évaluation et de vérification de la constance des performances: 2+
6. Document d'évaluation européen: ETAG 001, Part 6, April 2013, utilisé en tant que DEE
Evaluation Technique Européenne: ETA-17/0736; 2018-01-30
Organisme d'évaluation technique: DIBt- Deutsches Institut für Bautechnik
Organisme(s) notifié(s): 2873 TU Darmstadt
7. Performance(s) déclarée(s):
Sécurité d'utilisation (BWR 4)
Résistance caractéristique à la charge de traction (charge statique et quasi-statique):
Résistance à la rupture de l'acier: NPD
Résistance à l'extraction glissement: NPD
Résistance à la rupture du cône béton: NPD
Robustesse: Annexe C1
Distance au bord et entraxe mini.: Annexes B2, C1
Distance au bord pour éviter la rupture par fendage sous charge: NPD
Résistance caractéristique à la charge de cisaillement (charge statique et quasi-statique):
Résistance à la rupture de l'acier (charge de cisaillement) : Annexe C1 $V_{Rk,s}=NPD; k_7=NPD$
Résistance à la rupture par effet de levier : NPD
Résistance à la rupture du béton en bord de dalle: NPD
Résistance caractéristique pour toutes les directions de charges et modes de ruine pour dimensionnement simplifié:
Résistance caractéristique: Annexe C1
Durabilité:
Durabilité: Annexe B1
Sécurité en cas d'incendie (BWR 2)
Réaction au feu: Classe (A1)
Résistance au feu:
Résistance en cas d'incendie, rupture de l'acier (charge de traction) : NPD
Résistance en cas d'incendie, extraction glissement (charge de traction) : NPD
Résistance en cas d'incendie, rupture de l'acier (charge de cisaillement) : NPD
Résistance en cas d'incendie pour toutes les directions de charges et modes: Annexe C1
8. Documentation technique appropriée et/ou documentation technique spécifique: -

Les performances du produit identifié ci-dessus sont conformes aux performances déclarées. Conformément au règlement (UE) no 305/2011, la présente déclaration des performances est établie sous la seule responsabilité du fabricant mentionné ci-dessus.

Signé pour le fabricant et en son nom par:

Dr.-Ing. Oliver Geibig, Directeur Général Business Units & Ingénierie
Tumlingen, 2021-01-11

Jürgen Grün, Directeur Général Chimie & Qualité

Cette DoP a été préparée en plusieurs langues. En cas de différend relatif à l'interprétation, la version anglaise prévaudra.

L'annexe comprend des informations volontaires et complémentaires en langue anglaise dépassant les exigences légales (spécifiées de manière neutre).

Specific Part

1 Technical description of the product

The Fischer Ceiling Anchor FDN II is an anchor made of galvanized steel which is placed into a drilled hole and anchored by deformation-controlled expansion.

The product description is given in Annex A.

2 Specification of the intended use in accordance with the applicable European Assessment Document

The performances given in Section 3 are only valid if the anchor is used in compliance with the specifications and conditions given in Annex B.

The verifications and assessment methods on which this European Technical Assessment is based lead to the assumption of a working life of the anchor of at least 50 years. The indications given on the working life cannot be interpreted as a guarantee given by the producer, but are to be regarded only as a means for choosing the right products in relation to the expected economically reasonable working life of the works.

3 Performance of the product and references to the methods used for its assessment

3.1 Mechanical resistance and stability (BWR 1)

The essential characteristics regarding mechanical resistance and stability are included under the Basic Works Requirement Safety in use.

3.2 Safety in case of fire (BWR 2)

Essential characteristic	Performance
Reaction to fire	Anchorage satisfies requirements for Class A1
Resistance to fire	See Annex C 1

3.3 Safety in use (BWR 4)

Essential characteristic	Performance
Characteristic resistance in concrete	See Annex C 1

4 Assessment and verification of constancy of performance (AVCP) system applied, with reference to its legal base

In accordance with guideline for European technical approval ETAG 001, April 2013 used as European Assessment Document (EAD) according to Article 66 Paragraph 3 of Regulation (EU) No 305/2011 the applicable European legal act is: [97/161/EC].

The system to be applied is: 2+

Product installation conditions, product marking and product dimensions

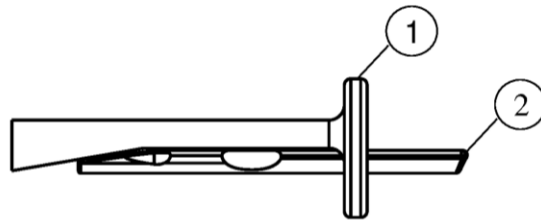

- ① Shaft
- ② Pin

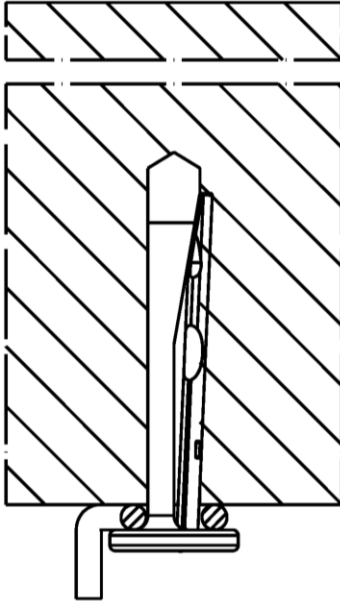

Type of fastener

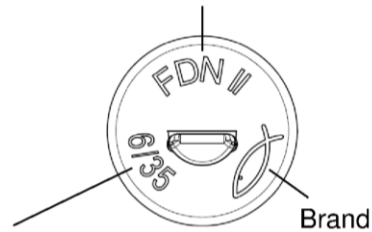

Brand

Nominal diameter / max. thickness of the fixture;
Additional marking "K" for $h_{ef} = 25$ mm

Table A1.1: Dimensions

Size	FDN II			
	6/5 K	6/5	6/35 K	6/35
Length of the $\frac{\text{pin}}{\text{shaft}}$ L_1	36	43	66	73
L_2 [mm]	30,5	37,5	60,5	67,5
Diameter of the head $D \geq$	13			

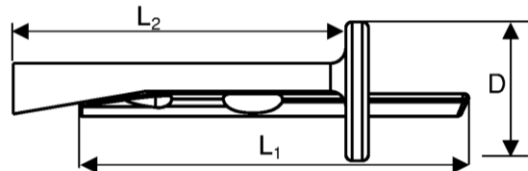

(Fig. not to scale)

fischer Ceiling Anchor FDN II

Product description

Product installation conditions, product marking and product dimensions

Annex A 1

Appendix 2 / 5

Specifications of intended use

Anchorage subject to:

Size	FDN II 6
Static and quasi-static loads	
Use for multiple fixture of non-structural applications according to ETAG 001, Part 6	✓
Fire exposure	

Base materials:

- Reinforced and unreinforced normal weight concrete according to EN 206-1:2000
- Strength classes C12/15 to C50/60 according to EN 206-1:2000
- Cracked and non-cracked concrete

Use conditions (Environmental conditions):

- Anchorage subject to dry internal conditions

Design:

- Anchorages are designed under the responsibility of an engineer experienced in anchorages and concrete work
- Verifiable calculation notes and drawings have to be prepared taking account of the loads to be anchored. The position of the anchor is indicated on the design drawings (e.g. position of the anchor relative to reinforcement or to supports, etc.).
- Anchorages under static or quasi-static actions have to be designed for Design Method C in accordance with:
 - ETAG 001, Annex C, Design Method C, Edition August 2010
 - CEN/TS 1992-4:2009
- Anchorages under fire exposure have to be designed in accordance with
 - EOTA Technical Report TR 020, Edition May 2004
 - CEN/TS 1992-4:2009, Annex D (it must be ensured that local spalling of the concrete cover does not occur)

fischer Ceiling Anchor FDN II

Intended use
Specifications

Annex B 1

Appendix 3 / 5

Table B2.1: Installation parameters

Size		FDN II			
		6/5 K	6/5	6/35 K	6/35
Thickness of the fixture	$t_{fix} \leq$	5		35	
Nominal drill hole diameter	d_0	6			
Diameter of clearance hole in the fixture	$d_f \leq$	7			
Maximum bit diameter	$d_{cut,max}$	6,40			
Effective embedment depth	h_{ef}	25	32	25	32
Depth of drill hole to deepest point	with hole cleaning	30	37	30	37
	without hole cleaning	35	42	35	42
Minimum thickness of concrete member	h_{min}	80			

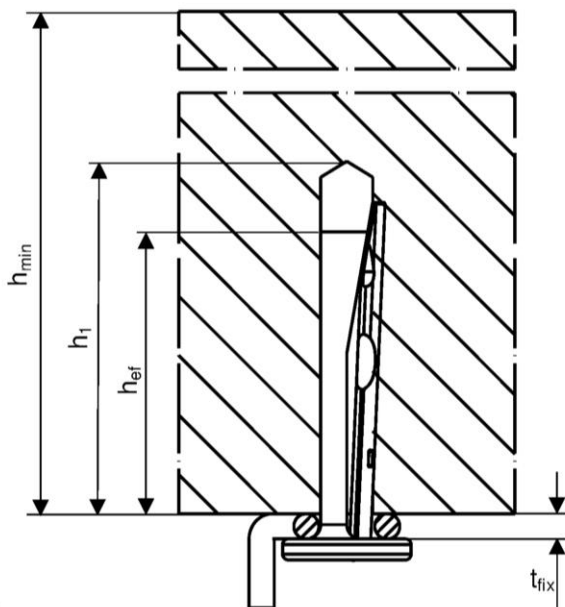

Installation instructions

- Hammer or hollow drilling only
- Anchor installation carried out by appropriately qualified personnel and under the supervision of the person responsible for technical matters of the site
- Positioning of the drill holes without damaging the reinforcement
- In case of aborted hole: New drilling at a minimum distance twice the depth of aborted hole away of or smaller distance if the aborted hole is filled with high strength mortar and if under shear or oblique tension load it is not in the direction of the load application

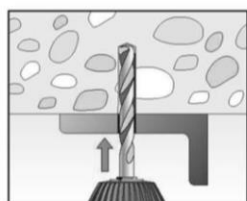

1: Drill the hole

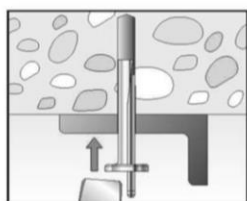

2: Set the fastener

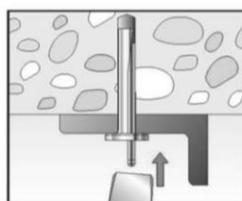

3: Set the pin, until flush to the surface

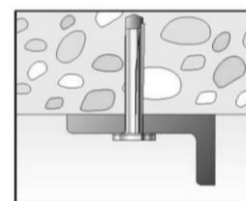

4: Installed fastener

(Fig. not to scale)

fischer Ceiling Anchor FDN II

Intended use

Installation parameters and installation instructions

Annex B 2

Appendix 4 / 5

Table C1.1: Characteristic resistance

Size	FDN II 6	
For all load directions and for all failures modes		
Effective embedment depth	h_{ef} [mm]	25 32
Characteristic resistance in cracked and non-cracked concrete	C12/15	2,0 2,5
	C20/25 to C50/60	2,5 3,5
Characteristic edge distance	$c_{cr,N} = c_{min}$ [mm]	70 60
	spacing	$s_{cr,N} = s_{min}$ [mm]
Partial safety factor	$\gamma_M^{2)}$ [-]	1,5
Shear load with lever arm		
Characteristic bending resistance	$M_{Rk,s}^0$ [Nm]	4,4
Partial safety factor for steel failure	$\gamma_{Ms}^{1)}$ [-]	1,25

¹⁾ In absence of other national regulations

²⁾ The installation safety factor $\gamma_2 = \gamma_{inst} = 1,0$ is included

Table C1.2: Characteristic resistance under fire exposure for all effective embedment depths

Size	FDN II 6	
Steel failure for tension and shear load		
R30	$F_{Rk,s,fi30}$	1,00
R60	$F_{Rk,s,fi60}$	0,50
R90	Characteristic resistance $F_{Rk,s,fi90}$ [kN]	0,34
R120	$F_{Rk,s,fi120}$	0,26
R180	$F_{Rk,s,fi180}$	0,17
Spacing and edge distance		
R30 – R120	$s_{cr,fi}$ [mm]	200
	$c_{cr,fi}$	150

For fire exposure from more than one side $c_{min} \geq 300$ mm

fischer Ceiling Anchor FDN II

Performances

Characteristic resistance and characteristic resistance under fire exposure

Annex C 1