

DÉCLARATION DES PERFORMANCES

DoP 0347

pour fixation pour cadres fischer DuoXpand (Cheville plastique pour l'utilisation dans le béton et la maçonnerie)

FR

1. Code d'identification unique du type de produit: **DoP 0347**
2. Usage(s) prévu(s): **Cheville plastique pour usage multiple dans le béton et la maçonnerie pour applications non structurelles (groupe du matériau support a b, c, d), voir annexes, en particulier les annexes B1 - B5.**
3. Fabricant: **fischerwerke GmbH & Co. KG, Klaus-Fischer-Str. 1, 72178 Waldachtal, Allemagne**
4. Mandataire: **-**
5. Système(s) d'évaluation et de vérification de la constance des performances: **2+**
6. Document d'évaluation européen: **EAD 330284-00-0604-v01, Edition 05/2023**
Evaluation Technique Européenne: **ETA-21/0324; 2023-10-19**
Organisme d'évaluation technique: **DIBt- Deutsches Institut für Bautechnik**
Organisme(s) notifié(s): **2873 TU Darmstadt**
7. Performance(s) déclarée(s):
Sécurité en cas d'incendie (BWR 2)
Réaction au feu: Classe A1
Résistance au feu (groupe du matériau support a): Annexe C3
Résistance au feu (groupes du matériau support b, c et d): Annexe C4

Résistance mécanique et stabilité (BWR 4)
Résistance à la rupture de l'acier sous charge de traction: Annexe C1
Résistance à la rupture de l'acier ou du polymère sous charge de cisaillement: Annexe C1
Résistance à l'extraction glissement ou à la rupture du béton ou à la rupture du polymère sous charge de traction (groupe du matériau support a): Annexe C1
Résistance dans toutes les directions de charge sans bras de levier (groupes du matériau support b, c, d): voir annexes, en particulier les annexes C9 - C15
Distance au bord et entraxe (groupe du matériau support a): Annexe B2
Distance au bord et entraxe (groupes du matériau support b, c, d): Annexes B3, B4
Déplacements sous charge à court et long terme : Annexe C2

Durabilité:
Durabilité: Annexes A3, B1
8. Documentation technique appropriée et/ou documentation technique spécifique: **-**

Les performances du produit identifié ci-dessus sont conformes aux performances déclarées. Conformément au règlement (UE) no 305/2011, la présente déclaration des performances est établie sous la seule responsabilité du fabricant mentionné ci-dessus.

Signé pour le fabricant et en son nom par:



Dr.-Ing. Oliver Geibig, Directeur Général Business Units & Ingénierie
Tumlingen, 2023-11-02



Jürgen Grün, Directeur Général Chimie & Qualité

Cette DoP a été préparée en plusieurs langues. En cas de différend relatif à l'interprétation, la version anglaise prévaudra.

L'annexe comprend des informations volontaires et complémentaires en langue anglaise dépassant les exigences légales (spécifiées de manière neutre).

Translation guidance Essential Characteristics and Performance Parameters for Annexes

Guide de traduction des caractéristiques essentielles et des paramètres de performance pour les annexes

Safety in case of fire (BWR 2)

Sécurité en cas d'incendie (BWR 2)

1	Reaction to fire: Réaction au feu:	-
2	Resistance to fire (base material group a): Résistance au feu (groupe du matériau support a):	$F_{Rk,fi}$ [kN]; $M_{Rk,s,fi}$ [Nm]; $c_{min,fi}$ [mm]
3	Resistance to fire (base material group b, c and d): Résistance au feu (groupe du matériau support a):	$F_{Rk,fi}$ [kN]; $M_{Rk,s,fi}$ [Nm]; $c_{min,fi}$ [mm]

Mechanical resistance and stability (BWR 4)

Résistance mécanique et stabilité (BWR 4)

3	Resistance to steel failure under tension loading: Résistance à la rupture de l'acier sous charge de traction:	$N_{Rk,s}$ [kN]
4	Resistance to steel or polymer failure under shear loading: Résistance à la rupture de l'acier ou du polymère sous charge de cisaillement:	$V_{Rk,s}$ [kN]; $M_{Rk,s}$ [Nm]; $V_{Rk,pol}$ [kN]
5	Resistance to pull-out or concrete failure or polymer failure under tension loading (base material group a) Résistance à l'extraction glissement ou à la rupture du béton ou à la rupture du polymère sous charge de traction (groupe du matériau support a):	$N_{Rk,p}$ [kN] / $N_{Rk,pol}$ [kN]
6	Resistance in any load direction without lever arm (base material group b,c,d): Résistance dans toutes les directions de charge sans bras de levier (groupes du matériau support b, c, d):	F_{Rk} [kN]
7	Edge distance and spacing (base material group a) Distance au bord et entraxe (groupe du matériau support a):	c_{cr} ; s_{cr} ; c_{min} ; s_{min} ; a ; h_{min} [mm]
8	Edge distance and spacing (base material group b,c,d): Distance au bord et entraxe (groupes du matériau support b, c, d):	c_{min} ; s_{min} ; h_{min} [mm]
9	Displacements under short-term and long-term loading: Déplacements sous charge à court et long terme :	δ_0 ; δ_∞ [mm]

Aspects of durability

Durabilité:

10	Durability: Durabilité:	-
----	-----------------------------------	---

Specific part

1 Technical description of the product

The fischer frame fixing DuoXpand 8 and DuoXpand 10 is a plastic anchor consisting of a plastic sleeve made of polyamide and polyoxymethylene and an accompanying specific screw of galvanised steel, of galvanised steel with an additional organic layer or of stainless steel.

The plastic sleeve is expanded by screwing in the specific screw which presses the sleeve against the wall of the drilled hole.

The product description is given in Annex A.

2 Specification of the intended use in accordance with the applicable European Assessment Document

The performances given in Section 3 are only valid if the anchor is used in compliance with the specifications and conditions given in Annex B.

The verifications and assessment methods on which this European Technical Assessment is based lead to the assumption of a working life of the anchors of at least 50 years. The indications given on the working life cannot be interpreted as a guarantee given by the producer, but are to be regarded only as a means for choosing the right products in relation to the expected economically reasonable working life of the works.

3 Performance of the product and references to the methods used for its assessment

3.1 Safety in case of fire (BWR 2)

Essential characteristic	Performance
Reaction to fire	Class A1
Resistance to fire	See Annex C 3 and C 4

3.2 Mechanical resistance and stability (BWR 4)

Essential characteristic	Performance
Resistance to steel failure under tension loading	See Annex C 1
Resistance to steel failure under shear loading	See Annex C 1
Resistance to pull-out or concrete failure under tension loading (base material group a)	See Annex C 1
Resistance in any load direction without lever arm (base material group b, c, d)	See Annexes C 9 – C 15
Edge distance and spacing (base material group a)	See Annex B 2
Edge distance and spacing (base material group b, c, d)	See Annex B 3 and B 4
Displacements under short-term and long-term loading	See Annex C 2

3.3 Aspects of durability linked with the Basic Works Requirements

Essential characteristic	Performance
Durability	See Annex B1

4 Assessment and verification of constancy of performance (AVCP) system applied, with reference to its legal base

In accordance with European Assessment Document EAD 330284-00-0604 the applicable European legal act is: 97/463/EC.

The system to be applied is: 2+

Installed anchor DuoXpand

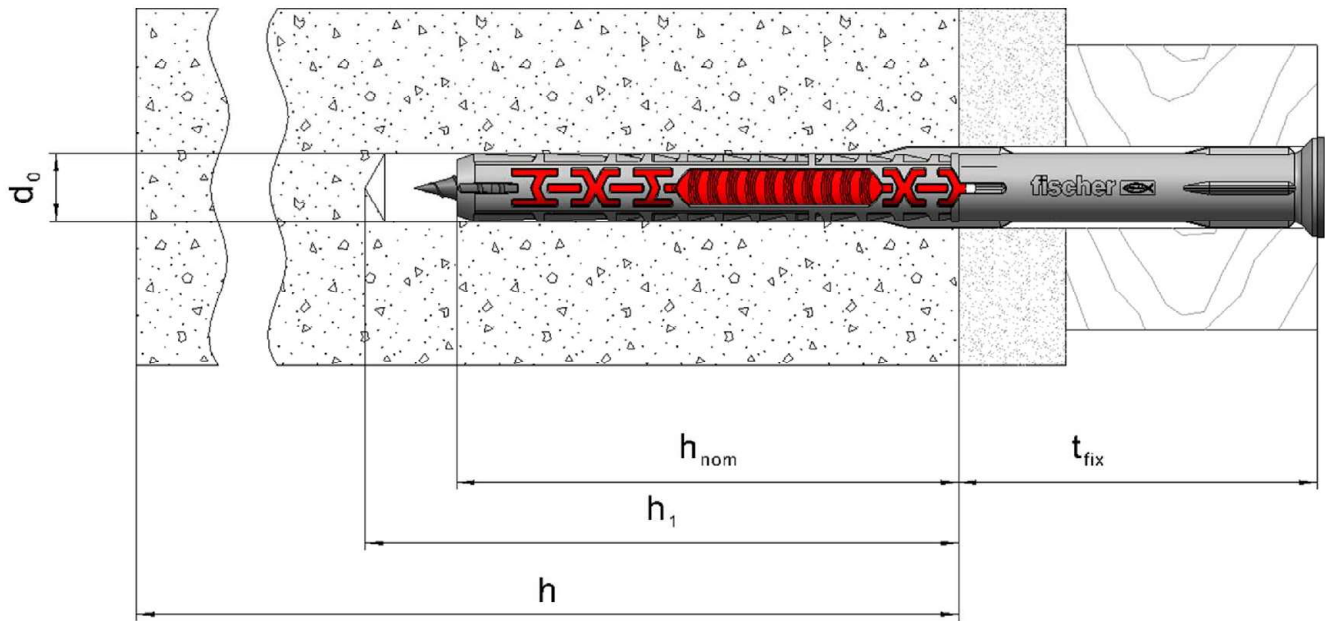

Legend

- d_0 = Nominal drill hole diameter
- h_{nom} = Overall plastic anchor embedment depth in the base material
- h_1 = Depth of drill hole to deepest point
- h = Thickness of member (base material)
- t_{fix} = Thickness of fixture and / or non-load-bearing layer

Figure not to scale

fischer frame fixing DuoXpand

Product description
Installed anchor

Annex A 1

Appendix 3 / 25

Anchor sleeves – flat collar version DuoXpand 8 and 10

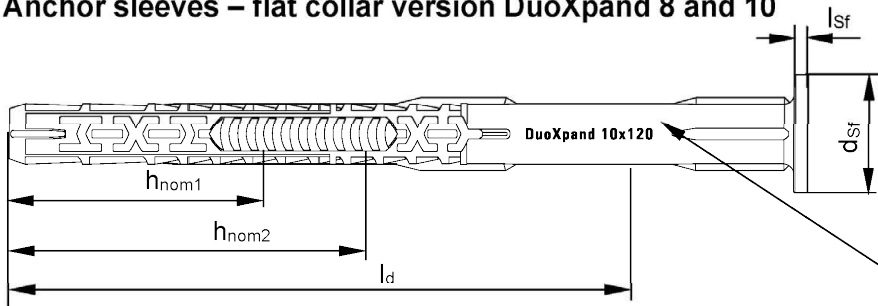

Marking:

Brand

Anchor type

Size

e.g.  DuoXpand 10x120

e.g.  DuoXpand 10x180

Countersunk version DuoXpand 8 and 10

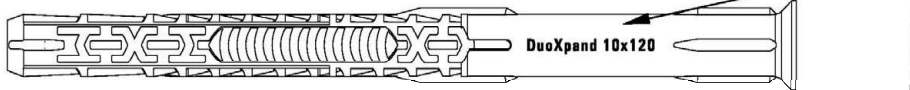

Long version DuoXpand 10 with flat collar – countersunk version also available

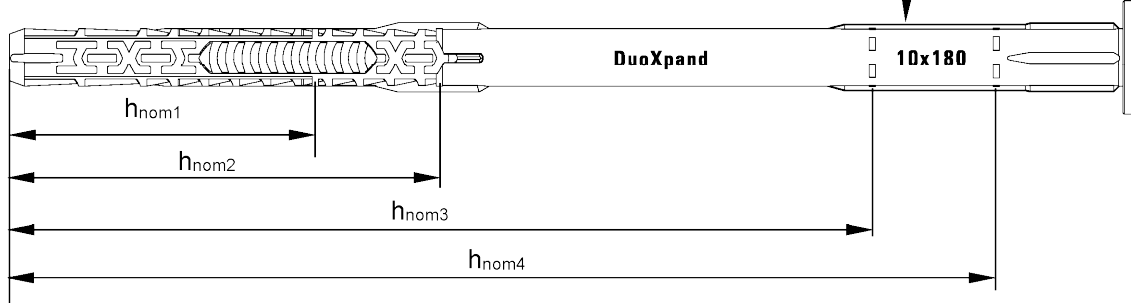

Special screws

Countersunk screw

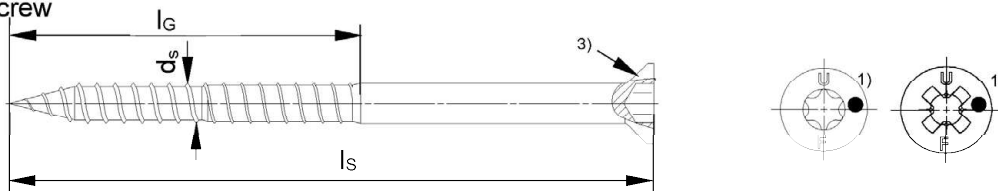

Hexagonal screw with washer

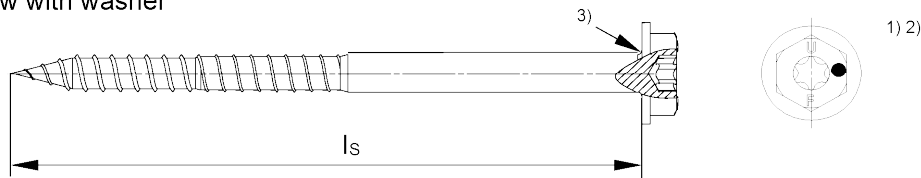

Hexagonal screw

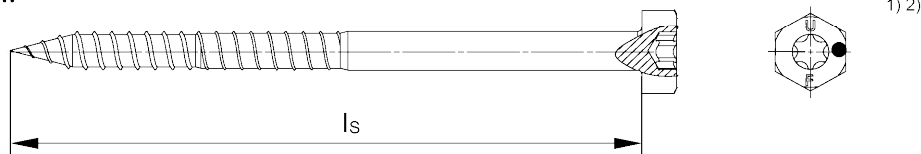

1) Additional marking for the special screw, stainless steel version: e.g. "A4" or "R" or "A2".

2) Internal driving feature for TX bit is optional for hexagonal head.

3) Optional additional version with underhead ribs.

Figures not to scale

fischer frame fixing DuoXpand

Product description

Anchor types, special screws
Marking and dimensions

Annex A 2

Appendix 4 / 25

Table A3.1: Dimensions

Anchor type	Anchor sleeve							Special screw		
	h_{nom} [mm]	d_{nom} [mm]	t_{fix} [mm]	min. l_d [mm]	max. l_d [mm]	$l_{sf}^{1)}$ [mm]	$d_{sf}^{1)}$ [mm]	d_s [mm]	l_G [mm]	l_s [mm]
DuoXpand 8	50	8	≥ 1	80	120	1,6	14,0	6,0	77	$l_d + d_s$
	70									
DuoXpand 10	50	10	≥ 1	80	230	2,2	18,5	7,0	77	$l_d + d_s$
	70									
	140 ²⁾									
	160 ²⁾									

¹⁾ Only valid for flat collar version.

²⁾ For base material Sepa Parpaing (see Annex C 13), additional h_{nom} available at $l_d \geq 160$ mm.

Table A3.2: Materials

Name	Material
Anchor sleeve	- Polyamide, PA6, colour grey - Polyoxymethylene, POM, colour red
Special screw	- Galvanised steel gvz with Zn5/Ag or Zn5/An in accordance with EN ISO 4042 <u>or</u> - Galvanised steel gvz with Zn5/Ag or Zn5/An in accordance with EN ISO 4042 with additional organic layer (Zn5/Ag/T7 or Zn5/An/T7, respectively) in three layers (total layer thickness $\geq 6 \mu\text{m}$) <u>or</u> - Stainless steel "A2" of corrosion resistance class CRC II in accordance with EN 1993-1-4 <u>or</u> - Stainless steel "A4" or "R" of corrosion resistance class CRC III in accordance with EN 1993-1-4

fischer frame fixing DuoXpand

Product description
Dimensions and materials

Annex A 3

Appendix 5 / 25

Specifications of intended use

Anchorage subject to:

- Static or quasi-static loads: DuoXpand 8 and DuoXpand 10.
- Redundant non-structural systems.
- Fire exposure for reinforced or unreinforced compacted normal weight concrete without fibres, strength classes $\geq C20/25$ as per EN 206 and solid brick masonry (for dry masonry only) with mean compressive strength $\geq 35 \text{ N/mm}^2$ as per EN 771, see Annex C 3 and Annex C 4: DuoXpand 10.

Base materials:

- Reinforced or unreinforced compacted normal weight concrete without fibres, strength classes $\geq C12/15$ (base material group "a"), as per EN 206, see Annex C 1 and C 5.
- Solid brick masonry (base material group "b") as per EN 771-1, EN 771-2 or EN 771-3, see Annex C 5, C 9, C 10. Note: The characteristic resistance is also valid for larger brick sizes and higher compressive strength of the masonry unit.
- Hollow brick masonry (base material group "c"), as per EN 771-1, EN 771-2 or EN 771-3, see Annex C 5 – C 8 and C 10 – C 14.
- Reinforced autoclaved aerated concrete (base material group "d"), as per EN 12602, and unreinforced autoclaved aerated concrete (base material group "d") as per EN 771-4, see Annex C 5 + C 15.
- Mortar strength class of the masonry $\geq M2,5$ in accordance with EN 998-2. In case of fire, all joints must be completely filled with mortar.
- For other comparable base materials of the base material group "a", "b", "c" and "d" the characteristic resistance of the anchor may be determined by job site tests in accordance with EOTA TR 051.

Temperature Range:

- c: - 40 °C to 50 °C (max. short term temperature + 50 °C and max long term temperature + 30 °C)
- b: - 40 °C to 80 °C (max. short term temperature + 80 °C and max long term temperature + 50 °C)

Use conditions (Environmental conditions):

- Structures subject to dry internal conditions: Special screw made of zinc coated steel or stainless steel.
- The specific screw made of galvanised steel or galvanised steel with an additional organic layer may also be used in structures subject to external atmospheric exposure, if the area of the head of the screw is protected against moisture and driving rain after mounting of the fixing unit in this way, that intrusion of moisture into the anchor shaft is prevented. Therefore, there shall be an external cladding or a ventilated rainscreen mounted in front of the head of the screw and the head of the screw itself shall be coated with a soft plastic, permanently elastic bitumen-oil-combination coating (e.g. undercoating or body cavity protection for cars).
- Structures subject to external atmospheric exposure (including industrial and marine environment) and to permanently damp internal condition, if no particular aggressive conditions exist: Special screw made of stainless steel of corrosion resistance class CRC III.

Note: Particular aggressive conditions are e.g. permanent, alternating immersion in seawater or the splash zone of seawater, chloride atmosphere of indoor swimming pools or atmosphere with extreme chemical pollution (e.g. in desulphurization plants or road tunnels where de-icing materials are used).

Design:

- The anchorages are to be designed in accordance with EOTA TR 064 under the responsibility of an engineer experienced in anchorages and concrete/masonry work.
- Verifiable calculation notes and drawings shall be prepared taking account of the loads to be anchored, the nature and strength of the base materials and the dimensions of the anchorage members as well as of the relevant tolerances. The position of the anchor is indicated on the design drawings.
- For requirements to resistance to fire local spalling of the concrete cover and cracks in masonry under fire exposure over 0,3 mm must be avoided.

Installation:

- Hole drilling by the drilling method in accordance with Annex C 1 for base material group "a", and in accordance with Annexes C 9 – C 15 for base material group "b", "c" and "d".
- Anchor installation carried out by appropriately qualified personnel and under the supervision of the person responsible for technical matters of the site.
- Installation temperature: - 20 °C to + 40 °C.
- Exposure to UV due to solar radiation of the anchor not protected by rendering ≤ 6 weeks.
- No ingress of water in the borehole at temperatures $< 0^\circ\text{C}$.

fischer frame fixing DuoXpand

Intended use
Specifications

Annex B 1

Appendix 6 / 25

Table B2.1: Installation parameters

Anchor type		DuoXpand 8	DuoXpand 10
Nominal drill hole diameter	$d_0 =$ [mm]	8	10
Cutting diameter of drill bit	$d_{cut} \leq$ [mm]	8,45	10,45
Overall plastic anchor embedment depth in the base material ¹⁾	$h_{nom1} \geq$ [mm]	50	50
	$h_{nom2} \geq$ [mm]	70	70
	$h_{nom3}^{2)} \geq$ [mm]	-	140
	$h_{nom4}^{2)} \geq$ [mm]	-	160
Depth of drill hole to deepest point	$h_{1,1} \geq$ [mm]	60	60
	$h_{1,2} \geq$ [mm]	80	80
	$h_{1,3}^{2)} \geq$ [mm]	-	150
	$h_{1,4}^{2)} \geq$ [mm]	-	170
Diameter of clearance hole in the fixture	$d_f \leq$ [mm]	8,5	10,5

¹⁾ For base material group "c": If the embedment depth is higher than h_{nom} given in the Table B2.1, job site tests have to be carried out in accordance with EOTA TR 051.

²⁾ Only valid for Sepa Parpaing see Annex C 13 at anchor length $l_d \geq 160$ mm.

Table B2.2: Minimum thickness of member, edge distances and spacing in concrete – base material group "a"⁽¹⁾

Anchor Type	Embedment depth h_{nom} [mm]	Concrete strength class	Minimum thickness of member h_{min} [mm]	Characteristic edge distance c_{cr} [mm]	Characteristic spacing s_{cr} [mm]	Minimum edge distances and spacing ²⁾ c_{min}, s_{min} [mm]
DuoXpand 8	≥ 50	C12/15	80	70	90	$s_{min} = 70$ for $c \geq 140$ $c_{min} = 70$ for $s \geq 140$
		\geq C16/20		50	65	$s_{min} = 50$ for $c \geq 100$ $c_{min} = 50$ for $s \geq 100$
	≥ 70	C12/15	100	70	100	$s_{min} = 70$ for $c \geq 140$ $c_{min} = 70$ for $s \geq 140$
		\geq C16/20		50	70	$s_{min} = 50$ for $c \geq 100$ $c_{min} = 50$ for $s \geq 100$
DuoXpand 10	≥ 50	C12/15	80	70	100	$s_{min} = 70$ for $c \geq 140$ $c_{min} = 70$ for $s \geq 140$
		\geq C16/20		50	70	$s_{min} = 50$ for $c \geq 100$ $c_{min} = 50$ for $s \geq 100$
	≥ 70	C12/15	100	70	115	$s_{min} = 70$ for $c \geq 140$ $c_{min} = 70$ for $s \geq 140$
		\geq C16/20		50	80	$s_{min} = 50$ for $c \geq 100$ $c_{min} = 50$ for $s \geq 100$

¹⁾ See scheme of edge distances and spacing Annex B 3.

²⁾ Intermediate values by linear interpolation.

Fixing points with spacing $a \leq s_{cr}$ are considered as a group with a maximum characteristic resistance $N_{RK,p}$ as per Table C1.2. For spacing $a > s_{cr}$ the anchors are considered as single anchors, each with a characteristic resistance $N_{RK,p}$ as per Table C1.2.

fischer frame fixing DuoXpand

Intended use

Installation parameters

Minimum thickness of member, edge distances and spacing for use in concrete

Annex B 2

Appendix 7 / 25

Table B3.1: Minimum thickness of member, edge distances and spacing in solid and hollow or perforated masonry – base material group “b” and “c”

Anchor Type		DuoXpand 8	DuoXpand 10
Minimum thickness of member ¹⁾	h_{min} [mm]	115	115
Spacing between anchor groups and / or single anchors	a_{min} [mm]	250	250
Single anchor			
Minimum edge distance	c_{min} [mm]	100	100
Anchor group			
Minimum spacing perpendicular to free edge	$s_{1,min}$ [mm]	100	100
Minimum spacing parallel to free edge	$s_{2,min}$ [mm]	100	100
Minimum edge distance	c_{min} [mm]	100	100

¹⁾ Member thickness according to Annex C 5 – C 8.

Scheme of edge distances and spacing

in concrete, solid and hollow or perforated masonry
base material group “a”, “b” and “c”

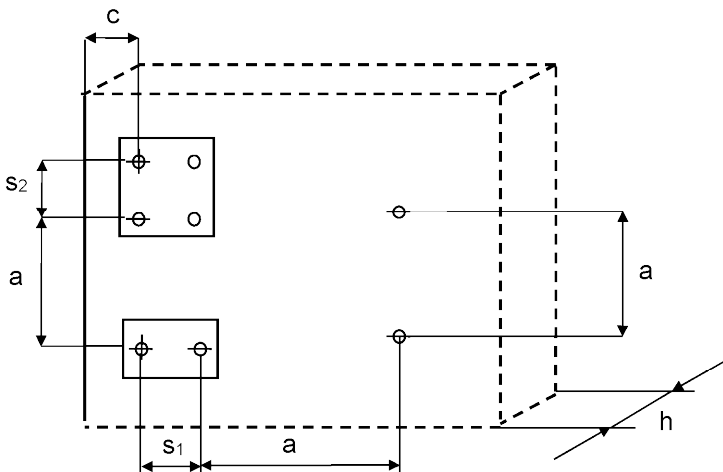

Figure not to scale

fischer frame fixing DuoXpand

Intended use

Minimum thickness of member, edge distances and spacing for use in solid, hollow or perforated masonry

Annex B 3

Appendix 8 / 25

Table B4.1: Minimum thickness of member, edge distances and spacing in reinforced and unreinforced autoclaved aerated concrete – base material group “d”

Anchor type		DuoXpand 8		DuoXpand 10	
Compressive strength ¹⁾	$f_{ck} / f_{cm,decl}$ [N/mm ²]	≥ 2	≥ 6	≥ 2	≥ 6
Nominal embedment depth	$h_{nom} \geq$ [mm]	70	70	70	70
Spacing between anchor groups and / or single anchors	a_{min} [mm]	250	250	250	250
Single anchor					
Minimum thickness of member	h_{min} [mm]	100	100	100	100
Minimum edge distance	c_{min} [mm]	100	100	100	100
Anchor group					
Minimum thickness of member	h_{min} [mm]	100	175	100	175
Minimum edge distance	c_{min} [mm]	100	100	100	100
Minimum spacing perpendicular to free edge	$s_{1,min}$ [mm]	100	100	100	100
Minimum spacing parallel to free edge	$s_{2,min}$ [mm]	100	80	100	80

¹⁾ See Table C15.1 and C15.2.

Scheme of edge distances and spacing

in reinforced and unreinforced autoclaved aerated concrete base material group “d”

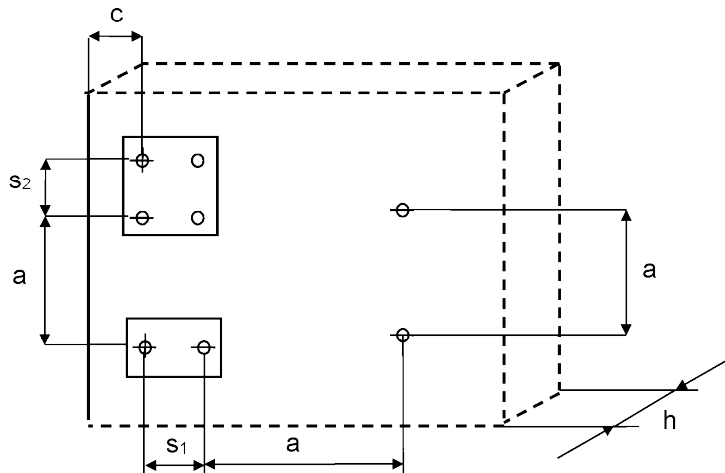

Figure not to scale

fischer frame fixing DuoXpand

Intended use

Minimum thickness of member, edge distances and spacing for use in reinforced and unreinforced autoclaved aerated concrete

Annex B 4

Appendix 9 / 25

Installation instructions

The following pictures show fixing through timber in concrete and hollow brick –
Summary of all kind of masonry bricks see Annex C 5 – C 8.

Solid bricks

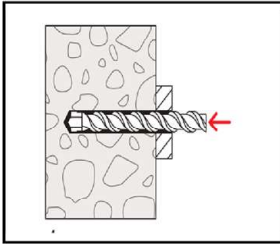

Hollow or perforated bricks

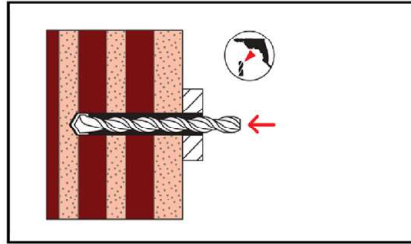

1. Drill the bore hole as per Table B2.1 using the drilling method described in the corresponding Annex C.

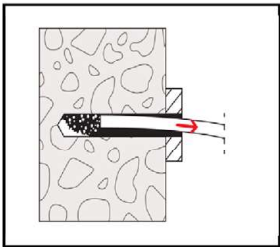

For application in hollow or perforated bricks, removal of bore dust is not necessary.

2. For use in base material group "a" (concrete), "b" (solid bricks), "d" (autoclaved aerated concrete): Remove dust from borehole.

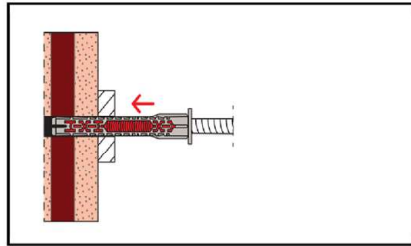
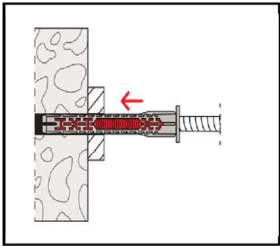

3. Insert anchor (screw and sleeve) by using a hammer until the collar of the plastic sleeve is flush with the surface of the fixture.

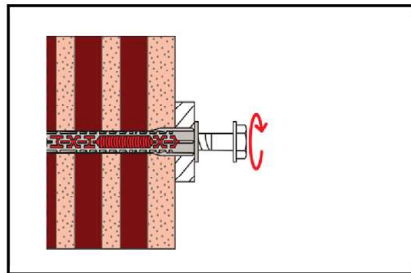
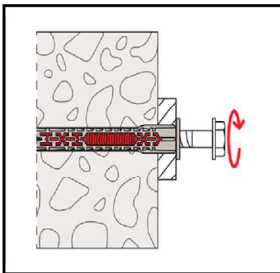

4. The screw is screwed-in until the head of the screw touches the sleeve. The anchor is correctly installed, if the head of the screw fits tight on the surface and nor the anchor sleeve neither the screw cannot be turned-in any further.

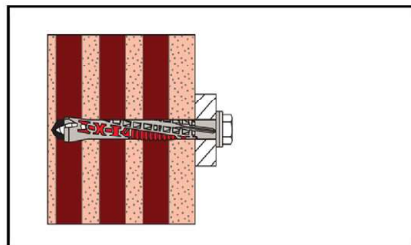
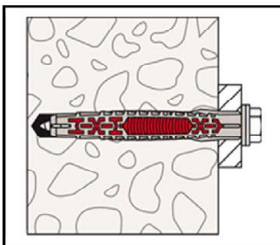

5. Correctly installed anchor.

fischer frame fixing DuoXpand

Intended use
Installation instructions

Annex B 5

Appendix 10 / 25

Table C1.1: Characteristic resistance of the screws

Failure of expansion element (special screw)	DuoXpand 8		DuoXpand 10	
	galvanised steel	stainless steel	galvanised steel	stainless steel
Characteristic tension resistance $N_{Rk,s}$ [kN]	14,8	14,3	21,7	21,7
Partial factor $\gamma_{Ms}^{1)}$ [-]	1,50	1,55	1,55	1,55
Characteristic shear resistance $V_{Rk,s}$ [kN]	7,4	7,1	10,8	10,8
Partial factor $\gamma_{Ms}^{1)}$ [-]	1,25	1,29	1,29	1,29
Characteristic bending resistance of the screw				
Characteristic bending resistance $M_{Rk,s}$ [Nm]	12,4	12,0	20,6	20,6
Partial factor $\gamma_{Ms}^{1)}$ [-]	1,25	1,29	1,29	1,29

¹⁾ In absence of other national regulations.

**Table C1.2: Characteristic resistance due to pullout-failure for use in concrete
– base material group “a”¹⁾**

Pull-out failure (plastic sleeve)		DuoXpand 8		DuoXpand 10	
Embedment depth h_{nom} [mm]	\geq	50	70	50	70
Concrete \geq C12/15					
Characteristic tension resistance (30/50 °C)	$N_{Rk,p}$ [kN]	3,5	4,0	3,5 / 4,0 ²⁾	5,0
Characteristic tension resistance (50/80 °C)	$N_{Rk,p}$ [kN]	3,5	4,0	3,0 / 4,0 ²⁾	4,5
Partial factor	$\gamma_{Mc}^{3)}$ [-]	1,8			

¹⁾ Drilling method: hammer drilling.

²⁾ Valid for concrete \geq C16/20.

³⁾ In absence of other national regulations.

fischer frame fixing DuoXpand

Performances

Characteristic resistance and characteristic bending resistance of the screw
Characteristic resistance for use in concrete

Annex C 1

Appendix 11 / 25

Table C2.1: Displacements¹⁾ under tension and shear loading in concrete, in solid bricks and in hollow or perforated bricks

Displacements under			Tension load ²⁾		Shear load ²⁾	
Anchor type	h_{nom} [mm]	F [kN]	δ_{NO} [mm]	$\delta_{N\infty}$ [mm]	δ_{VO} [mm]	$\delta_{V\infty}$ [mm]
DuoXpand 8	50	1,4	0,46	0,92	0,60	0,90
	70	1,6	0,45	0,90	0,63	0,95
DuoXpand 10	50	1,6	0,59	1,18	0,68	1,02
	70	2,0	0,58	1,16	0,88	1,32
	140 ³⁾	1,6	0,59	1,18	0,68	1,02
	160 ³⁾	2,0	0,58	1,16	0,88	1,32

¹⁾ Valid for all ranges of temperatures.

²⁾ Intermediate values by linear interpolation.

³⁾ Only valid for Sepa Parpaing see Annex C 13.

Table C2.2: Displacements¹⁾ under tension and shear loading in reinforced and unreinforced autoclaved aerated concrete

Displacements under				Tension load ²⁾		Shear load ²⁾	
Anchor type	$f_{ck} / f_{cm,decl}$ [N/mm ²]	h_{nom} [mm]	F [kN]	δ_{NO} [mm]	$\delta_{N\infty}$ [mm]	δ_{VO} [mm]	$\delta_{V\infty}$ [mm]
DuoXpand 8	≥ 2	70	0,11	0,13	0,26	0,22	0,33
	≥ 6	70	0,71	0,68	1,36	1,42	2,13
DuoXpand 10	≥ 2	70	0,18	0,12	0,24	0,36	0,54
	≥ 6	70	0,32	0,66	1,32	0,64	0,96

¹⁾ Valid for all ranges of temperatures.

²⁾ Intermediate values by linear interpolation.

fischer frame fixing DuoXpand

Performances

Displacements under tension and shear loading in concrete, masonry and autoclaved aerated concrete

Annex C 2

Appendix 12 / 25

Figure C3.1: Characteristic fire resistance under inclined loading, load direction α , in concrete – base material group “a” and solid brick masonry – base material group “b”

The characteristic fire resistance for each fire resistance class shall be interpolated for load direction α between 45° and 90° according to following equation:

$$F_{Rk,fi}(\alpha) = \frac{0,71 \cdot F_{Rk,fi}(45^\circ)}{\cos \alpha} \leq F_{Rk,fi}(90^\circ)$$

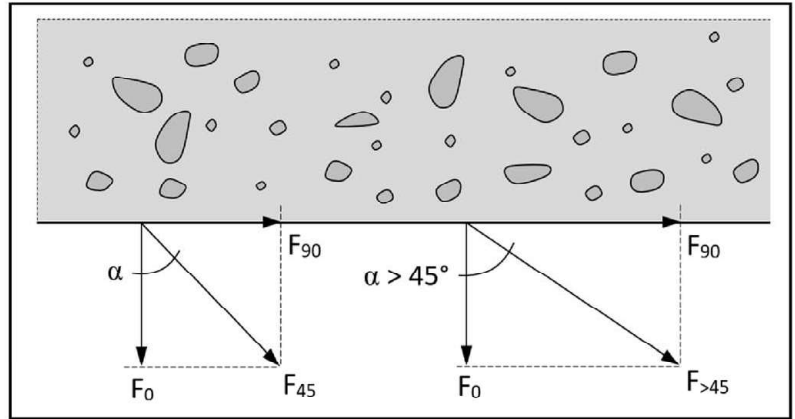

Table C3.1: Characteristic fire resistance in concrete \geq C20/25 – base material group “a”

			DuoXpand 10			
			R30	R60	R90	R120
Embedment depth	$h_{nom} \geq$ [mm]		70			
Characteristic fire resistance under inclined loading for selected load directions α						
$\alpha = 45^\circ$	$F_{Rk,fi}(45^\circ)$ [kN]		0,51	0,34	0,17	.. ²⁾
$\alpha = 60^\circ$	$F_{Rk,fi}(60^\circ)$ [kN]		0,72	0,48	0,24	.. ²⁾
$\alpha = 75^\circ$	$F_{Rk,fi}(75^\circ)$ [kN]		1,39	0,93	0,46	.. ²⁾
Partial factor	$\gamma_{M,fi}$ ¹⁾ [-]		1,0			
Characteristic fire resistance for shear load without lever arm						
Characteristic shear resistance	$F_{Rk,fi}(90^\circ)$ [kN]		2,30	1,80	1,30	1,05
Partial factor	$\gamma_{M,fi}$ ¹⁾ [-]		1,0			
Characteristic fire resistance for shear load with lever arm						
Characteristic bending resistance	$M_{Rk,s,fi}$ ³⁾ [Nm]		2,41	1,89	1,37	1,10
Partial factor	$\gamma_{M,fi}$ ¹⁾ [-]		1,0			
Minimum edge distances under fire exposure	$c_{min,fi}$ [mm]		$2 \times h_{nom}$			
Minimum spacing under fire exposure	$s_{min,fi}$ [mm]		$4 \times h_{nom}$			

¹⁾ In absence of other national regulations.

²⁾ No performance assessed.

³⁾ Shear load with lever arm is to be limited to a maximum acting load $F_{Rk,fi}(45^\circ)$.

**Table C3.2: Values under fire exposure in concrete C20/25 to C50/60 in any load direction (no permanent centric tension load, only for shear load without lever arm)
Fastening of façade systems**

Anchor type	Fire resistance class	Load direction α	$F_{Rk,fi,90}$	$\gamma_{M,fi}$ ¹⁾
DuoXpand 10	R90	$\geq 81^\circ$	0,8 kN	1,0

¹⁾ In absence of other national regulations.

fischer frame fixing DuoXpand

Performances

Characteristic fire resistance for use in concrete

Table C4.1: Characteristic fire resistance in solid brick masonry– base material group “b”						
Base material; bulk density [kg/dm³]; mean compressive strength [N/mm²] [Supplier Title, country] Geometry, DF or nominal size (L x W x H) [mm] drilling method			Anchor type			
Clay brick Mz; $\rho \geq 1,8$; 35 as per EN 771-1 e.g. Mz Ziegelwerk Nordhausen, DE; NF (240x115x71) Hammer drilling			DuoXpand 10			
Calcium silicate solid brick KS; $\rho \geq 2,0$; 35 as per EN 771-2 e.g. KS Wemding, DE; NF (240x115x71) Hammer drilling						
			R30	R60	R90	R120
Embedment depth	h_{nom}	\geq [mm]	70			
Characteristic fire resistance under inclined loading for selected load directions α						
$\alpha = 45^\circ$	$F_{Rk,fi}(45^\circ)$	[kN]	0,51	0,34	0,17	-²⁾
$\alpha = 60^\circ$	$F_{Rk,fi}(60^\circ)$	[kN]	0,72	0,48	0,24	-²⁾
$\alpha = 75^\circ$	$F_{Rk,fi}(75^\circ)$	[kN]	1,30	0,93	0,46	-²⁾
Partial factor	$\gamma_{M,fi}$¹⁾	[-]	1,0			
Characteristic fire resistance for shear load without lever arm						
Characteristic shear resistance	$F_{Rk,fi}(90^\circ)$	[kN]	1,30			1,05
Partial factor	$\gamma_{M,fi}$¹⁾	[-]	1,0			
Characteristic fire resistance for shear load with lever arm						
Characteristic bending resistance	$M_{Rk,s,fi}$	[Nm]	2,41	1,89	1,37	1,10
Partial factor	$\gamma_{M,fi}$¹⁾	[-]	1,0			
Minimum edge distances under fire exposure	$c_{min,fi}$	[mm]	$2 \times h_{nom}$			
Minimum spacing under fire exposure	$s_{min,fi}$	[mm]	$4 \times h_{nom}$			
¹⁾ In absence of other national regulations. ²⁾ No performance assessed.						
fischer frame fixing DuoXpand						Annex C 4 Appendix 14 / 25
Performances Characteristic fire resistance for use in solid brick masonry						

Table C5.1: Summary of base materials concrete group “a”, solid bricks group “b”¹⁾ and autoclaved aerated concrete group “d”

Base material	Format	Dimensions (L x W x H) [mm]	Mean compressive strength as per EN 771 [N/mm ²]	Bulk density ρ [kg/dm ³]	See Annex
Concrete ≥ C12/15 as per EN 206					C 1
Autoclaved aerated concrete as per EN 771-4					C 15
Reinforced autoclaved aerated concrete, AAC as per EN 12602					C 15
Clay brick Mz , as per EN 771-1, <i>e.g. Mz Ziegelwerk Nordhausen, DE</i>	NF	240x115x71	≥ 10	≥ 1,8	C 9
Calcium silicate solid brick KS , as per EN 771-2, <i>e.g. KS Wemding, DE</i>	NF	240x115x71	≥ 10	≥ 2,0	C 9
Calcium silicate solid brick KS , as per EN 771-2, <i>e.g. KS Wemding, DE</i>	12 DF	498x175x248	≥ 10	≥ 1,8	C 9
Lightweight solid brick Vbl , as per EN 771-3, <i>e.g. Vbl KLB, DE</i>	2 DF	240x115x113	≥ 2,5	≥ 1,4	C 10

¹⁾ Vertically perforation ≤ 15%; cross section reduced by perforation vertically to the resting area.

Table C5.2: Summary of hollow or perforated bricks – base material group “c”⁽¹⁾

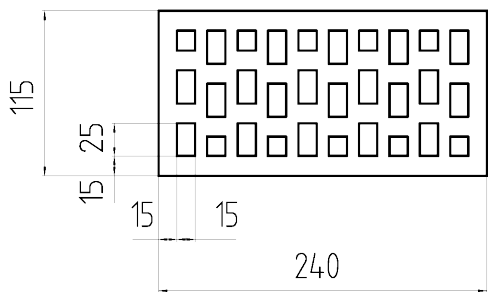
Base material	Format/ Dimensions (L x W x H) [mm]	Brick drawing [mm]	Mean compressive strength as per EN 771 [N/mm ²] / bulk density ρ [kg/dm ³]	See Annex
Perforated clay brick Hlz , as per EN 771-1, <i>e.g. Wienerberger Hlz, DE</i>	2 DF 240 x 115 x 113		≥ 5,0 / ρ ≥ 0,9	C 10

¹⁾ Vertically perforation > 15 % and ≤ 50 %, cross section reduced by perforation vertically to the resting area.

Figure not to scale

fischer frame fixing DuoXpand	Annex C 5 Appendix 15 / 25
Performances Summary of base materials concrete, solid bricks, autoclaved aerated concrete and hollow or perforated bricks	

Table C6.1: Summary of hollow or perforated bricks – base material group “c”⁽¹⁾

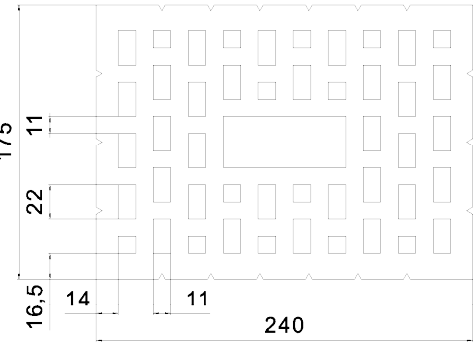
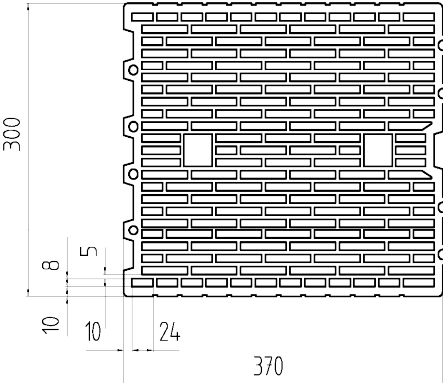
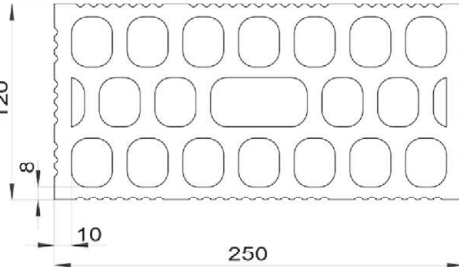
Base material	Format/ Dimensions (L x W x H) [mm]	Brick drawing [mm]	Mean compressive strength as per EN 771 [N/mm ²] / bulk density ρ [kg/dm ³]	See Annex
<p>Perforated clay brick HLz, as per EN 771-1, e.g. <i>Schlagmann, DE</i></p>	<p>3 DF 240x175x113</p>		<p>≥ 5,0 / ρ ≥ 0,9</p>	<p>C 10</p>
<p>Perforated clay brick HLz, as per EN 771-1, e.g. <i>Wienerberger Porotherm 30 R, FR</i></p>	<p>370x300x250</p>		<p>≥ 7,5 / ρ ≥ 0,7</p>	<p>C 11</p>
<p>Perforated clay brick HLz, as per EN 771-1, e.g. <i>Doppio Uni IT Wienerberger, IT</i></p>	<p>250x120x190</p>		<p>≥ 5,0 / ρ ≥ 0,9</p>	<p>C 11</p>

¹⁾ Vertically perforation > 15 % and ≤ 50 %, cross section reduced by perforation vertically to the resting area.

Figures not to scale

fischer frame fixing DuoXpand

Performances
Summary of base materials hollow or perforated bricks

Annex C 6

Appendix 16 / 25

Table C7.1: Summary of hollow or perforated bricks – base material group “c”⁽¹⁾

Base material	Format/ Dimensions (L x W x H) [mm]	Brick drawing [mm]	Mean compressive strength as per EN 771 [N/mm ²] / bulk density ρ [kg/dm ³]	See Annex
<p>Perforated clay brick HLz, as per EN 771-1, <i>e.g. Wienerberger Pth Bio Modulare, DE</i></p>	<p>8 DF 300x250x190</p>		<p>≥ 7,5 / ρ ≥ 1,0</p>	<p>C 11</p>
<p>Calcium silicate hollow brick KSL, as per EN 771-2, <i>e.g. Bösel, DE</i></p>	<p>2 DF 240x115x113</p>		<p>≥ 10 / ρ ≥ 1,6</p>	<p>C 12</p>
<p>Calcium silicate hollow brick KSL, as per EN 771-2, <i>e.g. KS Wemding, DE</i></p>	<p>3 DF 240x175x113</p>		<p>≥ 10 / ρ ≥ 1,4</p>	<p>C 12</p>

¹⁾ Vertically perforation > 15 % and ≤ 50 %, cross section reduced by perforation vertically to the resting area.

Figures not to scale

fischer frame fixing DuoXpand

Performances

Summary of base materials hollow or perforated bricks

Annex C 7

Appendix 17 / 25

Table C8.1: Summary of hollow or perforated bricks – base material group “c”⁽¹⁾

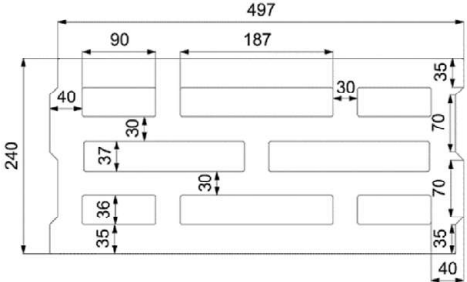
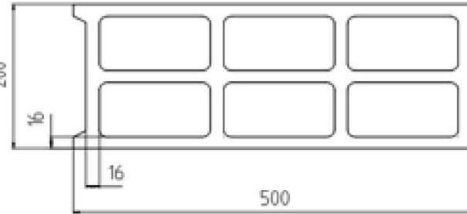
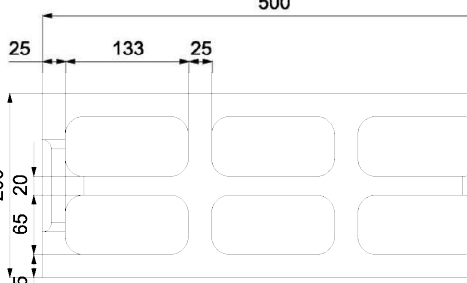
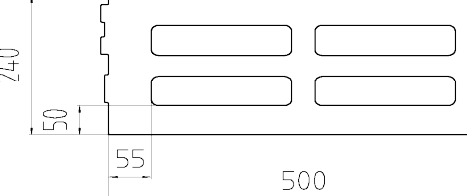
Base material	Format/ Dimensions (L x W x H) [mm]	Brick drawing [mm]	Mean compressive strength as per EN 771 [N/mm ²] / bulk density ρ [kg/dm ³]	See Annex
Hollow brick lightweight concrete Hbl, as per EN 771-3, e.g. <i>Knobel, DE</i>	16DF 495x240x248		$\geq 2,5 /$ $\rho \geq 0,7$	C 12
Hollow brick lightweight concrete Hbl, as per EN 771-3, e.g. <i>Sepa Parpaing, FR</i>	500x200x200		$\geq 2,5 /$ $\rho \geq 1,0$	C 13
Hollow brick lightweight concrete Hbl, as per EN 771-3, e.g. <i>Indelasa, ES</i>	500x200x200		$\geq 2,5 /$ $\rho \geq 1,0$	C 14
Hollow brick lightweight concrete Hbl, as per EN 771-3, e.g. <i>Knobel, DE</i>	500x240x240		$\geq 2,5 /$ $\rho \geq 0,9$	C 14

¹⁾ Vertically perforation > 15 % and ≤ 50 %, cross section reduced by perforation vertically to the resting area.

Figures not to scale

fischer frame fixing DuoXpand

Performances
Summary of base materials hollow or perforated bricks

Annex C 8

Appendix 18 / 25

Table C9.1: Characteristic resistance F_{Rk} in [kN] for use in solid masonry - base material group "b"

Base material; bulk density [kg/dm ³] [Supplier Title, country] Geometry, DF or nominal size (L x W x H) [mm] and drilling method	Mean compressive strength as per EN 771/ Minimum compressive strength single brick ⁹⁾ [N/mm ²]	Characteristic resistance F_{Rk} [kN] Temperature range 30/50 °C and 50/80 °C			
		DuoXpand 8		DuoXpand 10	
		h_{nom} [mm]			
		≥ 50	≥ 70	≥ 50	≥ 70
Clay brick Mz; $\rho \geq 1,8$ as per EN 771-1 <i>e.g. Mz Ziegelwerk Nordhausen, DE</i> NF (240x115x71) Hammer drilling	12,5/10,0	1,5	1,5	0,9 / 1,5 ⁷⁾	0,9 / 2,0 ⁷⁾
	15,0/12,0	2,0	2,0	1,2 / 2,0 ⁷⁾	1,2 / 2,0 ⁷⁾
	20,0/16,0	2,5	2,5	1,5 / 2,5 ⁷⁾	1,5 / 3,0 ⁷⁾
	25,0/20,0	3,0	3,5	2,0 / 3,0 ⁷⁾	2,0 / 3,5 ⁷⁾
	35,0/28,0	4,5	5,0	3,0 / 4,5 ⁷⁾	3,0 / 5,0 ⁷⁾
	37,3/-	4,5	5,0	3,0 / 4,5 ⁷⁾	3,0 / 5,5 ⁷⁾
Clay brick Mz; $\rho \geq 1,8$ as per EN 771-1 <i>e.g. Mz Ziegelwerk Nordhausen, DE</i> NF (240x115x71) Rotary drilling	10,0/8,0	1,5	2,0	1,5	2,0 / 2,5 ²⁾
	12,5/10,0	2,0	2,5	2,0	2,5 / 3,0 ²⁾ / 3,5 ⁵⁾
	15,0/12,0	2,5	3,0	2,5	3,0 / 4,0 ²⁾
	18,5/-	3,0	3,5	3,0	4,0 / 4,5 ²⁾ / 5,0 ³⁾
Calcium silicate solid brick KS; $\rho \geq 2,0$ as per EN 771-2 <i>e.g. KS Wemding, DE</i> NF (240x115x71) Hammer drilling	10,0/8,0	1,2 / 1,5 ¹⁾	1,5	1,5	1,5 / 2,0 ⁶⁾
	12,5/10,0	1,5	2,0	2,0	2,0 / 2,5 ²⁾
	15,0/12,0	2,0	2,5	2,5	2,5 / 3,0 ²⁾
	20,0/16,0	2,5	3,0 / 3,5 ⁴⁾	3,0 / 3,5 ²⁾	3,5 / 4,0 ²⁾
	25,0/20,0	3,5	4,0	4,0 / 4,5 ⁴⁾	4,0 / 4,5 ⁶⁾ / 5,0 ²⁾
	30,0/-	4,0	4,5 / 5,0 ²⁾	4,5 / 5,0 ²⁾	5,0 / 5,5 ⁶⁾ / 6,0 ²⁾
Calcium silicate solid brick KS; $\rho \geq 1,8$ as per EN 771-2 <i>e.g. KS Wemding, DE</i> 12 DF (498x175x248) Hammer drilling	10,0/8,0	1,5	2,0	2,0	2,0 / 2,5 ⁶⁾
	12,5/10,0	2,0	2,5	2,5	2,5 / 3,0 ⁶⁾
	15,0/12,0	2,5	3,0	3,0	3,0 / 3,5 ⁶⁾ / 4,0 ²⁾
	20,0/16,0	3,5	3,5	3,5	4,0 / 4,5 ⁶⁾ / 5,0 ²⁾
	25,0/20,0	4,5	4,5	4,5	5,0 / 6,0 ⁶⁾ / 6,5 ²⁾
	26,5/-	4,5	5,0	5,0	5,5 / 6,0 ⁶⁾ / 6,5 ²⁾
Partial factor	γ_{Mm} ⁸⁾ [-]	2,5			

1) Only valid for temperature range "c" (30/50 °C).

2) Only valid for c_{1min} 120 mm and c_{2min} 180 mm.

3) Only valid for c_{1min} 130 mm and c_{2min} 195 mm.

4) Only valid for c_{1min} 120 mm and c_{2min} 180 mm for temperature range "c" (30/50 °C).

5) Only valid for c_{1min} 130 mm and c_{2min} 195 mm for temperature range "c" (30/50 °C).

6) Only valid for c_{1min} 110 mm and c_{2min} 165 mm.

7) Only valid for $s_{2,min}$ 250 mm.

8) In absence of other national regulations.

9) The compressive strength of the single brick must not be less than 80% of the mean compressive strength.

fischer frame fixing DuoXpand

Performances

Characteristic resistance for use in solid masonry

Annex C 9

Appendix 19 / 25

Table C10.1: Characteristic resistance F_{Rk} in [kN] for use in solid and in hollow or perforated masonry - base material group "b" and "c"

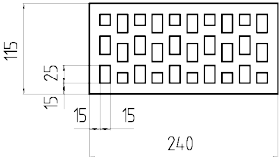
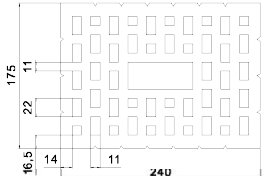
Base material; bulk density [kg/dm ³] [Supplier Title, country] Geometry, DF or nominal size (L x W x H) [mm] and drilling method	Mean compressive strength as per EN 771/ Minimum compressive strength single brick ⁴⁾ [N/mm ²]	Characteristic resistance F_{Rk} [kN] Temperature range 30/50 °C and 50/80 °C			
		DuoXpand 8		DuoXpand 10	
		h_{nom} [mm] ¹⁾			
		50	70	50	70
Lightweight solid brick Vbl; $\rho \geq 1,4$ as per EN 771-3 e.g. Vbl KLB, DE 2 DF (240x115x113) Rotary drilling	2,5/2,0	0,4	0,6	0,3	0,6 / 0,75 ²⁾
	5,0/4,0	0,75 / 0,9 ²⁾	1,2	0,6 / 0,75 ²⁾	1,2 / 1,5 ²⁾
Perforated clay brick Hz; $\rho \geq 0,9$ as per EN 771-1 e.g. Wienerberger Hz, DE 	5,0/4,0	0,5	0,4	0,4	0,4
	7,5/6,0	0,75	0,6	0,6	0,6
	10,0/8,0	0,9	0,75	0,9	0,75
	10,9/-	0,9	0,75	0,9	0,9
	2 DF (240x115x113) Rotary drilling				
Perforated clay brick Hz; $\rho \geq 0,9$ as per EN 771-1 e.g. Schlagmann, DE 	5,0/4,0	0,3	0,5 / 0,6 ²⁾	0,3	0,5 / 0,6 ²⁾
	7,5/6,0	0,4	0,75 / 0,9 ²⁾	0,4 / 0,5 ²⁾	0,75 / 0,9 ²⁾
	10,0/8,0	0,6	0,9 / 1,2 ²⁾	0,6	1,2
	12,5/12,0	0,75	1,2 / 1,5 ²⁾	0,75	1,2 / 1,5 ²⁾
	15,0/10,0	0,9	1,5	0,9	1,5 / 2,0 ²⁾
	3 DF (240x175x113) Rotary drilling	16,2/-	0,9	1,5 / 2,0 ²⁾	0,9
Partial factor	γ_{Mm} ³⁾ [-]	2,5			

- 1) The lowest resistance of two consecutive embedment depths may be used for the intermediate embedment depths. Exception for "Lightweight solid brick Vbl": here $\geq h_{nom}$ is valid.
- 2) Only valid for temperature range "c" (30/50 °C).
- 3) In absence of other national regulations.
- 4) The compressive strength of the single brick must not be less than 80% of the mean compressive strength.

fischer frame fixing DuoXpand

Performances

Characteristic resistance for use in solid masonry, hollow or perforated masonry

Annex C 10

Appendix 20 / 25

Table C11.1: Characteristic resistance F_{Rk} in [kN] for use in hollow or perforated masonry - base material group "c"

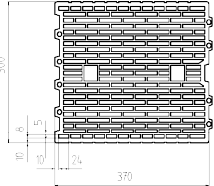
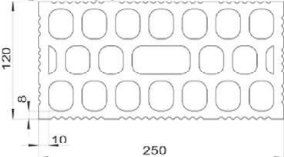
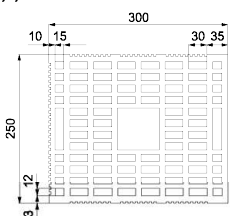
Base material; bulk density [kg/dm ³] [Supplier Title, country] Geometry, DF or nominal size (L x W x H) [mm] and drilling method	Mean compressive strength as per EN 771/ Minimum compressive strength single brick ⁴⁾ [N/mm ²]	Characteristic resistance F_{Rk} [kN] Temperature range 30/50 °C and 50/80 °C			
		DuoXpand 8		DuoXpand 10	
		h_{nom} [mm] ¹⁾			
		50	70	50	70
Perforated clay brick HLz; $\rho \geq 0,7$ as per EN 771-1 e.g. <i>Wienerberger Porotherm 30 R, FR</i>  370x300x250 Rotary drilling	7,5/6,0	0,3	0,3	0,3	0,3
	10,0/8,0	0,4	0,4	0,4	0,4
	12,5/10,0	0,5	0,5	0,5	0,5 / 0,6 ²⁾
	15,0/12,0	0,6	0,6	0,6	0,6
	17,6/-	0,75	0,75	0,75	0,75
Perforated clay brick HLz; $\rho \geq 0,9$ as per EN 771-1 e.g. <i>Doppio Uni IT Wienerberger, IT</i>  250x120x190 Rotary drilling	5,0/4,0	0,4	0,4	0,5	0,5
	7,5/6,0	0,6	0,5	0,75	0,75
	10,0/8,0	0,75	0,75	0,9	0,9
	12,5/10,0	0,9	0,9	1,2	1,2
	15,0/12,0	1,2	1,2	1,5	1,5
	18,7/-	1,5	1,2	2,0	2,0
Perforated clay brick HLz; $\rho \geq 1,0$ as per EN 771-1 e.g. <i>Wienerberger Pth Bio Modulare, IT</i>  8 DF (300x250x190) Rotary drilling	7,5/6,0	0,75	0,75	0,75	0,75
	10,0/8,0	0,9	0,9	0,9	0,9
	12,5/10,0	1,2	1,2	1,2	1,2
	15,0/12,0	1,5	1,5	1,5	1,5
	20,0/16,0	2,0	2,0	2,0	2,0
	23,6/-	2,5	2,5	2,5	2,5
Partial factor	$\gamma_{Mm}^{3)}$ [-]	2,5			

1) The lowest resistance of two consecutive embedment depths may be used for the intermediate embedment depths.

2) Only valid for temperature range "c" (30/50 °C). 3) In absence of other national regulations.

4) The compressive strength of the single brick must not be less than 80% of the mean compressive strength.

fischer frame fixing DuoXpand

Performances

Characteristic resistance for use in hollow or perforated masonry

Annex C 11

Appendix 21 / 25

Table C12.1: Characteristic resistance F_{Rk} in [kN] for use in hollow or perforated masonry - base material group „c“

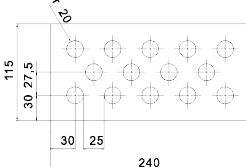
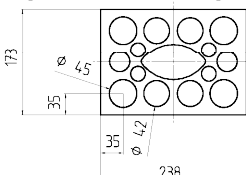
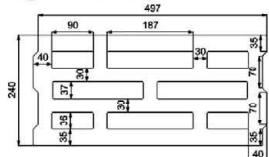
Base material; bulk density [kg/dm ³] [Supplier Title, country] Geometry, DF or nominal size (L x W x H) [mm] and drilling method	Mean compressive strength as per EN 771/ Minimum compressive strength single brick ⁴⁾ [N/mm ²]	Characteristic resistance F_{Rk} [kN] Temperature range 30/50 °C and 50/80 °C			
		DuoXpand 8		DuoXpand 10	
		h_{nom} [mm] ¹⁾			
		50	70	50	70
Calcium silicate hollow brick KSL; $\rho \geq 1,6$ as per EN 771-2 e.g. Bösel, DE  2 DF ($\geq 240 \times 115 \times 113$) Hammer drilling	10,0/8,0	0,75 / 0,9²⁾	0,9	0,9 / 1,2²⁾	1,2
	12,5/10,0	0,9 / 1,2²⁾	1,2	1,2 / 1,5²⁾	1,5
	15,0/12,0	1,2 / 1,5²⁾	1,5	1,5	2,0
	20,0/16,0	1,5 / 2,0²⁾	2,0	2,0 / 2,5²⁾	2,5
	25,0/20,0	2,0	2,5	2,5 / 3,0²⁾	3,0
	25,7/-	2,0 / 2,5²⁾	2,5	2,5 / 3,0²⁾	3,5
Calcium silicate hollow brick KSL; $\rho \geq 1,4$ as per EN 771-2 e.g. KS Wending, DE  3 DF (240x175x113) Hammer drilling	10,0/8,0	0,9	0,75 / 0,9²⁾	0,6 / 0,75²⁾	0,9 / 1,2²⁾
	12,5/10,0	1,2	0,9 / 1,2²⁾	0,75 / 0,9²⁾	1,2 / 1,5²⁾
	15,0/12,0	1,2 / 1,5²⁾	1,2 / 1,5²⁾	0,9 / 1,2²⁾	1,5
	20,0/16,0	1,5 / 2,0²⁾	1,5 / 2,0²⁾	1,2 / 1,5²⁾	2,0
	21,4/-	1,5 / 2,0²⁾	1,5 / 2,0²⁾	1,2 / 1,5²⁾	2,0 / 2,5²⁾
Hollow brick lightweight concrete Hbl; $\rho \geq 0,7$ as per EN 771-3 e.g. Knobel, DE  16 DF (495x240x248) Rotary drilling	2,5/2,0	0,5 / 0,6²⁾	0,5 / 0,6²⁾	0,75	0,75
	5,0/4,0	0,9 / 1,2²⁾	0,9 / 1,2²⁾	1,5	1,5
Partial factor	$\gamma_{Mm}^{3)}$ [-]	2,5			

1) The lowest resistance of two consecutive embedment depths may be used for the intermediate embedment depths.

2) Only valid for temperature range "c" (30/50 °C). 3) In absence of other national regulations.

4) The compressive strength of the single brick must not be less than 80% of the mean compressive strength.

fischer frame fixing DuoXpand

Performances

Characteristic resistance for use in hollow or perforated masonry

Annex C 12

Appendix 22 / 25

Table C13.1: Characteristic resistance F_{Rk} in [kN] for use in hollow or perforated masonry - base material group „c“

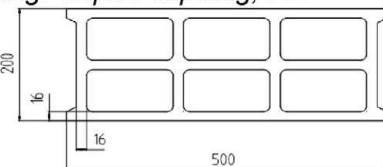
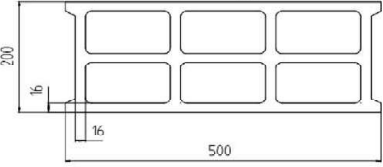
Base material; bulk density [kg/dm³] [Supplier Title, country] Geometry, DF or nominal size (L x W x H) [mm] and drilling method	Mean compressive strength as per EN 771/ Minimum compressive strength single brick ⁵⁾ [N/mm ²]	Characteristic resistance F_{Rk} [kN] Temperature range 30/50 °C and 50/80 °C					
		DuoXpand 8		DuoXpand 10			
		h_{nom} [mm] ¹⁾					
		50	70	50	70	140	160
Hollow brick lightweight concrete Hbl; $\rho \geq 1,0$ as per EN 771-3 e.g. <i>Sepa Parpaing, FR</i> 	2,5/2,0	0,3 / 0,4²⁾	³⁾	0,5	0,5	³⁾	0,3
	5,0/4,0	0,75	0,5	0,9	0,9	0,5	0,5
	6,9/-	0,9 / 1,2²⁾	0,6	1,5	1,5	0,6	0,75
500x200x200 Rotary drilling							
Hollow brick lightweight concrete Hbl; $\rho \geq 1,0$ as per EN 771-3 e.g. <i>Sepa Parpaing, FR</i> 	2,5/2,0	³⁾	³⁾	³⁾	0,3	³⁾	³⁾
	5,0/4,0	0,3	³⁾	0,3 / 0,4²⁾	0,6	³⁾	0,3 / 0,4²⁾
	6,9/-	0,4 / 0,5²⁾	³⁾	0,4 / 0,5²⁾	0,75 / 0,9²⁾	³⁾	0,4 / 0,6²⁾
500x200x200 Hammer drilling							
Partial factor	γ_{Mm}⁴⁾ [-]	2,5					

- 1) The lowest resistance of two consecutive embedment depths may be used for the intermediate embedment depths.
- 2) Only valid for temperature range "c" (30/50 °C).
- 3) No performance assessed.
- 4) In absence of other national regulations.
- 5) The compressive strength of the single brick must not be less than 80% of the mean compressive strength.

fischer frame fixing DuoXpand

Performances

Characteristic resistance for use in hollow or perforated masonry

Annex C 13

Appendix 23 / 25

Table C14.1: Characteristic resistance F_{Rk} in [kN] for use in hollow or perforated masonry - base material group „c“

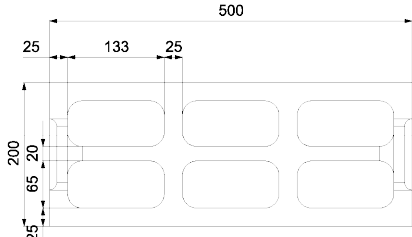
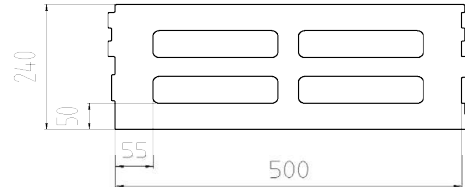
Base material; bulk density [kg/dm ³] [Supplier Title, country] Geometry, DF or nominal size (L x W x H) [mm] and drilling method	Mean compressive strength as per EN 771/ Minimum compressive strength single brick ⁴⁾ [N/mm ²]	Characteristic resistance F_{Rk} [kN] Temperature range 30/50 °C and 50/80 °C			
		DuoXpand 8		DuoXpand 10	
		h_{nom} [mm] ¹⁾			
		50	70	50	70
Hollow brick lightweight concrete Hbl; $\rho \geq 1,0$ as per EN 771-3 e.g. <i>Indelasa, ES</i> 	2,5/2,0	0,6	0,5	0,4	0,6
	4,8/-	1,2	0,9	0,75	0,9 / 1,2²⁾
Hollow brick lightweight concrete Hbl; $\rho \geq 0,9$ as per EN 771-3 e.g. <i>Knobel, DE</i> 	2,5/2,0	0,9	0,75 / 0,9²⁾	0,9	0,6
	5,0/4,0	1,5 / 2,0²⁾	1,5 / 2,0²⁾	2,0	1,5
	6,2/-	2,0 / 2,5²⁾	2,0 / 2,5²⁾	2,5	1,5
Partial factor	γ_{Mm} ³⁾ [-]	2,5			

- 1) The lowest resistance of two consecutive embedment depths may be used for the intermediate embedment depths.
- 2) Only valid for temperature range "c" (30/50 °C).
- 3) In absence of other national regulations.
- 4) The compressive strength of the single brick must not be less than 80% of the mean compressive strength.

fischer frame fixing DuoXpand

Performances

Characteristic resistance for use in hollow or perforated masonry

Annex C 14

Appendix 24 / 25

Table C15.1: Characteristic resistance F_{Rk} in [kN] for use in unreinforced autoclaved aerated concrete - base material group „d“

Base material Size (L x W x H) [mm] and drilling method	Mean compressive strength as per EN 771-4 $f_{cm,decl}$ [N/mm ²]	Characteristic resistance F_{Rk} [kN] Temperature range 30/50 °C and 50/80 °C	
		DuoXpand 8	DuoXpand 10
		h_{nom} [mm]	
		≥ 70	
Autoclaved aerated concrete as per EN 771-4 e.g. (500x120x300) e.g. (500x250x300) Hammer drilling	2,8	0,3	0,4 / 0,5 ¹⁾
	4,0	0,75	0,6
	5,0	0,9 / 1,2 ¹⁾	0,75
	6,9	1,5 / 2,0 ¹⁾	0,9
Partial factor	$\gamma_{MAAC}^{2)}$ [-]	2,0	

¹⁾ Only valid for temperature range "c" (30/50 °C).

²⁾ In absence of other national regulations.

Table C15.2: Characteristic resistance F_{Rk} in [kN] for use in reinforced autoclaved aerated concrete - base material group „d“

Base material minimum member thickness h_{min} and drilling method	Compressive strength f_{ck} [N/mm ²] (compressive strength class) as per EN 12602	Characteristic resistance F_{Rk} [kN] Temperature range 30/50 °C and 50/80 °C	
		DuoXpand 8	DuoXpand 10
		h_{nom} [mm]	
		≥ 70	
Reinforced autoclaved aerated concrete AAC as per EN 12602 $h_{min} = 100$ mm ³⁾ Hammer drilling	≥ 2,0 (AAC 2)	2)	0,3 ¹⁾
	≥ 2,5 (AAC 2,5)	2)	0,3 / 0,4 ¹⁾
	≥ 3,0 (AAC 3)	2)	0,4
	≥ 3,5 (AAC 3,5)	2)	0,4 / 0,5 ¹⁾
	≥ 4,0 (AAC 4)	2)	0,5 / 0,6 ¹⁾
	≥ 4,5 (AAC 4,5)	2)	0,6 / 0,75 ¹⁾
	≥ 5,0 (AAC 5)	2)	0,75
	≥ 6,0 (AAC 6)	2)	0,9
Partial factor	$\gamma_{MAAC}^{4)}$ [-]	2,0	

¹⁾ Only valid for temperature range "c" (30/50 °C).

²⁾ No performance assessed.

³⁾ For anchor groups in AAC 6 $h_{min} = 175$ mm.

⁴⁾ In absence of other national regulations.

fischer frame fixing DuoXpand

Performances

Characteristic resistance for use in autoclaved aerated concrete and in reinforced autoclaved aerated concrete

Annex C 15

Appendix 25 / 25