



DECLARATION OF PERFORMANCE



No. 0016 – EN

1. Unique identification code of the product-type: **fischer concrete screw FBS 5 and FBS 6**

2. Intended use/es:

Product	Intended use/es
Metal anchors for use in concrete (light-duty type)	For use in redundant systems for fixing and/or supporting to concrete elements such as lightweight suspended ceilings, as well as installations, see appendix, especially Annexes B 1 to B 4

3. Manufacturer: **fischerwerke GmbH & Co. KG, Klaus-Fischer-Straße 1, 72178 Waldachtal, Germany**

4. Authorised representative: --

5. System/s of AVCP: **2+**

6a. Harmonised standard: ---

Notified body/ies: ---

6b. European Assessment Document: **ETAG 001; 2010-08**

European Technical Assessment: **ETA-11/0093; 2015-08-28**

Technical Assessment Body: **DIBt**

Notified body/ies: **1343 – MPA Darmstadt**

7. Declared performance/s:

Safety in case of fire (BWR 2)

Essential characteristic	Performance
Reaction to fire	Anchorage satisfy requirements for Class A 1
Resistance to fire	See appendix, especially Annex C 2

Safety in use (BWR 4)

Essential characteristic	Performance
Characteristic resistance for tension and shear loads as well as bending moments in concrete	See appendix, especially Annexes C 1 and C 2
Edge distances and spacing	See appendix, especially Annex C 1

8. Appropriate Technical Documentation and/or Specific Technical Documentation: ---

The performance of the product identified above is in conformity with the set of declared performance/s. This declaration of performance is issued, in accordance with Regulation (EU) No 305/2011, under the sole responsibility of the manufacturer identified above.

Signed for and on behalf of the manufacturer by:

Andreas Bucher, Dipl.-Ing.

Wolfgang Hengesbach, Dipl.-Ing., Dipl.-Wirtsch.-Ing.

Tumlingen, 2015-09-04

- This DoP has been prepared in different languages. In case there is a dispute on the interpretation the english version shall always prevail.

- The Appendix includes voluntary and complementary information in English language exceeding the (language-neutrally specified) legal requirements.

Specific Part

1 Technical description of the product

The Fischer concrete screw FBS in size of 5 and 6 is an anchor made of zinc-plated steel respectively steel with zinc flake coating (FBS) or made of stainless steel (FBS A4, FBS C). The anchor is screwed into a predrilled cylindrical drill hole. The special thread of the anchor cuts an internal thread into the member while setting. The anchorage is characterised by mechanical interlock in the special thread.

Product and product description is given in Annex A.

2 Specification of the intended use in accordance with the applicable European Assessment Document

The performances given in Section 3 are only valid if the anchor is used in compliance with the specifications and conditions given in Annex B.

The verifications and assessment methods on which this European Technical Assessment is based lead to the assumption of a working life of the anchor of at least 50 years. The indications given on the working life cannot be interpreted as a guarantee given by the producer, but are to be regarded only as a means for choosing the right products in relation to the expected economically reasonable working life of the works.

3 Performance of the product and references to the methods used for its assessment

3.1 Mechanical resistance and stability (BWR 1)

The essential characteristics regarding mechanical resistance and stability are included under the Basic Works Requirement Safety in use.

3.2 Safety in case of fire (BWR 2)

Essential characteristic	Performance
Reaction to fire	Anchorage satisfies requirements for Class A1
Resistance to fire	See Annex C 2

3.3 Safety in use (BWR 4)

Essential characteristic	Performance
Characteristic resistance for tension and shear loads as well as bending moments in concrete	See Annex C 1 and C 2
Edge distances and spacing	See Annex C 1

4 Assessment and verification of constancy of performance (AVCP) system applied, with reference to its legal base

In accordance with guideline for European technical approval ETAG 001, April 2013 used as European Assessment Document (EAD) according to Article 66 Paragraph 3 of Regulation (EU) No 305/2011 the applicable European legal act is: [97/161/EC].

The system to be applied is: 2+

product and installed condition

fischer concrete screw FBS 5 and FBS 6

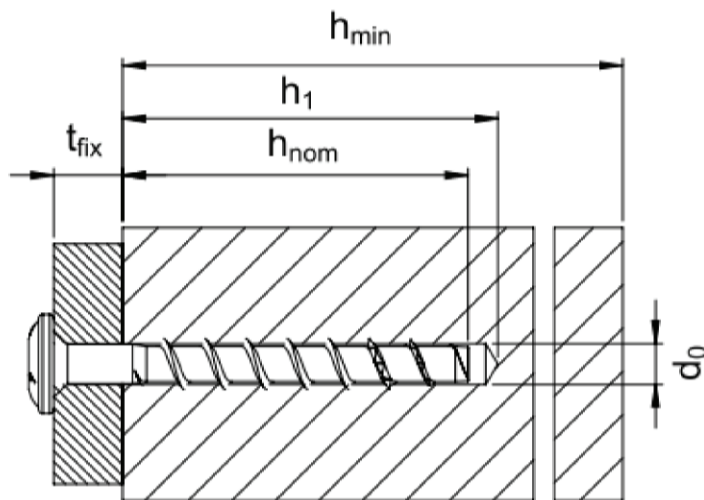
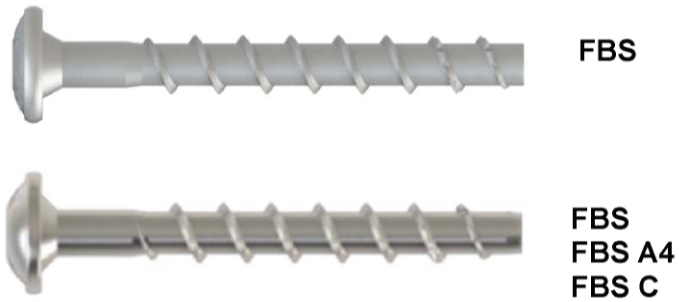

- d_0 = nominal drill bit diameter
- h_{nom} = nominal anchorage depth
- h_1 = depth of the drill hole
- h_{min} = minimum thickness of member
- t_{fix} = thickness of fixture

fischer concrete screw FBS

Product description

Installed condition

Annex A 1

installed condition in precast prestressed hollow core slabs

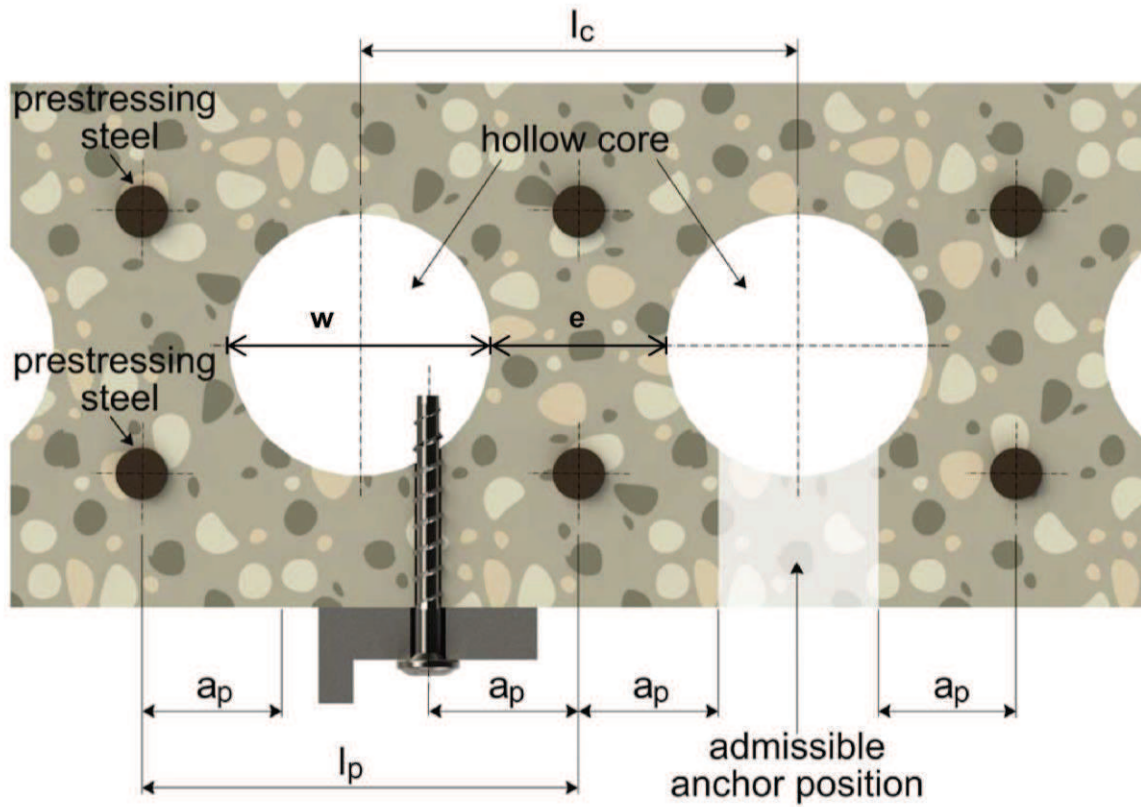

$$w / e \leq 4,2$$

fischer concrete screw FBS

















Product description

Installed condition

Annex A 2

Table A 1: materials and variants

part	name	Material		
1, 2, 3, 4, 5, 6, 7, 8	Screw anchor	FBS	Steel EN 10263-4 galvanized acc. to EN ISO 4042 or zinc flake coating acc. to EN ISO 10683 ($\geq 5\mu\text{m}$)	
		FBS A4	1.4401, 1.4404, 1.4571, 1.4578	
		FBS C	1.4529	
		nominal characteristic steel yield strength	f_{yk} [N/mm ²]	600
		nominal characteristic steel ultimate strength	f_{uk} [N/mm ²]	700

		1)	Anchor version with connection thread
		2)	Anchor version with washer, hexagon head and TORX
		3)	Anchor version with washer, hexagon head and
		4)	Anchor version with hexagon head
		5)	Anchor version with countersunk head
		6)	Anchor version with pan head
		7)	Anchor version with countersunk head and connection thread
		8)	Anchor version with hexagon head and connection thread

fischer concrete screw FBS

Product description

Material and screw types

Annex A 3

Table A 2: dimensions and markings

Anchor size			FBS 5	FBS 6
Length of the anchor	$L \leq$	[mm]	200	
Diameter of shaft	d_k	[mm]	4,2	5,2
Diameter of thread	d_s	[mm]	6,5	7,5

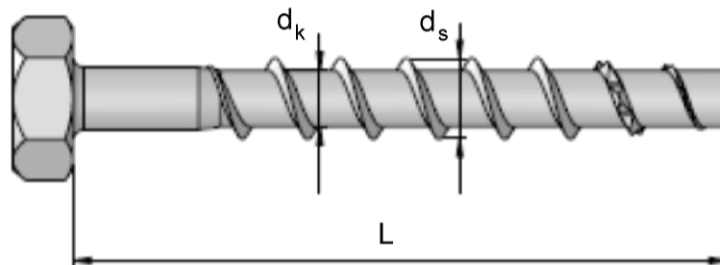

Marking:

Anchor type: FBS / TSM B or TSM BC
FBS A4 / TSM BS
FBS C / TSM BSH

Anchor size: 6
Length of the anchor: 60



Marking "k" or "x" for anchors with connection thread and $h_{nom} = 35$ mm

fischer concrete screw FBS

Product descriptions

Dimensions and markings

Annex A 4

Intended use

Anchorage subject to:

- static and quasi static loads
- Used only for multiple use for non-structural application according to ETAG 001, Part 6
- Used for anchorages in prestressed hollow core slabs
- Used for anchorages with requirements related to resistance of fire (not for using in prestressed hollow core slabs)

Base materials:

- reinforced and unreinforced concrete according to EN 206-1:2000
- strength classes C20/25 to C50/60 according to EN 206-1:2000
- cracked and non-cracked concrete

Use conditions (Environmental conditions):

- The anchor may only be used in dry internal conditions: All screw types
- Structural subject to external atmospheric exposure (including industrial and marine environment) and to permanently damp internal condition no particular aggressive conditions exists: screw types made of stainless steel with marking A4 or BS
- Structural subject to external atmospheric exposure (including industrial and marine environment) and to permanently damp internal condition if particular aggressive conditions exists: screw types made of stainless steel with marking C or BSH

Note: Such particular aggressive conditions are e.g. permanent, alternating immersion in seawater or the splash zone of seawater, chloride atmosphere of indoor swimming pools or atmosphere with chemical pollution (e.g. in desulphurization plants or road tunnels where de-icing materials are used)

Design:

- Anchorages are designed under the responsibility of an engineer experienced in anchorages and concrete work.
- Verifiable calculation notes and drawings are prepared taking account of the loads to be anchored. The position of the anchor is indicated on the design drawings (e.g. position of the anchor relative to reinforcement or to supports, etc.).
- Anchorages under static or quasi-static actions are designed for design method A in accordance with:
 - ETAG 001, Annex C, Edition August 2010 or
 - CEN/TS 1992-4:2009.
- Anchorages under fire exposure are designed in accordance with:
 - EOTA Technical Report TR 020, Edition May 2004 or
 - CEN/TS 1992-4:2009, Annex D (It must be ensured that local spalling of the concrete cover does not occur).

Installation:

- Hammer drilling only.
- Anchor installation carried out by appropriately qualified personal and under the supervision of the person responsible for technical matters of the site.
- After installation further turning of the anchor is not possible. The head of the anchor is supported on the fixture and is not damaged.

fischer concrete screw FBS

Intended use

Specifications

Annex B 1

Table B 1: Installation parameters

Anchorsize			FBS 5	FBS 6	
Nominal embedment depth			$h_{nom} = 35 \text{ mm}$	$h_{nom} = 35 \text{ mm}$	$h_{nom} = 55 \text{ mm}$
nominal drill bit diameter	d_0	[mm]	5	6	
cutting diameter of drill bit	$d_{cut} \leq$	[mm]	5,40	6,40	
depth of drill hole	$h_1 \geq$	[mm]	40	40	60
Nominal embedment depth	$h_{nom} \geq$	[mm]	35	35	55
diameter of clearing hole in the fixture	$d_f \leq$	[mm]	7	8	
Installation torque	T_{inst}	Nm	8	10	
Maximum nominal torque for installation with an impact screwdriver		Nm	120	150	

Table B 2: Minimum thickness of member, minimum edge distance and minimum spacing

Anchorsize			FBS 5	FBS 6	
Nominal embedment depth			$h_{nom} = 35 \text{ mm}$	$h_{nom} = 35 \text{ mm}$	$h_{nom} = 55 \text{ mm}$
minimum thickness of member	h_{min}	[mm]	80	80	100
minimum edge distance	c_{min}	[mm]	35	35	40
minimum spacing	s_{min}	[mm]	35	35	40

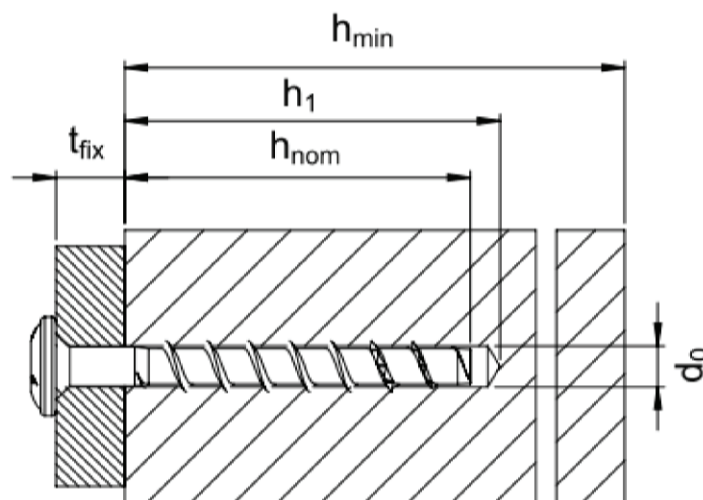

fischer concrete screw FBS

Intended use

Installation parameters

Annex B 2

Installation parameters for anchorages in precast prestressed hollow core slabs

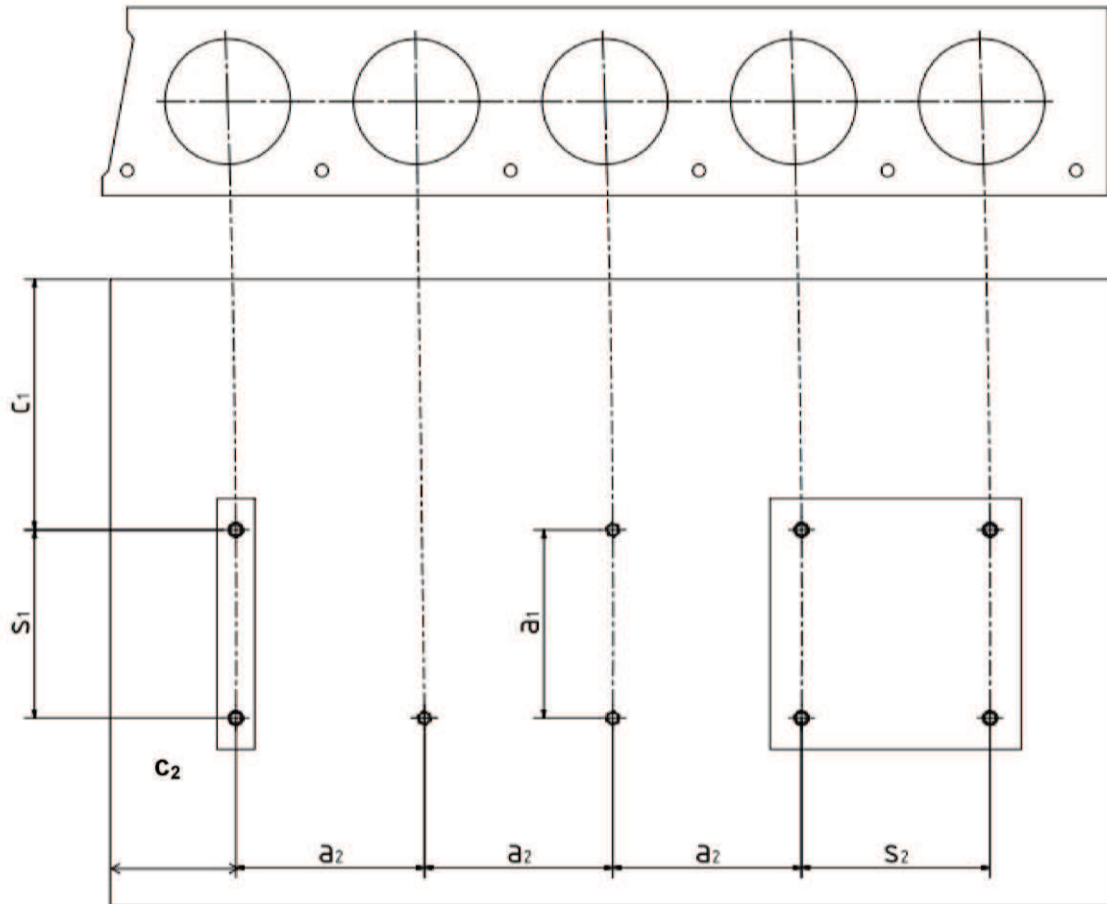

c_1, c_2 edge distance
 s_1, s_2 anchor spacing
 a_1, a_2 distance between anchor groups

Minimum edge distance	c_{min}	≥ 100 mm
Minimum anchor spacing	s_{min}	≥ 100 mm
Minimum distance between anchor groups	a_{min}	≥ 100 mm

fischer concrete screw FBS

Intended use

Installation parameters for anchorages in precast prestressed hollow slabs

Annex B 3

Installation instructions

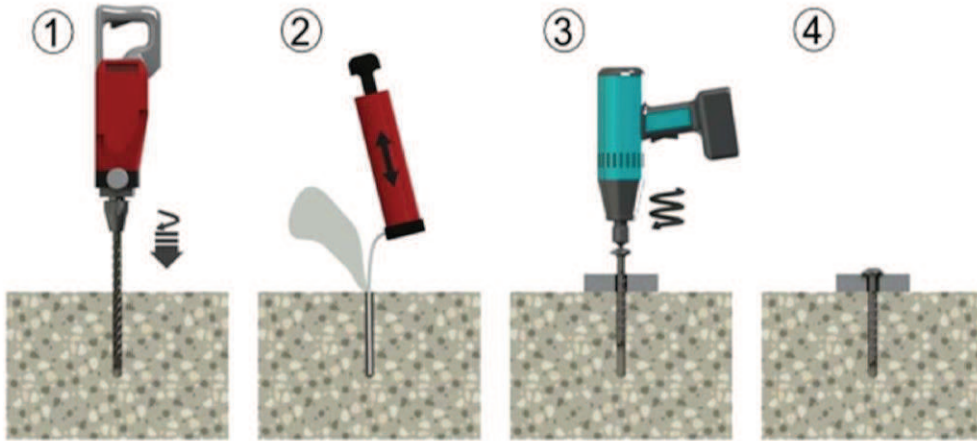

Installation instructions for anchorages in prestressed hollow slabs

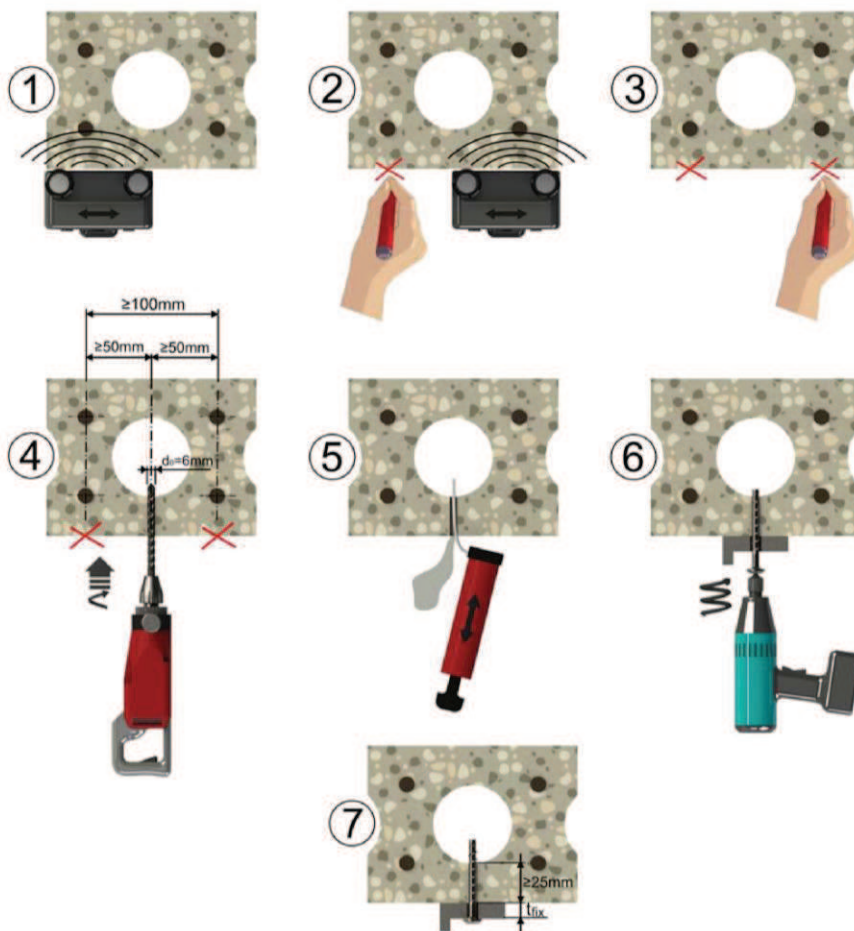

fischer concrete screw FBS

Intended use

Installation instructions

Annex B 4

**Table C 1: Characteristic values for design method A according to ETAG 001, Annex C
or CEN/TS 1992-4**

Anchorsize			FBS 5	FBS 6	
Nominal embedment depth			$h_{nom} = 35 \text{ mm}$	$h_{nom} = 35 \text{ mm}$	$h_{nom} = 55 \text{ mm}$
steel failure for tension- and sear load					
characteristic load	$N_{RK,s}$	[kN]	8,7	13,7	
	$V_{RK,s}$	[kN]	4,4	7,0	
	$M_{RK,s}^0$	[Nm]	5,3	10,0	
pull-out failure					
characteristic tension load in concrete C20/25	$N_{RK,p}$	[kN]	1,5	1,5	7,5
increasing factor concrete for $N_{RK,p}$	Ψ_C	C30/37	1,22		
		C40/50	1,41		
		C50/60	1,55		
concrete cone and splitting failure					
effective anchorage depth	h_{ef}	[mm]	27	27	44
factor for	cracked	$k_{cr}^{1)}$	[-]	7,2	
	non cracked	$k_{ucr}^{1)}$	[-]	10,1	
concrete cone failure	spacing	$s_{cr,N}$	[mm]	$3 \times h_{ef}$	
	edge distance	$c_{cr,N}$	[mm]	$1,5 \times h_{ef}$	
splitting failure	spacing	$s_{cr,Sp}$	120	120	160
	edge distance	$c_{cr,Sp}$	60	60	80
installation safety factor	$\gamma_2^{1)} = \gamma_{inst}^{2)}$	[-]	1,2	1,2	1,0
concrete pry out failure (pry-out)					
k-Factor	$k^{1)} = k_3^{2)}$	[-]	1,0		
concrete edge failure					
effective length of anchor	$l_f = h_{ef}$	[mm]	27	27	44
outside diameter of anchor	d_{nom}	[mm]	5	6	

¹⁾ Parameter relevant only for design according to CEN/TS 1992-4:2009

²⁾ Parameter relevant only for design according ETAG 001 Annex C

fischer concrete screw FBS

Performances

Characteristic values for design method A

Annex C 1

**Table C2: Characteristic values of resistance in precast prestressed hollow core slabs
C30/37 to C50/60**

Anchorsize			FBS 6		
bottom flange thickness	d_b	[mm]	≥ 25	≥ 30	≥ 35
characteristic resistance	F_{Rk}	[kN]	1	2	3
installation safety factor	$\gamma_2^{1)} = \gamma_{inst}^{2)}$	[mm]	1,2		

¹⁾ Parameter relevant only for design according to CEN/TS 1992-4:2009

²⁾ Parameter relevant only for design according ETAG 001 Annex C

Table C 3: Characteristic values of resistance to fire exposure ¹⁾

Anchorsize				FBS 6		
Nominal embedment depth				$h_{nom} = 35 \text{ mm}$	$h_{nom} = 55 \text{ mm}$	
fire resistance class						
R 30	characteristic resistance	$F_{Rk,fi30}$	[kN]	0,38	0,9	1,2
R 60	characteristic resistance	$F_{Rk,fi60}$	[kN]	0,38	0,8	1,2
R 90	characteristic resistance	$F_{Rk,fi90}$	[kN]	0,38	0,6	1,2
R 120	characteristic resistance	$F_{Rk,fi120}$	[kN]	0,30	0,4	0,8
R 30 bis R 120	spacing	$s_{cr,fi}$	[mm]	108	176	
	edge distance	$c_{cr,fi}$		54	88	

¹⁾ Not for using in prestressed hollow core slabs

fischer concrete screw FBS

Performances

Characteristic values for anchorages in precast prestressed hollow core slabs and characteristic values of resistance to fire exposure

Annex C 2