



DECLARACIÓN DE PRESTACIONES



no 0025 – ES

1. Código de identificación única del producto tipo: **fischer Sistema de inyección Mampostería FIS P Plus**

2. Usos previstos:

producto	Uso/s previsto/s
anclaje de inyección para aplicaciones en fábrica de ladrillo	Anclajes para los cuales se cumplen los requisitos de resistencia mecánica y estabilidad y seguridad durante el uso. Están destinados a la fijación y/o el soporte de elementos estructurales (que contribuyen a la estabilidad de las obras) o unidades pesadas, Véase el apéndice, especialmente los anexos B 1 - B 10

3. Fabricante: **fischerwerke GmbH & Co. KG, Klaus-Fischer-Straße 1, 72178 Waldachtal, Germany**

4. Representante autorizado: --

5. Sistemas de evaluación y verificación de la constancia de las prestaciones (EVCP): **1**

6a. Norma armonizada: ---

Organismos notificados: ---

6b. Documento de evaluación europeo: **ETAG 029; 2013-04**

Evaluación técnica europea: **ETA-11/0419; 2015-10-30**

Organismo de evaluación técnica: **DIBt**

Organismos notificados: **1343 – MPA Darmstadt**

7. Prestaciones declaradas:

Resistencia mecánica y estabilidad (BWR 1)

indicación esencial	Prestaciones
valores característicos para solicitaciones a tracción y a cortante	Ver anexo, especialmente anexo C 1 - C 4
momentos flectores característicos	Ver anexo, especialmente anexo C 5
desplazamientos bajo solicitaciones a tracción y a cortante	Ver anexo, especialmente anexo C 5
coeficiente de reducción para ensayos a pie de obra (β -coeficiente)	Ver anexo, especialmente anexo C 6
distancias al borde y entre ejes	Ver anexo, especialmente anexo C 7 - C 8

protección contra incendios (BWR 2)

indicación esencial	Prestaciones
Reacción al fuego	el anclaje cumple con las exigencias de la clase A1.
resistencia al fuego	SRD

8. Documentación técnica adecuada o documentación técnica específica: ---

Las prestaciones del producto identificado anteriormente son conformes con el conjunto de prestaciones declaradas. La presente declaración de prestaciones se emite, de conformidad con el Reglamento (UE) no 305/2011, bajo la sola responsabilidad del fabricante arriba identificado.

Firmado por y en nombre del fabricante por:

Andreas Bucher, Dipl.-Ing.

Wolfgang Hengesbach, Dipl.-Ing., Dipl.-Wirtsch.-Ing.

Tumlingen, 2015-11-06

- Este DoP ha sido redactado en varios idiomas. En caso de disputa acerca de la interpretación siempre prevalecerá la versión en inglés.

- el anexo contiene información voluntaria y complementaria en inglés, que va más allá de las exigencias legales.

Specific Part

1 Technical description of the product

The fischer injectionsystem FIS P Plus for masonry is a bonded anchor (injection type) consisting of a mortar cartridge with injection mortar fischer FIS P Plus, FIS P Plus Low Speed and FIS P Plus High Speed, a perforated sieve sleeve and an anchor rod with hexagon nut and washer or an internal threaded rod. The steel elements are made of zinc coated steel, stainless steel or high corrosion resistant steel.

The anchor rod is placed into a drilled hole filled with injection mortar and is anchored via the bond between steel element, injection mortar and masonry and mechanical interlock.

The product description is given in Annex A.

2 Specification of the intended use in accordance with the applicable European Assessment Document

The performances given in Section 3 are only valid if the anchor is used in compliance with the specifications and conditions given in Annex B.

The verifications and assessment methods on which this European Technical Assessment is based lead to the assumption of a working life of the anchor of at least 50 years. The indications given on the working life cannot be interpreted as a guarantee given by the producer, but are to be regarded only as a means for choosing the right products in relation to the expected economically reasonable working life of the works.

3 Performance of the product and references to the methods used for its assessment

3.1 Mechanical resistance and stability (BWR 1)

Essential characteristic	Performance
Characteristic resistance for tension and shear loads	See Annex C 1 – C 4
Characteristic resistance for bending moments	See Annex C 5
Displacements under shear and tension loads	See Annex C 5
Reduction Factor for job site tests (β -Factor)	See Annex C 6
Edge distances and spacing	See Annex C 7 – C8

3.2 Safety in case of fire (BWR 2)

Essential characteristic	Performance
Reaction to fire	Anchorage satisfy requirements for Class A1
Resistance to fire	No performance assessed

3.3 Hygiene, health and the environment (BWR 3)

Regarding dangerous substances there may be requirements (e.g. transposed European legislation and national laws, regulations and administrative provisions) applicable to the products falling within the scope of this European Technical Assessment. In order to meet the provisions of Regulation (EU) No 305/2011, these requirements need also to be complied with, when and where they apply.

3.4 Safety in use (BWR 4)

The essential characteristics regarding Safety in use are included under the Basic Works Requirement Mechanical resistance and stability.

4 Assessment and verification of constancy of performance (AVCP) system applied, with reference to its legal base

In accordance with guideline for European technical approval ETAG 029, April 2013 used as European Assessment Document (EAD) according to Article 66 Paragraph 3 of Regulation (EU) No 305/2011 the applicable European legal act is: [97/177/EC].

The system to be applied is: 1

Installation conditions part 1;

Threaded rods with perforated sleeve FIS H K; Installation in perforated and solid brick masonry

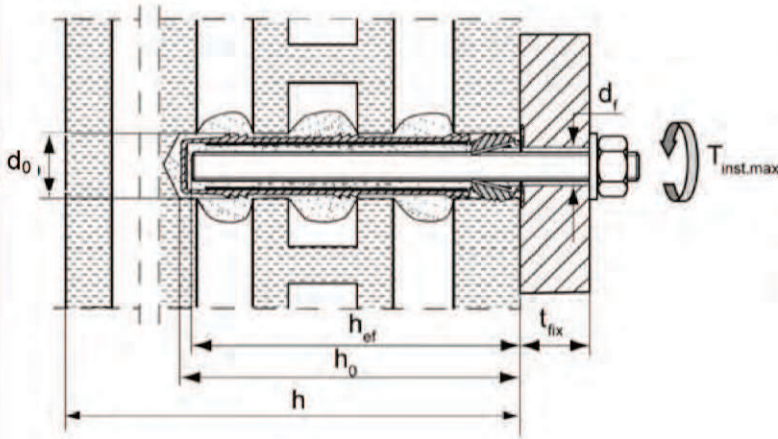

Pre-positioned installation

- FIS H 12x85 K
- FIS H 16x85 K
- FIS H 16x130 K
- FIS H 20x85 K
- FIS H 20x130 K
- FIS H 20x200 K

Internal threaded anchors FIS E with perforated sleeve FIS H K; Installation in perforated and solid brick masonry

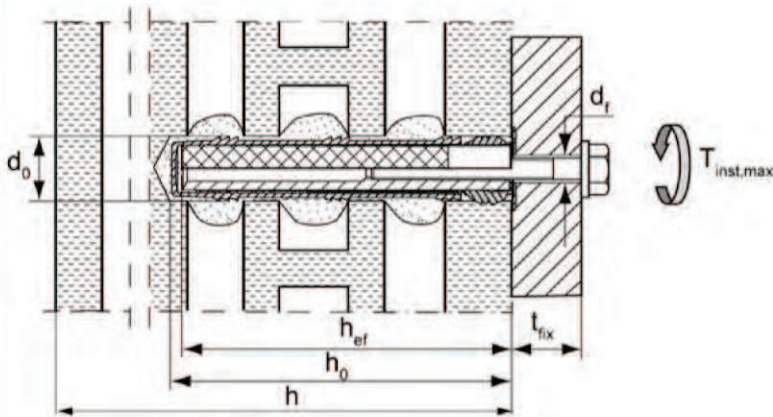

Pre-positioned installation

- FIS H 16x85 K – FIS E 11x85 M6 and M8
- FIS H 20x85 K- FIS E 15x85 M10 and M12

h_{ef} = effective anchorage depth
 h_0 = depth of drill hole
 t_{fix} = thickness of fixture
 h = thickness of masonry

d_0 = nominal drill bit diameter
 d_1 = diameter of clearance hole in the fixture
 $T_{inst,max}$ = maximum torque moment

fischer Injectionsystem FIS P Plus for masonry

Product description

Installation condition, part 1: in perforated and solid brick masonry

Annex A 1

Installation conditions part 2;

Threaded rods without perforated sleeve FIS H K; Installation in solid brick masonry and autoclaved aerated concrete

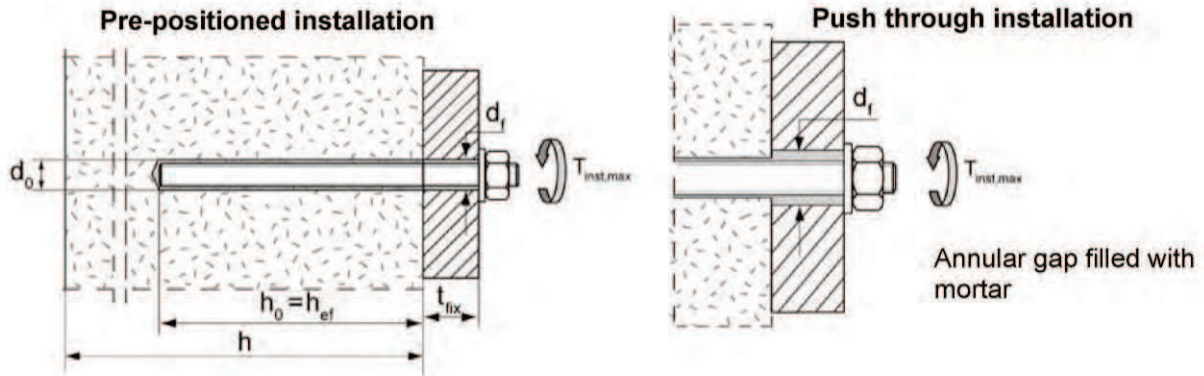

Internal threaded anchors FIS E without perforated sleeve FIS H K; Installation in solid brick masonry and autoclaved aerated concrete

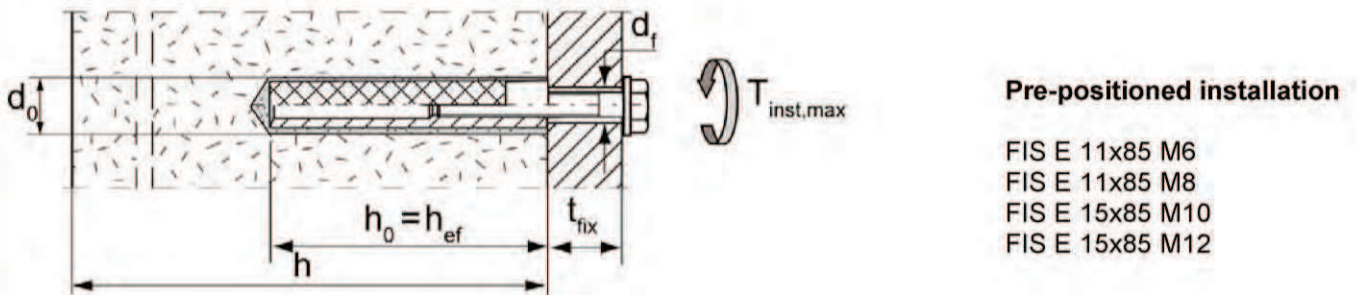

Pre-positioned installation

- FIS E 11x85 M6
- FIS E 11x85 M8
- FIS E 15x85 M10
- FIS E 15x85 M12

h_{ef} = effective anchorage depth
 h_0 = depth of drill hole
 t_{fix} = thickness of fixture
 h = thickness of masonry

d_0 = nominal drill bit diameter
 d_f = diameter of clearance hole in the fixture
 $T_{inst,max}$ = maximum torque moment

fischer Injectionsystem FIS P Plus for masonry

Product description

Installation condition, part 2: in solid brick masonry and aerated concrete

Annex A 2

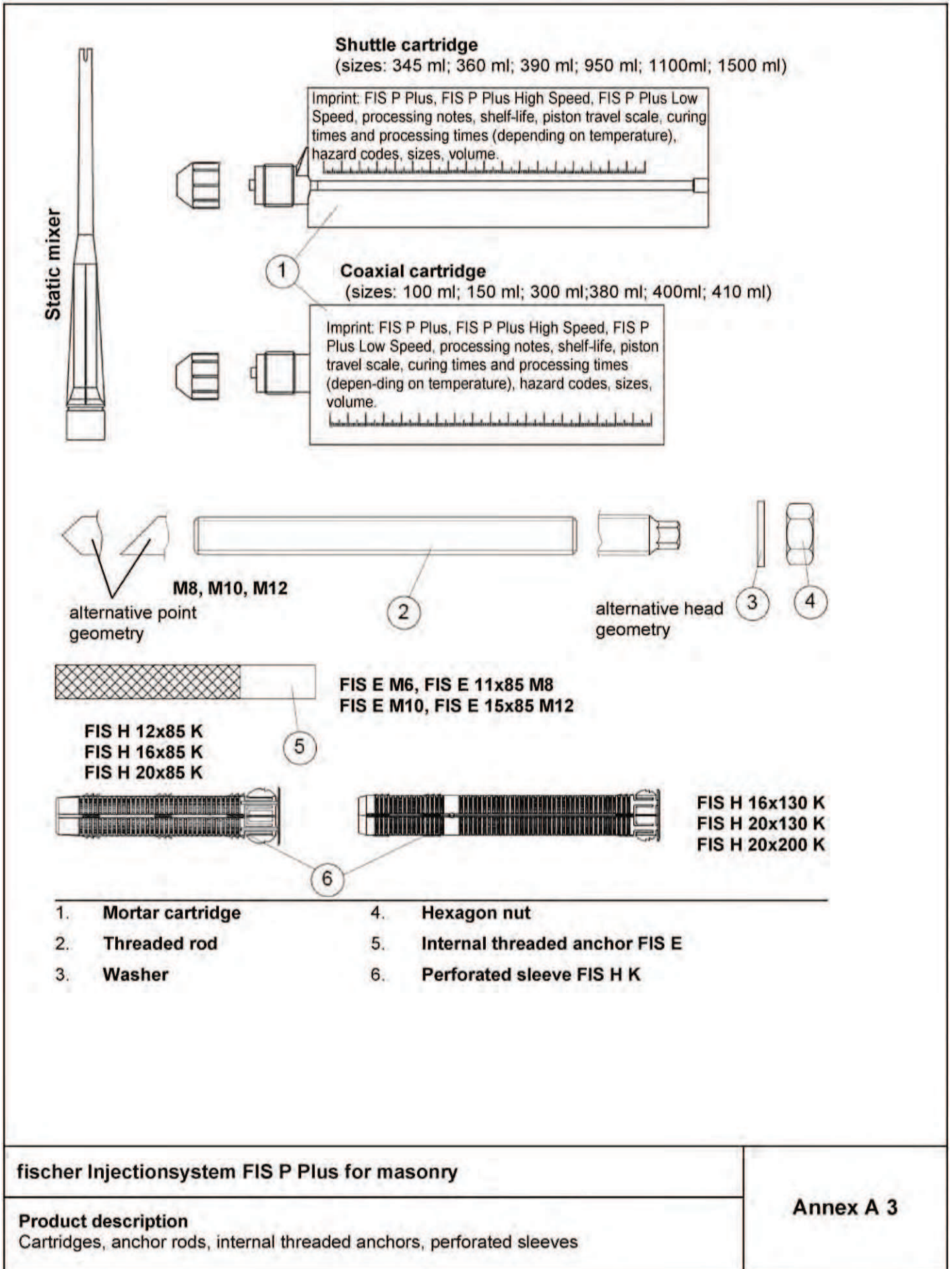

fischer Injectionsystem FIS P Plus for masonry

Product description

Cartridges, anchor rods, internal threaded anchors, perforated sleeves

Annex A 3

Table A1: Materials

Part	Designation	Material		
1	Mortar cartridge	mortar, hardener; filler		
		Steel, zinc plated	Stainless steel A4	High corrosion-resistant steel C
2	Threaded rod	Property class 5.8 or 8.8; EN ISO 898-1:2013 zinc plated $\geq 5\mu\text{m}$, EN ISO 4042:1999 A2K or hot-dip galvanised EN ISO 10684:2004 $f_{uk} \leq 1000 \text{ N/mm}^2$ $A_5 > 8\%$	Property class 50, 70 or 80 EN ISO 3506:2009 1.4401; 1.4404; 1.4578; 1.4571; 1.4439; 1.4362; 1.4062 EN 10088-1:2014 $f_{uk} \leq 1000 \text{ N/mm}^2$ $A_5 > 8\%$	Property class 50 or 80 EN ISO 3506:2009 or property class 70 with $f_{yk} = 560 \text{ N/mm}^2$ 1.4565; 1.4529 EN 10088-1:2014 $f_{uk} \leq 1000 \text{ N/mm}^2$ $A_5 > 8\%$
3	Washer ISO 7089:2000	zinc plated $\geq 5\mu\text{m}$, EN ISO 4042:1999 A2K or hot-dip galvanised ISO 10684:2004	1.4401; 1.4404; 1.4578; 1.4571; 1.4439; 1.4362 EN 10088-1:2014	1.4565; 1.4529 EN 10088-1:2014
4	Hexagon nut	Property class 5 or 8; EN ISO 898-2:2013 zinc plated $\geq 5\mu\text{m}$, ISO 4042:1999 A2K or hot-dip galvanised ISO 10684:2004	Property class 50, 70 or 80 ISO 3506:2009 1.4401; 1.4404; 1.4578; 1.4571; 1.4439; 1.4362 EN 10088-1:2014	Property class 50, 70 or 80 ISO 3506:2009 1.4565; 1.4529 EN 10088-1:2014
5	Internal threaded anchor FIS E	Property class 5.8; EN 10277-1:2008 zinc plated $\geq 5\mu\text{m}$, EN ISO 4042:1999 A2K	Property class 70 EN ISO 3506:2009 1.4401; 1.4404; 1.4578; 1.4571; 1.4439; 1.4362 EN 10088-1:2014	Property class 70 EN ISO 3506-1:2009 1.4565; 1.4529 EN 10088-1:2014
	Screw or threaded rod for internal threaded anchor FIS E	Property class 5.8 or 8.8; EN ISO 898-1:2013 zinc plated $\geq 5\mu\text{m}$, ISO 4042:1999 A2K	Property class 70 EN ISO 3506:2009 1.4401; 1.4404; 1.4578; 1.4571; 1.4439; 1.4362 EN 10088-1:2014	Property class 70 EN ISO 3506-1:2009 1.4565; 1.4529 EN 10088-1:2014
6	Perforated sleeve FIS H K	PP / PE		

fischer Injectionsystem FIS P Plus for masonry

Product description
Materials

Annex A 4

Specifications of intended use part 1

Anchorage subject to:

- Static and quasi-static loads

Base materials:

- Solid brick masonry (Use category b) and autoclaved aerated concrete (Use category d), acc. to Annex B8.
Note: The characteristic resistance is also valid for larger brick sizes and higher compressive strength of the masonry unit.
- Hollow brick masonry (use category c), according to Annex B8
- Mortar strength class of the masonry M2,5 at minimum according to EN 998-2:2010
- For other bricks in solid masonry, hollow or perforated masonry and autoclaved aerated concrete, the characteristic resistance of the anchor may be determined by job site tests according to ETAG 029, Annex B under consideration of the β -factor according to Annex C6, Table C4

Temperature Range:

- I: From - 40°C to +80°C (max. short term temperature +80°C and max. long term temperature +50°C)

Use conditions (Environmental conditions):

- Dry and wet structure (regarding injection mortar)
- Structures subject to dry internal conditions exist
(zinc coated steel, stainless steel or high corrosion resistant steel)
- Structures subject to external atmospheric exposure including industrial and marine environment or exposure to permanently damp internal condition, if no particular aggressive conditions exist
(stainless steel or high corrosion resistant steel)
- Structures subject to external atmospheric exposure and to permanently damp internal condition, if other particular aggressive conditions exist (high corrosion resistant steel)
Note: Particular aggressive conditions are e.g. permanent, alternating immersion in seawater or the splash zone of seawater, chloride atmosphere of indoor swimming pools or atmosphere with extreme chemical pollution (e.g. in desulphurization plants or road tunnels where de-icing materials are used)

fischer Injectionsystem FIS P Plus for masonry

Intended Use
Specifications part 1

Annex B 1

Specifications of intended use part 2

Design:

- The anchorages have to be designed in accordance with the ETAG 029, Annex C, Design method A under the responsibility of an engineer experienced in anchorages and masonry work

Applies to all bricks, if no other values are specified:

$$N_{Rk} = N_{Rk,s} = N_{Rk,p} = N_{Rk,b} = N_{Rk,pb}$$

$$V_{Rk} = V_{Rk,s} = V_{Rk,b} = V_{Rk,c} = V_{Rk,pb}$$

- Verifiable calculation notes and drawings have to be prepared taking account the relevant masonry in the region of the anchorage, the loads to be transmitted and their transmission to the supports of the structure. The position of the anchor is indicated on the design drawings

Installation:

- Category d/d: -Installation and use in dry structures
- Category w/w: -Installation and use in dry and wet structures
- Hole drilling by hammer drill mode
- In case of aborted hole: The hole shall be filled with mortar
- Bridging of unbearing layer (e.g. plaster) see Annex B 4 (Table B1.3)
- Anchor installation carried out by appropriately qualified personnel and under the supervision of the person responsible for technical matters of the site
- Fastening screws or threaded rods (including nut and washer) must comply with the appropriate material and property class of the fischer internal threaded anchor FIS E
- minimum curing time see Annex B5. Table B3
- Commercial standard threaded rods, washers and hexagon nuts may also be used if the following requirements are fulfilled:

Material dimensions and mechanical properties of the metal parts according to the specifications are given in Annex A4, Table A1

Conformation of material and mechanical properties of the metal parts by inspection certificate 3.1 according to EN 10204:2004, the documents shall be stored

Marking of the threaded rod with the envisage embedment depth. This may be done by the manufacturer of the rod **or** by a person on job site

fischer Injectionsystem FIS P Plus for masonry

Intended Use
Specifications part 2

Annex B 2

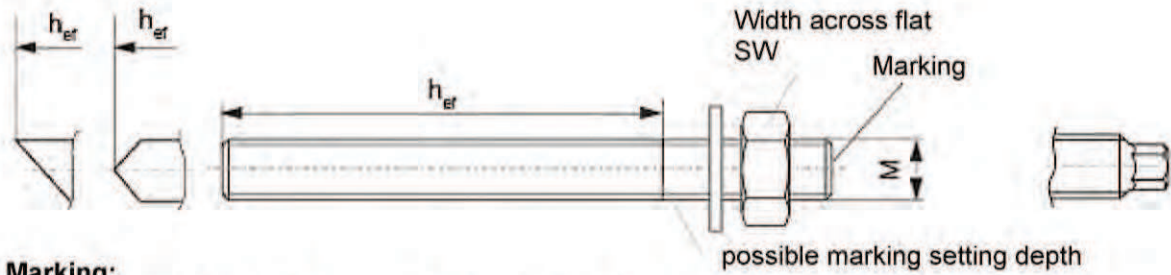

Marking:

Property class 8.8 or high corrosion-resistant steel C, property class 80: •
 Stainless steel A4, property class 50 and high corrosion-resistant steel C, property class 50: ••

Table B1.1: Installation parameters for threaded rod without perforated sleeve

Size		M8	M10	M12	
Nominal drill hole diameter	$d_{nom}=d_0$ [mm]	10	12	14	
Width across flat	SW [mm]	13	17	19	
Effective anchorage depth ¹⁾	$h_{ef,min}$ [mm]	50			
Depth of drill hole $h_0 = h_{ef}$	$h_{ef,max}$ [mm]	h-30 and ≤ 200 mm			
Effective anchorage depth AAC	$h_{ef,min}$ [mm]	100			
	$h_{ef,max}$ [mm]	120			
Maximum torque moment	$T_{inst,max}$ [Nm]	10			
Max. torque moment for autoclaved aerated concrete	$T_{inst,max}$ [Nm]	1	2		
Diameter of clearance hole in the fixture	Pre-position anchorage	$d_f \leq$ [mm]	9	12	14
	Push through anchorage	$d_f \leq$ [mm]	11	14	16

¹⁾ $h_{ef,min} \leq h_{ef} \leq h_{ef,max}$ is possible.

fischer internal threaded anchor FIS E

FIS E 11x85 M6, FIS E 11x85 M8

FIS E 15x85 M10, FIS E 15x85 M12

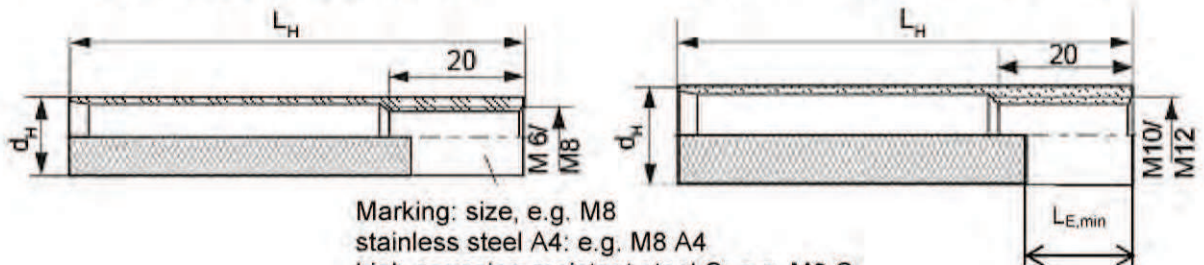

Marking: size, e.g. M8
 stainless steel A4: e.g. M8 A4
 high corrosion-resistant steel C: e.g. M8 C

Table B1.2: Installation parameters for internal threaded anchor FIS E without perforated sleeve

Size FIS E		M6	M8	M10	M12
diameter of internal threaded anchor	d_H [mm]	11		15	
Nominal drill hole diameter	$d_{nom}=d_0$ [mm]	14		18	
Depth of drill hole	h_0 [mm]	85			
Effective anchorage depth	$L_H=h_{ef}$ [mm]	85			
Maximum torque moment	$T_{inst,max}$ [Nm]	4	10		
Max. torque moment for autoclaved aerated concrete	$T_{inst,max}$ [Nm]	1		2	
Diameter of clearance hole in the fixture	$d_f \leq$ [mm]	7	9	12	14
	Screw-in depth	$L_{E,min}$ [mm]	6	8	10

fischer Injectionsystem FIS P Plus for masonry

Intended Use
 Installation parameters, part 1

Annex B 3

Perforated sleeves FIS H 12x85; 16x85; 16x130; 20x85; 20x130; 20x200 K

Marking: size
 $D_{\text{Sleeve}} \times L_{\text{Sleeve}}$
 e.g. 16x85

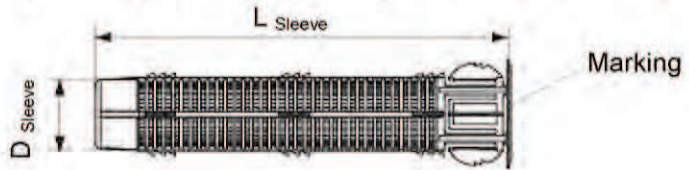

Table B1.3: Installation parameters (threaded rod and internal threaded anchor with perforated sleeve; only pre-positioned anchorage)

Size FIS H...K	12x85	16x85	16x130 ²⁾	20x85	20x130 ²⁾	20x200 ²⁾	
Nominal drill hole diameter ($d_0 = D_{\text{Sleeve}}$)	$d_{\text{nom}}=d_0$ [mm]	12	16		20		
Depth of drill hole	h_0 [mm]	90	90	135	90	135	205
Effective anchorage depth ¹⁾	$h_{\text{ef, min}}$ [mm]	85	85	110	85	110	180
	$h_{\text{ef, max}}$ [mm]	85	85	130	85	130	200
Size of threaded rod	[-]	M8	M8, M10		M12		
Size of internal threaded anchor	[-]	---	FIS E 11x85 M6/M8	---	FIS E 15x85 M10/M12	---	---
Maximum torque moment threaded rod and internal threaded anchor	$T_{\text{inst, max}}$ [mm]	2					

¹⁾ $h_{\text{ef, min}} \leq h_{\text{ef}} \leq h_{\text{ef, max}}$ is possible.

²⁾ Bridging of unbearing layer (e.g. plaster) possible

Steel brush BS



Only for solid bricks and aerated concrete

Table B2: Parameters of steel brush

Drill hole diameter	d_0	[mm]	10	12	14	16	18	20
Brush diameter	$d_{b,nom}$	[mm]	11	14	16	20	20	25

Table B3: Maximum processing time of the mortar and minimum curing time

(During the curing time of the mortar the masonry temperature may not fall below the listed minimum temperature).

Temperature at anchoring base [°C]	Minimum curing time ¹⁾ t_{cure} [minutes]		
	FIS P Plus High Speed ³⁾	FIS P Plus ²⁾	FIS P Plus Low Speed ²⁾
-10 to -5	12 hours		
>-5 to ±0	3 hours	24 hours	
>±0 to +5	90	3 hours	6 hours
>+5 to +10	45	90	3 hours
>+10 to +20	30	60	2 hours
>+20 to +30		45	60
>+30 to +40		35	30

System-temperature (mortar) [°C]	Maximum processing time t_{work} [minutes]		
	FIS P Plus High Speed ³⁾	FIS P Plus ²⁾	FIS P Plus Low Speed ²⁾
±0	5		
+5	5	13	20
+10	3	9	20
+20	1	5	10
+30		4	6
+40		2	4

¹⁾ For wet bricks the curing time must be doubled

²⁾ Minimum cartridge temperature +5°C

³⁾ Minimum cartridge temperature ±0°C











fischer Injectionsystem FIS P Plus for masonry

Intended Use
Steel brush
Processing times and curing times

Annex B 5

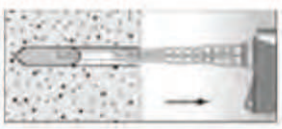
Installation instructions part 1

Installation and Preparing the cartridge in solid brick and autoclaved aerated concrete (without perforated sleeve)

1		<p>Drill the hole. Depth of drill hole h_0 and drill hole diameter d_0 see Table B1.1 or B1.2</p>		
2		<p>Blow out the drill hole two times by hand. Brush the drill hole two times using an adequate steel brush (see Table B2) and blow out two times again</p>		
3		<p>Remove the sealing cap</p>		<p>Screw on the static mixer (the spiral in the static mixer must be clearly visible)</p>
4		<p>Place the cartridge into a suitable dispenser.</p>		<p>Press out approximately 10 cm of material until the mortar is permanently grey in colour. Mortar which is not grey in colour will not cure and must be disposed off.</p>
5		<p>Fill approximately 2/3 of the drill hole with mortar. Always begin from the bottom of the hole to eliminate voids¹⁾.</p>		<p>For push through installation (not FIS E) fill the annular gap also with mortar.</p>
6		<p>Only use clean and oil-free anchor elements. Mark the threaded rod for setting depth. Press the threaded rod or internal threaded anchor FIS E down to the bottom of the hole, turning it slightly by hand while doing. After inserting the anchor element, excess mortar must emerge around the anchor element.</p>		
7		<p>Wait for the specified curing time t_{cure} see Table B3</p>		<p>Mounting the fixture $T_{inst,max}$ see Table B1.1 or B1.2</p>

¹⁾ For the exact quantity of mortar see manufacturer's specification.

fischer Injectionsystem FIS P Plus for masonry





Intended Use

Installation instructions part 1 in solid brick and aerated concrete

Annex B 6

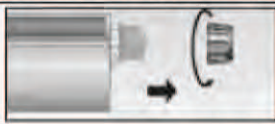
Installation instructions part 2

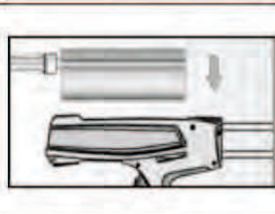
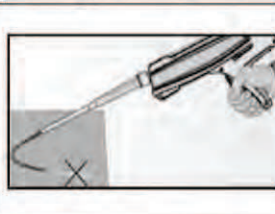
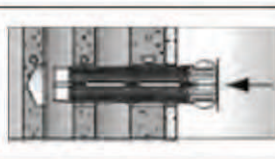
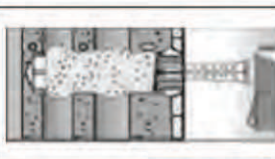
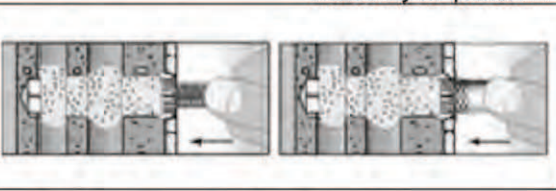
Installation in perforated or solid brick with perforated sleeve (pre-positioned anchorage)

1		<p>Drill the hole. Depth of drill hole h_0 and drill hole diameter d_0 see Table B1.3</p>	<p>When install perforated sleeves in solid bricks or solid areas of hollow bricks, also clean the hole by blowing out and brushing</p>	
2		<p>Remove the sealing cap</p>		<p>Screw on the static mixer (the spiral in the static mixer must be clearly visible)</p>
3		<p>Place the cartridge into a suitable dispenser</p>		<p>Press out approximately 10 cm of material until the mortar is permanently grey in colour. Mortar which is not grey in colour will not cure and must be disposed off</p>
4		<p>Insert the perforated sleeve flush with the surface of the masonry or plaster .</p>		<p>Fill the perforated sleeve completely with mortar beginning from the bottom of the hole¹⁾.</p>
5		<p>Only use clean and oil-free anchor elements. Mark the threaded rod for setting depth. Insert the threaded rod or the internal threaded anchor FIS E by hand using light turning motions until reaching the setting depth marking (threaded rod) or flush with the surface (internal threaded anchor).</p>		
6	 <p>Wait for the specified curing time t_{cure} see Table B3</p>	 <p>Mounting the fixture. $T_{inst,max}$ see Table B1.3</p>		





¹⁾ For the exact quantity of mortar see manufacturer's specification.

fischer Injectionsystem FIS P Plus for masonry

Intended Use
Installation instructions part 2 in hollow brick masonry

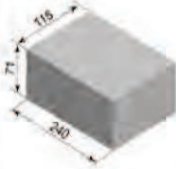
Annex B 7

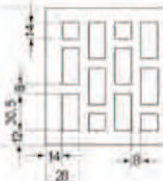
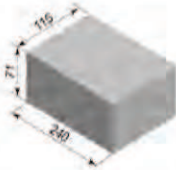
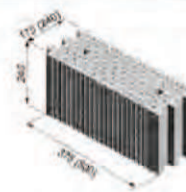
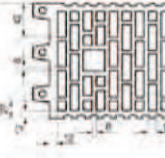
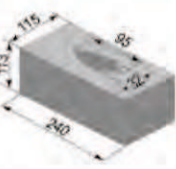
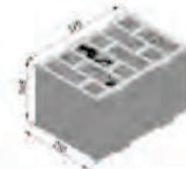
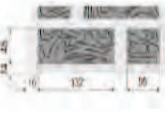
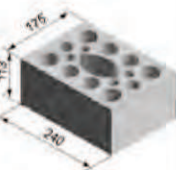
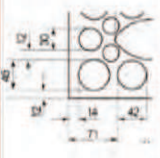
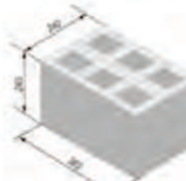
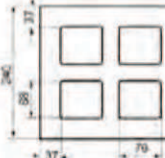
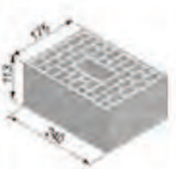
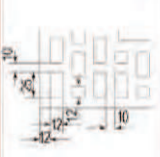
Table B 4: Summary of bricks and blocks

<p>Brick No. 1 Solid brick Mz according to EN 771-2 $\rho \geq 1,8$ [kg/dm³] $f_b \geq 10$ or 20 [N/mm²]</p>			<p>Brick No. 6 Perforated brick HLz according to EN 771-1 $\rho \geq 1,4$ [kg/dm³] $f_b \geq 20$ [N/mm²]</p>		
<p>Brick No. 2 Solid sand-lime brick according to EN 771-2 $\rho \geq 1,8$ [kg/dm³] $f_b \geq 10$ or 20 [N/mm²]</p>			<p>Brick No. 7 Perforated brick HLz according to EN 771-1 $\rho \geq 1,0$ [kg/dm³] $f_b \geq 10$ [N/mm²]</p>		
<p>Brick No. 3 Solid sand-lime brick according to EN 771-2 $\rho \geq 1,8$ [kg/dm³] $f_b \geq 10$ or 20 [N/mm²]</p>			<p>Brick No. 8 Perforated brick HLz filled with mineral wool according to EN 771-1 $\rho \geq 0,6$ [kg/dm³] $f_b \geq 8$ [N/mm²]</p>		
<p>Brick No. 4 Sand-lime hollow brick according to EN 771-2 $\rho \geq 1,4$ [kg/dm³] $f_b \geq 12$ or 20 [N/mm²]</p>			<p>Brick-No. 9 Light-weight concrete hollow block Hbl according to EN 771-1 $\rho \geq 1,0$ [kg/dm³] $f_b \geq 4$ [N/mm²]</p>		
<p>Brick No. 5 Perforated brick HLz according to EN 771-1 $\rho \geq 0,9$ [kg/dm³] $f_b \geq 10$ [N/mm²]</p>			<p>Brick No. 10 Autoclaved aerated concrete block $\rho \geq 350, 500$ or 650 [kg/dm³] $f_b \geq 2, 4$ or 6 [N/mm²]</p>		







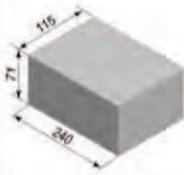

Imaging of the bricks are not scaled

fischer Injectionsystem FIS P Plus for masonry

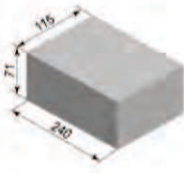
Intended Use
Types and dimensions of blocks and bricks

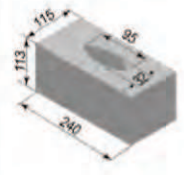
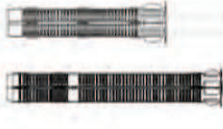
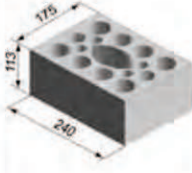
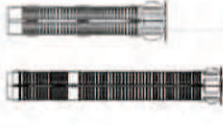
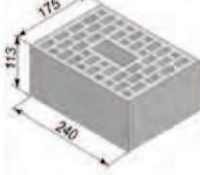
Annex B 8

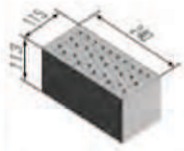
Table B5.1: Allocation of threaded rods¹⁾, perforated sleeves¹⁾²⁾ and perforated or solid bricks

Kind of masonry	Brick	Valid anchor rods and perforated sleeves	
Brick No. 1 Solid brick Mz according to EN 771-2 $\rho \geq 1,8$ [kg/dm ³] $f_b \geq 10$ or 20 [N/mm ²]			M8; M10; M12 FIS E 11x85 M6, M8
Brick No. 2 Solid sand-lime brick according to EN 771-2 $\rho \geq 1,8$ [kg/dm ³] $f_b \geq 10$ or 20 [N/mm ²]			M8; M10; M12 FIS E 11x85 M6, M8
Brick No. 3 Solid sand-lime brick according to EN 771-2 $\rho \geq 1,8$ [kg/dm ³] $f_b \geq 10$ or 20 [N/mm ²]			FIS H 12x85 K FIS H 16x85 K FIS H 20x85 K FIS H 16x130 K FIS H 20x130 K
Brick No. 4 Sand-lime hollow brick according to EN 771-2 $\rho \geq 1,4$ [kg/dm ³] $f_b \geq 12$ or 20 [N/mm ²]			FIS H 12x85 K FIS H 16x85 K FIS H 20x85 K FIS H 16x130 K FIS H 20x130 K
Brick No. 5 Perforated brick HLz according to EN 771-1 $\rho \geq 0,9$ [kg/dm ³] $f_b \geq 10$ [N/mm ²]			FIS H 12x85 K FIS H 16x85 K FIS H 20x85 K FIS H 16x130 K FIS H 20x130 K
Brick No. 6 Perforated brick HLz according to EN 771-1 $\rho \geq 1,4$ [kg/dm ³] $f_b \geq 20$ [N/mm ²]			FIS H 12x85 K FIS H 16x85 K FIS H 20x85 K

¹⁾ Other combinations can be used after job site tests acc. to ETAG 029, Annex B.

²⁾ Sleeve/anchor rod combination see table B1.3

The β - factor for this job site tests are given in Table C4

Imaging of the bricks are not scaled







fischer Injectionsystem FIS P Plus for masonry

Intended Use

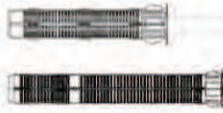
Allocation of threaded rods, perforated sleeves and bricks, part 1

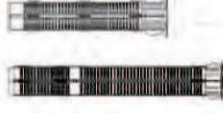
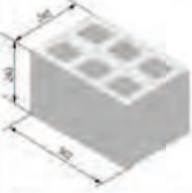
Annex B 9

Table B5.2: Allocation of threaded rods¹⁾, perforated sleeves¹⁾²⁾ and perforated or solid bricks

Kind of masonry	Brick	Valid anchor rods and perforated sleeves	
Brick No. 7 Perforated brick HLz according to EN 771-1 $\rho \geq 1,0$ [kg/dm ³] $f_b \geq 10$ [N/mm ²]			FIS H 12x85 K FIS H 16x85 K FIS H 20x85 K FIS H 20x130 K
Brick No. 8 Perforated brick HLz filled with mineral wool according to EN 771-1 $\rho \geq 0,6$ [kg/dm ³] $f_b \geq 8$ [N/mm ²]			FIS H 12x85 K FIS H 16x85 K FIS H 20x85 K FIS H 16x130 K FIS H 20x130 K FIS H 20x200 K
Brick-No. 9 Light-weight concrete hollow block Hbl according to EN 771-1 $\rho \geq 1,0$ [kg/dm ³] $f_b \geq 4$ [N/mm ²]			FIS H 12x85 K FIS H 16x85 K FIS H 20x85 K FIS H 16x130 K FIS H 20x130 K
Brick No. 10 Autoclaved aerated concrete block $\rho \geq 350, 500$ or 650 [kg/dm ³] $f_b \geq 2, 4$ or 6 [N/mm ²]			M8; M10; M12
			FIS E 11x85 M6 FIS E 11x85 M8 FIS E 15x85 M10 FIS E 15x85 M12

¹⁾ Other combinations can be used after job site tests acc. to ETAG 029, Annex B.

²⁾ Sleeve/anchor rod combination see table B1.3

The β - factor for this job site tests are given in Table C4

Imaging of the bricks are not scaled

fischer Injectionsystem FIS P Plus for masonry

Intended Use
 Allocation of threaded rods, perforated sleeves and bricks, part 2

Annex B 10

Table C1.1: Characteristic values of resistance under tension loads and under shear loads

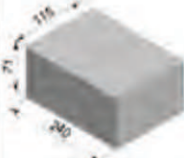
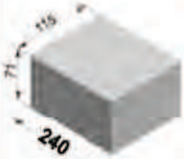
Brick	Density ρ [kg/dm ³] - Compressive strength f_b [N/mm ²]	Perforated sleeve FIS H...K	Anchor size or screw size in internal threaded anchor	Effective anchorage depth		Characteristic resistance [kN]			
				$h_{ef,min}$ [mm]	$h_{ef,max}$ [mm]	N_{Rk}		V_{Rk}	
						Temp. 50/80°C			
				d/d	w/w	All categories			
 <p>No.1 Solid brick Mz</p>	$\rho \geq 1,8$ $f_b \geq 10$	without	M8	50	200	4,0	2,5	2,5	
			M10	50	79	3,5	2,0		4,0
			M10	80	199	5,0	3,0		
			M10	200	200	8,5	7,5	8,5	
			M12	50	79	3,0	2,0	4,0	
			M12	80	199	5,5	3,5		
			M12	200	200	8,0	5,0	8,5	
	FIS E 11x85 M6/ M8		85	85	5,5	3,5	2,5		
	$\rho \geq 1,8$ $f_b \geq 20$		M8	50	200	5,5	3,5	4,0	
			M10	50	79	5,0	3,0	6,0	
			M10	80	199	7,0	4,5		
			M10	200	200	8,5	8,5	8,5	
			M12	50	79	4,5	3,0	5,5	
			M12	80	199	8,0	5,0		
M12		200	200	8,5	7,0	8,5			
FIS E 11x85 M6/ M8	85	85	8,0	5,0	4,0				
 <p>No.2 Solid sand-lime brick</p>	$\rho \geq 1,8$ $f_b \geq 10$	without	M8	50	200	2,5	1,5	4,0	
			M10	50	79				
			M10	80	199				
			M10	200	200	8,5	6,0		
			M12	50	79	2,5	1,5	5,0	
			M12	80	199				
			M12	200	200	8,5	6,5		
	FIS E 11x85 M6/ M8		85	85	2,5	1,5	3,0		
	$\rho \geq 1,8$ $f_b \geq 20$		M8	50	200	3,5	2,0	5,5	
			M10	50	79				
			M10	80	199				
			M10	200	200	8,5	8,5		
			M12	50	79	3,5	2,0	7,0	
			M12	80	199				
M12		200	200	8,5	8,5				
FIS E 11x85 M6/ M8	85	85	3,5	2,0	4,0				

Imaging of the bricks are not scaled

fischer Injectionsystem FIS P Plus for masonry

Performances
Characteristic values of resistance under tension loads and under shear loads, part 1

Annex C 1

Table C1.2: Characteristic values of resistance under tension loads and under shear loads

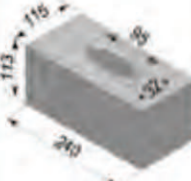
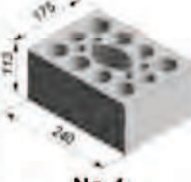
Brick	Density ρ [kg/dm ³] - Compressive strength f_b [N/mm ²]	Perforated sleeve FIS H...K	Anchor size or screw size in internal threaded anchor	Effective anchorage depth		Characteristic resistance [kN]		
				$h_{ef,min}$ [mm]	$h_{ef,max}$ [mm]	N _{Rk}		V _{Rk}
						Temp. 50/80°C		
				d/d	w/w	All categories		
 <p>No.3 Solid sand-lime brick</p>	$\rho \geq 1,8$ $f_b \geq 10$	12x85	M8	85	85	6,0	3,5	3,0
		16x85	FIS E 11x85 M6	85	85	3,5	2,0	
		16x85	M8/M10, FIS E 11x85 M8	85	85	3,5	2,0	3,5
		20x85	M12, FIS E 15x85 M10/M12	85	85	8,5	6,5	
		16x130	M8/M10	110	130	3,5	2,0	
		20x130	M12	110	130	7,0	4,5	
	$\rho \geq 1,8$ $f_b \geq 20$	12x85	M8	85	85	8,5	5,0	4,5
		16x85	FIS E 11x85 M6	85	85	5,5	3,0	
		16x85	M8/M10, FIS E 11x85 M8	85	85	5,5	3,0	5,5
		20x85	M12, FIS E 15x85 M10/M12	85	85	8,5	8,5	
		16x130	M8/M10	110	130	5,0	3,0	
		20x130	M12	110	130	8,5	6,0	
 <p>No.4 Sand-lime hollow brick</p>	$\rho \geq 1,4$ $f_b \geq 12$	12x85	M8	85	85	2,5	2,5	2,5
		16x85	FIS E 11x85 M6	85	85	3,0	2,5	
		16x85	M8/M10, FIS E 11x85 M8	85	85	3,0	2,5	4,5
		20x85	M12, FIS E 15x85 M10/M12	85	85	3,5	3,0	4,5
		16x130	M8/M10	110	130			
		20x130	M12	110	130			
	$\rho \geq 1,4$ $f_b \geq 20$	12x85	M8	85	85	4,5	4,0	4,5
		16x85	FIS E 11x85 M6	85	85	5,0	4,0	4,0
		16x85	M8/M10, FIS E 11x85 M8	85	85	5,0	4,5	7,5
		20x85	M12, FIS E 15x85 M10/M12	85	85	6,0	5,5	7,5
		16x130	M8/M10	110	130			
		20x130	M12	110	130			





Imaging of the bricks are not scaled

fischer Injectionsystem FIS P Plus for masonry

Performances
Characteristic values of resistance under tension loads and under shear loads, part 2

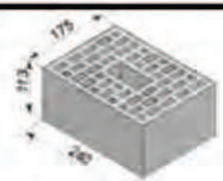
Annex C 2

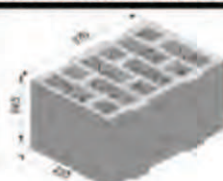
Table C1.3: Characteristic values of resistance under tension loads and under shear loads

Brick	Density ρ [kg/dm ³] - Compressive strength f_b [N/mm ²]	Perforated sleeve FIS H...K	Anchor size or screw size in internal threaded anchor	Effective anchorage depth		Characteristic resistance [kN]		
				$h_{ef,min}$ [mm]	$h_{ef,max}$ [mm]	N _{Rk}		V _{Rk}
						Temp. 50/80°C		All categories
						d/d	w/w	
 No.5 Perforated brick HLz	$\rho \geq 0,9$ $f_b \geq 10$	12x85	M8	85	85	4,0	3,5	4,0
		16x85	FIS E 11x85 M6	85	85	3,5	3,5	4,0
		16x85	M8/M10, FIS E 11x85 M8	85	85	3,5	3,5	5,5
		20x85	M12, FIS E 15x85 M10/M12	85	85	5,0	4,5	6,0
		16x130	M8/M10	130	130	5,0	4,5	5,5
		20x130	M12	110	130	5,0	4,5	6,0
 No.6 Perforated brick HLz	$\rho \geq 1,4$ $f_b \geq 20$	12x85	M8	85	85	4,0	3,5	7,5 (5,5) ¹⁾
		16x85	FIS E 11x85 M6	85	85	2,5		4,0
		16x85	M8/M10, FIS E 11x85 M8	85	85	2,5		4,5
		20x85	M12, FIS E 15x85 M10/M12	85	85	3,0		8,5 (5,5) ¹⁾
 No.7 Perforated brick HLz	$\rho \geq 1,0$ $f_b \geq 10$	12x85	M8	85	85	0,9		1,2
		16x85	M8/M10, FIS E 11x85 M6/M8	85	85	2,5		
		20x85	M12, FIS E 15x85 M10/M12	85	85	2,5		1,5
		16x130	M8/M10	110	130	2,5		
		20x130	M12	110	130	3,5	3,0	
 No.8 Perforated brick HLz	$\rho \geq 0,6$ $f_b \geq 8$	12x85	M8	85	85	2,0	2,0	2,5
		16x85	FIS E 11x85 M6	85	85	2,0	1,5	2,5
		16x85	M8/M10, FIS E 11x85 M8	85	85	2,0	1,5	3,0
		20x85	M12, FIS E 15x85 M10/M12	85	85	2,0	2,0	1,5
		16x130	M8/M10	130	130	3,0	2,5	3,0
		20x130	M12	110	130	2,0	2,0	1,5
		20x200	M12	180	200	3,0	3,0	1,5
 No.9 Light-weight concrete hollow block	$\rho \geq 1,0$ $f_b \geq 4$	12x85	M8	85	85	3,0		2,0
		16x85	M8/M10, FIS E 11x85 M6/M8	85	85	3,0		
		20x85	M12, FIS E 15x85 M10/M12	85	85	3,0		
		16x130	M8/M10	130	130	3,0		
		20x130	M12	110	130	3,0		

¹⁾ Characteristic value of pushing out of one brick $V_{Rk,pb} = 5,5$ kN
Imaging of the bricks are not scaled

fischer Injectionsystem FIS P Plus for masonry

Performances
Characteristic values of resistance under tension loads and under shear loads, part 3

Annex C 3

Table C1.4: Characteristic values of resistance under tension loads and under shear loads

Brick	Density ρ [kg/dm ³] - Compressive strength f_b [N/mm ²]	Perforated sleeve FIS H...K	Anchor size or screw size in internal threaded anchor	Effective anchorage depth		Characteristic resistance [kN]			
				$h_{ef,min}$ [mm]	$h_{ef,max}$ [mm]	N _{RK}		V _{RK}	
						Temp. 50/80°C			
						d/d	w/w		
							All categories		
 <p>No.10 Aerated concrete block</p>	$\rho \geq 350$ $f_b \geq 2$	ohne	M8	100	120	1,5		1,2	
			M10	100	120			1,2	
			M12	100	120			1,5	
			FIS E 11x85 M6/M8 FIS E 15x85 M10/M12	85				1,2	
	$\rho \geq 500$ $f_b \geq 4$	ohne	M8	100	120	2,0	2,5	2,5	
			M10	100	120	2,0			
			M12	100	120	2,5			
			FIS E 11x85 M6/M8 FIS E 15x85 M10/M12	85		2,0	2,0		
	$\rho \geq 650$ $f_b \geq 6$	ohne	M8	100	120	3,5	5,0	4,5	3,0
			M10	100	120	3,0			
			M12	100	120	3,5			
			FIS E 11x85 M6/M8 FIS E 15x85 M10/M12	85		3,5	2,5		

Imaging of the bricks are not scaled

fischer Injectionsystem FIS P Plus for masonry

Performances

Characteristic values of resistance under tension loads and under shear loads, part 4

Annex C 4

Table C2: Characteristic bending moments

Size				M8	M10	M12
Characteristic bending moment $M_{Rk,s}$	Zinc-plated steel	Property class	5.8 [Nm]	19	37	65
			8.8 [Nm]	30	60	105
	Stainless steel A4	Property class	50 [Nm]	19	37	65
			70 [Nm]	26	52	92
			80 [Nm]	30	60	105
	High corrosion-resistant steel C	Property class	50 [Nm]	19	37	65
			70 ¹⁾ [Nm]	26	52	92
			80 [Nm]	30	60	105

¹⁾ $f_{uk}= 700 \text{ N/mm}^2$; $f_{yk}=560 \text{ N/mm}^2$

Table C2.1: Characteristic bending moments for internal threaded anchors FIS E

Size FIS E				M6	M8	M10	M12
Characteristic bending moments $M_{Rk,s}$	zinc plated steel,	Property class of screw	5.8 [Nm]	8	19	37	65
			8.8 [Nm]	12	30	60	105
	stainless steel A4	Property class of screw	70 [Nm]	11	26	52	92
			high corrosion resistant steel C	Property class of screw	70 [Nm]	11	26

Tabelle C3: Displacements under tension loads and shear loads

Material	N [kN]	δN_0 [mm]	δN_∞ [mm]	V [kN]	δV_0 [mm]	δV_∞ [mm]
solid units and autoclaved aerated concrete	$\frac{N_{RK}}{1,4 * \gamma_M}$	0,03	0,06	$\frac{V_{RK}}{1,4 * \gamma_M}$	0,59	0,88
	$\frac{N_{RK}}{1,4 * \gamma_M}$	0,03	0,06	$\frac{V_{RK}}{1,4 * \gamma_M}$	1,71	2,56

fischer Injectionsystem FIS P Plus for masonry

Performances
Characteristic bending moments; displacements

Annex C 5

Table C4: β - factor for job site tests according to ETAG 029, Annex B

Using categories		w/w	d/d
Temperature range [°C]		50/80	50/80
Brick	Size ¹⁾		
Solid brick	M8	0,57	0,96
	M10	0,59	
	M12 FIS E 11x85 M6 / M8 FIS E 15x85 M10 / M12	0,60	
Hollow brick	All sizes	0,86	0,96
Autoclaved aerated concrete	All size	0,73	0,81

fischer Injectionsystem FIS P Plus for masonry

Performances
 β - factors for job site tests

Annex C 6

Table C5: Edge distance and spacing (installation with and without sleeves)

Direction to bed joint		⊥				Group factor				Min. thickness of the masonry members [mm]
Brick No.	h _{ef} [mm]	c _{cr} = c _{min}	s _{min}	s _{cr}	s _{min}	s _{cr}	⊥			
		[mm]	[mm]	[mm]	[mm]	[mm]	α _{g,N}	α _{g,V}	α _{g,N}	α _{g,V}
1	50	100	75	60 ¹⁾	150	2	2	1,5	1,4	h _{ef} + 30 (≥ 80)
	80	100	75	60 ¹⁾	240	2	2	1,5	1,4	
	200	150	75	240		2				
2	50	100	75	240		2				
	80	100	75	240		2				
	200	150	75	240		2				
3	85	100	115	240		2				
	130	100	115	240		2				
4	all sizes	100	115	100	240	2	2	1,5	1,5	
5	all sizes	100	115	240		2				
6	all sizes	100	115	240		2				
7	all sizes	100	100	240	100	375 (500) ²⁾	1	1	1	1
8	all sizes	120	245		250		2			
9	all sizes	80	240		365		2			
10	all sizes	100	250		300		2			

¹⁾ only valid for tension loads, for shear loads s_{min} || = s_{cr} ||

²⁾ spacing for alternative brick dimension, see table B4, brick 7

fischer Injectionsystem FIS P Plus for masonry

Performances
Edge distance and spacing

Annex C 7

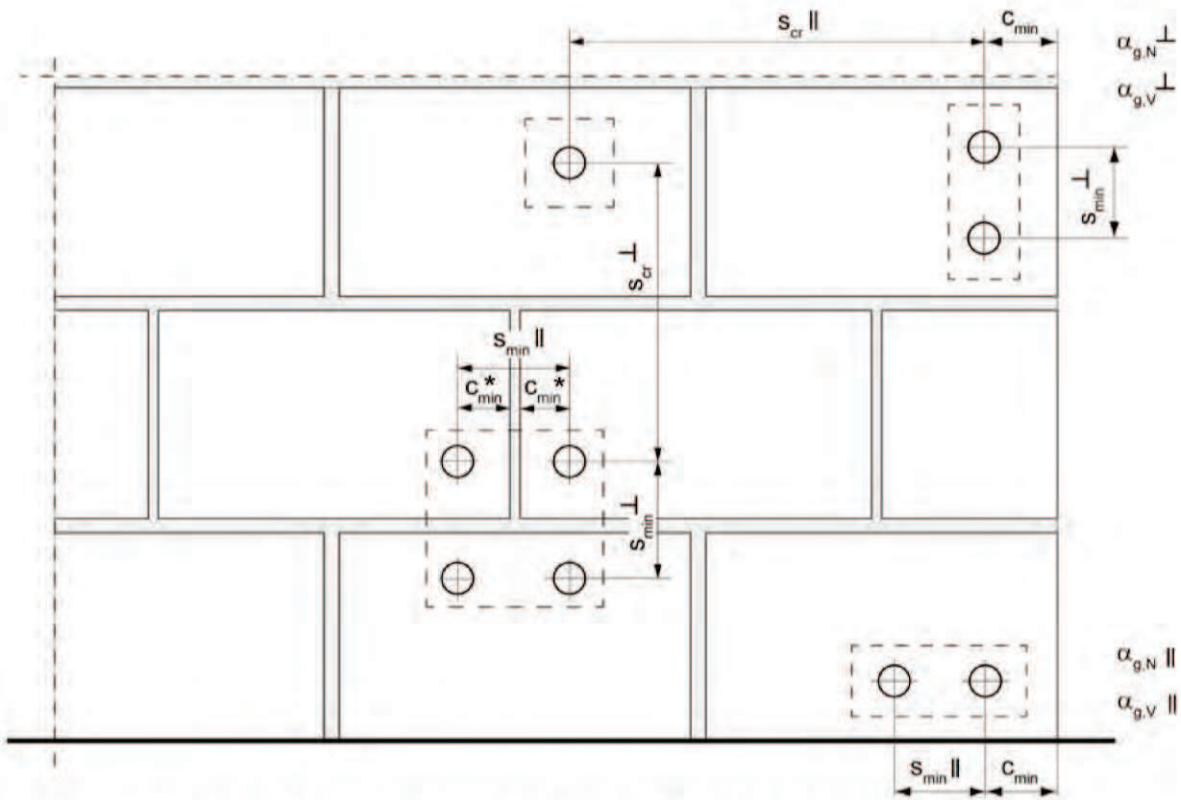

* Only, if joints are visible and/or vertical joints are not filled with mortar

- $s_{min ||}$ = Minimum spacing parallel to bed joint
- $s_{min \perp}$ = Minimum spacing vertical to bed joint
- $s_{cr ||}$ = Characteristic spacing parallel to bed joint
- $s_{cr \perp}$ = Characteristic spacing vertical to bed joint
- $c_{cr} = c_{min}$ = Edge distance
- $\alpha_{g,N ||}$ = Group factor for tension load parallel to bed joint
- $\alpha_{g,V ||}$ = Group factor for shear load parallel to bed joint
- $\alpha_{g,N \perp}$ = Group factor for tension load vertical to bed joint
- $\alpha_{g,V \perp}$ = Group factor for shear load vertical to bed joint

For $s > s_{cr}$ $\alpha_g = 2$

For $s_{min} \leq s \leq s_{cr}$ α_g according to table C5

$N_{Rk}^g = \alpha_{g,N} \cdot N_{Rk}$; $V_{Rk}^g = \alpha_{g,V} \cdot V_{Rk}$ (Group of 2 anchors)

$N_{Rk}^g = \alpha_{g,N ||} \cdot \alpha_{g,N \perp} \cdot N_{Rk}$; $V_{Rk}^g = \alpha_{g,V ||} \cdot \alpha_{g,V \perp} \cdot V_{Rk}$ (Group of 4 anchors)

fischer Injectionsystem FIS P Plus for masonry

Performance

Definition of minimum edge distance, minimum spacing and group factors

Annex C 8