

DECLARACIÓN DE PRESTACIONES

DoP 0313

para el anclaje- perno fischer FAZ II Plus, FAZ II Plus R, FAZ II Plus HCR (anclaje mecánico para uso en hormigón)

ES

1. Código de identificación única del producto tipo: **DoP 0313**
2. Usos previstos: **Fijación a posteriori en hormigón fisurado y no fisurado, véase el apéndice, especialmente los anexos B1 - B4.**
3. Fabricante: **fischerwerke GmbH & Co. KG, Klaus-Fischer-Str. 1, 72178 Waldachtal, Alemania**
4. Representante autorizado: **-**
5. Sistemas de evaluación y verificación de la constancia de las prestaciones (EVCP): **1**
6. Documento de evaluación europeo: **EAD 330232-01-0601, Edition 05/2021**
Evaluación técnica europea: **ETA-19/0520; 2022-02-21**
Organismo de evaluación técnica: **DIBt- Deutsches Institut für Bautechnik**
Organismos notificados: **2873 TU Darmstadt**
7. Prestaciones declaradas:
Resistencia mecánica y estabilidad (BWR 1)
Resistencia característica a tracción (carga estática y cuasi-estática) Método A:
Resistencia de rotura del acero: Anexo C1
Résistance à la rupture par extraction glissement: Anexo C1
Resistencia de rotura por cono de hormigón: Anexo C1
Robustez: Anexo C1
Distancia mínima entre el borde y el centro: Anexos C5, C6
Distancia al borde para evitar la rotura del acero sometido a carga: Anexo C1

Resistencia característica a cortante (carga estática y cuasi-estática), Method A:
Resistencia de rotura del acero (esfuerzo cortante): Anexo C2
Resistencia falla por arrancamiento lateral: Anexo C2

Resistencia característica para diseño simplificado:
Método B: NPD
Método C: NPD

Desplazamientos:
Desplazamiento por carga estática y cuasi-estática: Anexo C9

Resistencia y desplazamientos característicos para las categorías sísmicas C1 y C2:
Resistencia a carga de tracción, desplazamientos, categoría C1: Anexo C7
Resistencia a carga de tracción, desplazamientos, categoría C2: Anexos C8, C9
Resistencia a esfuerzo cortante, desplazamientos, categoría C1: Anexo C7
Resistencia a esfuerzo cortante, desplazamientos, categoría C2: Anexos C8, C9
Factor espacio anular: Anexos C7, C8

Seguridad en caso de incendio (BWR 2)
Reacción al fuego: Clase (A1)
Resistencia al fuego:
Resistencia al fuego, rotura del acero (carga de tracción): Anexo C3
Resistencia al fuego, a la extracción (carga de tracción): Anexo C3
Resistencia al fuego, rotura del acero (esfuerzo cortante): Anexos C3, C4

Durabilidad:
Durabilidad: Anexos A4, B1
8. Documentación técnica adecuada o documentación técnica específica: **-**



Las prestaciones del producto identificado anteriormente son conformes con el conjunto de prestaciones declaradas. La presente declaración de prestaciones se emite, de conformidad con el Reglamento (UE) no 305/2011, bajo la sola responsabilidad del fabricante arriba identificado.

Firmado por y en nombre del fabricante por:

Dr.-Ing. Oliver Geibig, Director General Unidades de Negocio e Ingeniería
Tumlingen, 2023-01-31

Jürgen Grün, Director General de Química y Calidad

Esta DdR se ha preparado en distintos idiomas. En caso de que haya alguna controversia sobre la interpretación prevalecerá siempre la versión inglesa.

El Apéndice incluye información voluntaria y complementaria en idioma inglés que excede los requisitos legales (de idioma neutral).

Specific Part

1 Technical description of the product

The Fischer Bolt Anchor FAZ II Plus, FAZ II Plus R, FAZ II Plus HCR is an anchor made of galvanized steel (FAZ II Plus), stainless steel (FAZ II Plus R) or high corrosion resistant steel (FAZ II Plus HCR) which is placed into a drilled hole and anchored by torque-controlled expansion.

The product description is given in Annex A.

2 Specification of the intended use in accordance with the applicable European Assessment Document

The performances given in Section 3 are only valid if the anchor is used in compliance with the specifications and conditions given in Annex B.

The verifications and assessment methods on which this European Technical Assessment is based lead to the assumption of a working life of the anchor of at least 50 years. The indications given on the working life cannot be interpreted as a guarantee given by the producer, but are to be regarded only as a means for choosing the right products in relation to the expected economically reasonable working life of the works.

3 Performance of the product and references to the methods used for its assessment

3.1 Mechanical resistance and stability (BWR 1)

Essential characteristic	Performance
Characteristic resistance to tension load (static and quasi-static loading), Method A	See Annex C1, C5 and C6
Characteristic resistance to shear load (static and quasi-static loading)	See Annex C2
Displacements and Durability	See Annex C9 and B1
Characteristic resistance and displacements for seismic performance categories C1 and C2	See Annex C7 to C9

3.2 Safety in case of fire (BWR 2)

Essential characteristic	Performance
Reaction to fire	Class A1
Resistance to fire	See Annex C3 and C4

4 Assessment and verification of constancy of performance (AVCP) system applied, with reference to its legal base

In accordance with the European Assessment Document EAD 330232-01-0601 the applicable European legal act is: [96/582/EC].

The system to be applied is: 1

Cone bolt manufactured by cold - forming:

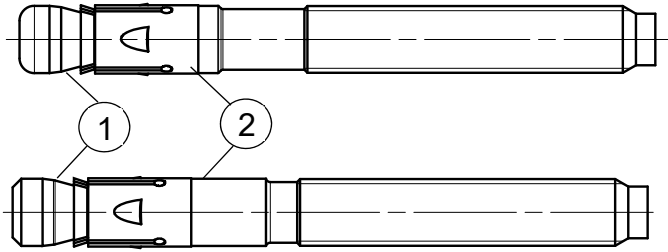

Cone bolt manufactured by turning:

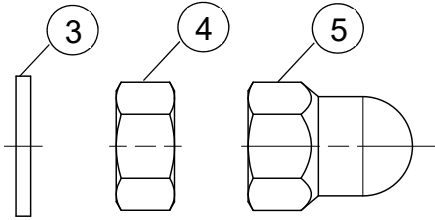

- ① Expansion sleeve
- ② Cone bolt (cold – formed or turned)
- ③ Washer
- ④ Hexagon nut
- ⑤ fischer FAZ II Plus dome nut

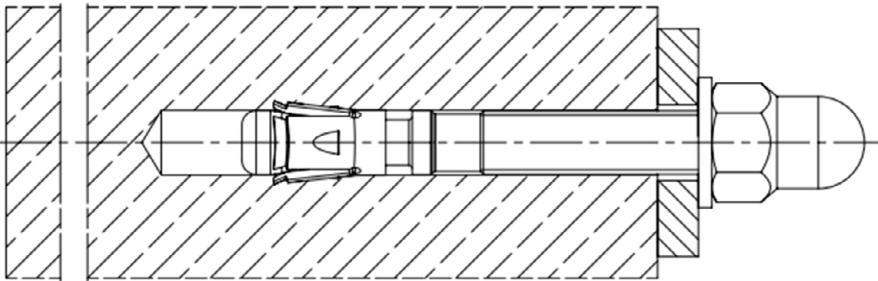
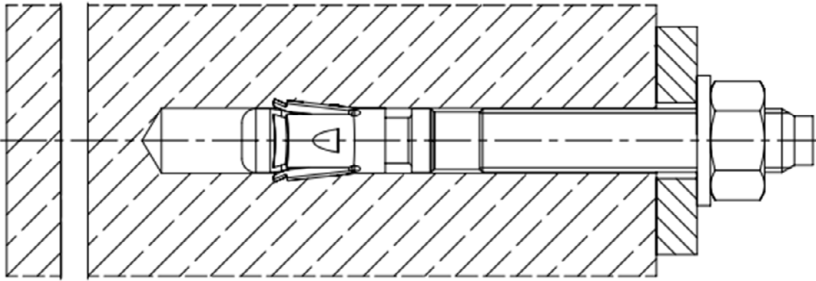

(Figure not to scale)

fischer Bolt Anchor FAZ II Plus, FAZ II Plus R, FAZ II Plus HCR

Product description
Installed condition

Annex A1

Appendix 3 / 19

Product marking and letter-code:

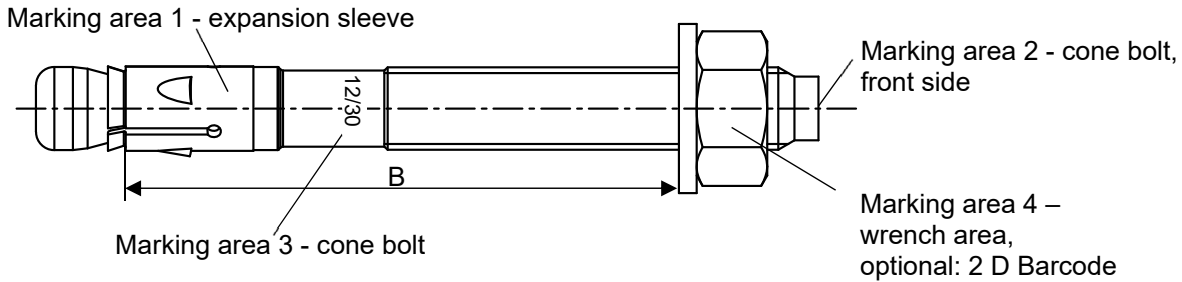

Product marking, example:

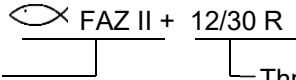

Brand | type of fastener
placed at marking area 1 or 3

Thread size / max. thickness of the fixture (t_{fix})
identification R or HCR placed at marking area 1 or 3

FAZ II Plus: carbon steel, galvanised
FAZ II Plus R: stainless steel
FAZ II Plus HCR: high corrosion resistant steel

Table A2.1: Letter - code at marking area 2:

Marking	(a)	(b)	(c)	(d)	(A)	(B)	(C)	(D)	(E)	(F)	(G)	(H)	(I)	(K)	
Max. t_{fix} [mm]	5	10	15	20	5	10	15	20	25	30	35	40	45	50	
$B \geq$ [mm]	M6	-			45	50	55	60	65	70	75	80	85	90	
	M8	40	45	-	50	55	60	65	70	75	80	85	90	95	
	M10	45	50	55	60	65	70	75	80	85	90	95	100	105	110
	M12	55	60	65	70	75	80	85	90	95	100	105	110	115	120
	M16	70	75	80	85	90	95	100	105	110	115	120	125	130	135
	M20	-			105	110	115	120	125	130	135	140	145	150	
	M24	-			130	135	140	145	150	155	160	165	170	175	

Marking	(L)	(M)	(N)	(O)	(P)	(R)	(S)	(T)	(U)	(V)	(W)	(X)	(Y)	(Z)	
Max. t_{fix} [mm]	60	70	80	90	100	120	140	160	180	200	250	300	350	400	
$B \geq$ [mm]	M6	100	110	120	130	140	160	180	200	220	240	290	340	390	440
	M8	105	115	125	135	145	165	185	205	225	245	295	345	395	445
	M10	120	130	140	150	160	180	200	220	240	260	310	360	410	460
	M12	130	140	150	160	170	190	210	230	250	270	320	370	420	470
	M16	145	155	165	175	185	205	225	245	265	285	335	385	435	485
	M20	160	170	180	190	200	220	240	260	280	300	350	400	450	500
	M24	185	195	205	215	225	245	265	285	305	325	375	425	475	525

Calculation existing h_{ef} for installed fasteners:

$$\text{existing } h_{ef} = B_{(\text{according to table A2.1})} - \text{existing } t_{fix}$$

Thickness of the fixture t_{fix} including thickness of filling conical washer t and e.g. thickness of grout layer t_{grout} or other non-structural layers

(Figure not to scale)

fischer Bolt Anchor FAZ II Plus, FAZ II Plus R, FAZ II Plus HCR

Product description
Product marking and letter code

Annex A2

Appendix 4 / 19

Product dimensions

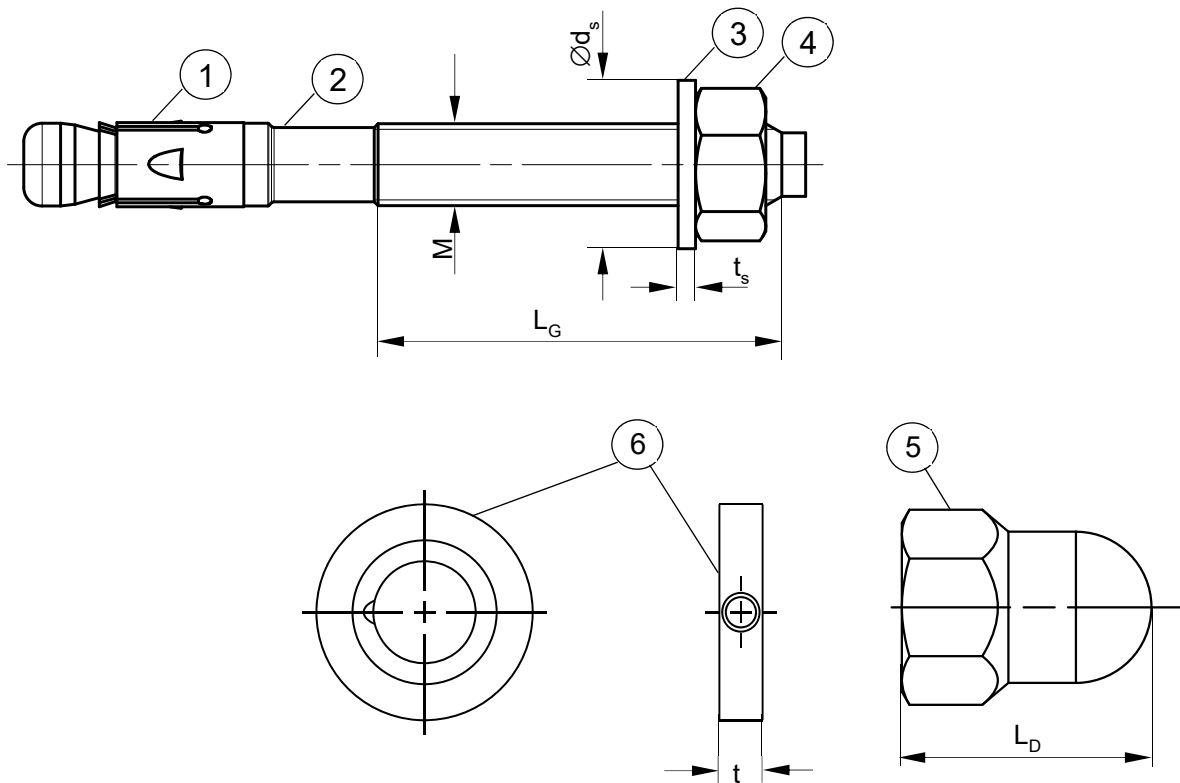

Table A3.1: Dimensions [mm]

Part	Designation		FAZ II Plus, FAZ II Plus R, FAZ II Plus HCR						
			M6	M8	M10	M12	M16	M20	M24
1	Expansion sleeve	Sheet thickness	0,8	1,3	1,4	1,6	2,4		3,0
2	Cone bolt	Thread size M	6	8	10	12	16	20	24
		L_G	10	19	26	31	40	50	57
3	Washer	t_s	$\geq 1,4$		1,8	2,3	$\geq 2,7$		3,7
		$\varnothing d_s$	11	15	19	23	29	36	43
4 & 5	Hexagon nut / fischer FAZ II Plus dome nut	Wrench size ¹⁾	10	13	17	19	24	30	36
5	fischer filling conical washer FFD	L_D	$\geq -^2)$		22	27	33	$\geq -^2)$	
6	fischer filling conical washer FFD	t	$= 6$				7	8	10

¹⁾ Alternatively according to ISO 4032:2013 allowed

²⁾ Not part of the assessment

(Figure not to scale)

fischer Bolt Anchor FAZ II Plus, FAZ II Plus R, FAZ II Plus HCR

Product description
Dimensions

Annex A3

Appendix 5 / 19

Table A4.1: Materials FAZ II Plus

Part	Designation	Material		
		FAZ II Plus	FAZ II Plus R	FAZ II Plus HCR
	Steel grade	Steel	Stainless steel R EN 10088:2014	High corrosion resistant steel HCR EN 10088:2014
		Zinc plated $\geq 5 \mu\text{m}$, ISO 4042:2018	Corrosion resistance class CRC III in accordance with EN 1993-1-4:2006+A1:2015	Corrosion resistance class CRC V in accordance with EN 1993-1-4:2006+A1:2015
1	Expansion sleeve	Cold strip, EN 10139:2016 or stainless steel EN 10088:2014	Stainless steel EN 10088:2014	
2	Cone bolt	Cold form steel or free cutting steel	Stainless steel EN 10088:2014	High corrosion resistant steel EN 10088:2014
3	Washer	Cold strip, EN 10139:2016		
4 / 5	Hexagon nut / fischer FAZ II Plus dome nut	Steel, property class min. 8, EN ISO 898-2:2012	Stainless steel EN 10088:2014; ISO 3506-2:2020; property class – min. 70	High corrosion resistant steel EN 10088:2014; ISO 3506-2:2020; property class – min. 70
6	fischer filling conical washer FFD	Cold form steel or free cutting steel	Stainless steel EN 10088:2014	High corrosion resistant steel EN 10088:2014



fischer Bolt Anchor FAZ II Plus, FAZ II Plus R, FAZ II Plus HCR

Product description
Materials

Annex A4
Appendix 6 / 19

Specifications of intended use

Fastenings subject to:

Size	FAZ II Plus, FAZ II Plus R, FAZ II Plus HCR						
	M6	M8	M10	M12	M16	M20	M24
Hammer drilling with standard drill bit 				✓			
Hammer drilling with hollow drill bit with automatic cleaning 	- ¹⁾			✓			
Diamond drilling 	- ¹⁾	✓	(for non seismic applications only)				
Static and quasi-static loads				✓			
Cracked and uncracked concrete				✓			
Fire exposure							
Seismic performance category C1	- ¹⁾			✓			
Seismic performance category C2		- ¹⁾			✓		

¹⁾ No performance assessed

Base materials:

- Compacted reinforced and unreinforced normal weight concrete without fibres (cracked or uncracked) according to EN 206-1:2013+A2:2021
- Strength classes C20/25 to C50/60 according to EN 206:2013+A2:2021

Use conditions (Environmental conditions):

- Structures subject to dry internal conditions (FAZ II Plus, FAZ II Plus R, FAZ II Plus HCR)
- For all other conditions according to EN 1993-1-4:2006 + A1:2015 corresponding to corrosion resistance class
 - CRC III: for FAZ II Plus R
 - CRC V: for FAZ II Plus HCR

Design:

- Fastenings are to be designed under the responsibility of an engineer experienced in fastenings and concrete work
- Verifiable calculation notes and drawings are to be prepared taking account of the loads to be anchored. The position of the fastener is indicated on the design drawings (e.g. position of the fastener relative to reinforcement or to supports, etc.)
- Fastenings in stand-off installation or with a grout layer under seismic action are not covered
- In case of seismic applications the fastener shall be positioned outside of critical regions (e.g. plastic hinges) of the concrete structure
- Design of fastenings according to EN 1992-4:2018 and EOTA Technical Report TR 055:2018

fischer Bolt Anchor FAZ II Plus, FAZ II Plus R, FAZ II Plus HCR

Intended Use
Specifications

Annex B1

Appendix 7 / 19

Table B2.1: Installation parameters

Size	FAZ II Plus, FAZ II Plus R, FAZ II Plus HCR						
	M6	M8	M10	M12	M16	M20	M24
Nominal drill hole diameter $d_0 =$	6	8	10	12	16	20	24
Maximum bit diameter with hammer or hollow drilling $d_{cut,max}$ [mm]	6,40	8,45	10,45	12,5	16,5	20,55	24,55
Maximum bit diameter with diamond drilling	- ¹⁾	8,15		12,25	16,45	20,50	24,40
Effective embedment depth $h_{ef} \geq$	40-80	35-90	40-100	50-125	65-160	100-180	125
Length from h_{ef} to end of cone bolt L	6,5	9,5	11,5	13,5	17,5	20,0	23,5
Overall fastener embedment depth in the concrete $h_{nom} \geq$ [mm]	$h_{ef} + L$						
Depth of drill hole to deepest point $h_1 \geq$	$h_{nom} + 3$			$h_{nom} + 5$		$h_{nom} + 10$	
Diameter of clearance hole in the fixture $d_f \leq$ [mm]	7	9	12	14	18	22	26
Required setting torque $T_{inst} =$ [Nm]	8	20	45	60	110	200	270
Excess length after hammering-in the cone bolt (for fischer dome nut applications according to Annex B4) $O =$ [mm]	- ¹⁾		12	16	20	- ¹⁾	

¹⁾ Not part of the assessment

Setting gauge FAZ II Plus SL-H for fastener with fischer FAZ II Plus dome nut:

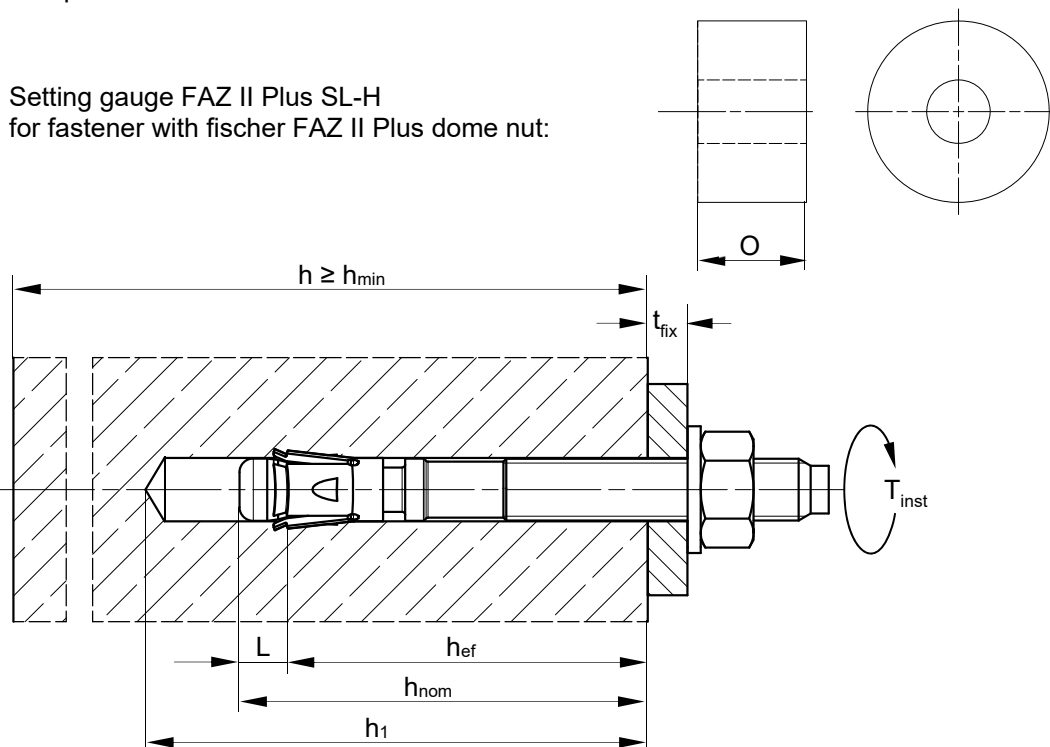

- h_{ef} = Effective embedment depth
- t_{fix} = Thickness of the fixture
- h_1 = Depth of drill hole to deepest point
- h = Thickness of the concrete member
- h_{min} = Minimum thickness of concrete member
- h_{nom} = Overall fastener embedment depth in the concrete

- O = Length of setting gauge
- L = Length from h_{ef} to end of cone bolt
- T_{inst} = Required setting torque

fischer Bolt Anchor FAZ II Plus, FAZ II Plus R, FAZ II Plus HCR

Intended Use
Installation parameters





Annex B2
Appendix 8 / 19

Installation instructions:

- Fastener installation carried out by appropriately qualified personnel according to the design drawings and under the supervision of the person responsible for technical matters on the site
- Use of the fastener only as supplied by the manufacturer without exchanging the components of the fastener
Exception: fischer FAZ II Plus dome nut
- Hammer, hollow or diamond drilling according to Annex B1 + B2
- Drill hole created perpendicular +/- 5° to concrete surface, positioning without damaging the reinforcement
- In case of aborted hole: new drilling at a minimum distance twice the depth of the aborted drill hole or smaller distance if the aborted drill hole is filled with high strength mortar and if under shear or oblique tension load it is not in the direction of load application

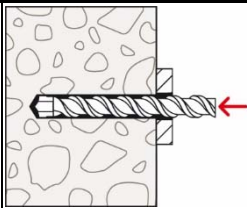
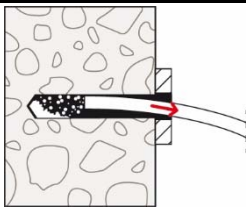
Installation instructions: Drilling and cleaning the hole

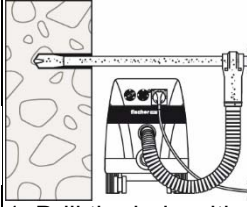
Types of drills and cleaning

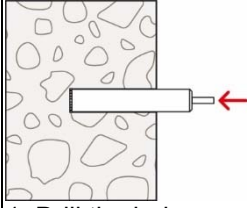
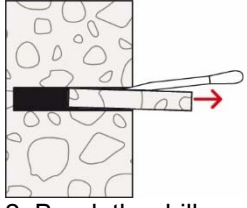
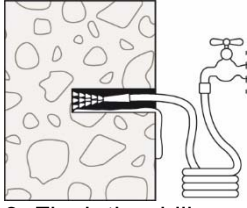
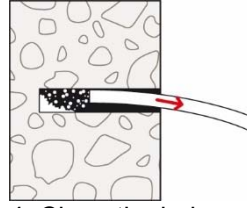
<p>Hammer drill (e.g. fischer Quattric II)</p>		 <p>1: Drill the hole</p>	 <p>2: Clean the hole</p> <p>Continue with step 5</p>
<p>Hollow drill (e.g. fischer FHD)</p>		 <p>1: Drill the hole with automatic cleaning (e.g. fischer FVC)</p>	 <p>Cleaning obsolete</p> <p>Continue with step 5</p>
<p>Diamond drill, for non seismic applications only</p>		 <p>1: Drill the hole</p>	 <p>2: Break the drill core and remove it</p>  <p>3: Flush the drill hole, until clear water emerges from the drill hole</p>  <p>4: Clean the hole</p>

fischer Bolt Anchor FAZ II Plus, FAZ II Plus R, FAZ II Plus HCR

Intended Use
Installation instructions

Annex B3

Appendix 9 / 19

Installation instructions: Installation of the fastener

HEXAGON NUT:

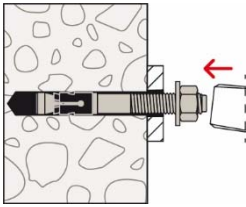

5.a: Set the fastener
e.g. with hammer

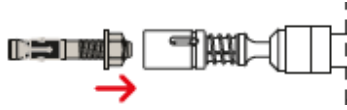

5.b: Set the fastener
e.g. fischer FA-ST II

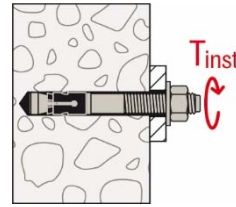

6: Apply T_{inst}

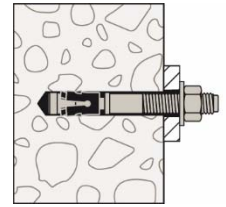

7: Installed fastener

fischer FAZ II Plus DOME NUT:

Option 1: Push through installation with setting gauge SL-H:

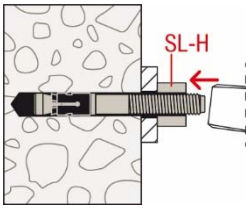

5.1: Set the fastener
through the set-
ting gauge and
fixture

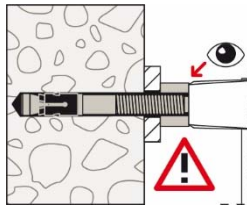

5.2: Check offset

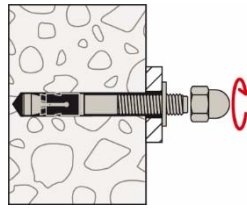

5.3: Turn on the
fischer FAZ II
Plus dome nut

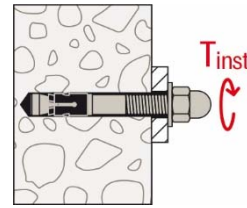

6: Apply T_{inst}

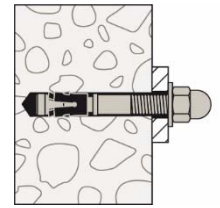

7: Installed fastener

Option 2: Push through installation with hexagon nut:

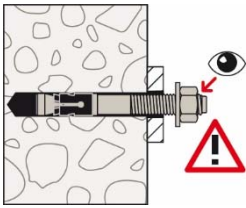

5.1: Check setting
position: Visible
one turn of a
thread

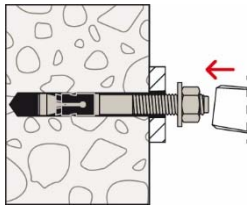

5.2: Set the fastener

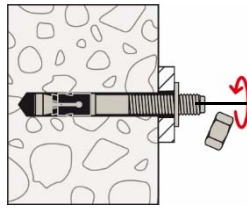

5.3: Remove nut

fischer Filling conical washer FFD optional for seismic C2 application or minimising the annular gap:

Optional

The gap between bolt and fixture may be filled with mortar (compressive strength $\geq 50 \text{ N/mm}^2$ e.g. fischer FIS SB) after last step (for eliminating the annular gap). The FFD is additional to the standard washer. The thickness of the FFD must be considered for definition of t_{fix} . Countersunk of the FFD in direction to the anchor plate. Installation with hexagon nut or dome nut is permitted.

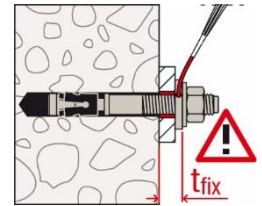
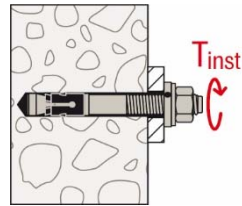
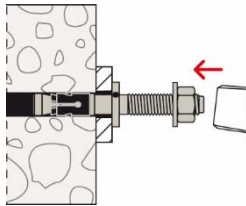
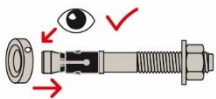

fischer Bolt Anchor FAZ II Plus, FAZ II Plus R, FAZ II Plus HCR

Intended Use
Installation instructions

Annex B4
Appendix 10 / 19

Table C1.1: Characteristic values of tension resistance under static and quasi-static action

Size		FAZ II Plus, FAZ II Plus R, FAZ II Plus HCR								
		M6	M8	M10	M12	M16	M20	M24		
Steel failure										
Characteristic resistance	FAZ II Plus	$N_{Rk,s}$ [kN]	11,3	19,9	32,7	49,3	78,7	108,4	180,0	
	FAZ II Plus R		12,1	21,0	34,5	52,0	83,0	127,6	187,0	
	FAZ II Plus HCR		11,3	17,6	29,1	43,8	69,9			
Partial factor for steel failure	FAZ II Plus	$\gamma_{Ms}^{1)}$ [-]	1,4					1,4	1,5	
	FAZ II Plus R		1,4					1,45		
	FAZ II Plus HCR		1,5	1,45		1,4	1,5			
Pullout failure										
Effective embedment depth for calculation	h_{ef} [mm]		40-80	40 ³⁾ - < 45	45-90	40-100	50-125	65-160	100-180	125
Characteristic resistance in cracked concrete C20/25	$N_{Rk,p}$ (C20/25) [kN]		1,5	5,5	8	13	20	27,0	34,4	48,1
Characteristic resistance in uncracked concrete C20/25			10,5	14		20	22	38,6	49,2	68,8
Increasing factor ψ_c for cracked or uncracked concrete $N_{Rk,p} = \psi_c \cdot N_{Rk,p}$ (C20/25)	[-]	C25/30				1,12				
		C30/37				1,22				
		C35/45				1,32				
		C40/50				1,41				
		C45/55				1,50				
C50/60				1,58						
Installation sensitivity factor	γ_{inst} [-]					1,0				
Concrete cone and splitting failure										
Factor for uncracked concrete	$k_{ucr,N}$ [-]					11,0 ²⁾				
Factor for cracked concrete	$k_{cr,N}$ [-]					7,7 ²⁾				
Characteristic spacing	$s_{cr,N}$ [mm]					3 · h_{ef}				
Characteristic edge distance	$c_{cr,N}$ [mm]					1,5 · h_{ef}				
Characteristic spacing for splitting failure	$s_{cr,sp}$ [mm]					2 · $c_{cr,sp}$				
Characteristic edge distance for splitting failure h	≥ 80	$c_{cr,sp}$ [mm]	40	2,4 · h_{ef}	2 · h_{ef}					
	≥ 100			2 · h_{ef}	2,4 · h_{ef}	2 · h_{ef}				
	≥ 120				1,9 · h_{ef}	2,1 · h_{ef}				
	≥ 140			1,5 · h_{ef}		2 · h_{ef}				
	≥ 160					2,4 · h_{ef}				
≥ 200						2,2 · h_{ef}				
Characteristic resistance to splitting	$N^0_{Rk,sp}$ [kN]		min { $N^0_{Rk,c}$; $N_{Rk,p}$ } ⁴⁾							

¹⁾ In absence of other national regulations

²⁾ Based on concrete strength as cylinder strength

³⁾ For dry internal exposure and statically indeterminate redundant components, the minimum effective embedment depth can be reduced to 35 mm without reduction of $N_{Rk,p}$.

⁴⁾ $N^0_{Rk,c}$ according to EN 1992-4:2018

⁵⁾ No performance assessed

fischer Bolt Anchor FAZ II Plus, FAZ II Plus R, FAZ II Plus HCR

Performances

Characteristic values of tension resistance under static and quasi-static action

Annex C1

Appendix 11 / 19

Table C2.1: Characteristic values of shear resistance under static and quasi-static action

Size		FAZ II Plus, FAZ II Plus R, FAZ II Plus HCR						
		M6	M8	M10	M12	M16	M20	M24
Steel failure without lever arm								
Characteristic resistance	FAZ II Plus without filling of the annular gap	7,5	16,3	26,2	37,0	68,4	82,9	128,3
	FAZ II Plus with filling		18,1	27,3	40,7	69,8	85,6	
	FAZ II Plus without filling R	8,8	17,6	26,5	42,1	71,1	107,9	158,1
	FAZ II Plus with filling R			27,6	44,3	73,6	117,9	
	FAZ II Plus without filling HCR		17,4	23,7	42,1	71,1	107,9	
	FAZ II Plus with filling HCR			27,9		73,6	117,9	
Partial factor for steel failure	$\gamma_{Ms}^{1)}$	1,25						
Factor for ductility	k_7	1,0						
Steel failure with lever arm and Concrete pryout failure								
Effective embedment depth for calculation	h_{ef} [mm]	40-80	45-90	60-100	70-125	85-160	100-180	125
Characteristic bending resistance	FAZ II Plus	11	30	60	105	266	422	864
	FAZ II Plus R		29	59	100	256	519	898
	FAZ II Plus HCR							
Factor for pryout failure	k_8 [-]	2,6	2,8	3,2				
Effective embedment depth for calculation	h_{ef} [mm]	- ²⁾	40 ³⁾ - < 45	40 - < 60	50 - < 70	65 - < 85	- ²⁾	
Characteristic bending resistance	FAZ II Plus		27	56	105	251		
	FAZ II Plus R		29	59	100	256		
	FAZ II Plus HCR		24	50		223		
Factor for pryout failure	k_8 [-]	2,5	2,6	3,1	3,2			
Partial factor for steel failure	$\gamma_{Ms}^{1)}$	1,25						
Factor for ductility	k_7	1,0						
Concrete edge failure								
Effective embedment depth for calculation	l_f [mm]	h_{ef}						
Outside diameter of a fastener	d_{nom}	6	8	10	12	16	20	24
¹⁾ In absence of other national regulations ²⁾ No performance assessed ³⁾ For dry internal exposure and statically indeterminate redundant components, the minimum effective embedment depth can be reduced to 35 mm without reduction of $N_{Rk,p}$.								
fischer Bolt Anchor FAZ II Plus, FAZ II Plus R, FAZ II Plus HCR							Annex C2 Appendix 12 / 19	
Performances Characteristic values of shear resistance under static and quasi-static action								

Table C3.1: Characteristic values of tension resistance under fire exposure

Size				FAZ II Plus, FAZ II Plus R, FAZ II Plus HCR										
				M6		M8		M10		M12		M16		M20
$h_{ef} \geq$ [mm]				40	35	45	40	60	50	70	65	85	100	125
Characteristic resistance steel failure	FAZ II Plus	$N_{Rk,s,fi}$	R30	0,6 ¹⁾ / 0,9 ²⁾		1,4	2,8	5,0	9,4	14,7	21,1			
			R60	0,4 ¹⁾ / 0,9 ²⁾		1,2	2,3	4,1	7,7	12,0	17,3			
			R90	0,3 ¹⁾ / 0,9 ²⁾		0,9	1,9	3,2	6,0	9,4	13,5			
			R120	0,2 ¹⁾ / 0,7 ²⁾		0,8	1,6	2,8	5,2	8,1	11,6			
	FAZ II Plus R / HCR	$N_{Rk,s,fi}$	R30	0,6 ¹⁾ / 0,9 ²⁾		3,6	7,8	11,5	21,8	34,3	49,4			
			R60	0,4 ¹⁾ / 0,9 ²⁾		2,3	4,8	7,1	13,2	20,7	29,3			
			R90	0,3 ¹⁾ / 0,9 ²⁾		1,9	3,8	5,7	10,5	18,3	26,4			
			R120 [kN]	0,2 ¹⁾ / 0,7 ²⁾		1,6	3,3	4,9	8,6	17,3	25,0			
Characteristic resistance Concrete cone failure	$N_{Rk,c,fi}$	R30	$7,7 \cdot h_{ef}^{1,5} \cdot (20)^{0,5} \cdot h_{ef} / 200 / 1000$											
		- R90												
		R120	$7,7 \cdot h_{ef}^{1,5} \cdot (20)^{0,5} \cdot h_{ef} / 200 / 1000 \cdot 0,8$											
Characteristic resistance pullout failure	$N_{Rk,p,fi}$	R30	0,4	0,9	2,0	2,2	3,3	3,0	5,0	4,5	6,8	8,6	12,0	
		R60		0,8										
		R90	0,3	0,5	1,6	1,7	2,6	2,4	4,0	3,6	5,4	6,9	9,6	
		R120												

Table C3.2: Characteristic values of shear resistance under fire exposure

FAZ II Plus				R30		R60	
				$V_{Rk,s,fi,30}$ [kN]	$M^0_{Rk,s,fi,30}$ [Nm]	$V_{Rk,s,fi,60}$ [kN]	$M^0_{Rk,s,fi,60}$ [Nm]
M6	$h_{ef} \geq$	40	[mm]	0,6 ¹⁾ / 0,9 ²⁾	0,5 ¹⁾ / 0,2 ²⁾	0,4 ¹⁾ / 0,9 ²⁾	0,3 ¹⁾ / 0,1 ²⁾
M8		35		1,8	1,4	1,6	1,2
M10		40		3,6	3,6	2,9	3,0
M12		50		6,3	7,8	4,9	6,4
M16		65		11,7	19,9	9,1	16,3
M20		100		18,2	39,0	14,2	31,8
M24		125		26,3	67,3	20,5	55,0

FAZ II Plus				R90		R120	
				$V_{Rk,s,fi,90}$ [kN]	$M^0_{Rk,s,fi,90}$ [Nm]	$V_{Rk,s,fi,120}$ [kN]	$M^0_{Rk,s,fi,120}$ [Nm]
M6	$h_{ef} \geq$	40	[mm]	0,3 ¹⁾ / 0,9 ²⁾	0,2 ¹⁾ / 0,1 ²⁾	0,2 ¹⁾ / 0,7 ²⁾	0,2 ¹⁾ / 0,1 ²⁾
M8		35		1,3	1,0	1,2	0,8
M10		40		2,2	2,4	1,9	2,1
M12		50		3,5	5,0	2,8	4,3
M16		65		6,6	12,6	5,3	11,0
M20		100		10,3	24,6	8,3	21,4
M24		125		14,8	42,6	11,9	37,0

Concrete pryout failure according to EN 1992-4:2018

1) FAZ II Plus

2) FAZ II Plus R / FAZ II Plus HCR

fischer Bolt Anchor FAZ II Plus, FAZ II Plus R, FAZ II Plus HCR

Performances

Characteristic values of resistance under fire exposure

Annex C3

Appendix 13 / 19

Table C4.1: Characteristic values of shear resistance under fire exposure

FAZ II Plus R, FAZ II Plus HCR			R30		R60		
			$V_{Rk,s,fi,30}$ [kN]	$M^0_{Rk,s,fi,30}$ [Nm]	$V_{Rk,s,fi,60}$ [kN]	$M^0_{Rk,s,fi,60}$ [Nm]	
M6	h _{ef} ≥	40	[mm]	0,6 ¹⁾ / 0,9 ²⁾	0,5 ¹⁾ / 0,2 ²⁾	0,4 ¹⁾ / 0,9 ²⁾	0,3 ¹⁾ / 0,1 ²⁾
M8		35		3,6	3,7	2,3	2,4
M10		40		7,8	10,1	4,8	6,2
M12		50		11,5	17,9	7,1	11,1
M16		65		21,8	46,2	13,2	27,9
M20		100		34,3	90,9	20,7	54,9
M24		125		49,4	157,2	29,3	93,1

FAZ II Plus R, FAZ II Plus HCR			R90		R120		
			$V_{Rk,s,fi,90}$ [kN]	$M^0_{Rk,s,fi,90}$ [Nm]	$V_{Rk,s,fi,120}$ [kN]	$M^0_{Rk,s,fi,120}$ [Nm]	
M6	h _{ef} ≥	40	[mm]	0,3 ¹⁾ / 0,9 ²⁾	0,2 ¹⁾ / 0,1 ²⁾	0,2 ¹⁾ / 0,7 ²⁾	0,2 ¹⁾ / 0,1 ²⁾
M8		35		1,9	1,9	1,6	1,7
M10		40		3,8	4,9	3,3	4,3
M12		50		5,7	8,8	4,9	7,6
M16		65		10,5	22,1	8,6	18,3
M20		100		18,3	48,6	17,3	45,9
M24		125		26,4	84,0	25,0	79,4

1) FAZ II Plus

2) FAZ II Plus R / FAZ II Plus HCR

Concrete pryout failure according to EN 1992-4:2018

Table C4.2: Minimum spacings and minimum edge distances of fasteners under fire exposure for tension and shear load

Size	FAZ II Plus, FAZ II Plus R, FAZ II Plus HCR						
	M6	M8	M10	M12	M16	M20	M24
Spacing s_{min}	Annex C5						
Edge distance c_{min} [mm]	$c_{min} = 2 \cdot h_{ef}$, for fire exposure from more than one side $c_{min} \geq 300$ mm						

fischer Bolt Anchor FAZ II Plus, FAZ II Plus R, FAZ II Plus HCR

Performances

Characteristic values of resistance under fire exposure

Annex C4

Appendix 14 / 19

Table C5.1: Minimum thickness of concrete members, minimum spacing and minimum edge distance

Size	FAZ II Plus, FAZ II Plus R, FAZ II Plus HCR							
	M6	M8	M10	M12	M16	M20	M24	
Minimum edge distance								
Uncracked concrete	40	40	45	55	65	95	135	
Cracked concrete						85	100	
Corresponding	according to Annex C6							
Minimum thickness of concrete member	80		100	140	160	200		
Thickness of concrete member	max. $\{h_{min}; 1,5 \cdot h_{ef}\}$							
Minimum spacing								
Uncracked concrete	35	40	40	50	65	95	100	
Cracked concrete		35						
Corresponding	according to Annex C6							
Minimum thickness of concrete member	80		100	140	160	200		
Thickness of concrete member	max. $\{h_{min}; 1,5 \cdot h_{ef}\}$							
Minimum splitting area								
Uncracked concrete	5,1	18	37	54	67	100	117,5	
Cracked concrete		1,5	12	27	40	50	77	87,5

Table C5.2: Minimum spacing and minimum edge distances - calculated values for **cracked concrete with one edge** (c_2 and $c_3 \geq 1,5 c_1$)

Type of anchor / size	FAZ II Plus, FAZ II Plus R, FAZ II Plus HCR											
	M6	M8	M10	M12	M16	M20	M24					
Effective anchorage depth	40	35	45	40	60	50	70	65	85	100	125	
Minimum thickness of concrete member	80		85	80	120	100	140	140	180	160	200	
Minimum spacing	35		40		50		65		95	100		
	for $c \geq$		40	100	65	120	80	100	75	130	115	
Minimum edge distance	40		60	45	70	55	65		85	100		
	for $s \geq$		35	160	90	190	125	165	85	230	140	

fischer Bolt Anchor FAZ II Plus, FAZ II Plus R, FAZ II Plus HCR

Performances

Minimum thickness of member, minimum spacing and edge distances

Annex C5

Appendix 15 / 19

Determination of $A_{sp,ef}$ for each existing free edge

Splitting failure applied for minimum edge distance and spacing in depending on h_{ef}

Definition Index:

cal = calculatory

e.g.: $s_{x,y}$

x = load direction

y = number anchor plate

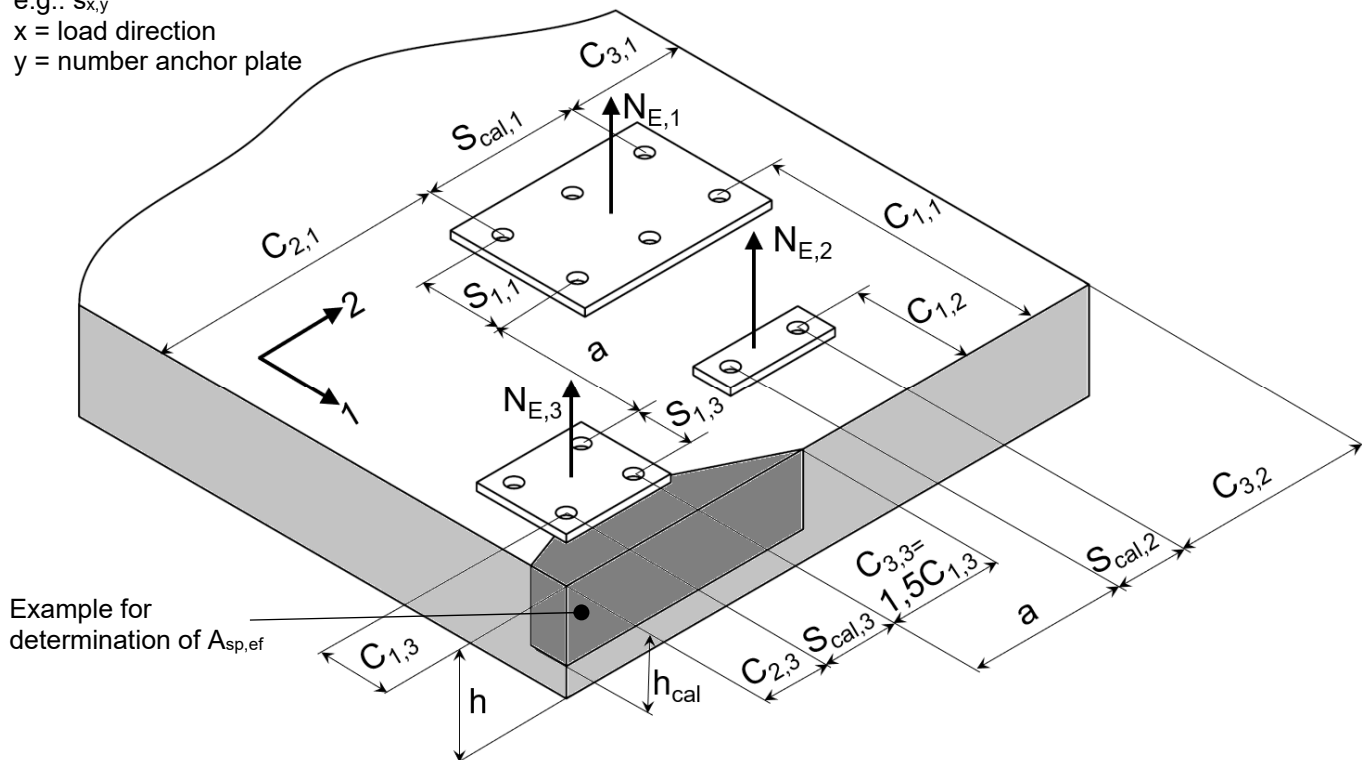

Example for determination of $A_{sp,ef}$

Example for different anchor plates: For considering all free edges the direction 1 and 2 must be swapped.

General formulation for each free edge: $A_{sp,ef} = (C_2 + s_{cal} + C_3) \cdot h_{cal} \geq (n/2) \cdot A_{sp,req}$

with:

Edge distance C_1 : $C_{min} \leq C_1$

Edge distance C_2 : $C_{min} \leq C_2 \leq 1,5 \cdot C_1$

Edge distance C_3 : $C_{min} \leq C_3 \leq 1,5 \cdot C_1$

Calculation spacing, distance between outer anchors s_{cal} : $s_{min} \leq s_{cal} \leq 3,0 \cdot C_1$

Distance between group of anchors a : For $a \geq 3,0 \cdot C_1$ no influence between the anchor groups is taken into account.

Number of anchors n of an anchor plate as well close and parallel to the edge

Effective member thickness h_{cal} : $h_{min} \leq h$; $h_{cal} \leq h$; $h_{cal} \leq (h_{ef} + 1,5 \cdot C_1)$

C_1 , C_2 , C_3 , h and s_{cal} have to be set in way that the requirement is fulfilled

For the calculation of minimum spacing and minimum edge distance of fasteners in combination with different embedment depths and thicknesses of concrete members the following equation shall be fulfilled:

$$A_{sp,req} < A_{sp,ef}$$

$A_{sp,req}$ = required splitting area (according to Annex C 5)

$A_{sp,ef}$ = effective splitting area

(Figure not to scale)

fischer Bolt Anchor FAZ II Plus, FAZ II Plus R, FAZ II Plus HCR

Performances

Minimum thickness of member, minimum spacings and edge distances

Annex C6

Appendix 16 / 19

Table C7.1: Characteristic values of tension and shear resistance under seismic action category C1

Size		FAZ II Plus, FAZ II Plus R, FAZ II Plus HCR								
		M6	M8		M10	M12	M16	M20	M24	
Effective embedment depth	h_{ef} [mm]	- 2)	40 - <45	45-90	40-100	50-125	85-160	100-180	125	
With filling of the annular gap	α_{gap} [-]		1,0							
Without filling of the annular gap			0,5							
Steel failure $N_{Rk,s,C1} = N_{Rk,s}$; $\gamma_{Ms,C1} = \gamma_{Ms}$ (see Annex C1)										
Pullout failure										
Characteristic resistance in cracked concrete C1	$N_{Rk,p,C1}$ [kN]	- 2)	5,1	7,4	11,6	20,0	27,0	34,4	48,1	
Installation sensitivity factor	γ_{inst} [-]	1,0								
Concrete cone failure and splitting failure $N_{Rk,c,C1} = N_{Rk,c}$; $N_{Rk,sp,C1} = N_{Rk,sp}$ (see Annex C1)										
Steel failure without lever arm										
Characteristic resistance C1	FAZ II Plus									
		h_{ef} [mm]	- 2)	45-90	60-100	70-125	85-160	100-180	125	102,6
	Without filling	$V_{Rk,s,C1}$ [kN]		14,8	23,6	33,3	58,1	71,2		
	With			16,5	24,6	39,9	59,3	85,6		
		h_{ef} [mm]		40-<45	40-<60	50-<70	- 2)			
	Without filling	$V_{Rk,s,C1}$ [kN]		- 2)		32,9	- 2)			
	With			15,6	19,7	39,9	- 2)			
	FAZ II Plus R									
		h_{ef} [mm]	- 2)	45-90	60-100	70-125	85-160	100-180	125	126,5
	Without filling	$V_{Rk,s,C1}$ [kN]		16,0	23,9	37,9	60,4	86,3		
	With			24,8	43,4	62,6	94,3			
		h_{ef} [mm]		40-<45	40-<60	50-<70	- 2)			
	Without filling	$V_{Rk,s,C1}$ [kN]		- 2)		37,5	- 2)			
	With			15,1	19,9	43,4	- 2)			
	FAZ II Plus HCR									
		h_{ef} [mm]	- 2)	45-90	60-100	70-125	85-160	100-180	125	126,5
Without filling	$V_{Rk,s,C1}$ [kN]	15,8		21,3	37,9	60,4	86,3			
With		25,1		41,3	62,6	94,3				
	h_{ef} [mm]	40-<45		40-<60	50-<70	- 2)				
Without filling	$V_{Rk,s,C1}$ [kN]	- 2)		37,5	- 2)					
With		15,0		20,1	41,3	- 2)				
Partial factor for steel failure	$\gamma_{Ms,C1}^{1)}$ [-]	1,25								
<p>1) In absence of other national regulations</p> <p>2) No performance assessed</p>										
fischer Bolt Anchor FAZ II Plus, FAZ II Plus R, FAZ II Plus HCR								Annex C7 Appendix 17 / 19		
<p>Performances</p> <p>Characteristic values of tension and shear resistance under seismic action category C1</p>										

Table C8.1: Characteristic values of tension and shear resistance under seismic action category C2

Size		FAZ II Plus, FAZ II Plus R, FAZ II Plus HCR							
		M6	M8	M10	M12	M16	M20	M24	
With filling of the annular gap		α_{gap} [-]	-2)	1,0					
Without filling of the annular gap				0,5					
Steel failure $N_{Rk,s,C2} = N_{Rk,s}$; $\gamma_{Ms,C2} = \gamma_{Ms}$ (see Annex C1)									
Pullout failure									
Characteristic resistance in cracked concrete C2	h_{ef} [mm]	-2)	60-100	70-125	85-160	100-180	125		
	$N_{Rk,p,C2}$ [kN]		5,1	7,4	21,5	30,7	39,6		
	h_{ef} [mm]		40 - <60	50 - <70	65 - <85	-2)			
	$N_{Rk,p,C2}$ [kN]		2,7	4,4	16,4				
Installation sensitivity factor		γ_{inst} [-]	1,0						
Concrete cone failure and splitting failure $N_{Rk,c,C2} = N_{Rk,c}$; $N_{Rk,sp,C2} = N_{Rk,sp}$ (see Annex C1)									
Steel failure without lever arm									
FAZ II Plus									
Characteristic resistance C2	h_{ef} [mm]	-2)	60-100	70-125	85-160	100-180	125		
	Without filling $V_{Rk,s,C2}$ [kN]		17,6	27,8	37,6	62,2	70,6		
	With filling $V_{Rk,s,C2}$ [kN]		20,5	30,5	52,4	68,5	102,6		
	h_{ef} [mm]		40 - <60	50 - <70	65 - <85	-2)			
	Without filling $V_{Rk,s,C2}$ [kN]		14,1	24,4	31,2				
	With filling $V_{Rk,s,C2}$ [kN]		14,7	30,5	52,4				
	FAZ II Plus R								
	h_{ef} [mm]		-2)	60-100	70-125	85-160	100-180	125	
	Without filling $V_{Rk,s,C2}$ [kN]			17,8	31,6	39,1	70,5	87,0	
	With filling $V_{Rk,s,C2}$ [kN]			20,7	33,2	55,2	104,9	126,5	
	h_{ef} [mm]			40 - <60	50 - <70	65 - <85	-2)		
	Without filling $V_{Rk,s,C2}$ [kN]			14,3	27,8	32,4			
With filling $V_{Rk,s,C2}$ [kN]	14,9	33,2		55,2					
FAZ II Plus HCR									
h_{ef} [mm]	-2)	60-100		70-125	85-160	100-180	125		
Without filling $V_{Rk,s,C2}$ [kN]		15,9		31,6	39,1	70,5	87,0		
With filling $V_{Rk,s,C2}$ [kN]		20,9			55,2	104,9	126,5		
h_{ef} [mm]		40 - <60		50 - <70	65 - <85	-2)			
Without filling $V_{Rk,s,C2}$ [kN]		12,8		27,8	32,4				
With filling $V_{Rk,s,C2}$ [kN]		15,1	31,6	55,2					
Partial factor for steel		$\gamma_{Ms,C2}^{1)}$ [-]	1,25						

¹⁾ In absence of other national regulations

²⁾ No performance assessed

fischer Bolt Anchor FAZ II Plus, FAZ II Plus R, FAZ II Plus HCR

Performances

Characteristic values of resistance under tension and shear loads under seismic action category C2

Annex C8

Appendix 18 / 19

Table C9.1: Displacements under static and quasi static tension loads

Size	FAZ II Plus, FAZ II Plus R, FAZ II Plus HCR						
	M6	M8	M10	M12	M16	M20	M24
Displacement – factor for tensile load¹⁾							
δ_{N0} - factor in cracked concrete	0,13	0,22	0,12	0,09	0,08	0,07	0,05
$\delta_{N\infty}$ - factor [mm/kN]	1,00	0,78	0,40	0,19	0,09		0,07
δ_{N0} - factor in uncracked concrete	0,16	0,07	0,05	0,06		0,05	0,04
$\delta_{N\infty}$ - factor	0,24	0,29	0,21	0,14	0,10	0,06	0,05

Table C9.2: Displacements under static and quasi static shear loads

Size	FAZ II Plus, FAZ II Plus R, FAZ II Plus HCR						
	M6	M8	M10	M12	M16	M20	M24
Displacement – factor for shear load²⁾							
FAZ II Plus							
δ_{V0} - factor	0,6	0,35	0,37	0,27	0,10	0,09	0,07
$\delta_{V\infty}$ - factor in cracked or uncracked concrete [mm/kN]	0,9	0,52	0,55	0,40	0,14	0,15	0,11
FAZ II Plus R, FAZ II Plus HCR							
δ_{V0} - factor	0,6	0,23	0,19	0,18	0,10	0,11	0,07
$\delta_{V\infty}$ - factor	0,9	0,35	0,29	0,27	0,15	0,17	0,11

¹⁾ Calculation of effective displacement:

$$\delta_{N0} = \delta_{N0} - \text{factor} \cdot N$$

$$\delta_{N\infty} = \delta_{N\infty} - \text{factor} \cdot N$$

N = Action tension loading

²⁾ Calculation of effective displacement:

$$\delta_{V0} = \delta_{V0} - \text{factor} \cdot V$$

$$\delta_{V\infty} = \delta_{V\infty} - \text{factor} \cdot V$$

V = Action shear loading

Table C9.3: Displacements under tension loads for category C2 for all embedment depths

Size	FAZ II Plus, FAZ II Plus R, FAZ II Plus HCR						
	M6	M8	M10	M12	M16	M20	M24
DLS $\delta_{N,C2}$ (DLS) [mm]	- ¹⁾		2,7	4,4		5,6	4,8
ULS $\delta_{N,C2}$ (ULS)	- ¹⁾		11,5	13,0	12,3	14,4	15,2

¹⁾ No performance assessed

Table C9.4: Displacements under shear loads for category C2 for all embedment depths

Size	FAZ II Plus, FAZ II Plus R, FAZ II Plus HCR						
	M6	M8	M10	M12	M16	M20	M24
DLS without filling $\delta_{V,C2}$ (DLS) [mm]	- ¹⁾		5,0		4,8	4,2	
ULS without filling $\delta_{V,C2}$ (ULS)	- ¹⁾		7,8	6,3	8,8	6,3	7,4
DLS with filling $\delta_{V,C2}$ (DLS)	- ¹⁾		1,2		2,0	4,2	
ULS with filling $\delta_{V,C2}$ (ULS)	- ¹⁾		4,2	5,8	3,1	4,4	7,4

¹⁾ No performance assessed

fischer Bolt Anchor FAZ II Plus, FAZ II Plus R, FAZ II Plus HCR

Performances

Displacements under tension and shear loads

Annex C9

Appendix 19 / 19