

## ΔΗΛΩΣΗ ΕΠΙΔΟΣΕΩΝ

### DoP 0353

για fischer χημικό αγκύριο Highbond-Anchor FHB / FHB dyn / FDA (συγκολλημένο αγκύριο εκτόνωσης για χρήση σε σκυρόδεμα)

EL

1. Μοναδικός κωδικός ταυτοποίησης του τύπου του προϊόντος: DoP 0353
2. Προβλεπόμενη(-ες) χρήση(-εις): Μεταγενέστερη αγκύρωση σε ρηγματωμένο ή μη ρηγματωμένο σκυρόδεμα, δείτε το παράρτημα, ειδικά τα παραρτήματα B1 - B19.
3. Κατασκευαστής: fischerwerke GmbH & Co. KG, Klaus-Fischer-Str. 1, 72178 Waldachtal, Γερμανία
4. Εξουσιοδοτημένος αντιπρόσωπος: -
5. Σύστημα/συστήματα AVCP (αξιολόγηση και επαλήθευση της σταθερότητας της επίδοσης): 1
6. Ευρωπαϊκό έγγραφο αξιολόγησης: EAD 330499-02-0601, Edition 12/2023  
 Ευρωπαϊκή τεχνική αξιολόγηση: ETA-06/0171; 2024-02-15  
 Οργανισμός τεχνικής αξιολόγησης: DIBt- Deutsches Institut für Bautechnik  
 Κοινοποιημένος(-οι) οργανισμός(-οι): 2873 TU Darmstadt
7. Δηλωθείσα(-ες) επίδοση(-εις):  
Μηχανική αντίσταση και σταθερότητα (BWR1)  
**Χαρακτηριστική αντίσταση σε εφελκυστικό φορτίο (στατικό και σχεδόν στατικό):**
  - 1) Αντίσταση σε αστοχία χάλυβα: δείτε το παράρτημα, ειδικά τα Παραρτήματα C1
  - 2) Αντίσταση σε αστοχία από εξόλκευση: δείτε το παράρτημα, ειδικά τα Παραρτήματα C2,C3
  - 3) Αντίσταση σε αστοχία από κώνο σκυροδέματος: δείτε το παράρτημα, ειδικά τα Παραρτήματα C2
  - 4) Απόσταση από ακμή για αποφυγή θραύσης από φορτίο: δείτε το παράρτημα, ειδικά τα Παραρτήματα C2
  - 5) Ανθεκτικότητα: δείτε το παράρτημα, ειδικά τα Παραρτήματα C2, C3
  - 6) ροπή σύσφιξης: δείτε το παράρτημα, ειδικά τα Παραρτήματα B5-B8
  - 7) Ελάχιστη απόσταση από ακμή και μεταξύ αγκυρίων, πάχος μέλους: δείτε το παράρτημα, ειδικά τα Παραρτήματα B5-B8**Χαρακτηριστική αντίσταση σε διατμητικό φορτίο (στατικό και σχεδόν στατικό):**
  - 8) Αντίσταση σε αστοχία χάλυβα: δείτε το παράρτημα, ειδικά τα Παραρτήματα C1
  - 9) Αντίσταση σε ολίσθηση: δείτε το παράρτημα, ειδικά τα Παραρτήματα C2
  - 10) Αντίσταση σε αστοχία ακμης σκυροδέματος: δείτε το παράρτημα, ειδικά τα Παραρτήματα C2**Μετατόπιση σε βραχείας διάρκειας και μακράς διάρκειας φόρτιση:**
  - 11) Μετατόπιση σε βραχείας διάρκειας και μακράς διάρκειας φόρτιση: δείτε το παράρτημα, ειδικά τα Παραρτήματα C4
  - 12) Αντοχή σε οπλισμένο με χαλύβδινες ίνες σκυρόδεμα: δείτε το παράρτημα, ειδικά τα Παραρτήματα B3, B4, C1-C4**Χαρακτηριστική αντίσταση και μετακινήσεις για τις σεισμικές κατηγορίες C1 και C2 (προαιρετικά):**
  - 13) Αντίσταση σε εφελκυσμό, κατηγορία C1: NPD
  - 14) Αντίσταση σε εφελκυσμό, κατηγορία C2: NPD
  - 15) Αντίσταση σε διάτμηση, κατηγορία C1: NPD
  - 16) Αντίσταση σε διάτμηση, κατηγορία C2: NPDΑσφάλεια σε περίπτωση φωτιάς (BWR 2)
  - 17) Αντίδραση σε φωτιά: Κατηγορίας (A1)**Αντίσταση στη φωτιά:**
  - 18) Αντίσταση σε φωτιά για αστοχία χάλυβα (εφελκυστικό φορτίο): NPD
  - 19) Αντοχή δεσμού σε συνθήκες πυρκαγιάς: NPD
  - 20) Αντίσταση σε φωτιά για αστοχία χάλυβα (διατμητικό φορτίο): NPDΥγιεινή, υγεία και περιβάλλον (BWR 3)
  - 21) Περιεχόμενο, εκπομπή ή/και απελευθέρωση επικίνδυνων ουσιών: NPD
8. Κατάλληλη τεχνική τεκμηρίωση και/ή ειδική τεχνική τεκμηρίωση: -

Η επίδοση του προϊόντος που ταυτοποιείται ανωτέρω είναι σύμφωνη με τη (τις) δηλωθείσα(-ες) επίδοση(-εις). Αυτή η δήλωση επιδόσεων εκδίδεται σύμφωνα με τον Κανονισμό (ΕΕ) Αρ. 305/2011 με αποκλειστική ευθύνη του κατασκευαστή που προσδιορίζεται παραπάνω.

Υπογραφή για λογαριασμό και εξ ονόματος του κατασκευαστή από:



Dr.-Ing. Oliver Geibig, Γενικός Διευθυντής Επιχειρηματικών Μονάδων & Μηχανικής  
Tumlingen, 2024-02-23

Jürgen Grün, Γενικός Διευθυντής Χημικών & Ποιότητας

Αυτή η Δήλωση Επιδόσεων μεταφράστηκε σε διάφορες γλώσσες. Σε περίπτωση που υπάρχει αμφιβολία για τη μετάφραση, υπερισχύει πάντα η αγγλική έκδοση.

Το παράρτημα περιλαμβάνει προαιρετικές και συμπληρωματικές πληροφορίες στα αγγλικά, που ξεπερνούν τις (οριζόμενες σε άλλες γλώσσες) νόμιμες απαιτήσεις.

Translation guidance Essential Characteristics and Performance Parameters for Annexes

**Οδηγίες Μετάφρασης των βασικών χαρακτηριστικών και απόδοσης για τα παραρτήματα**

Mechanical resistance and stability (BWR 1)		
<b>Μηχανική αντίσταση και σταθερότητα (BWR1)</b>		
Characteristic resistance to tension load (static and quasi-static loading):		
<b>Χαρακτηριστική αντίσταση σε εφελκυστικό φορτίο (στατικό και σχεδόν στατικό):</b>		
1	Resistance to steel failure: <b>Αντίσταση σε αστοχία χάλυβα:</b>	$N_{Rk,s}$ [kN]
2	Resistance to combined pull-out and concrete cone failure: <b>Αντίσταση για συνδυασμένη αστοχία από ολίσθηση και κώνο σκυροδέματος:</b>	$T_{Rk}$ and/or $\tau_{Rk,100}$ [N/mm <sup>2</sup> ], $\psi_c, \psi_{sus}, \psi_{sus,100}$ [-] (BF)
	Resistance to pull-out failure: <b>Αντίσταση σε αστοχία από εξόλκευση:</b>	$N_{Rk,p}$ and/or $N_{Rk,p,100}$ [kN], $\psi_c$ [-] (BEF)
3	Resistance to concrete cone failure: <b>Αντίσταση σε αστοχία από κώνο σκυροδέματος:</b>	$c_{cr,N}$ [mm], $k_{cr,N}$ , $k_{ucr,N}$ [-]
4	Edge distance to prevent splitting under load: <b>Απόσταση από ακμή για αποφυγή θραύσης από φορτίο:</b>	$c_{cr,sp}$ [mm]
5	Robustness: <b>Ανθεκτικότητα:</b>	$\gamma_{inst}$ [-]
6	Maximum installation torque: <b>Μέγιστη ροπή σύσφιξης:</b>	$\max T_{inst}$ [Nm] (BF)
	Installation torque: <b>ροπή σύσφιξης:</b>	$T_{inst}$ [Nm] (BEF)
7	Minimum edge distance, spacing and member thickness: <b>Ελάχιστη απόσταση από ακμή και μεταξύ αγκυρίων, πάχος μέλους:</b>	$c_{min}, s_{min}, h_{min}$ [mm]
Characteristic resistance to shear load (static and quasi-static loading):		
<b>Χαρακτηριστική αντίσταση σε διατμητικό φορτίο (στατικό και σχεδόν στατικό):</b>		
8	Resistance to steel failure: <b>Αντίσταση σε αστοχία χάλυβα:</b>	$V_{Rk,s}^0$ [kN], $M_{Rk,s}^0$ [Nm], $k_7$ [-]
9	Resistance to pry-out failure: <b>Αντίσταση σε ολίσθηση:</b>	$k_8$ [-]
10	Resistance to concrete edge failure: <b>Αντίσταση σε αστοχία ακμής σκυροδέματος:</b>	$d_{nom}, l_f$ [mm]
Displacements under short-term and long-term loading:		
<b>Μετατόπιση σε βραχείας διάρκειας και μακράς διάρκειας φόρτιση:</b>		
11	Displacements under short-term and long-term loading: <b>Μετατόπιση σε βραχείας διάρκειας και μακράς διάρκειας φόρτιση:</b>	$\delta_0, \delta_\infty$ [mm or mm/(N/mm <sup>2</sup> )]
12	Resistance in steel fibre reinforced concrete: <b>Αντοχή σε οπλισμένο με χαλύβδινες ίνες σκυρόδεμα:</b>	Description
Characteristic resistance and displacements for seismic performance categories C1 and C2:		
<b>Χαρακτηριστική αντίσταση και μετακινήσεις για τις σεισμικές κατηγορίες C1 και C2 (προαιρετικά):</b>		
13	Resistance to tension for seismic performance category C1 <b>Αντίσταση σε εφελκυσμό, κατηγορία C1:</b>	$N_{Rk,s,C1}$ [kN] (all) $T_{Rk,C1}$ [N/mm <sup>2</sup> ] (BF) $N_{Rk,p,C1}$ [kN] (BEF)
14	Resistance to tension for seismic performance category C2 <b>Αντίσταση σε εφελκυσμό, κατηγορία C2:</b>	$N_{Rk,s,C2}$ [kN] (all) $T_{Rk,C2}$ [N/mm <sup>2</sup> ] (BF) $N_{Rk,p,C2}$ [kN] (BEF) $\delta_{N,C2}$ [mm] (all)
15	Resistance to shear for seismic performance category C1 <b>Αντίσταση σε διάτμηση, κατηγορία C1:</b>	$V_{Rk,s,C1}$ [kN] (all)
16	Resistance to shear for seismic performance category C2 <b>Αντίσταση σε διάτμηση, κατηγορία C2:</b>	$V_{Rk,s,C2}$ [kN] (all) $\delta_{V,C2}$ [mm] (all)
Safety in case of fire (BWR 2)		
<b>Ασφάλεια σε περίπτωση φωτιάς (BWR 2)</b>		
17	Reaction to fire <b>Αντίδραση σε φωτιά:</b>	Class Κατηγορίας (A1)
Resistance to fire		
<b>Αντίσταση στη φωτιά:</b>		
18	Fire resistance to steel failure (tension load): <b>Αντίσταση σε φωτιά για αστοχία χάλυβα (εφελκυστικό φορτίο):</b>	$N_{Rk,s,fi}$ [kN]
19	Bond resistance under fire conditions: <b>Αντοχή δεσμού σε συνθήκες πυρκαγιάς:</b>	$k_{fi,p}(\theta)$ [-], $T_{Rk,fi}(\theta)$ [N/mm <sup>2</sup> ] (BF)
20	Fire resistance to steel failure under shear loading: <b>Αντίσταση σε φωτιά για αστοχία χάλυβα (διατμητικό φορτίο):</b>	$V_{Rk,s,fi}$ [kN], $M_{Rk,s,fi}^0$ [Nm]
Hygiene, health and the environment (BWR 3)		
<b>Υγιεινή, υγεία και περιβάλλον (BWR 3)</b>		
21	Content, emission and/or release of dangerous substances: <b>Περιεχόμενο, εκπομπή ή/και απελευθέρωση επικίνδυνων ουσιών:</b>	Description/Level

## Specific Part

### 1 Technical description of the product

The Fischer Highbond-Anchor FHB / FHB dyn / FDA is a bonded expansion fastener consisting of an injection cartridge FIS HB and a steel element. The steel element is made of zinc plated or stainless steel.

The load transfer is realized by mechanical interlock of several cones in the bonding mortar and a combination of bonding and friction forces in the concrete.

The product description is given in Annex A.

### 2 Specification of the intended use in accordance with the applicable European Assessment Document

The performances given in Section 3 are only valid if the anchor is used in compliance with the specifications and conditions given in Annex B.

The verifications and assessment methods on which this European Technical Assessment is based lead to the assumption of a working life of the anchor of at least 50 years. The indications given on the working life cannot be interpreted as a guarantee given by the producer, but are to be regarded only as a means for choosing the right products in relation to the expected economically reasonable working life of the works.

### 3 Performance of the product and references to the methods used for its assessment

#### 3.1 Mechanical resistance and stability (BWR 1)

Essential characteristic	Performance
Characteristic resistance to tension load (static and quasi-static loading)	See Annex C1 to C3, B5 to B8
Characteristic resistance to shear load (static and quasi-static loading)	See Annex C1 and C2
Displacements under short-term and long-term loading	See Annex C4
Characteristic resistance and displacements for seismic performance categories C1 and C2	No performance assessed

#### 3.2 Safety in case of fire (BWR 2)

Essential characteristic	Performance
Reaction to fire	Class A1

#### 3.3 Hygiene, health and the environment (BWR 3)

Essential characteristic	Performance
Content, emission and/or release of dangerous substances	No performance assessed

**4 Assessment and verification of constancy of performance (AVCP) system applied, with reference to its legal base**

In accordance with the European Assessment Document EAD 330499-02-0601 the applicable European legal act is: [96/582/EC].

The system to be applied is: 1

## Installation conditions part 1, FHB / FHB N

fischer Highbond-Anchor FHB / FHB N with fischer injection system FIS HB

### Pre-positioned installation

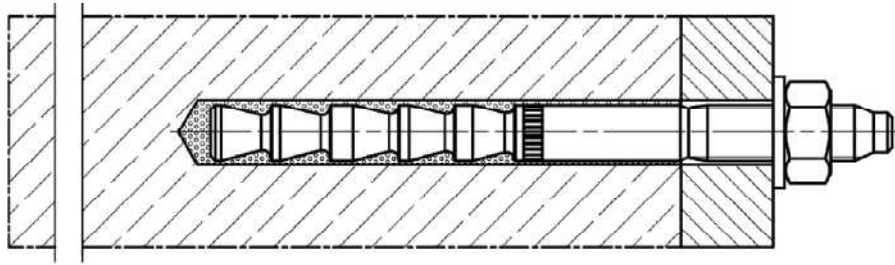

### Pre-positioned or push through installation with subsequently injected fischer filling disc (annular gap filled with mortar)

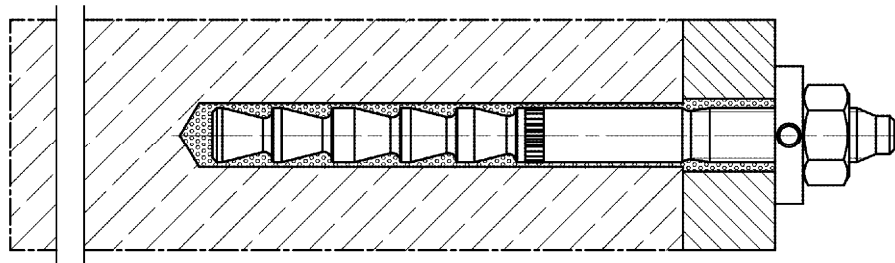

Figures not to scale

fischer Highbond-Anchor FHB / FHB dyn / FDA

#### Product description

Installation conditions part 1, fischer Highbond-Anchor FHB / FHB N

**Annex A1**

Appendix 3 / 38

## Installation conditions part 2, FHB dyn

fischer Highbond-Anchor dynamic FHB dyn with fischer injection system FIS HB

Pre-positioned installation without shear force sleeve, FHB dyn (annular gap filled with mortar)

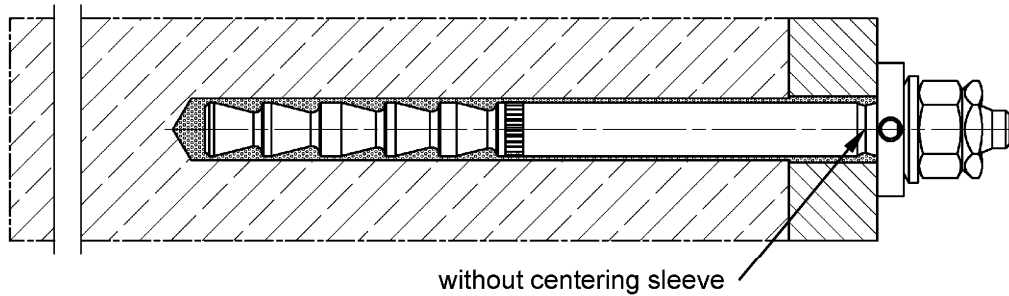

Push through installation without shear force sleeve, FHB dyn (annular gap filled with mortar)

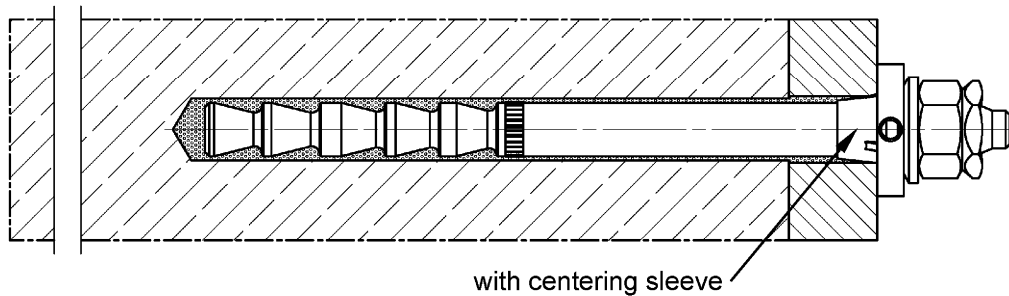

Push through installation with shear force sleeve, FHB dyn V (annular gap filled with mortar)

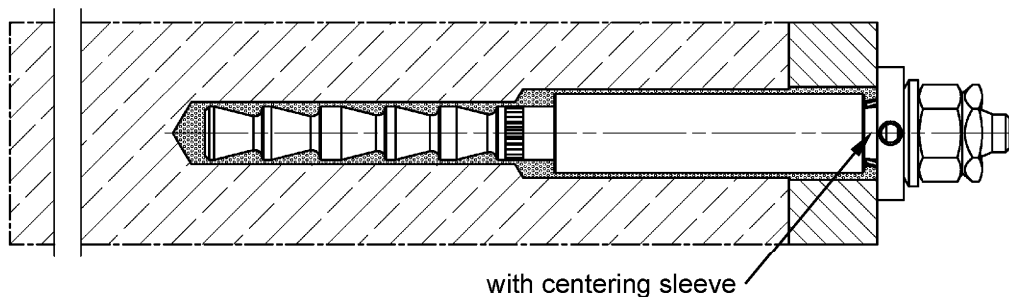

Figures not to scale

fischer Highbond-Anchor FHB / FHB dyn / FDA

**Product description**  
Installation conditions part 2, fischer Highbond-Anchor FHB dyn

**Annex A2**

Appendix 4 / 38

## Installation conditions part 3, FDA

fischer Dynamic-Anchor FDA with fischer injection system FIS HB

Push through installation (annular gap filled with mortar)

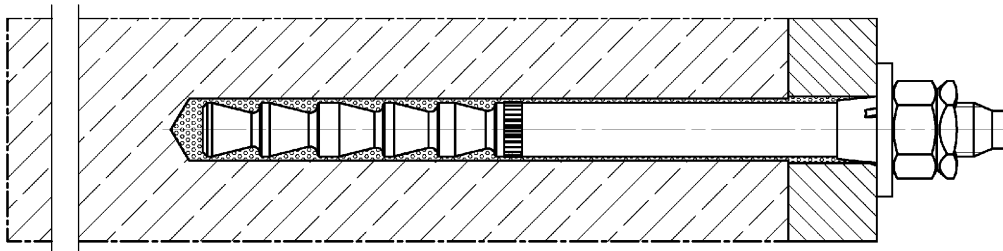

Figures not to scale

fischer Highbond-Anchor FHB / FHB dyn / FDA

**Product description**

Installation conditions part 3, fischer Dynamic-Anchor FDA

**Annex A3**

Appendix 5 / 38

## Overview system components part 1

### Injection cartridge (shuttle cartridge) with sealing cap

Size: 360 ml, 825 ml

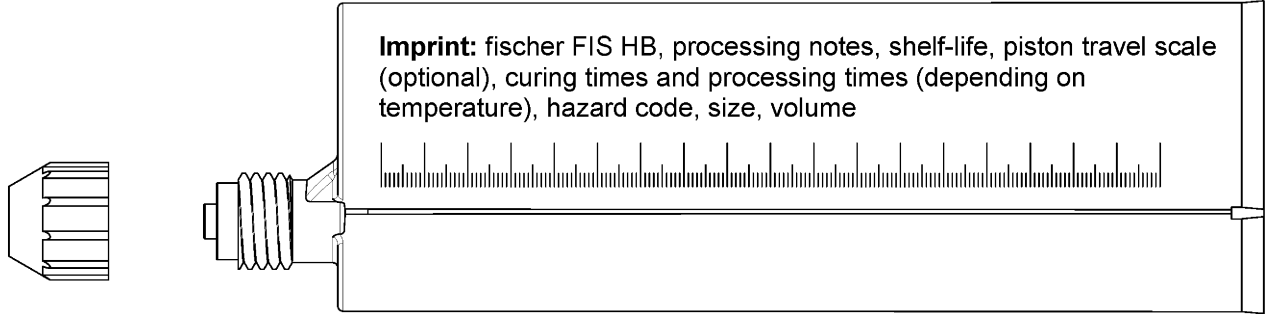

### Injection cartridge (coaxial cartridge) with sealing cap

Size: 150 ml, 300 ml, 380 ml, 400 ml, 410 ml

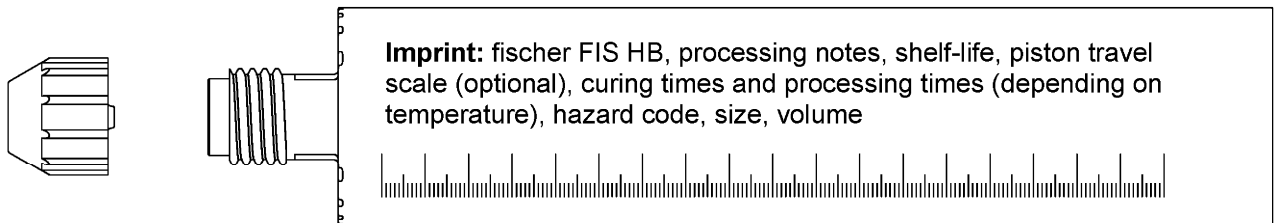

### Static mixer FIS MR Plus for injection cartridges up to 410 ml

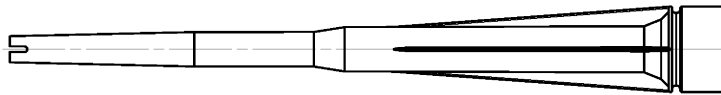

### Static mixer FIS JMR for injection cartridge 825 ml

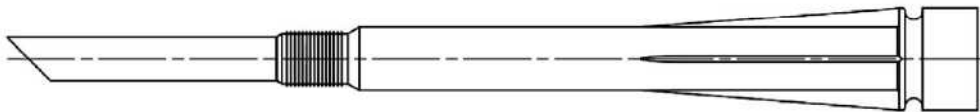

### Injection adapter and extension tube Ø 9 for static mixer FIS MR Plus; Injection adapter and extension tube Ø 9 or Ø 15 for static mixer FIS JMR

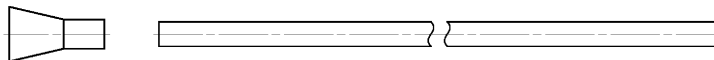

### Injection adapter

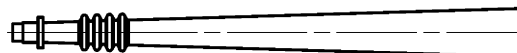

Figures not to scale

fischer Highbond-Anchor FHB / FHB dyn / FDA

#### Product description

Overview system components part 1  
cartridges / static mixer / accessories

**Annex A4**

Appendix 6 / 38



## Overview system components part 2

### fischer Highbond-Anchor FHB / FHB N (alternative designation)

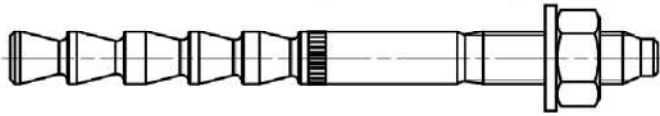

fischer anchor rod FHB-A / FHB-A N; Size: M10x60

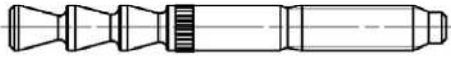

fischer anchor rod FHB-A / FHB-A N; Size: M12x80

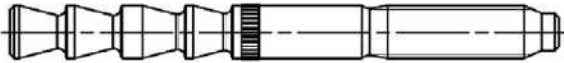

fischer anchor rod FHB-A / FHB-A N; Size: M12x100, M16x125, M20x170, M24x220

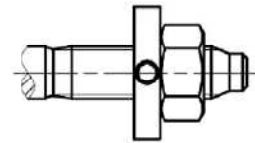
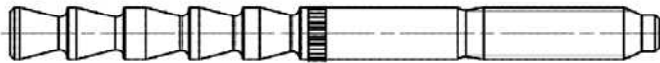

alternative version

### fischer Highbond-Anchor dynamic FHB dyn without shear force sleeve (in assembled condition)

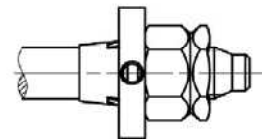
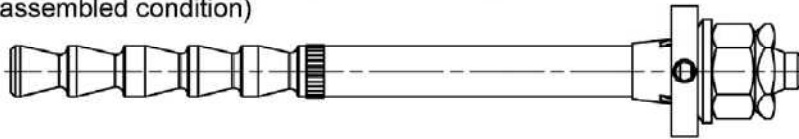

alternative version:  
hexagonal nut with  
spherical contact surface

### fischer Highbond-Anchor dynamic FHB dyn V with shear force sleeve (in assembled condition)

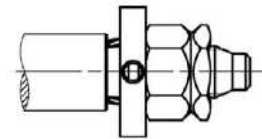
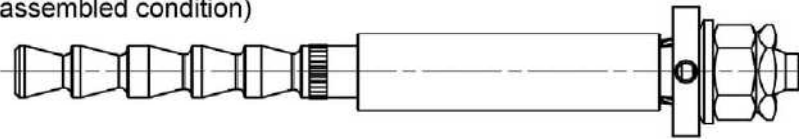

fischer anchor rod FHB-A dyn; Size: M12, M16, M20, M24

alternative

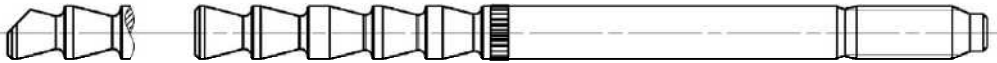

### fischer Dynamic-Anchor FDA

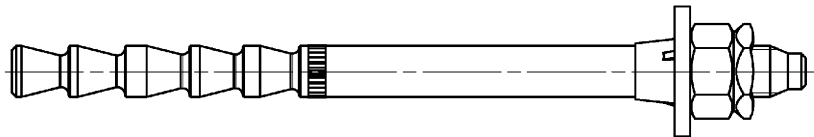

fischer anchor rod FDA-A; Size: M12, M16

alternative

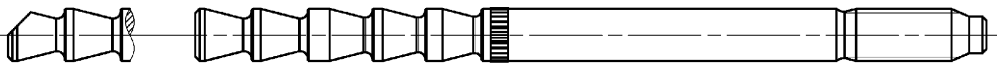

Figures not to scale

fischer Highbond-Anchor FHB / FHB dyn / FDA

#### Product description

Overview system components part 2  
Metal parts

**Annex A5**

Appendix 7 / 38

# Overview system components part 3

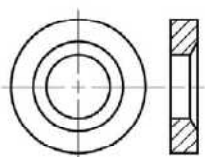
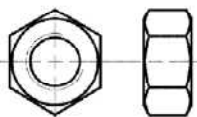
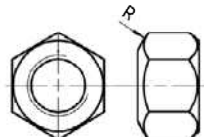
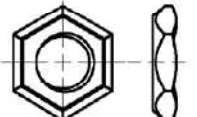
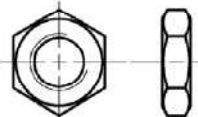
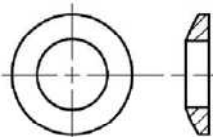
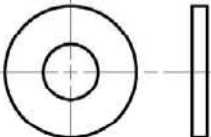
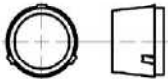
<p><b>conical washer</b> without drill hole</p> 	<p><b>fischer filling disc (various versions)</b></p> <table border="0"> <tr> <td data-bbox="375 90 717 382"> <p>radial</p>  </td> <td data-bbox="717 90 1059 382"> <p>angular</p>  </td> <td data-bbox="1059 90 1410 382"> <p>axial</p>  </td> </tr> </table>			<p>radial</p> 	<p>angular</p> 	<p>axial</p> 
<p>radial</p> 	<p>angular</p> 	<p>axial</p> 				
<p><b>hexagon nut</b></p> 	<p><b>hexagonal nut with spherical contact surface</b></p> 	<p><b>lock nut</b></p> 	<p><b>hexagon nut, flat</b></p> 			
<p><b>spherical washer</b></p> 	<p><b>washer</b></p> 	<p><b>centering sleeve</b></p>  <p><b>only push through installation; FHB dyn and FDA</b></p>				

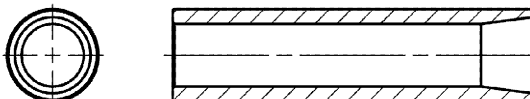
<p><b>shear force sleeve (only FHB dyn V)</b></p> 
--

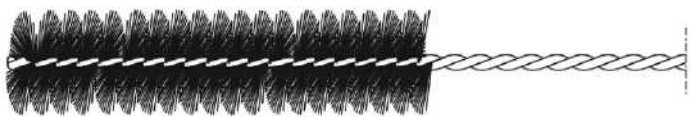
<p><b>cleaning brush BS</b></p> 
--

<p><b>blow-out pump ABP with cleaning nozzle or ABG</b></p> 
--

Figures not to scale

fischer Highbond-Anchor FHB / FHB dyn / FDA

**Product description**  
Overview system components part 3  
Metal parts / cleaning brush / blow-out pump

**Annex A6**

Appendix 8 / 38

**Table A7.1: Dimensions system components, FHB / FHB N**

Designation		FHB 10x60	FHB 12x80	FHB 12x100	FHB 16x125	FHB 20x170	FHB 24x220
Thread	[-]	M10	M12	M12	M16	M20	M24
Anchor rod	d	10	12	12	16,5	22	24,5
Conical washer / fischer filling disc	$\geq d_a$	26	30	30	38	46	54
	$t_s$	6	6	6	7	8	10

Anchor rod:

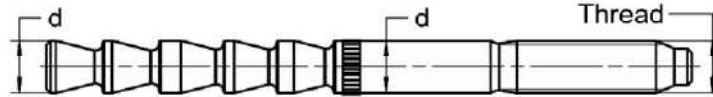

Conical washer /  
fischer filling disc:

(various versions see  
Annex A6)

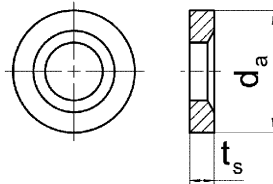

Figures not to scale

fischer Highbond-Anchor FHB / FHB dyn / FDA

**Product description**  
Dimensions system components, FHB / FHB N

**Annex A7**

Appendix 9 / 38

**Table A8.1: Dimensions system components, FHB dyn / FHB dyn V**

Designation	[-]	FHB dyn without shear force sleeve				FHB dyn V with shear force sleeve	
		FHB dyn 12x100	FHB dyn 16x125	FHB dyn 20x170	FHB dyn 24x220	FHB dyn 12x100 V	FHB dyn 16x125 V
Thread		M12	M16	M20	M24	M12	M16
Anchor rod	d	12	16,5	22	24,5	12	16,5
	L <sub>min</sub>	135	168	220	280	140	173
	L <sub>max</sub>	467	530	575	475	337	367
Centering sleeve	D <sub>z</sub>	11,8	16,3	21,8	24,3	11,8	16,3
	L <sub>z</sub>	11	13	15	15	11	13
Conical washer / fischer filling disc	≥ d <sub>a</sub>	30	38	46	54	30	38
	t <sub>s</sub>	6	7	8	10	6	7
Shear force sleeve	L <sub>Q,min</sub>	-	-	-	-	40	55
	L <sub>Q,max</sub>	-	-	-	-	230	245
	D <sub>Q</sub>	-	-	-	-	17,5	23,5

Anchor rod:

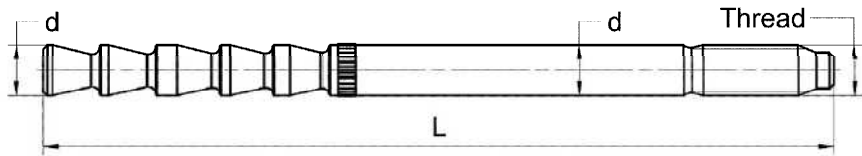

Centering sleeve:  
(only push through installation)

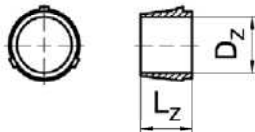

Conical washer / fischer filling disc:  
(various versions see Annex A6)

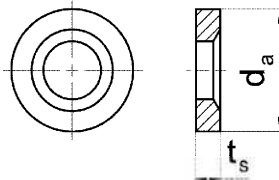

Shear force sleeve:  
(only FHB dyn V)

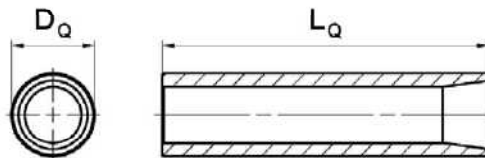

Figures not to scale

fischer Highbond-Anchor FHB / FHB dyn / FDA

**Product description**  
Dimensions system components, FHB dyn / FHB dyn V

**Annex A8**

Appendix 10 / 38

**Table A9.1: Dimensions system components, FDA**

Designation		FDA 12x100	FDA 16x125
Thread	[-]	M12	M16
Anchor rod	d	12	16,5
	L <sub>min</sub>	135	168
	L <sub>max</sub>	467	530
Centering sleeve	D <sub>z</sub>	11,8	16,3
	L <sub>z</sub>	11	13
Washer	≥ d <sub>a</sub>	30	40
	t <sub>s,min</sub>	3,5	4
	t <sub>s,max</sub>	7	8

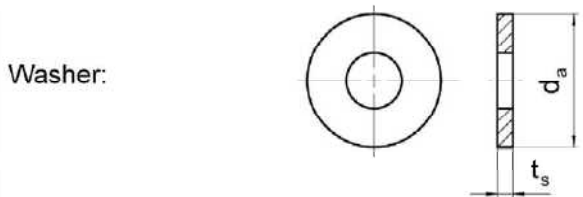
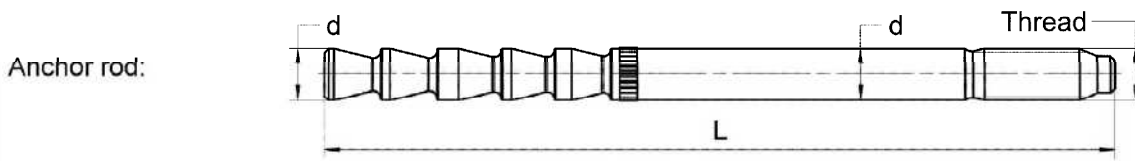

Figures not to scale

fischer Highbond-Anchor FHB / FHB dyn / FDA

**Product description**  
Dimensions system components, FDA

**Annex A9**

Appendix 11 / 38

**Table A10.1: Materials, FHB / FHB N zinc plated (zp; hdg)**

Part	Designation	Material		
1	Injection cartridge	Mortar, hardener, filler		
	Steel grade	Steel		
		zinc plated (zp)		hot dip galvanised (hdg)
		M10 to M16	M20 to M24	M10 to M24
2	fischer anchor rod FHB-A and FHB-A N	Property class 5.8 Property class 8.8 EN ISO 898-1:2013 zinc plated $\geq 5 \mu\text{m}$ ISO 4042:2022 $A_5 > 12\%$ fracture elongation coated	$f_{uk} = 550 \text{ N/mm}^2$ $f_{yk} = 440 \text{ N/mm}^2$ EN ISO 898-1:2013 zinc plated $\geq 5 \mu\text{m}$ ISO 4042:2022 $A_5 > 12\%$ fracture elongation coated	Property class 8.8 EN ISO 898-1:2013 hot dip galvanised $\geq 40 \mu\text{m}$ EN ISO 10684:2004+AC:2009 $A_5 > 12\%$ fracture elongation varnish layer coated (M16 to M24)
3	Washer ISO 7089:2000	zinc plated $\geq 5 \mu\text{m}$ ISO 4042:2022		hot dip galvanised $\geq 40 \mu\text{m}$ EN ISO 10684:2004+AC:2009
4	Conical washer or fischer filling disc similar to DIN 6319-G	zinc plated $\geq 5 \mu\text{m}$ ISO 4042:2022		hot dip galvanised $\geq 40 \mu\text{m}$ EN ISO 10684:2004+AC:2009
5	Hexagon nut	Property class 8 EN ISO 898-2:2012 zinc plated $\geq 5 \mu\text{m}$ ISO 4042:2022		Property class 8 EN ISO 898-2:2012 hot dip galvanised $\geq 40 \mu\text{m}$ EN ISO 10684:2004+AC:2009

fischer Highbond-Anchor FHB / FHB dyn / FDA

**Product description**  
Materials, FHB / FHB N zinc plated (zp; hdg)

**Annex A10**

Appendix 12 / 38

**Table A11.1: Materials, FHB / FHB N stainless steel**

Part	Designation	Material		
1	Injection cartridge	Mortar, hardener, filler		
	Steel grade	Stainless steel R		High corrosion resistant steel HCR
		acc. to EN 10088-1:2014 Corrosion resistance class CRC III acc. to EN 1993-1-4:2006+A1:2015		acc. to EN 10088-1:2014 Corrosion resistance class CRC V acc. to EN 1993-1-4:2006+A1:2015
		M10 to M16	M20 to M24	M10 to M24
2	fischer anchor rod FHB-A and FHB-A N	Property class 80 EN ISO 3506-1:2020 1.4401; 1.4404; 1.4578; 1.4571; 1.4439; 1.4362; 1.4062, 1.4662, 1.4462; EN 10088-1:2014 A <sub>5</sub> > 12% fracture elongation coated	Property class 70 with f <sub>yk</sub> = 560 N/mm <sup>2</sup> EN ISO 3506-1:2020 1.4401; 1.4404; 1.4578; 1.4571; 1.4439; 1.4362; 1.4062, 1.4662, 1.4462; EN 10088-1:2014 A <sub>5</sub> > 12% fracture elongation coated	Property class 70 with f <sub>yk</sub> = 560 N/mm <sup>2</sup> EN ISO 3506-1:2020 1.4565; 1.4529 EN 10088-1:2014 A <sub>5</sub> > 12% fracture elongation coated
3	Washer ISO 7089:2000	1.4401; 1.4404; 1.4578; 1.4571; 1.4439; 1.4362; EN 10088-1:2014		1.4565; 1.4529; EN 10088-1:2014
4	Conical washer or fischer filling disc similar to DIN 6319-G	1.4401; 1.4404; 1.4578; 1.4571; 1.4439; 1.4362; EN 10088-1:2014		1.4565; 1.4529; EN 10088-1:2014
5	Hexagon nut	Property class 70 or 80 EN ISO 3506-2:2020 1.4401; 1.4404; 1.4578; 1.4571; 1.4439; 1.4362; EN 10088-1:2014		Property class 70 or 80 EN ISO 3506-2:2020 1.4565; 1.4529; EN 10088-1:2014

fischer Highbond-Anchor FHB / FHB dyn / FDA

**Product description**  
Materials, FHB / FHB N stainless steel

**Annex A11**

Appendix 13 / 38

**Table A12.1: Materials, FHB dyn**

Part	Designation	Material	
1	Injection cartridge	Mortar, hardener, filler	
	Steel grade	Steel	High corrosion resistant steel HCR
		zinc plated (zp)	acc. to EN 10088-1:2014 Corrosion resistance class CRC V acc. to EN 1993-1-4:2006+A1:2015
		M12 to M24	M12 to M16
2	fischer anchor rod FHB-A dyn	Property class 8.8 EN ISO 898-1:2013 zinc plated $\geq 5 \mu\text{m}$ ISO 4042:2022 $A_5 > 12\%$ fracture elongation coated	Property class 70 with $f_{yk} = 560 \text{ N/mm}^2$ EN ISO 3506-1:2020 1.4529 EN 10088-1:2014 $A_5 > 12 \%$ fracture elongation coated
3	Centering sleeve	Plastic	
4	Conical washer or fischer filling disc similar to DIN 6319-G	zinc plated $\geq 5 \mu\text{m}$ ISO 4042:2022	1.4529 EN 10088-1:2014
5	Spherical washer	zinc plated $\geq 5 \mu\text{m}$ ISO 4042:2022	1.4529 EN 10088-1:2014
6a	Hexagon nut	Property class 8 EN ISO 898-2:2012 zinc plated $\geq 5 \mu\text{m}$ ISO 4042:2022	Property class 70 or 80 EN ISO 3506-2:2020 1.4529 EN 10088-1:2014
6b	hexagonal nut with spherical contact surface		
7a	Lock nut	zinc plated $\geq 5 \mu\text{m}$ ISO 4042:2022	1.4529 EN 10088-1:2014
7b	hexagon nut, flat		
8	Shear force sleeve	zinc plated $\geq 5 \mu\text{m}$ ISO 4042:2022	---

fischer Highbond-Anchor FHB / FHB dyn / FDA

**Product description**  
 Materials, FHB dyn

**Annex A12**

Appendix 14 / 38



**Table A13.1: Materials, FDA**

<b>Part</b>	<b>Designation</b>	<b>Material</b>
1	Injection cartridge	Mortar, hardener, filler
	Steel grade	Steel
		zinc plated (zp)
		M12 to M16
2	fischer anchor rod FDA-A	Property class 8.8 EN ISO 898-1:2013 zinc plated $\geq 5 \mu\text{m}$ ISO 4042:2022 $A_5 > 12 \%$ fracture elongation coated
3	Centering sleeve	Plastic
4	Washer	zinc plated $\geq 5 \mu\text{m}$ ISO 4042:2022
5	Hexagon nut	Property class 8 EN ISO 898-2:2012 zinc plated $\geq 5 \mu\text{m}$ ISO 4042:2022
6	Lock nut	zinc plated $\geq 5 \mu\text{m}$ ISO 4042:2022



fischer Highbond-Anchor FHB / FHB dyn / FDA

**Product description**  
Materials, FDA**Annex A13**

Appendix 15 / 38

# Specifications of intended use (part 1), FHB / FHB N

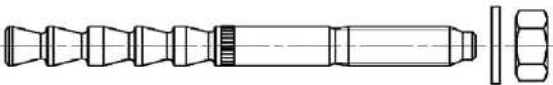
**Table B1.1:** Overview use and performance categories, FHB / FHB N

		<b>fischer Highbond-Anchor FHB / FHB N with FIS HB</b>	
			
Hammer drilling with standard drill bit		all sizes; Nominal drill bit diameter ( $d_0$ ) 12 mm to 28 mm	
Hammer drilling with hollow drill bit			
(fischer "FHD"; Heller "Duster Expert"; Bosch "Speed Clean"; Hilti "TE-CD, TE-YD"; DreBo „D-Plus“; DreBo „D-Max“)			
Static and quasi static loading, in concrete without fibers	uncracked concrete	all sizes; M10 to M24	Tables: C1.1 C2.1 C3.1
	cracked concrete		
Static and quasi static loading, in concrete with fibers	uncracked concrete	sizes: M12x100 M16x125	Tables: C1.1 C2.1 C3.2
	cracked concrete		
Use category	I1 dry or wet concrete	all sizes; M10 to M24	
	I2 water filled hole	all sizes; M10 to M24	
Installation direction		D3 Downwards, horizontal and upwards (overhead) installation	
Installation method		pre-positioned or push through installation	
Installation temperature		FIS HB: $T_{i,min} = -5\text{ °C}$ to $T_{i,max} = +40\text{ °C}$ for the standard variation of temperature after installation	
In-service temperature	Temperature range I:	-40 °C to +40 °C	(max. short term temperature +40 °C; max. long term temperature +24 °C)
	Temperature range II:	-40 °C to +80 °C	(max. short term temperature +80 °C; max. long term temperature +50 °C)

fischer Highbond-Anchor FHB / FHB dyn / FDA



**Intended use**  
Specifications (part 1), FHB / FHB N

**Annex B1**

Appendix 16 / 38

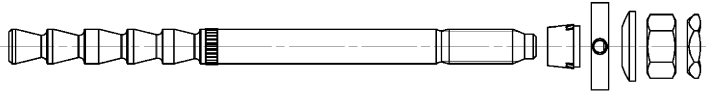
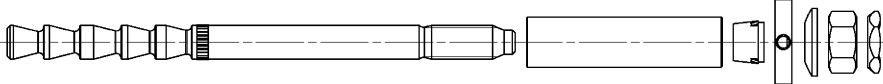

# Specifications of intended use (part 2), FHB dyn

**Table B2.1:** Overview use and performance categories, FHB dyn

		fischer Highbond-Anchor dynamic FHB dyn with FIS HB			
		<b>FHB-A dyn, without shear force sleeve</b> (picture with centering sleeve; use only for push through installation)			
					
		<b>FHB-A dyn V, with shear force sleeve</b>			
					
		FHB dyn		FHB dyn V	
Hammer drilling with standard drill bit		all sizes; Nominal drill bit diameter (d <sub>0</sub> ) 14 mm to 28 mm		all sizes; Nominal drill bit diameter (d <sub>0</sub> ) 14 mm and 18 mm  Nominal drill bit diameter (d <sub>1</sub> ) 20 mm and 28 mm	
Hammer drilling with hollow drill bit					
(fischer "FHD", Heller "Duster Expert"; Bosch "Speed Clean"; Hilti "TE-CD, TE-YD"; DreBo „D-Plus“; DreBo „D-Max“)					
Static and quasi static loading, in concrete without fibers	uncracked concrete <hr/> cracked concrete	all sizes; M12 to M24	Tables: C1.1 C2.1 C3.1	all sizes; M12 and M16	Tables: C1.1 C2.1 C3.1
Static and quasi static loading, in concrete with fibers	uncracked concrete <hr/> cracked concrete	sizes: M12x100 M16x125	Tables: C1.1 C2.1 C3.2	sizes: M12x100 M16x125	Tables: C1.1 C2.1 C3.2
Use category	11 dry or wet concrete	all sizes; M12 to M24		all sizes; M12 and M16	
	12 water filled hole	all sizes; M12 to M24		all sizes; M12 and M16	
Installation direction		D3 Downwards, horizontal and upwards (overhead) installation			
Installation method		pre-positioned or push through installation		push through installation	
Installation temperature		FIS HB: T <sub>i,min</sub> = -5 °C to T <sub>i,max</sub> = +40 °C for the standard variation of temperature after installation			
In-service temperature	Temperature range I:	-40 °C to +40 °C	(max. short term temperature +40 °C; max. long term temperature +24 °C)		
	Temperature range II:	-40 °C to +80 °C	(max. short term temperature +80 °C; max. long term temperature +50 °C)		
fischer Highbond-Anchor FHB / FHB dyn / FDA		<b>Annex B2</b> Appendix 17 / 38			
Intended use Specifications (part 2), FHB dyn					

# Specifications of intended use (part 3), FDA

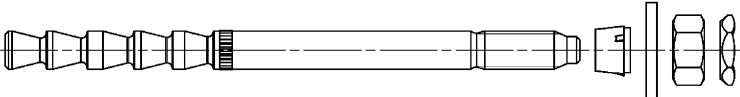
**Table B3.1:** Overview use and performance categories, FDA

		<b>fischer Dynamic-Anchor FDA with FIS HB</b>	
			
Hammer drilling with standard drill bit		all sizes; Nominal drill bit diameter ( $d_0$ ) 14 mm and 18 mm	
Hammer drilling with hollow drill bit			
(fischer "FHD"; Heller "Duster Expert"; Bosch "Speed Clean"; Hilti "TE-CD, TE-YD"; DreBo „D-Plus“; DreBo „D-Max“)			
Static and quasi static loading, in concrete without fibers	uncracked concrete	all sizes; M12 and M16	Tables: C1.1 C2.1 C3.1
	cracked concrete		
Static and quasi static loading, in concrete with fibers	uncracked concrete	sizes: M12x100 M16x125	Tables: C1.1 C2.1 C3.2
	cracked concrete		
Use category	I1 dry or wet concrete	all sizes; M12 and M16	
	I2 water filled hole	all sizes; M12 and M16	
Installation direction		D3 Downwards, horizontal and upwards (overhead) installation	
Installation method		push through installation	
Installation temperature		FIS HB: $T_{i,min} = -5\text{ °C}$ to $T_{i,max} = +40\text{ °C}$ for the standard variation of temperature after installation	
In-service temperature	Temperature range I:	-40 °C to +40 °C	(max. short term temperature +40 °C; max. long term temperature +24 °C)
	Temperature range II:	-40 °C to +80 °C	(max. short term temperature +80 °C; max. long term temperature +50 °C)

fischer Highbond-Anchor FHB / FHB dyn / FDA

**Intended use**  
Specifications (part 3), FDA

**Annex B3**

Appendix 18 / 38

## Specifications of intended use (part 4)

### Base materials:

- Compacted reinforced or unreinforced normal weight concrete of strength classes C20/25 to C50/60 according to EN 206:2013+A2:2021.
- For steel fibre reinforced concrete according to EN 206:2013+A2:2021 with steel fibers in accordance to EN 14889-1:2006, clause 5, group I. The maximum content of steel fibres is 80 kg/m<sup>3</sup>.

### Use conditions (Environmental conditions):

- Fastener intended for use in structures subject to dry internal conditions (all materials).
- For all other conditions according to EN 1993-1-4: 2006 + A1:2015 corresponding to corrosion resistance classes to Annex A11 table A11.1 (FHB / FHB N) or Annex A12 table A12.1 (FHB dyn).

### Design:

- Fastenings have to be designed by a responsible engineer with experience of concrete anchor design.
- Verifiable calculation notes and drawings are to be prepared taking account of the loads to be anchored. The position of the anchor is indicated on the design drawings (e. g. position of the anchor relative to reinforcement or to supports, etc.)
- Fastenings are designed in accordance with:
  - EN 1992-4:2018 and
  - EOTA Technical Report TR 055, Edition February 2018.
- Fastenings in steel fibre reinforced concrete can be designed according to EN 1992-4:2018. The performance for normal weight concrete of strength classes C20/25 to C50/60 without fibres applies.

### Installation:

- Fastener installation is to be carried out by appropriately qualified personnel and under the supervision of the person responsible for technical matters of the site.
- Overhead installation is allowed. (necessary equipment see installation instruction).

fischer Highbond-Anchor FHB / FHB dyn / FDA

**Intended use**  
Specifications (part 4)

**Annex B4**

Appendix 19 / 38

**Table B5.1: Installation parameters for fischer Highbond-Anchor FHB / FHB N**

Designation		FHB 10x60	FHB 12x80	FHB 12x100	FHB 16x125	FHB 20x170	FHB 24x220		
Thread	[-]	M10	M12	M12	M16	M20	M24		
Nominal drill hole diameter	$d_0$	12	14	14	18	24	28		
Drill hole depth	$h_0$	$h_{ef} + 5$							
Effective embedment depth	$h_{ef}$	60	80	100	125	170	220		
Minimum thickness of concrete member	$h_{min}$	120	160	130	160	220	440		
Minimum spacing	$s_{min}$	60	80	100	100	100	100		
Minimum edge distance	$c_{min}$			200	100	200	100	80	180
Thickness of concrete member	$h$	$\geq 120$	$\geq 160$	$\geq 130$	$\geq 200$	$\geq 160$	$\geq 250$	$\geq 220$	$\geq 440$
$h_{min} \leq h \leq 2h_{ef}$ : $s_1 \geq s_{min} = 100$ mm $c_1 \geq c_{min} = 100$ mm		[mm]		[[ $(3 \cdot c_1 + s_1) \cdot h$ ] $\geq 88000$					
Calculation $c_{req}$ : $s_1$ and $h$ available		-		$c_{req} \geq (88000/h - s_1) / 3$				-	
Calculation $s_{req}$ : $c_1$ and $h$ available		-		$s_{req} \geq 88000/h - 3 \cdot c_1$					
Diameter of clearance hole of the fixture	pre-positioned installation	$d_f$	12	14	14	18	22	26	
	push through installation	$d_f$	14	16	16	20	26	30	
Installation torque	$T_{inst}$	[Nm]	20	40	40	60	100	120	

**fischer anchor rod FHB-A / FHB-A N**

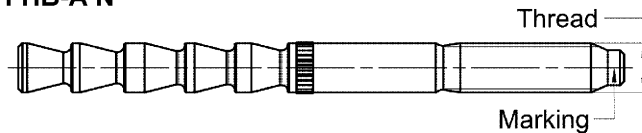

**Marking fischer anchor rod:**

work symbol, thread diameter, embedment depth e.g.: 16 x 125

For anchor rod property class 5.8 additional "5.8"

For stainless steel additional "R" and for high corrosion resistant steel additional "HCR".

**Installation conditions:**

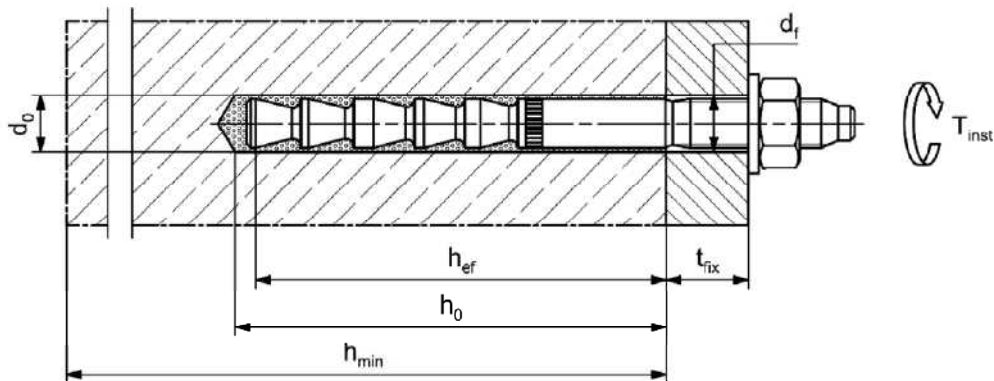

Figures not to scale

fischer Highbond-Anchor FHB / FHB dyn / FDA

**Intended use**  
Installation parameters fischer Highbond-Anchor FHB / FHB N

**Annex B5**

Appendix 20 / 38

**Table B6.1: Installation parameters for fischer Highbond-Anchor dynamic without shear force sleeve FHB dyn**

Designation		FHB dyn 12x100	FHB dyn 16x125	FHB dyn 20x170	FHB dyn 24x220
Thread	[-]	M12	M16	M20	M24
Nominal drill hole diameter	$d_0$	14	18	24	28
Drill hole depth	$h_{0,min}$	$h_{ef} + 5$			
Effective embedment depth	$h_{ef,min}$	100	125	170	220
	$h_{ef,max}$	235	290	330	-
Minimum thickness of concrete member	$h_{min}$	$h_{ef} + 30$	$h_{ef} + 2d_0$ (160) <sup>1)</sup>	$h_{ef} + 2d_0$	440
Minimum spacing	$s_{min}$	100	100	80	180
Minimum edge distance	$c_{min}$	200	100	80	180
Thickness of concrete member	$h$	$\geq 130$	$\geq 200$	$\geq 160$	$\geq 250$
$h_{min} \leq h \leq 2 h_{ef,min}$ : $s_1 \geq s_{min} = 100$ mm $c_1 \geq c_{min} = 100$ mm		$[(3 \cdot c_1 + s_1) \cdot h] \geq 88000$			
Calculation $c_{req}$ : ( $s_1$ and $h$ available)		$c_{req} \geq (88000/h - s_1) / 3$			
Calculation $s_{req}$ : ( $c_1$ and $h$ available)		$s_{req} \geq 88000/h - 3 \cdot c_1$			
Diameter of the clearance hole of the fixture	$d_f$	15	19	25	29
Thickness of fixture	$t_{fix,min}$	8	10	12	14
	$t_{fix,max}$	200			
Minimum projection length	$h_{p,min}$	$30 + t_{fix}$	$35 + t_{fix}$	$40 + t_{fix}$	$50 + t_{fix}$
Installation torque	$T_{inst}$ [Nm]	40	60	100	120

<sup>1)</sup> Only valid for  $h_{ef} = 125$  mm

**fischer anchor rod FHB-A dyn**

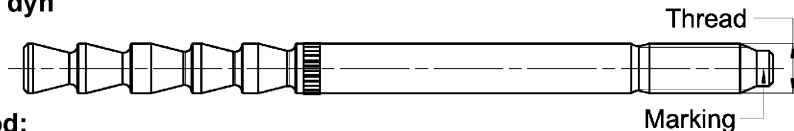

**Marking fischer anchor rod:**

work symbol, thread diameter, embedment depth, intended use e.g.:  $\varnothing 16 \times 125$  dyn  
For high corrosion resistant steel additional "HCR".

**Installation conditions:** (picture without centering sleeve; pre-positioned installation)

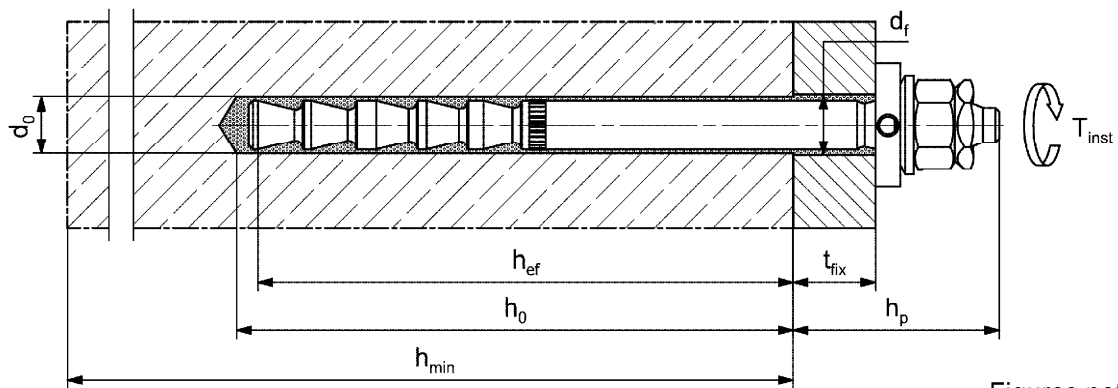

Figures not to scale

fischer Highbond-Anchor FHB / FHB dyn / FDA

**Intended use**  
Installation parameters fischer Highbond-Anchor dynamic FHB dyn  
(without shear force sleeve)

**Annex B6**

Appendix 21 / 38

**Table B7.1: Installation parameters for fischer Highbond-Anchor dynamic with shear force sleeve FHB dyn V**

Designation		FHB dyn 12x100 V		FHB dyn 16x125 V	
Thread	[-]	M12		M16	
Nominal drill hole diameter	$d_0$	14		18	
Drill hole depth	$h_{0,min}$	110		135	
Nominal drill hole diameter	$d_1$	20		28	
Drill hole depth	$h_{1,min}$	35		50	
Effective embedment depth	$h_{ef}$	105		130	
Minimum thickness of concrete member	$h_{min}$	130		160	
Minimum spacing	$s_{min}$	100	100	100	100
Minimum edge distance	$c_{min}$	200	100	200	100
Thickness of concrete member	$h$	$\geq 130$	$\geq 200$	$\geq 160$	$\geq 250$
$h_{min} \leq h \leq 2h_{ef}$ : $s_1 \geq s_{min} = 100 \text{ mm}$ $c_1 \geq c_{min} = 100 \text{ mm}$	[mm]	$[(3 \cdot c_1 + s_1) \cdot h] \geq 88000$			
Calculation $c_{req}$ : $s_1$ and $h$ available		$c_{req} \geq (88000/h - s_1) / 3$			
Calculation $s_{req}$ : $c_1$ and $h$ available		$s_{req} \geq 88000/h - 3 \cdot c_1$			
Diameter of the clearance hole of the fixture	$d_f$	21		29	
Thickness of fixture	$t_{fix,min}$	8		10	
	$t_{fix,max}$	200			
Installation torque	$T_{inst}$	[Nm]	40	60	

**fischer anchor rod FHB-A dyn V** (picture without shear force sleeve)

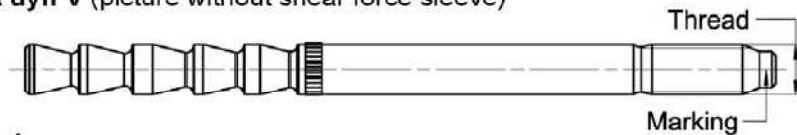

**Marking fischer anchor rod:**

work symbol, thread diameter, embedment depth, intended use e.g.:  $\oslash$  16 x 125 dyn V

**Installation conditions:**

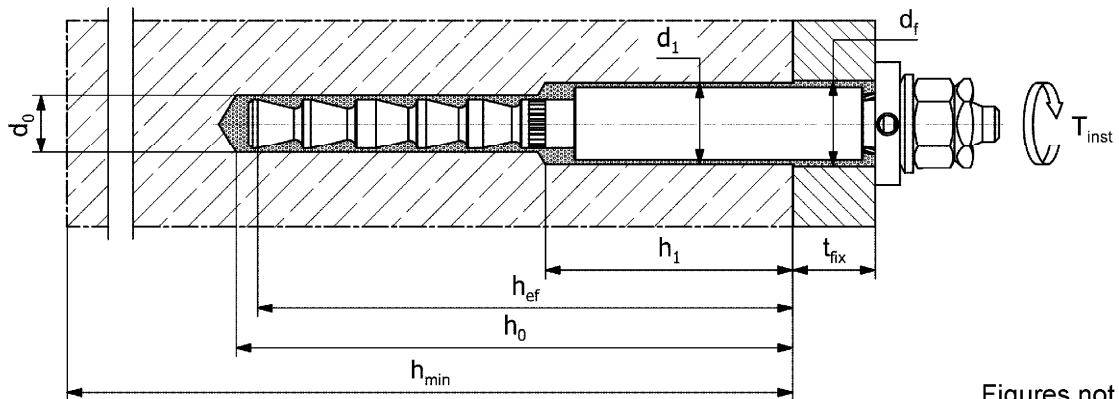

fischer Highbond-Anchor FHB / FHB dyn / FDA

**Intended use**

Installation parameters fischer Highbond-Anchor dynamic FHB dyn V (with shear force sleeve)

**Annex B7**

Appendix 22 / 38

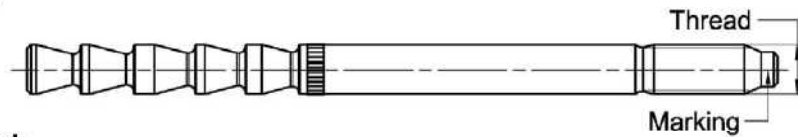

**Table B8.1: Installation parameters for fischer Dynamic-Anchor FDA**

Designation		FDA 12x100		FDA 16x125	
Thread	[-]	M12		M16	
Nominal drill hole diameter	$d_0$	14		18	
Drill hole depth	$h_{0,min}$	$h_{ef} + 5$			
Effective embedment depth	$h_{ef,min}$	100		125	
	$h_{ef,max}$	235		290	
Minimum thickness of concrete member	$h_{min}$	$h_{ef} + 30$		$h_{ef} + 2d_0$ (160) <sup>1)</sup>	
Minimum spacing	$s_{min}$	100	100	100	100
Minimum edge distance	$c_{min}$	200	100	200	100
Thickness of concrete member	$h$	$\geq 130$	$\geq 200$	$\geq 160$	$\geq 250$
$h_{min} \leq h \leq 2h_{ef,min}$ : $s_1 \geq s_{min} = 100$ mm $c_1 \geq c_{min} = 100$ mm	[mm]	$[(3 \cdot c_1 + s_1) \cdot h] \geq 88000$			
Calculation $c_{req}$ : $s_1$ and $h$ available		$c_{req} \geq (88000/h - s_1) / 3$			
Calculation $s_{req}$ : $c_1$ and $h$ available		$s_{req} \geq 88000/h - 3 \cdot c_1$			
Diameter of the clearance hole of the fixture	$d_f$	15		19	
Thickness of fixture	$t_{fix,min}$	12		16	
	$t_{fix,max}$	200			
Installation torque	$T_{inst}$	[Nm]	40	60	

<sup>1)</sup> Only valid for  $h_{ef} = 125$  mm

**fischer anchor rod FDA-A**



**Marking fischer anchor rod:**

work symbol, thread diameter, embedment depth, intended use e.g.: 16 x 125 dyn

**Installation conditions:**

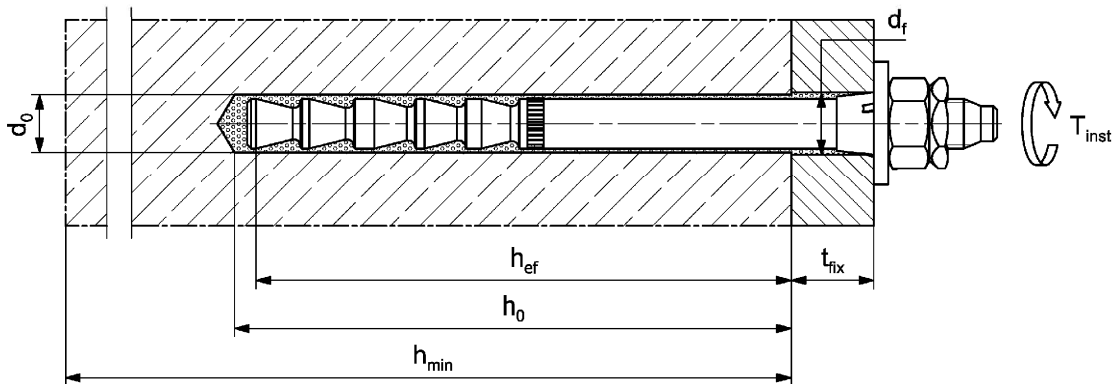

Figures not to scale

fischer Highbond-Anchor FHB / FHB dyn / FDA

**Intended use**  
Installation parameters fischer Dynamic-Anchor FDA

**Annex B8**

Appendix 23 / 38

**Table B9.1: Parameters of the cleaning brush BS (steel brush with steel bristles)**

The size of the cleaning brush refers to the drill hole diameter

Nominal drill hole diameter	$d_0$	[mm]	12	14	18	24	28
Steel brush diameter	$d_b$		14	16	20	26	30

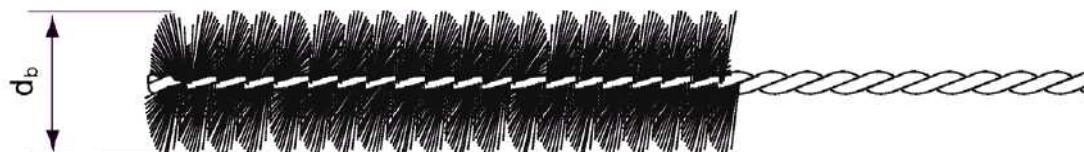

**Table B9.2: Maximum processing time of the mortar FIS HB and minimum curing time (During the curing time of the mortar the concrete temperature may not fall below the listed minimum temperature)**

Temperature at anchoring base [°C]	Maximum processing time $t_{work}$	Minimum curing time $t_{cure}$ <sup>1)</sup>
-5 to 0 <sup>2)</sup>	15 min	6 h
> 0 to 5 <sup>2)</sup>	15 min	3 h
> 5 to 10	15 min	90 min
> 10 to 20	6 min	35 min
> 20 to 30	4 min	20 min
> 30 to 40	2 min	12 min

<sup>1)</sup> In wet concrete or water filled holes the curing time must be doubled.

<sup>2)</sup> Minimal cartridge temperature +5 °C.

Figures not to scale

fischer Highbond-Anchor FHB / FHB dyn / FDA

**Intended use**  
Parameters of the cleaning brush (steel brush);  
Processing time and curing time

**Annex B9**

Appendix 24 / 38

## Overview installation instructions

	Anchor type			
	FHB / FHB N	FHB dyn	FHB dyn V	FDA
<b>Drilling and cleaning</b> hammer drilling with standard drill bit	Annex B11 Step 1a to 4a	Annex B11 Step 1a to 4a	Annex B12 Step 1c to 4c	Annex B11 Step 1a to 4a
<b>Drilling and cleaning</b> hammer drilling with hollow drill bit	Annex B11 Step 1b to 2b	Annex B11 Step 1b to 2b	Annex B12 Step 1d to 2d	Annex B11 Step 1b to 2b
<b>Preparing the cartridge</b>	Annex B13 Step 5a to 7a			
<b>Pre-positioned installation</b>	Annex B14 Step 8a to 12a	Annex B16 Step 8c to 12c	-	-
<b>Push through installation</b>	Annex B15 Step 8b to 11b	Annex B17 Step 8d to 11d	Annex B18 Step 8e to 11e	Annex B19 Step 8f to 11f





fischer Highbond-Anchor FHB / FHB dyn / FDA

**Intended use**  
Overview installation instructions

**Annex B10**  
Appendix 25 / 38

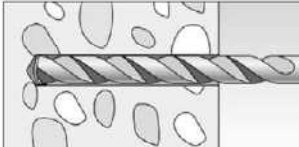
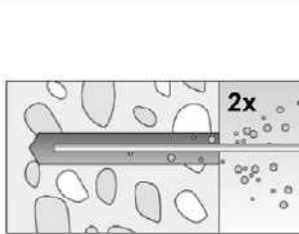
# Installation instructions part 1; Drilling and cleaning FHB, FHB N, FHB dyn and FDA

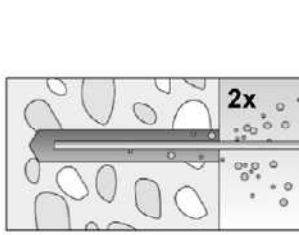
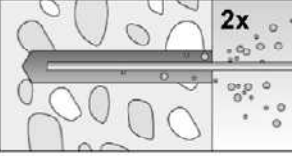
## Drilling and cleaning the drill hole (hammer drilling with standard drill bit)

1a		<p>Drill the hole. Nominal drill hole diameter <math>d_0</math> and drill hole depth <math>h_0</math> see tables: FHB / FHB N → <b>Table B5.1</b> FHB dyn → <b>Table B6.1</b> FDA → <b>Table B8.1</b></p>
2a		<p>Clean the drill hole. Blow out the drill hole twice</p> <p>For drill hole diameter <math>d_0 &lt; 24</math> mm and drill hole depth <math>h_0 &lt; 10d</math> blow out the hole by hand or oil-free compressed air (<math>\geq 6</math> bar).</p> <p>For drill hole diameter <math>d_0 \geq 24</math> mm or drill hole depth <math>h_0 \geq 10d</math> blow out the hole with oil-free compressed air (<math>\geq 6</math> bar).</p> <p>Use a cleaning nozzle.</p> 
3a		<p>Brush the drill hole twice with steel brush. Corresponding brushes see <b>Table B9.1</b></p>
4a		<p>Clean the drill hole. Blow out the drill hole twice</p> <p>For drill hole diameter <math>d_0 &lt; 24</math> mm and drill hole depth <math>h_0 &lt; 10d</math> blow out the hole by hand or oil-free compressed air (<math>\geq 6</math> bar).</p> <p>For drill hole diameter <math>d_0 \geq 24</math> mm or drill hole depth <math>h_0 \geq 10d</math> blow out the hole with oil-free compressed air (<math>\geq 6</math> bar).</p> <p>Use a cleaning nozzle.</p> 

Go to step 5a (Annex B13)

## Drilling and cleaning the drill hole (hammer drilling with hollow drill bit)

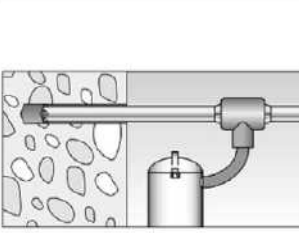
1b		<p>Check a suitable hollow drill (see <b>Table B1.1, B2.1 resp. B3.1</b>) for correct operation of the dust extraction</p>
2b		<p>Use a suitable dust extraction system, e.g. fischer FVC 35 M or a comparable dust extraction system with equivalent performance data.</p> <p>Drill the hole with hollow drill bit. The dust extraction system has to extract the drill dust nonstop during the drilling process and must be adjusted to maximum power.</p> <p>Nominal drill hole diameter <math>d_0</math> and drill hole depth <math>h_0</math> see tables: FHB / FHB N → <b>Table B5.1</b> FHB dyn → <b>Table B6.1</b> FDA → <b>Table B8.1</b></p>

Go to step 5a (Annex B13)

fischer Highbond-Anchor FHB / FHB dyn / FDA





**Intended use**  
Installation instructions part 1  
Drilling and cleaning the drill hole FHB, FHB N, FHB dyn and FDA

**Annex B11**

Appendix 26 / 38

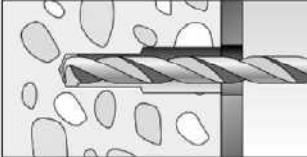
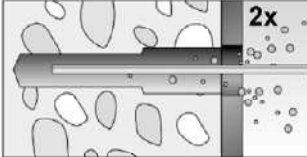
## Installation instructions part 2; Drilling and cleaning FHB dyn V

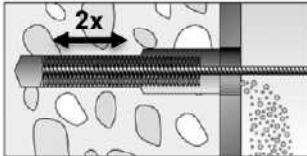
### Drilling and cleaning the hole (hammer drilling with standard drill bit)

1c		<p>Drill hole 1 of the stepped borehole. Nominal drill hole diameter <math>d_1</math> and drill hole depth <math>h_1</math> see <b>Table B7.1</b></p>
		<p>Drill hole 2 of the stepped borehole. Nominal drill hole diameter <math>d_0</math> and drill hole depth <math>h_0</math> see <b>Table B7.1</b></p>
2c		<p>Clean the drill hole. Blow out the drill hole twice by hand or oil-free compressed air (<math>\geq 6</math> bar).</p> 
3c		<p>Brush the drill hole 2 of the borehole twice with a steel brush. Corresponding brushes see <b>Table B9.1</b></p>
4c		<p>Clean the drill hole. Blow out the drill hole twice by hand or oil-free compressed air (<math>\geq 6</math> bar).</p> 

Go to step 5a (Annex B13)

### Drilling and cleaning the hole (hammer drilling with hollow drill bit)

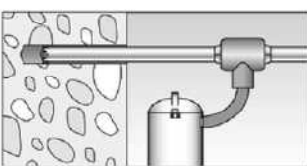
1d		<p>Check a suitable hollow drill (see <b>Table B2.1</b>) for correct operation of the dust extraction.</p>
2d		<p>Use a suitable dust extraction system, e.g. fischer FVC 35 M or a comparable dust extraction system with equivalent performance data.</p> <p>Drill the hole with hollow drill bit. The dust extraction system has to extract the drill dust nonstop during the drilling process and must be adjusted to maximum power.</p> <p>First drill hole 1 of the stepped borehole with nominal drill hole diameter <math>d_1</math> and drill hole depth <math>h_1</math> (see <b>Table B7.1</b>).</p> <p>Then drill hole 2 of the stepped borehole with nominal drill hole diameter <math>d_0</math> and drill hole depth <math>h_0</math> (see <b>Table B7.1</b>).</p>

Go to step 5a (Annex B13)

fischer Highbond-Anchor FHB / FHB dyn / FDA





**Intended use**  
Installation instructions part 2  
Drilling and cleaning the drill hole FHB dyn V

**Annex B12**

Appendix 27 / 38

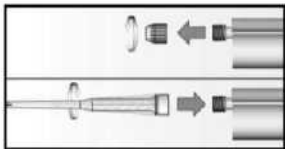
## Installation instructions part 3; injection mortar system FIS HB

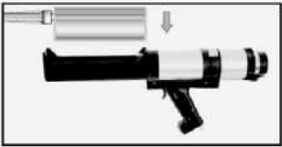
### Preparing the cartridge

5a		Remove the sealing cap Screw on the static mixer (the spiral in the static mixer must be clearly visible)	
6a			Place the cartridge into the dispenser
7a			Extrude approximately 10 cm of material out until the resin is evenly grey in colour. Do not use mortar that is not uniformly grey

Go to step:

- 8a: FHB / FHB N - Pre-positioned installation see Annex B14
- 8b: FHB / FHB N - Push through installation see Annex B15
- 8c: FHB dyn - Pre-positioned installation see Annex B16
- 8d: FHB dyn - Push through installation see Annex B17
- 8e: FHB dyn V - Push through installation see Annex B18
- 8f: FDA - Push through installation see Annex B19

fischer Highbond-Anchor FHB / FHB dyn / FDA



**Intended use**  
Installation instructions part 3  
Preparing the cartridge

**Annex B13**

Appendix 28 / 38

## Installation instructions part 4; Pre-positioned installation FHB / FHB N

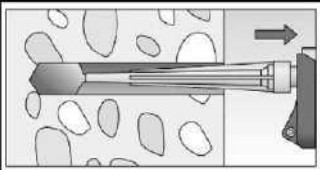
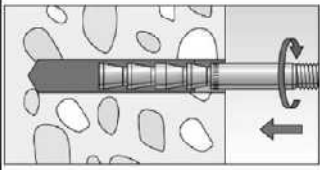
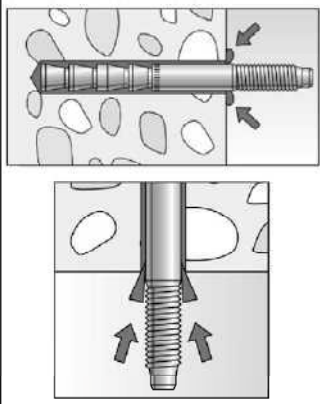
### Pre-positioned installation FHB / FHB N

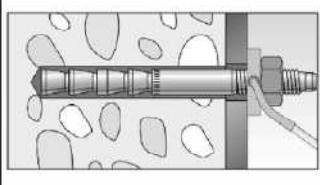
8a		<p>Fill approximately 2/3 of the drill hole with mortar. Always begin from the bottom of the hole and avoid bubbles. For drill hole depth <math>h_0 \geq 150</math> mm use an extension tube. For overhead installation or deep holes (<math>h_0 &gt; 250</math> mm) use an injection adapter.</p>
		<p>Push the anchor rod down to the bottom of the hole, turning it slightly while doing so. Only use clean and oil-free metal parts.</p>
9a		<p>After inserting the anchor rod, excess mortar must be emerged around the anchor element. If not, pull out the anchor rod immediately and reinject mortar.</p> <p>For overhead installations support the anchor rod with wedges. (e.g. fischer centering wedges).</p>
10a		<p>Wait for the specified curing time <math>t_{cure}</math> see <b>Table B9.2</b>.</p>
11a		<p>Attach the fixture and install the washer and hexagon nut. Ensure the correct position of the metal parts. Tighten the hexagon nut with installation torque <math>T_{inst}</math> (see <b>Table B5.1</b>).</p>
12a Option		<p>The gap between metal parts and fixture (annular gap) may be filled with mortar (FIS HB) via the fischer filling disc. <b>ATTENTION:</b> Using fischer filling disc reduces <math>t_{fix}</math> (usable length of the anchor)</p>

fischer Highbond-Anchor FHB / FHB dyn / FDA

**Intended use**  
Installation instructions part 4  
Pre-positioned installation FHB / FHB N



**Annex B14**

Appendix 29 / 38

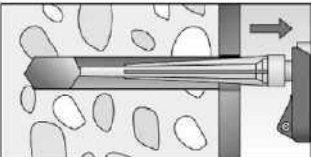
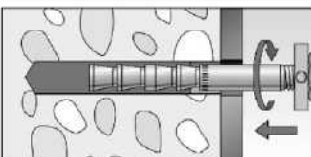

## Installation instructions part 5; Push through installation FHB / FHB N

### Push through installation FHB / FHB N

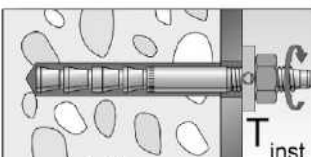
8b		<p>Fill approximately 2/3 of the drill hole incl. fixture with mortar. Always begin from the bottom of the hole and avoid bubbles. For drill hole depth <math>h_0 \geq 150</math> mm use an extension tube. For overhead installation or deep holes (<math>h_0 &gt; 250</math> mm) use an injection adapter.</p>
9b	 	<p>Push the pre-assembled fischer anchor rod (with washer and hexagon nut) into the drill hole until the fischer filling disc is in full contact with the surface, turning it slightly while doing so. Ensure the correct position of the metal parts. Only use clean and oil-free metal parts.</p> <p>After inserting the pre-assembled anchor rod, excess mortar has to emerge under the washer. If not, pull out the assembled anchor rod immediately and reinject mortar.</p>
10b		<p>Wait for the specified curing time <math>t_{cure}</math> see <b>Table B9.2</b>.</p>
11b		<p>Tighten the hexagon nut with installation torque <math>T_{inst}</math> (see <b>Table B5.1</b>).</p>

fischer Highbond-Anchor FHB / FHB dyn / FDA





**Intended use**  
Installation instructions part 5  
Push through installation FHB / FHB N

**Annex B15**  
Appendix 30 / 38

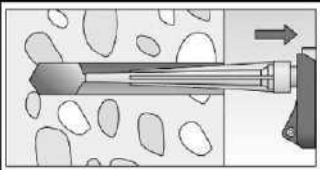
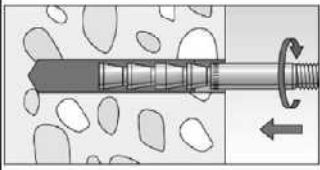

## Installation instructions part 6; Pre-positioned installation FHB dyn

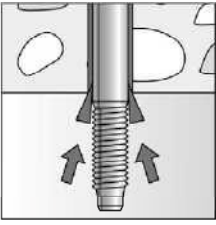
### Pre-positioned installation FHB dyn

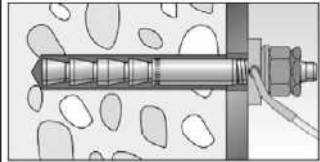
8c		<p>Fill approximately 2/3 of the drill hole with mortar. Always begin from the bottom of the hole and avoid bubbles. For drill hole depth <math>h_0 \geq 150</math> mm use an extension tube. For overhead installation or deep holes (<math>h_0 &gt; 250</math> mm) use an injection adapter.</p>
		<p>Push the anchor rod down to the bottom of the hole, turning it slightly while doing so. Observe projection length <math>h_p</math> (see <b>Table B6.1</b>) Only use clean and oil-free metal parts.</p>
9c	 	<p>After inserting the anchor rod, excess mortar must be emerged around the anchor element. If not, pull out the anchor rod immediately and reinject mortar.</p> <p>For overhead installations support the anchor rod with wedges. (e.g. fischer centering wedges)</p>
10c		<p>Wait for the specified curing time <math>t_{cure}</math> see <b>Table B9.2</b></p>
11c		<p>Attach the fixture and install the fischer filling disc, the spherical washer and nuts (<b>without centering sleeve</b>). Ensure the correct position of the metal parts. Tighten the hexagon nut with installation torque <math>T_{inst}</math> (see <b>Table B6.1</b>). Tighten lock nut manually, then use wrench to give another quarter or half turn. In the high corrosion resistant steel version, the lock nut is a thin nut. Tighten it with a torque of <math>\frac{1}{4} T_{inst}</math>.</p>
12c		<p>The gap between metal parts and fixture (annular gap) has to be filled with mortar (FIS HB) via the fischer filling disc. This installation step can be omitted for anchors with pure tension loading.</p>

fischer Highbond-Anchor FHB / FHB dyn / FDA





**Intended use**  
Installation instructions part 6  
Pre-positioned installation FHB dyn

**Annex B16**

Appendix 31 / 38

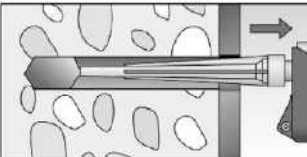
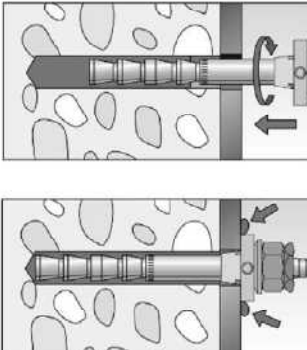
## Installation instructions part 7; Push through installation FHB dyn

### Push through installation FHB dyn

8d		<p>Fill approximately 2/3 of the drill hole incl. fixture with mortar. Always begin from the bottom of the hole and avoid bubbles. For drill hole depth <math>h_0 \geq 150</math> mm use an extension tube. For overhead installation or deep holes (<math>h_0 &gt; 250</math> mm) use an injection-adapter.</p>
9d	 	<p>Push the pre-assembled fischer anchor rod (with centering sleeve, fischer filling disc, spherical washer, hexagon nut and lock nut) into the drill hole until the fischer filling disc is in full contact with the surface, turning it slightly while doing so. Ensure the correct position of the metal parts and the centering sleeve. Only use clean and oil-free metal parts.</p> <p>After inserting the pre-assembled anchor rod, excess mortar must be emerged around the fischer filling disc (minimum on one point). If not, pull out the assembled anchor rod immediately and reinject mortar.</p>
10d		<p>Wait for the specified curing time <math>t_{cure}</math> see <b>Table B9.2</b>.</p>
11d		<p>Tighten the hexagon nut with installation torque <math>T_{inst}</math> (see <b>Table B6.1</b>). Tighten lock nut manually, then use wrench to give another quarter to half turn. In the high corrosion resistant steel version, the lock nut is a thin nut. Tighten it with a torque of <math>\frac{1}{4} T_{inst}</math>.</p>



fischer Highbond-Anchor FHB / FHB dyn / FDA

**Intended use**  
Installation instructions part 7  
Push through installation FHB dyn

**Annex B17**  
Appendix 32 / 38

## Installation instructions part 8; Push through installation FHB dyn V

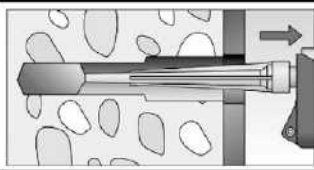
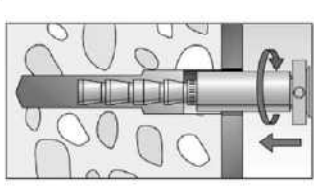
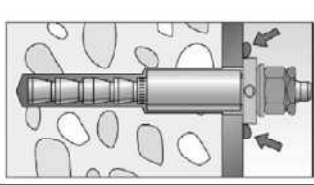
### Push through installation FHB dyn V

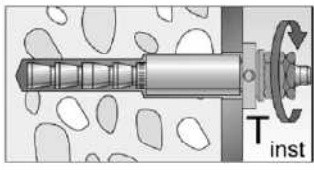
8e		<p>Fill approximately 2/3 of the drill hole incl. fixture with mortar. Always begin from the bottom of the hole and avoid bubbles. For drill hole depth <math>h_0 \geq 150</math> mm use an extension tube. For overhead installation or deep holes (<math>h_0 &gt; 250</math> mm) use an injection adapter.</p>
9e	 	<p>Push the pre-assembled fischer anchor rod (with shear force sleeve, centering sleeve, fischer filling disc, spherical washer, hexagon nut and lock nut) into the drill hole until the fischer filling disc is in full contact with the surface, turning it slightly while doing so. Ensure the correct position of the metal parts and the centering sleeve. Only use clean and oil-free metal parts.</p> <p>After inserting the pre-assembled anchor rod, excess mortar must be emerged around the fischer filling disc (minimum on one point). If not, pull out the assembled anchor rod immediately and reinject mortar.</p>
10e		<p>Wait for the specified curing time <math>t_{cure}</math> see <b>Table B9.2</b>.</p>
11e		<p>Tighten the hexagon nut with installation torque <math>T_{inst}</math> (see <b>Table B7.1</b>). Tighten lock nut manually, then use wrench to give another quarter to half turn.</p>

fischer Highbond-Anchor FHB / FHB dyn / FDA

#### Intended use



Installation instructions part 8  
Push through installation FHB dyn V

**Annex B18**

Appendix 33 / 38

## Installation instructions part 9; Push through installation FDA

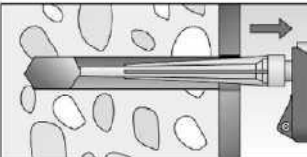
### Push through installation FDA

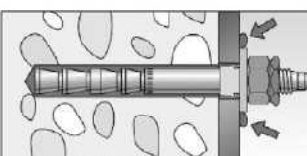
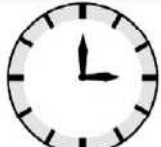
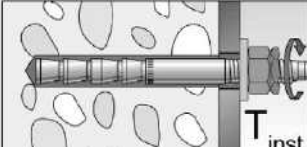
8f		<p>Fill approximately 2/3 of the drill hole incl. fixture with mortar. Always begin from the bottom of the hole and avoid bubbles. For drill hole depth <math>h_0 \geq 150</math> mm use an extension tube. For overhead installation or deep holes (<math>h_0 &gt; 250</math> mm) use an injection adapter.</p>
9f	 	<p>Push the pre-assembled fischer anchor rod (with centering sleeve, washer, hexagon nut and lock nut) into the drill hole until the washer is in full contact with the surface, turning it slightly while doing so. Gently hammer the anchor to the setting depth. Ensure the correct position of the metal parts and the centering sleeve. Only use clean and oil-free metal parts.</p> <p>After inserting the pre-assembled anchor rod, excess mortar must be emerged under the entire washer. If not, pull out the assembled anchor rod immediately and reinject mortar.</p>
10f		<p>Wait for the specified curing time <math>t_{cure}</math> see <b>Table B9.2</b>.</p>
11f		<p>Tighten the hexagon nut with installation torque <math>T_{inst}</math> (see <b>Table B8.1</b>). Tighten lock nut manually, then use wrench to give another quarter to half turn.</p>

fischer Highbond-Anchor FHB / FHB dyn / FDA

**Intended use**  
Installation instructions part 9  
Push through installation FDA

**Annex B19**  
Appendix 34 / 38

**Table C1.1: Characteristic resistance to steel failure under tension / shear loading for fischer anchor rods FHB-A / FHB-A N / FHB-A dyn (V) / FDA**

Anchor rod size			10x60	12x80	12x100	16x125	20x170	24x220		
<b>Characteristic resistance to steel failure under tension loading</b>										
Characteristic resistance $N_{Rk,s}$	FHB-A / FHB-A N	zp	8.8	[kN]	25,8	44,3	44,3	81,7	130,8 <sup>2)</sup>	179,8 <sup>2)</sup>
		zp	5.8		16,1	27,7	27,7	51,1	- <sup>3)</sup>	- <sup>3)</sup>
		hdg	8.8		25,8	44,3	44,3	81,7	190,2	261,5
		R	80		25,8	44,3	44,3	81,7	166,5 <sup>4)</sup>	228,8 <sup>4)</sup>
		HCR	70		22,5	38,8	38,8	71,5	166,5	228,8
	FHB-A dyn	zp	8.8		- <sup>3)</sup>	- <sup>3)</sup>	44,3	81,7	190,2	261,5
		HCR	70		- <sup>3)</sup>	- <sup>3)</sup>	38,8	71,5	- <sup>3)</sup>	- <sup>3)</sup>
	FHB-A dyn V	zp	8.8		- <sup>3)</sup>	- <sup>3)</sup>	44,3	81,7	- <sup>3)</sup>	- <sup>3)</sup>
	FDA	zp	8.8		- <sup>3)</sup>	- <sup>3)</sup>	44,3	81,7	- <sup>3)</sup>	- <sup>3)</sup>

**Partial factors <sup>1)</sup>**

Partial factor	$\gamma_{Ms,N}$	[-]	1,50
----------------	-----------------	-----	------

**Characteristic resistance to steel failure under shear loading**

**without lever arm**

Characteristic resistance $V^0_{Rk,s}$	FHB-A / FHB-A N	zp	8.8	[kN]	16,6	28,1	28,1	52,2	61,1 <sup>2)</sup>	90,8 <sup>2)</sup>
		zp	5.8		10,4	17,6	17,6	32,7	- <sup>3)</sup>	- <sup>3)</sup>
		hdg	8.8		16,6	28,1	28,1	52,2	98,0	141,2
		R	80		24,8	32,8	32,8	62,8	85,8 <sup>4)</sup>	152,6 <sup>4)</sup>
		HCR	70		25,1	36,9	36,9	55,0	85,8	141,1
	FHB-A dyn	zp	8.8		- <sup>3)</sup>	- <sup>3)</sup>	28,1	52,2	98,0	141,2
		HCR	70		- <sup>3)</sup>	- <sup>3)</sup>	36,9	55,0	- <sup>3)</sup>	- <sup>3)</sup>
	FHB-A dyn V	zp	8.8		- <sup>3)</sup>	- <sup>3)</sup>	56,9	96,2	- <sup>3)</sup>	- <sup>3)</sup>
	FDA	zp	8.8		- <sup>3)</sup>	- <sup>3)</sup>	28,1	52,2	- <sup>3)</sup>	- <sup>3)</sup>

Ductility factor	$k_7$	[-]	1,0
------------------	-------	-----	-----

**with lever arm**

Characteristic resistance $M^0_{Rk,s}$	FHB-A / FHB-A N	zp	8.8	[Nm]	59,8	104,8	104,8	266,4	357,0 <sup>2)</sup>	617,4 <sup>2)</sup>
		zp	5.8		37,4	65,5	65,5	166,5	- <sup>3)</sup>	- <sup>3)</sup>
		hdg	8.8		59,8	104,8	104,8	266,4	519,3	898,0
		R	80		59,8	104,8	104,8	266,4	454,4 <sup>4)</sup>	785,8 <sup>4)</sup>
		HCR	70		52,3	91,7	91,7	233,1	454,4	785,8
	FHB-A dyn	zp	8.8		- <sup>3)</sup>	- <sup>3)</sup>	104,8	266,4	519,3	898,0
		HCR	70		- <sup>3)</sup>	- <sup>3)</sup>	91,7	233,1	- <sup>3)</sup>	- <sup>3)</sup>
	FHB-A dyn V	zp	8.8		- <sup>3)</sup>	- <sup>3)</sup>	104,8	266,4	- <sup>3)</sup>	- <sup>3)</sup>
	FDA	zp	8.8		- <sup>3)</sup>	- <sup>3)</sup>	104,8	266,4	- <sup>3)</sup>	- <sup>3)</sup>

**Partial factors <sup>1)</sup>**

Partial factor	$\gamma_{Ms,V}$	[-]	1,25
----------------	-----------------	-----	------

<sup>1)</sup> In absence of other national regulations

<sup>2)</sup>  $f_{yk} = 440 \text{ N/mm}^2 / f_{uk} = 550 \text{ N/mm}^2$

<sup>3)</sup> No performance assessed

<sup>4)</sup>  $f_{yk} = 560 \text{ N/mm}^2 / f_{uk} = 700 \text{ N/mm}^2$

fischer Highbond-Anchor FHB / FHB dyn / FDA

**Performance**

Characteristic resistance to steel failure under tension / shear loading for fischer anchor rods FHB-A / FHB-A N / FHB-A dyn (V) / FDA

**Annex C1**

Table C2.1: Characteristic resistance to concrete failure under tension / shear loading										
			FHB / FHB N / FHB dyn (V) / FDA							
Size			All sizes							
<b>Tension loading</b>										
Installation factor		$\gamma_{inst}$	[-]		See Annex C3					
<b>Factors for the compressive strength of concrete &gt; C20/25</b>										
Increasing factor		C25/30	$\Psi_c$		[-]		1,10			
		C30/37					1,22			
$\Psi_c$ for concrete		C35/45					1,34			
$N_{Rk,p (X,Y) =}$		C40/50					1,41			
$\Psi_c \cdot N_{Rk,p (C20/25)}$		C45/55					1,48			
		C50/60					1,55			
<b>Splitting failure</b>										
Edge distance		$C_{cr,sp}$	[mm]		2 $h_{ef}$					
Spacing		$S_{cr,sp}$			2 $C_{cr,sp}$					
<b>Concrete failure</b>										
Uncracked concrete		$k_{ucr,N}$	[-]		11,0					
Cracked concrete		$k_{cr,N}$			7,7					
Edge distance		$C_{cr,N}$	[mm]		1,5 $h_{ef}$					
Spacing		$S_{cr,N}$			2 $C_{cr,N}$					
<b>Shear loading</b>										
Installation factor		$\gamma_{inst}$	[-]		1,0					
<b>Concrete pry-out failure</b>										
Factor for pry-out failure		$k_8$	[-]		2,0					
<b>Concrete edge failure</b>										
Anchor size			10x60	12x80	12x100	12x100 V	16x125	16x125 V	20x170	24x220
Effective length of anchor		$l_f$	60	80	100	105	125	130	170	220
Effective diameter of the fastener		$d_{nom}$	12	14	14	20	18	28	24	28
fischer Highbond-Anchor FHB / FHB dyn / FDA										
<b>Performance</b> Characteristic resistance to concrete failure under tension / shear loading			<b>Annex C2</b> Appendix 36 / 38							

**Table C3.1: Characteristic resistance to pull-out failure for fischer anchor rods FHB-A / FHB-A N / FHB-A dyn (V) / FDA in compacted reinforced or unreinforced normal weight concrete **without** fibers**

Anchor rod size			10x60	12x80	12x100	16x125	20x170	24x220		
<b>Pull-out failure</b>										
Calculation diameter	d	[mm]	10	12	12	16	20	24		
<b>Uncracked concrete</b>										
<b>Characteristic resistance in uncracked concrete C20/25</b>										
Temperature range	I: 24 °C / 40 °C		N <sub>Rk,p</sub>	[kN]	26,9	41,3	42,1	70,5	113,6	122,2
	II: 50 °C / 80 °C				23,7	36,3	37,0	62,0	100,0	107,5
<b>Cracked concrete</b>										
<b>Characteristic resistance in cracked concrete C20/25</b>										
Temperature range	I: 24 °C / 40 °C		N <sub>Rk,p</sub>	[kN]	15,5	25,0	30,0	47,8	58,9	89,4
	II: 50 °C / 80 °C				13,6	22,0	26,4	42,1	51,8	78,7
<b>Installation factors</b>										
Dry or wet concrete	γ <sub>inst</sub>	[-]	1,0							
Water filled hole			1,0	1,0	1,0	1,2	1,0	1,0		

**Table C3.2: Characteristic resistance to pull-out failure for fischer anchor rods FHB-A / FHB-A N / FHB-A dyn (V) / FDA in compacted reinforced or unreinforced normal weight concrete **with** fibers**

Anchor rod size			12x100			16x125			
<b>Pull-out failure</b>									
Calculation diameter	d	[mm]	12			16			
<b>Uncracked concrete</b>									
<b>Characteristic resistance in uncracked concrete C20/25</b>									
Temperature range	I: 24 °C / 40 °C		N <sub>Rk,p</sub>	[kN]	42,1			70,5	
	II: 50 °C / 80 °C				37,0			62,0	
<b>Cracked concrete</b>									
<b>Characteristic resistance in cracked concrete C20/25</b>									
Temperature range	I: 24 °C / 40 °C		N <sub>Rk,p</sub>	[kN]	30,0			47,8	
	II: 50 °C / 80 °C				26,4			42,1	
<b>Installation factors</b>									
Dry or wet concrete	γ <sub>inst</sub>	[-]	1,0						
Water filled hole			1,0			1,2			

**Table C4.1: Displacements for fischer anchor rods  
FHB-A / FHB-A N / FHB-A dyn (V) / FDA**

Anchor rod size		10x60	12x80	12x100	16x125	20x170	24x220	
<b>Displacement-Factors for tension loading <sup>1)</sup></b>								
<b>Uncracked concrete; Temperature range I, II</b>								
Displacements	$\frac{\delta_{N0}}{\delta_{N\infty}}$	[mm/kN]	0,025	0,010	0,010	0,007	0,006	0,006
			0,050	0,020	0,020	0,014	0,012	0,012
<b>Cracked concrete; Temperature range I, II</b>								
Displacements	$\frac{\delta_{N0}}{\delta_{N\infty}}$	[mm/kN]	0,040	0,020	0,020	0,020	0,020	0,020
			0,060	0,030	0,030	0,030	0,030	0,030
<b>Displacement-Factors for shear loading <sup>2)</sup></b>								
<b>Uncracked or cracked concrete; Temperature range I, II</b>								
Displacements	$\frac{\delta_{V0}}{\delta_{V\infty}}$	[mm/kN]	0,025	0,010	0,010	0,007	0,006	0,006
			0,050	0,020	0,020	0,014	0,012	0,012

1) Calculation of effective displacement:

$$\delta_{N0} = \delta_{N0\text{-Factor}} \cdot N$$

$$\delta_{N\infty} = \delta_{N\infty\text{-Factor}} \cdot N$$

(N: acting tension loading)

2) Calculation of effective displacement:

$$\delta_{V0} = \delta_{V0\text{-Factor}} \cdot V$$

$$\delta_{V\infty} = \delta_{V\infty\text{-Factor}} \cdot V$$

(V: acting shear loading)

fischer Highbond-Anchor FHB / FHB dyn / FDA

**Performance**

Displacements for fischer anchor rods FHB-A / FHB-A N / FHB-A dyn (V) / FDA

**Annex C4**