

ΔΗΛΩΣΗ ΕΠΙΔΟΣΕΩΝ

DoP 0267

για fischer Ceiling Anchor FDN II (Εκτομούμενα αγκύρια για χρήση σε μπετόν)

EL

- | | |
|--|--|
| <p>1. <u>Μοναδικός κωδικός ταυτοποίησης του τύπου του</u></p> <p>2. <u>Προβλεπόμενη(-ες) χρήση(-εις):</u></p> <p>3. <u>Κατασκευαστής:</u></p> <p>4. <u>Εξουσιοδοτημένος αντιπρόσωπος:</u></p> <p>5. <u>Σύστημα/συστήματα AVCP (αξιολόγηση και επαλήθευση της σταθερότητας της επίδοσης):</u></p> <p>6. <u>Ευρωπαϊκό έγγραφο αξιολόγησης:</u>
Ευρωπαϊκή τεχνική αξιολόγηση:
Οργανισμός τεχνικής αξιολόγησης:
Κοινοποιημένος(-οι) οργανισμός(-οι):</p> <p>7. <u>Δηλωθείσα(-ες) επίδοση(-εις):</u>
Ασφάλεια στη χρήση (BWR 4)
Χαρακτηριστική αντίσταση σε εφελκυστικό φορτίο (στατικό και σχεδόν στατικό):
Αντίσταση σε αστοχία χάλυβα:
Αντίσταση σε αστοχία από εξόλκευση:
Αντίσταση σε αστοχία από κώνο σκυροδέματος:
Ανθεκτικότητα:
Ελάχιστη απόσταση από ακμή και μεταξύ αγκυρίων:
Απόσταση από ακμή για αποφυγή θραύσης από φορτίο:</p> <p>Χαρακτηριστική αντίσταση σε διατμητικό φορτίο (στατικό και σχεδόν στατικό):
Αντίσταση σε αστοχία χάλυβα (διατμητικό φορτίο):
Αντίσταση σε ολίσθηση:
Αντίσταση σε αστοχία ακμής σκυροδέματος:</p> <p>Χαρακτηριστική αντίσταση για όλες τις κατευθύνσεις φόρτισης και μορφές αστοχίας για συνήθη σχεδιασμό:
Χαρακτηριστική αντίσταση:</p> <p>Διάρκεια:
Διάρκεια:</p> <p>Ασφάλεια σε περίπτωση φωτιάς (BWR 2)
Αντίδραση σε φωτιά:</p> <p>Αντίσταση στη φωτιά:
Αντίσταση σε φωτιά για αστοχία χάλυβα (εφελκυστικό φορτίο):
Αντίσταση σε φωτιά για εξόλκευση (εφελκυστικό φορτίο):
Αντίσταση σε φωτιά για αστοχία χάλυβα (διατμητικό φορτίο):
Αντίσταση σε φωτιά και όλες τις κατευθύνσεις φόρτισης και μορφές αστοχίας:</p> <p>8. <u>Κατάλληλη τεχνική τεκμηρίωση και/ή ειδική τεχνική τεκμηρίωση:</u></p> | <p>DoP 0267
Μεταγενέστερη αγκύρωση σε σκυρόδεμα για μη φέρουσες κατασκευές , δείτε το παράρτημα, ειδικά τα παραρτήματα B1 - B2.</p> <p>fischerwerke GmbH & Co. KG, Klaus-Fischer-Str. 1, 72178 Waldachtal, Γερμανία</p> <p>–</p> <p>2+</p> <p>ETAG 001 Part 6, April 2013, χρησιμοποιείται ως EAD
ETA-17/0736; 2018-01-30
DIBt- Deutsches Institut für Bautechnik
2873 TU Darmstadt</p> <p>NPD
NPD
NPD
Παράρτημα C1
Παραρτήματα B2, C1
NPD</p> <p>Παράρτημα C1
NPD
NPD</p> <p>Παράρτημα C1</p> <p>Παράρτημα B1</p> <p>Κατηγορίας (A1)</p> <p>NPD
NPD
NPD
Παράρτημα C1</p> <p>–</p> |
|--|--|

Η επίδοση του προϊόντος που ταυτοποιείται ανωτέρω είναι σύμφωνη με τη (τις) δηλωθείσα(-ες) επίδοση(-εις). Αυτή η δήλωση επιδόσεων εκδίδεται σύμφωνα με τον Κανονισμό (ΕΕ) Αρ. 305/2011 με αποκλειστική ευθύνη του κατασκευαστή που προσδιορίζεται παραπάνω.

Υπογραφή για λογαριασμό και εξ ονόματος του κατασκευαστή από:



Dr.-Ing. Oliver Geibig, Γενικός Διευθυντής Επιχειρηματικών Μονάδων & Μηχανικής
Tumlingen, 2021-01-11



Jürgen Grün, Γενικός Διευθυντής Χημικών & Ποιότητας

Αυτή η Δήλωση Επιδόσεων μεταφράστηκε σε διάφορες γλώσσες. Σε περίπτωση που υπάρχει αμφιβολία για τη μετάφραση, υπερισχύει πάντα η αγγλική έκδοση.

Το παράρτημα περιλαμβάνει προαιρετικές και συμπληρωματικές πληροφορίες στα αγγλικά, που ξεπερνούν τις (οριζόμενες σε άλλες γλώσσες) νόμιμες απαιτήσεις.

Specific Part

1 Technical description of the product

The Fischer Ceiling Anchor FDN II is an anchor made of galvanized steel which is placed into a drilled hole and anchored by deformation-controlled expansion.

The product description is given in Annex A.

2 Specification of the intended use in accordance with the applicable European Assessment Document

The performances given in Section 3 are only valid if the anchor is used in compliance with the specifications and conditions given in Annex B.

The verifications and assessment methods on which this European Technical Assessment is based lead to the assumption of a working life of the anchor of at least 50 years. The indications given on the working life cannot be interpreted as a guarantee given by the producer, but are to be regarded only as a means for choosing the right products in relation to the expected economically reasonable working life of the works.

3 Performance of the product and references to the methods used for its assessment

3.1 Mechanical resistance and stability (BWR 1)

The essential characteristics regarding mechanical resistance and stability are included under the Basic Works Requirement Safety in use.

3.2 Safety in case of fire (BWR 2)

Essential characteristic	Performance
Reaction to fire	Anchorage satisfies requirements for Class A1
Resistance to fire	See Annex C 1

3.3 Safety in use (BWR 4)

Essential characteristic	Performance
Characteristic resistance in concrete	See Annex C 1

4 Assessment and verification of constancy of performance (AVCP) system applied, with reference to its legal base

In accordance with guideline for European technical approval ETAG 001, April 2013 used as European Assessment Document (EAD) according to Article 66 Paragraph 3 of Regulation (EU) No 305/2011 the applicable European legal act is: [97/161/EC].

The system to be applied is: 2+

Product installation conditions, product marking and product dimensions

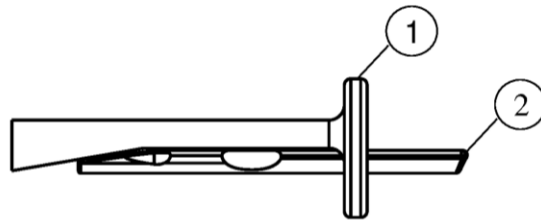

- ① Shaft
- ② Pin

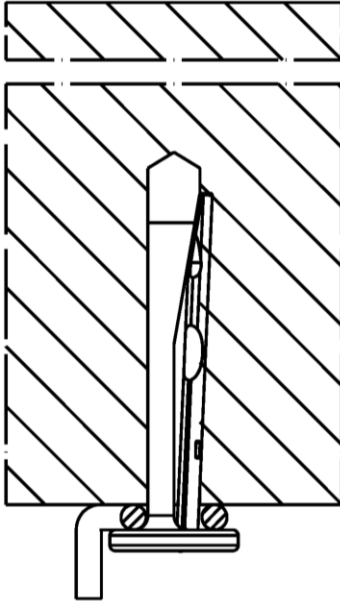

Type of fastener

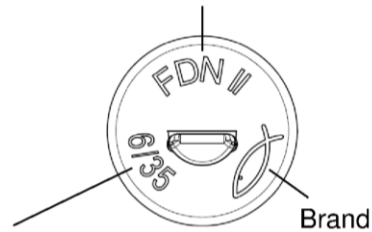

Brand

Nominal diameter / max. thickness of the fixture;
Additional marking "K" for $h_{ef} = 25$ mm

Table A1.1: Dimensions

Size	FDN II			
	6/5 K	6/5	6/35 K	6/35
Length of the $\frac{\text{pin}}{\text{shaft}}$ L_1	36	43	66	73
L_2 [mm]	30,5	37,5	60,5	67,5
Diameter of the head $D \geq$	13			

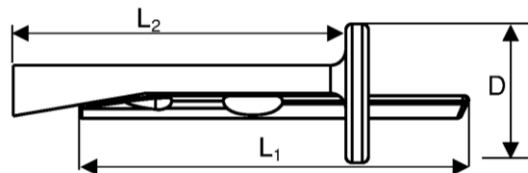

(Fig. not to scale)

fischer Ceiling Anchor FDN II

Product description

Product installation conditions, product marking and product dimensions

Annex A 1

Appendix 2 / 5

Specifications of intended use

Anchorage subject to:

Size	FDN II 6
Static and quasi-static loads	
Use for multiple fixture of non-structural applications according to ETAG 001, Part 6	✓
Fire exposure	

Base materials:

- Reinforced and unreinforced normal weight concrete according to EN 206-1:2000
- Strength classes C12/15 to C50/60 according to EN 206-1:2000
- Cracked and non-cracked concrete

Use conditions (Environmental conditions):

- Anchorage subject to dry internal conditions

Design:

- Anchorages are designed under the responsibility of an engineer experienced in anchorages and concrete work
- Verifiable calculation notes and drawings have to be prepared taking account of the loads to be anchored. The position of the anchor is indicated on the design drawings (e.g. position of the anchor relative to reinforcement or to supports, etc.).
- Anchorages under static or quasi-static actions have to be designed for Design Method C in accordance with:
 - ETAG 001, Annex C, Design Method C, Edition August 2010
 - CEN/TS 1992-4:2009
- Anchorages under fire exposure have to be designed in accordance with
 - EOTA Technical Report TR 020, Edition May 2004
 - CEN/TS 1992-4:2009, Annex D (it must be ensured that local spalling of the concrete cover does not occur)

fischer Ceiling Anchor FDN II

Intended use
Specifications

Annex B 1

Appendix 3 / 5

Table B2.1: Installation parameters

Size		FDN II			
		6/5 K	6/5	6/35 K	6/35
Thickness of the fixture	$t_{fix} \leq$	5		35	
Nominal drill hole diameter	d_0	6			
Diameter of clearance hole in the fixture	$d_f \leq$	7			
Maximum bit diameter	$d_{cut,max}$	6,40			
Effective embedment depth	h_{ef}	25	32	25	32
Depth of drill hole to deepest point	with hole cleaning	30	37	30	37
	without hole cleaning	35	42	35	42
Minimum thickness of concrete member	h_{min}	80			

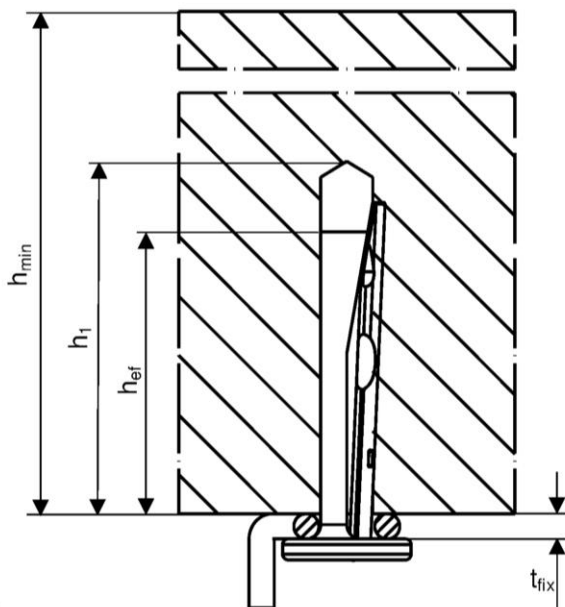

Installation instructions

- Hammer or hollow drilling only
- Anchor installation carried out by appropriately qualified personnel and under the supervision of the person responsible for technical matters of the site
- Positioning of the drill holes without damaging the reinforcement
- In case of aborted hole: New drilling at a minimum distance twice the depth of aborted hole away of or smaller distance if the aborted hole is filled with high strength mortar and if under shear or oblique tension load it is not in the direction of the load application

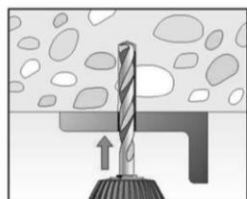

1: Drill the hole

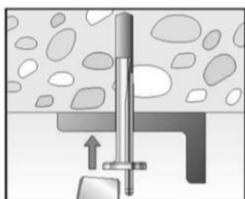

2: Set the fastener

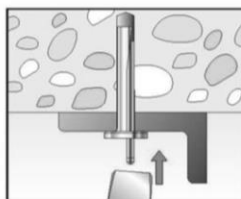

3: Set the pin, until flush to the surface

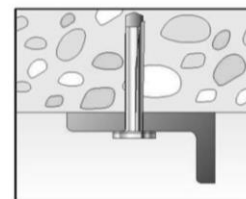

4: Installed fastener

(Fig. not to scale)

fischer Ceiling Anchor FDN II

Intended use

Installation parameters and installation instructions

Annex B 2

Appendix 4 / 5

Table C1.1: Characteristic resistance

Size	FDN II 6	
For all load directions and for all failures modes		
Effective embedment depth	h_{ef} [mm]	25 32
Characteristic resistance in cracked and non-cracked concrete	C12/15	2,0 2,5
	C20/25 to C50/60	2,5 3,5
Characteristic edge distance	$c_{cr,N} = c_{min}$ [mm]	70 60
	spacing	$s_{cr,N} = s_{min}$ [mm]
Partial safety factor	$\gamma_M^{2)}$ [-]	1,5
Shear load with lever arm		
Characteristic bending resistance	$M_{Rk,s}^0$ [Nm]	4,4
Partial safety factor for steel failure	$\gamma_{Ms}^{1)}$ [-]	1,25

¹⁾ In absence of other national regulations

²⁾ The installation safety factor $\gamma_2 = \gamma_{inst} = 1,0$ is included

Table C1.2: Characteristic resistance under fire exposure for all effective embedment depths

Size	FDN II 6	
Steel failure for tension and shear load		
R30	$F_{Rk,s,fi30}$	1,00
R60	$F_{Rk,s,fi60}$	0,50
R90	Characteristic resistance $F_{Rk,s,fi90}$ [kN]	0,34
R120	$F_{Rk,s,fi120}$	0,26
R180	$F_{Rk,s,fi180}$	0,17
Spacing and edge distance		
R30 – R120	$s_{cr,fi}$ [mm]	200
	$c_{cr,fi}$	150

For fire exposure from more than one side $c_{min} \geq 300$ mm