

ΔΗΛΩΣΗ ΕΠΙΔΟΣΕΩΝ

DoP 0323

για fischer universal plug DuoPower ETA (Πλαστικό αγκύριο για χρήση σε σκυρόδεμα και τούβλο)

EL

- Μοναδικός κωδικός ταυτοποίησης του τύπου του προϊόντος: DoP 0323
- Προβλεπόμενη(-ες) χρήση(-εις): Πλαστικό αγκύριο για πολλαπλές χρήσεις σε σκυρόδεμα και τούβλο μη φερούσων εφαρμογών (χρήση σε κατηγορία a,b, c);, δείτε το παράρτημα, ειδικά τα παραρτήματα B1 - B4.
- Κατασκευαστής: fischerwerke GmbH & Co. KG, Klaus-Fischer-Str. 1, 72178 Waldachtal, Γερμανία
- Εξουσιοδοτημένος αντιπρόσωπος: -
- Σύστημα/συστήματα AVCP (αξιολόγηση και επαλήθευση της σταθερότητας της επίδοσης): 2+
- Ευρωπαϊκό έγγραφο αξιολόγησης: EAD 330284-00-0604 (June 2018)
Ευρωπαϊκή τεχνική αξιολόγηση: ETA-22/0512; 2022-11-04
Οργανισμός τεχνικής αξιολόγησης: Kiwa Nederland B.V.
Κοινοποιημένος(-οι) οργανισμός(-οι): 2873 TU Darmstadt
- Δηλωθείσα(-ες) επίδοση(-εις):
Μηχανική αντιστάση και σταθερότητα (BWR 4)
Αντίσταση σε αστοχία χάλυβα υπό εφελκυστικό φορτίο: Παράρτημα C1
Αντίσταση σε αστοχία χάλυβα ή polymer υπό διατμητικό φορτίο: Παραρτήματα C1, C2
Αντίσταση σε εξόλκευση ή αστοχία σκυροδέματος ή polymer υπό εφελκυστικό φορτίο: (δομικό υλικό ομάδας a): Παράρτημα C2

Αντίσταση σε φορτίο όλων των κατευθύνσεων χωρίς μοχλό (δομικό υλικό ομάδας b, c): Παράρτημα C3
Απόσταση από ακμή και μεταξύ αγκυρίων (δομικό υλικό ομάδας a): Παράρτημα B2
Απόσταση από ακμή και μεταξύ αγκυρίων (δομικό υλικό ομάδας b, c): Παράρτημα B3
Μετατόπιση σε βραχείας διάρκειας και μακράς διάρκειας φόρτιση: Παράρτημα C2

Ανθεκτικότητα: Παραρτήματα A4, B1

Ασφάλεια σε περίπτωση φωτιάς (BWR 2)
Αντίδραση σε φωτιά: Κατηγορίας A 1
Αντίσταση στη φωτιά: NPD
- Κατάλληλη τεχνική τεκμηρίωση και/ή ειδική τεχνική τεκμηρίωση: -

Η επίδοση του προϊόντος που ταυτοποιείται ανωτέρω είναι σύμφωνη με τη (τις) δηλωθείσα(-ες) επίδοση(-εις). Αυτή η δήλωση επιδόσεων εκδίδεται σύμφωνα με τον Κανονισμό (ΕΕ) Αρ. 305/2011 με αποκλειστική ευθύνη του κατασκευαστή που προσδιορίζεται παραπάνω.

Υπογραφή για λογαριασμό και εξ ονόματος του κατασκευαστή από:



Dr.-Ing. Oliver Geibig, Γενικός Διευθυντής Επιχειρηματικών Μονάδων & Μηχανικής
Tumlingen, 2022-11-24



Jürgen Grün, Γενικός Διευθυντής Χημικών & Ποιότητας

Αυτή η Δήλωση Επιδόσεων μεταφράστηκε σε διάφορες γλώσσες. Σε περίπτωση που υπάρχει αμφιβολία για τη μετάφραση, υπερισχύει πάντα η αγγλική έκδοση.

Το παράρτημα περιλαμβάνει προαιρετικές και συμπληρωματικές πληροφορίες στα αγγλικά, που ξεπερνούν τις (οριζόμενες σε άλλες γλώσσες) νόμιμες απαιτήσεις.

Translation guidance Essential Characteristics and Performance Parameters for Annexes

Οδηγίες Μετάφρασης των βασικών χαρακτηριστικών και απόδοσης για τα παραρτήματα

Safety in case of fire (BWR 2)

Ασφάλεια σε περίπτωση φωτιάς (BWR 2)

1	Reaction to fire: Αντίδραση σε φωτιά:	-
2	Resistance to fire: Αντίσταση στη φωτιά:	$N_{Rk,s,fi}$; $N_{Rk,p,fi}$; $F_{Rk,fi,90}$

Mechanical resistance and stability (BWR 4)

Μηχανική αντίσταση και σταθερότητα (BWR 4)

3	Resistance to steel failure under tension loading: Αντίσταση σε αστοχία χάλυβα υπό εφελκυστικό φορτίο:	$N_{Rk,s}$
4	Resistance to steel or polymer failure under shear loading: Αντίσταση σε αστοχία χάλυβα ή πολυμερ υπό διατμητικό φορτίο:	$V_{Rk,s}$; $M_{Rk,s}$; $V_{Rk,pol}$
5	Resistance to pull-out or concrete failure or polymer failure under tension loading (base material group a) Αντίσταση σε εξόλκευση ή αστοχία σκυροδέματος ή πολυμερ υπό εφελκυστικό φορτίο: (δομικό υλικό ομάδας a):	$N_{Rk,p}$ / $N_{Rk,pol}$
6	Resistance in any load direction without lever arm (base material group b,c,d): Αντίσταση σε φορτίο όλων των κατευθύνσεων χωρίς μοχλό (δομικό υλικό ομάδας b, c):	F_{Rk}
7	Edge distance and spacing (base material group a) Απόσταση από ακμή και μεταξύ αγκυριών (δομικό υλικό ομάδας a):	c_{cr} ; s_{cr} ; c_{min} ; s_{min} ; a ; h_{min}
8	Edge distance and spacing (base material group b,c,d): Απόσταση από ακμή και μεταξύ αγκυριών (δομικό υλικό ομάδας b, c):	c_{min} ; s_{min} ; h_{min}
9	Displacements under short-term and long-term loading: Μετατόπιση σε βραχείας διάρκειας και μακράς διάρκειας φόρτιση:	δ_0 ; δ_∞

Aspects of durability

Ανθεκτικότητα:

10	Durability: Ανθεκτικότητα:	-
----	--------------------------------------	---

Specific parts

1 Technical description of the product

The plastic anchor “fischer universal plug DuoPower ETA” is a plastic anchor consisting of a sleeve and a screw. The plastic sleeve is expanded by screwing in the screw which presses the sleeve against the wall of the drilled hole.

Polyamide PA6 of grey colour and polypropylene PP of red colour is used as material for the sleeve. The screws are made of galvanised steel, galvanised steel with additional organic layer or stainless steel of corrosion resistance class II or III. There are three variants of the fischer PowerFast II: a countersunk screw, a raised countersunk head screw, a pan head screw, according to ETA-19/0175. There are also three variants of the special screw: a countersunk screw, a hexagonal screw and a hexagonal screw with washer. Specific dimensions, drawings and material parameters are shown in Annex A.

2 Specification of the intended use(s) in accordance with the applicable European Assessment Document (hereinafter EAD)

The performances given in section 3 are only valid if the anchor is used in compliance with the specifications and conditions given in Annex B.

The plastic anchor “fischer universal plug DuoPower ETA” is intended for anchorages subject to static and quasi-static loading. The applicable base material groups are “a”, “b” and “c”.

The verifications and assessment methods on which this European Technical Assessment is based on lead to the assumption of a working life of the plastic anchor “fischer universal plug DuoPower ETA” for the intended use of 50 years when installed in the works provided that the plastic anchor is subject to appropriate installation.

The indications given on the working life cannot be interpreted as a guarantee given by the producer, but are to be regarded only as a means for choosing the right products in relation to the expected economically reasonable working life of the works.

3 Performance of the product and references to the methods used for its assessment

3.1 Basic Works Requirements 2: Safety in case of fire

Table 3.1 Basic Works Requirements 2: Safety in case of fire

Essential characteristic	Performance
Reaction to fire	Class A 1
Resistance to fire	no performance assessed

3.2 Basic Works Requirements 4: Mechanical resistance and stability

Table 3.2 Basic Works Requirements 4: Mechanical resistance and stability

Essential characteristic	Performance
Characteristic resistance to steel failure under tension loading	see Annex C 1
Characteristic resistance to steel or polymer failure under shear loading	see Annex C 1 and Annex C 2
Characteristic resistance to pull-out or concrete failure or polymer failure under tension loading (only base material group "a")	see Annex C 2
Characteristic resistance in any load direction without lever arm (only base material group "b" and "c")	see Annex C 3
Minimum edge distances and spacing	see Annex B 2 and Annex B 3
Displacements under short-term and long-term loading	see Annex C 2

3.3 Other essential characteristics

Table 3.3 Other essential characteristics

Essential characteristic	Performance	
Durability	Corrosion of Metal parts	for screws see Annex A 4 and Annex B 1
	High alkalinity of plastic sleeve	no negative effects

3.4 Reference documents

Following standards or EADs will be referred to in this European Technical Assessment. All undated references are to be understood as references to the dated versions listed below.

- EOTA European Assessment Document EAD 330284-00-0604, June 2018: Plastic anchors for redundant non-structural systems in concrete and masonry
- EOTA Technical Report TR 051, Edition April 2018: Job site tests of plastic anchors and screws
- EOTA Technical Report TR 064, Edition May 2018: Design of plastic anchors in concrete and masonry
- EN 206:2013+A2:2021: Concrete – Specification, performance, production and conformity
- EN 771-1:2011+A1:2015: Specification for masonry units – Part 1: Clay masonry units
- EN 771-2:2011+A1:2015: Specification for masonry units – Part 2: Calcium silicate
- EN 998-2:2017: Specification for mortar for masonry - Part 2: Masonry mortar
- EN 1993-1-4:2006+A1:2015: Eurocode 3: Design of steel structures - Part 1-4: General rules - Supplementary rules for stainless steels
- EN ISO 4042:2018: Fasteners – Electroplated coating systems

4 Assessment and verification of constancy of performance (hereinafter AVCP) system applied, with reference to its legal base

In accordance with European Assessment Document EAD 330284-00-0604 the applicable European legal act is: 97/463/EC.

The System to be applied is: 2+

Installed anchor DuoPower ETA, e.g. with special screw

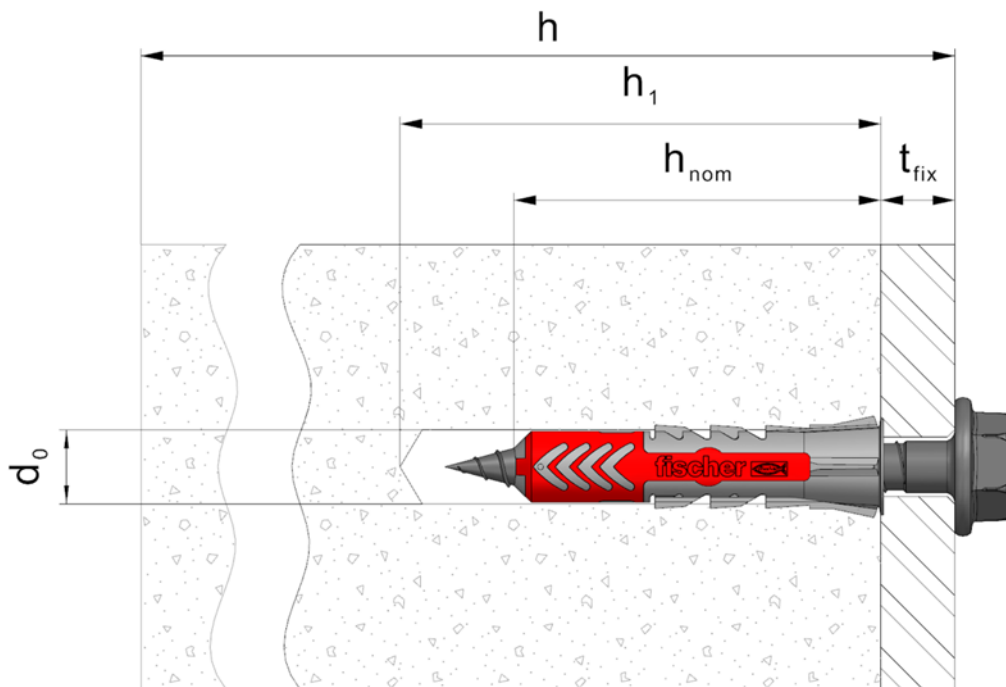

Legend

- d_0 = Nominal drill hole diameter
- h_{nom} = Overall plastic anchor embedment depth in the base material
- h_1 = Depth of drill hole to deepest point
- h = Thickness of member (wall)
- t_{fix} = Thickness of fixture including non-load-bearing layer

Figure not to scale

fischer universal plug DuoPower ETA

Product description
Installed anchor

Annex A 1
Appendix 4 / 14

Anchor sleeve DuoPower ETA 8 and 10

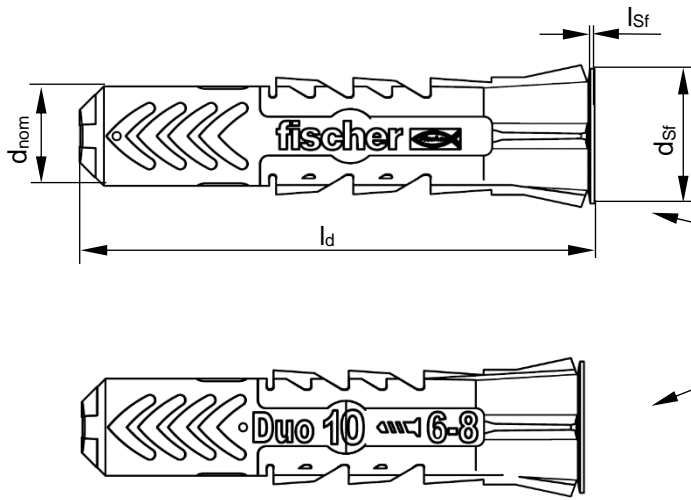

Marking:

Brand

Anchor type

Size

Screw diameter

e.g. fischer  Duo 10  6-8

e.g. fischer  Duo 8  4,5-6

Figures not to scale

fischer universal plug DuoPower ETA

Product description

Anchor sleeve types

Marking and dimensions

Annex A 2

Appendix 5 / 14

fischer PowerFast II

Countersunk screw

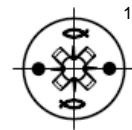
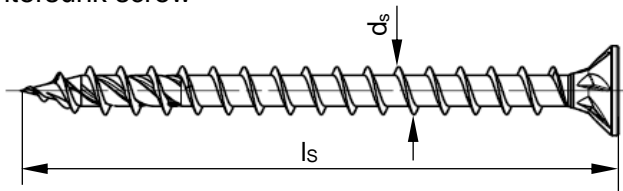

Raised countersunk head screw

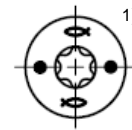
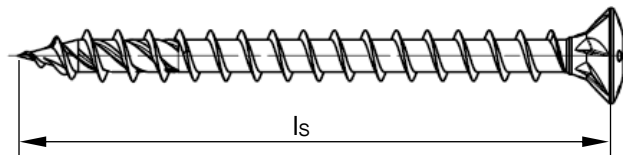

Pan head screw

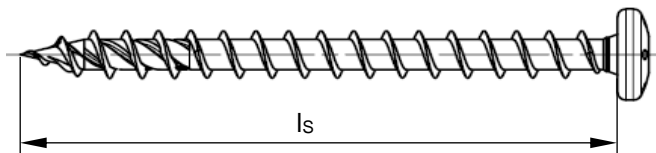

1) Internal driving feature for TX bit or cross recess bit for all head shapes.

Special screws

Countersunk screw

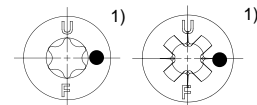
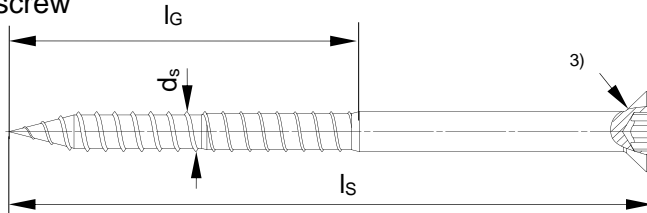

Hexagonal screw with washer

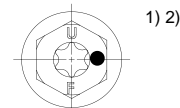
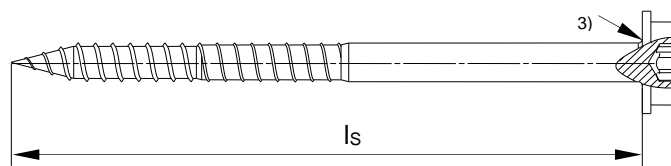

Hexagonal screw

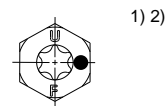
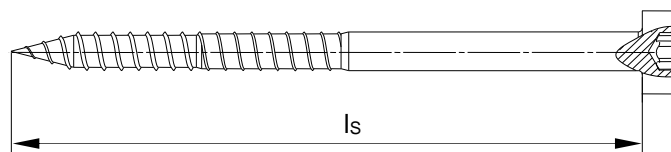

- 1) Additional marking for the special screw, stainless steel version: e.g. "A4" or "R" or "A2".
- 2) Internal driving feature for TX bit is optional for hexagonal screw.
- 3) Optional additional version with underhead ribs.

Figures not to scale

fischer universal plug DuoPower ETA

Product description

fischer PowerFast II and special screws
Marking and dimensions

Annex A 3

Appendix 6 / 14

Table A4.1: Dimensions of the anchor type with fischer PowerFast II

Anchor type	Anchor sleeve						fischer PowerFast II	
	h_{nom} [mm]	d_{nom} [mm]	t_{fix} [mm]	l_d [mm]	l_{sf} [mm]	d_{sf} [mm]	d [mm]	l_s [mm]
DuoPower ETA 8x40	40	8	≥ 1	40	0,4	11,0	6,0	$\geq l_d + t_{fix} + 6$

Table A4.2: Dimensions of the anchor type with special screw

Anchor type	Anchor sleeve						Special screw		
	h_{nom} [mm]	d_{nom} [mm]	t_{fix} [mm]	l_d [mm]	l_{sf} [mm]	d_{sf} [mm]	d [mm]	l_G [mm]	l_s [mm]
DuoPower ETA 8x40	40	8	≥ 1	40	0,4	11,0	6,0	$\frac{59}{77^{1)}$	$\geq l_d + t_{fix} + 6$
DuoPower ETA 10x50	50	10	≥ 1	50	0,4	13,0	7,0	$\frac{57}{77^{2)}$	$\geq l_d + t_{fix} + 7$

¹⁾ Screw length $l_s \geq 85$ mm.

²⁾ Screw length $l_s \geq 87$ mm.

Table A4.3: Materials

Name	Material
Anchor sleeve	Polyamide, PA6, colour grey Polypropylene PP, colour red
fischer PowerFast II	- Galvanised steel gvz with Zn5/Ag or Zn5/An in accordance with EN ISO 4042 <u>or</u> - Galvanised steel gvz with Zn5/Ag or Zn5/An in accordance with EN ISO 4042 with additional organic layer (Zn5/Ag/T7 or Zn5/An/T7, resp.) in three layers (total layer thickness $\geq 6 \mu\text{m}$)
Special screw	- Galvanised steel gvz with Zn5/Ag or Zn5/An in accordance with EN ISO 4042 <u>or</u> - Galvanised steel gvz with Zn5/Ag or Zn5/An in accordance with EN ISO 4042 with additional organic layer (Zn5/Ag/T7 or Zn5/An/T7, respectively) in three layers (total layer thickness $\geq 6 \mu\text{m}$) <u>or</u> - Stainless steel "A2" of corrosion resistance class CRC II in accordance with EN 1993-1-4 <u>or</u> - Stainless steel "A4" or "R" of corrosion resistance class CRC III in accordance with EN 1993-1-4

fischer universal plug DuoPower ETA

Product description
Dimensions and materials

Annex A 4
Appendix 7 / 14

Specifications of intended use

Anchorage subject to:

- Static and quasi-static loads.
- Multiple fastening of non-structural systems.

Base materials:

- Reinforced or unreinforced compacted normal weight concrete without fibres, strength classes \geq C12/15, base material group "a", in accordance with EN 206, see Annex C 2.
- Solid brick masonry, base material group "b", as per EN 771-1 or EN 771-2, see Annex C 3.
Note: The characteristic resistance is also valid for larger brick sizes and higher compressive strength of the masonry unit.
- Hollow or perforated brick masonry, base material group "c", as per EN 771-1, see Annex C 3.
- Mortar strength class of masonry \geq M2,5 in accordance with EN 998-2.
- For other comparable base materials of the base material group "a", "b" or "c", the characteristic resistance of the anchor may be determined by job site tests in accordance with TR 051.

Temperature Range:

- a: - 20 °C to 40 °C (max. short term temperature + 40 °C and max. long term temperature + 24 °C).

Use conditions (Environmental conditions):

- Structures subject to dry internal conditions: fischer PowerFast II of zinc coated steel or special screw made of zinc coated steel or stainless steel.
- Structures subject to external atmospheric exposure (including industrial and marine environment) and to permanently damp internal condition, if no particular aggressive conditions exist: Special screw made of stainless steel of corrosion resistance class CRC III.
Note: Particular aggressive conditions are e.g. permanent, alternating immersion in seawater or the splash zone of seawater, chloride atmosphere of indoor swimming pools or atmosphere with extreme chemical pollution (e.g. in desulphurization plants or road tunnels where de-icing materials are used).

Design:

- The anchorages are designed in accordance with TR 064 under the responsibility of an engineer experienced in anchorages and masonry work.
- Verifiable calculation notes and drawings shall be prepared taking account of the loads to be anchored, the nature and strength of the base materials and the dimensions of the anchorage members as well as of the relevant tolerances. The position of the anchor is indicated on the design drawings.
- Fasteners are only to be used for multiple use for non-structural application in accordance with TR 064.

Installation:

- Hole drilling by the drilling method according to Annex C 2 and C 3 for base material group "a", "b" and "c".
- Anchor installation carried out by appropriately qualified personnel and under the supervision of the person responsible for technical matters of the site.
- Installation temperature from -5 °C to +40 °C.
- Exposure to UV due to solar radiation of the anchor not protected \leq 6 weeks.
- No ingress of water in the borehole at temperatures $<$ 0 °C.

fischer universal plug DuoPower ETA

Intended use
Specifications

Annex B 1
Appendix 8 / 14

Table B2.1: Installation parameters

Anchor type		DuoPower ETA 8x40	DuoPower ETA 10x50
Nominal drill hole diameter	$d_0 =$ [mm]	8	10
Cutting diameter of drill bit	$d_{cut} \leq$ [mm]	8,45	10,45
Overall plastic anchor embedment depth in the base material ¹⁾	$h_{nom} =$ [mm]	40	50
Depth of drill hole to deepest point ¹⁾	$h_1 \geq$ [mm]	$l_s - t_{fix} + 10$	$l_s - t_{fix} + 10$
Diameter of clearance hole in the fixture	$d_f \leq$ [mm]	6,5	7,5

¹⁾ See Annex A 1.

Table B2.2: Minimum thickness of member, edge distances and spacing in concrete, base material group “a”

Anchor type	Embedment depth h_{nom} [mm]	Concrete strength class [-]	Minimum thickness of member h_{min} [mm]	Characteristic edge distance c_{cr} [mm]	Characteristic spacing s_{cr} [mm]	Minimum spacing and edge distances ¹⁾ s_{min}, c_{min} [mm]
DuoPower ETA 8x40 with fischer PowerFast II	40	C12/15	150	80	25	$s_{min}=70$ for $c \geq 140$ $c_{min}=70$ for $s \geq 140$
		$\geq C16/20$		55	15	$s_{min}=50$ for $c \geq 100$ $c_{min}=50$ for $s \geq 100$
DuoPower ETA 8x40 with special screw	40	C12/15	150	130	70	$s_{min}=70$ for $c \geq 140$ $c_{min}=115$ for $s \geq 230$
		$\geq C16/20$		90	50	$s_{min}=50$ for $c \geq 100$ $c_{min}=80$ for $s \geq 160$
DuoPower ETA 10x50 with special screw	50	C12/15	150	115	70	$s_{min}=70$ for $c \geq 140$ $c_{min}=115$ for $s \geq 230$
		$\geq C16/20$		80	50	$s_{min}=50$ for $c \geq 100$ $c_{min}=80$ for $s \geq 160$

¹⁾ Intermediate values by linear interpolation.

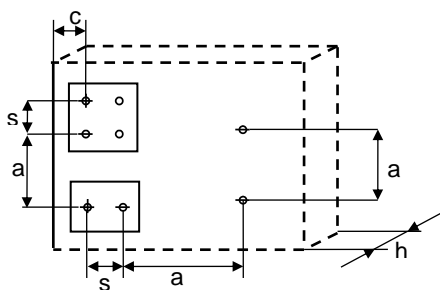

Fixing points with a spacing $a \leq s_{cr}$ are considered as a group with a maximum characteristic resistance $N_{Rk,p}$ according to Table C2.1. For a spacing $a > s_{cr}$ the anchors are considered as single anchors, each with a characteristic resistance $N_{Rk,p}$ according to Table C2.1.

Scheme of edge distances and spacing in concrete, base material group “a”

Figure not to scale

fischer universal plug DuoPower ETA

Intended use

Installation parameters
Minimum thickness of member, edge distances and spacing for use in concrete

Annex B 2

Appendix 9 / 14

Table B3.1: Minimum thickness of member, edge distances and spacing in solid and hollow or perforated brick masonry – base material group “b” and “c”

Anchor type			DuoPower ETA 10x50
Screw type		[-]	special screw
Minimum thickness of member ¹⁾	h_{min}	[mm]	115
Minimum spacing between anchor groups and / or single anchors	a_{min}	[mm]	250
Single anchor			
Minimum edge distance	c_{min}	[mm]	80
Anchor group			
Minimum spacing perpendicular to free edge	$s_{1,min}$	[mm]	50
Minimum spacing parallel to free edge	$s_{2,min}$	[mm]	50
Minimum edge distance	c_{min}	[mm]	80

¹⁾ Member thickness in accordance to Annex C 3.

Scheme of edge distances and spacing in solid and hollow or perforated brick masonry, base material group “b” and “c”

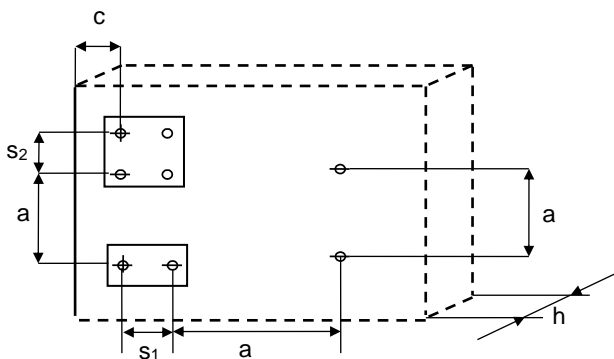

Figure not to scale

fischer universal plug DuoPower ETA

Intended use

Minimum thickness of member, edge distances and spacing for use in solid and hollow or perforated brick masonry

Annex B 3

Appendix 10 / 14

Installation instructions

The following pictures show a fastening by a timber fixture part, exemplarily on the substrate concrete for solid bricks and on the substrate perforated clay brick for hollow or perforated bricks – summary of all kind of base materials see Annex C 2 and C 3.

Concrete and solid bricks

hollow or perforated bricks

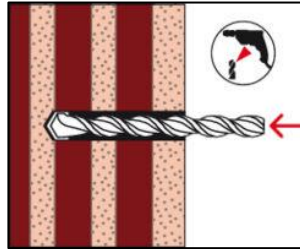
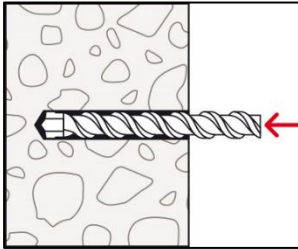

1. Drill the bore hole acc. to Table B 2.1 using the drilling method described in the corresponding Annex C 2 and C 3.

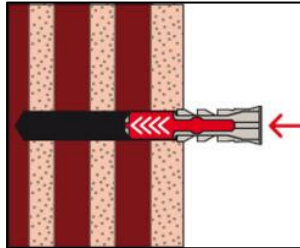
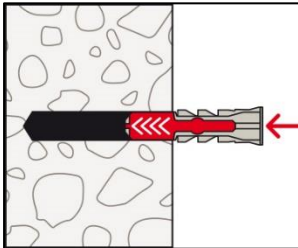

2. Insert anchor by using a hammer until the collar of the plastic sleeve is flush with the surface of the anchorage ground.

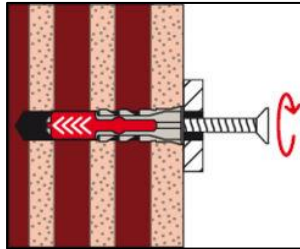
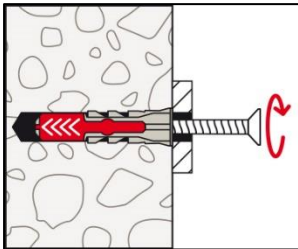

3. Attach fixture part and screw in the screw.
The anchor is correctly mounted, when the head of the screw fits tight on the surface and cannot be screwed-in easily any further.

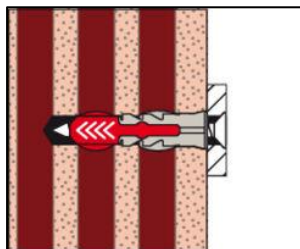
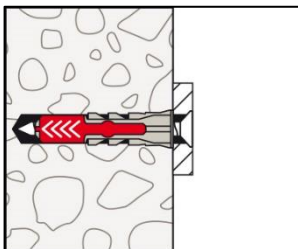

4. Correctly installed anchor.

fischer universal plug DuoPower ETA

Intended use
Installation instructions

Annex B 4
Appendix 11 / 14

Table C1.1: Characteristic resistance of the screw fischer PowerFast II

Failure of expansion element (fischer PowerFast II)	DuoPower ETA 8x40	
	galvanised steel	
Characteristic tension resistance $N_{Rk,s}$ [kN]	13,10	
Partial safety factor $\gamma_{Ms}^{1)}$ [-]	1,40	
Characteristic shear resistance $V_{Rk,s}$ [kN]	6,50	
Partial safety factor $\gamma_{Ms}^{1)}$ [-]	1,50	
Characteristic bending resistance of the screw		
Characteristic bending resistance $M_{Rk,s}$ [Nm]	8,20	
Partial safety factor $\gamma_{Ms}^{1)}$ [-]	1,50	

¹⁾ In absence of other national regulations.

Table C1.2: Characteristic resistance of the special screw

Failure of expansion element (special screw)	DuoPower ETA 8x40		DuoPower ETA 10x50	
	galvanised steel	stainless steel	galvanised steel	stainless steel
Characteristic tension resistance $N_{Rk,s}$ [kN]	14,80	14,30	21,70	21,70
Partial safety factor $\gamma_{Ms}^{1)}$ [-]	1,50	1,55	1,55	1,55
Characteristic shear resistance $V_{Rk,s}$ [kN]	7,40	7,10	10,80	10,80
Partial safety factor $\gamma_{Ms}^{1)}$ [-]	1,25	1,29	1,29	1,29
Characteristic bending resistance of the screw				
Characteristic bending resistance $M_{Rk,s}$ [Nm]	12,40	12,00	20,60	20,60
Partial safety factor $\gamma_{Ms}^{1)}$ [-]	1,25	1,29	1,29	1,29

¹⁾ In absence of other national regulations.

fischer universal plug DuoPower ETA

Performances

Characteristic resistance and characteristic bending resistance of the fischer PowerFast II and the special screw

Annex C 1

Appendix 12 / 14

Table C2.1: Characteristic resistance¹⁾ due to pull-out failure for use in concrete, base material group "a"²⁾

Pull-out failure (plastic sleeve)		DuoPower ETA 8x40		DuoPower ETA 10x50
Screw type		fischer PowerFast II	special screw	special screw
Embedment depth h_{nom} [mm]		40	40	50
Concrete C12/15				
Characteristic tension resistance 24/40 °C	$N_{RK,p}$ [kN]	0,21	1,40	1,40
Concrete \geq C16/20				
Characteristic tension resistance 24/40 °C	$N_{RK,p}$ [kN]	0,30	2,00	2,00
Partial safety factor	$\gamma_{Mc}^{3)}$ [-]	1,8		

¹⁾ Polymer failure $N_{RK,pol}$ and $V_{RK,pol}$ not decisively.

²⁾ Drilling method: hammer drilling.

³⁾ In absence of other national regulations.

Table C2.2: Displacements under tension and shear loading in concrete

Displacements under			Tension load ¹⁾		Shear load ¹⁾	
Anchor type	h_{nom} [mm]	F [kN]	δ_{NO} [mm]	$\delta_{N\infty}$ [mm]	δ_{vo} [mm]	$\delta_{v\infty}$ [mm]
DuoPower ETA 8x40 with fischer PowerFast II	40	0,08	0,01	0,02	0,07	0,10
		0,12	0,01	0,02	0,10	0,15
DuoPower ETA 8x40 with special screw	40	0,56	0,09	0,15	0,47	0,70
		0,79	0,13	0,15	0,66	0,99
DuoPower ETA 10x50 with special screw	50	0,56	0,07	0,21	0,32	0,48
		0,79	0,10	0,21	0,45	0,68

¹⁾ Intermediate values by linear interpolation.

Table C2.3: Displacements under tension and shear loading in solid and hollow or perforated bricks

Displacements under				Tension load ¹⁾		Shear load ¹⁾	
Anchor type	h_{nom} [mm]	Base material	F [kN]	δ_{NO} [mm]	$\delta_{N\infty}$ [mm]	δ_{vo} [mm]	$\delta_{v\infty}$ [mm]
DuoPower ETA 10x50 with special screw	50	Clay brick Mz; $\rho \geq 2,0$ as per EN 771-1	0,40	0,05	0,21	0,23	0,34
			0,71	0,09	0,21	0,41	0,61
		Calcium silicate solid brick KS; $\rho \geq 2,0$ as per EN 771-2	0,60	0,07	0,21	0,34	0,52
			0,86	0,10	0,21	0,49	0,74
		Perforated clay brick Hlz; $\rho \geq 1,0$ as per EN 771-1	0,17	0,06	0,21	0,10	0,15
	0,21	0,07	0,21	0,12	0,18		

¹⁾ Intermediate values by linear interpolation.

fischer universal plug DuoPower ETA	Annex C 2 Appendix 13 / 14
Performances Characteristic resistance for use in concrete Displacements under tension and shear loading in concrete and masonry	

Table C3.1: Characteristic resistance F_{Rk} in [kN] for use in solid and hollow or perforated bricks, base material group "b"⁽¹⁾ and "c"⁽²⁾

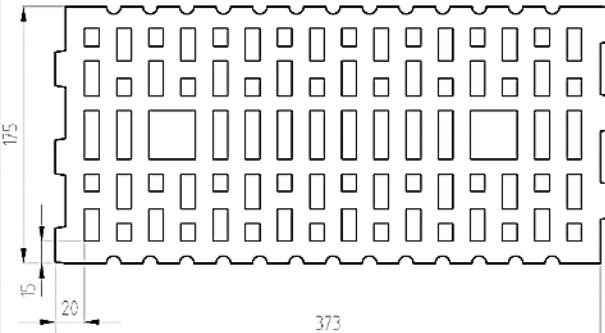
Base material; bulk density [kg/dm³] <i>[Supplier Title, country]</i> Geometry, DF or nominal size L x B x H [mm] and drilling method	Mean compressive strength as per EN 771/ Minimum compressive strength single brick ³⁾ [N/mm ²]	Characteristic resistance F_{Rk} [kN] Temperature range 24/40 °C
		DuoPower ETA 10x50 with special screw
		h_{nom} [mm] = 50
Clay brick Mz; $\rho \geq 2,0$ as per EN 771-1 <i>e.g. Helfer, DE</i> NF (240x115x71) Hammer drilling	12,5/10	1,40
	15/12	1,40
	20/16	2,00
	25/20	2,50
Calcium silicate solid brick KS; $\rho \geq 2,0$ as per EN 771-2 <i>e.g. Bayer, DE</i> 2 DF (240x115x113) Hammer drilling	10/8	2,10 / 2,45⁵⁾
	12,5/10	2,10 / 2,45⁵⁾
	15/12	2,10 / 2,45⁵⁾
	16,7/-	3,00 / 3,50⁵⁾
Perforated clay brick Hlz; $\rho \geq 1,2$ as per EN 771-1 <i>e.g. Schlagmann Poroton, DE</i> 	12,5/10	0,60
	15/12	0,75
9 DF (373x175x249) Rotary drilling		
Partial safety factor	$\gamma_{Mm}^{2)}$ [-]	2,5

- 1) Vertically perforation $\leq 15\%$; cross section reduced by perforation vertically to the resting area.
- 2) Vertically perforation $> 15\%$ and $\leq 50\%$, cross section reduced by perforation vertically to the resting area.
- 3) The compressive strength of the single brick must not be less than 80% of the mean compressive strength.
- 4) In absence of other national regulations.
- 5) Only valid for $C_{1min} \geq 110$ mm and $C_{2min} \geq 165$ mm (C_{1min} can be perpendicular as well as parallel to the vertical edge; $C_{1min} \perp C_{2min}$).

fischer universal plug DuoPower ETA

Performances

Characteristic resistance for use in solid and hollow or perforated bricks

Annex C 3

Appendix 14 / 14