

## LEISTUNGSERKLÄRUNG

### DoP 0346

für fischer TermoZ CS II 8 und fischer TermoZ CS II 8 DT 110 V (Kunststoffdübel für die Verwendung in Beton und Mauerwerk)

DE

1. Eindeutiger Kenncode des Produkttyps: DoP 0346
2. Verwendungszweck(e): Schraubdübel zur Befestigung von außenseitigen Wärmedämm-Verbundsystemen (WDVS) mit Putzschicht in Beton, Mauerwerk, haufwerksporigem Leichtbeton und Porenbeton und für die Befestigung in Deckenuntersichten aus Beton, siehe Anhang, insbesondere die Anhänge B1- B4.
3. Hersteller: fischerwerke GmbH & Co. KG, Klaus-Fischer-Str. 1, 72178 Waldachtal, Deutschland
4. Bevollmächtigter: -
5. AVCP - System/e: 2+
6. Europäisches Bewertungsdokument: EAD 330196-01-0604-v01  
Europäische Technische Bewertung: ETA-14/0372; 2023-11-03  
Technische Bewertungsstelle: ETA-Danmark A/S  
Notifizierte Stelle(n): 2873 TU Darmstadt
7. Erklärte Leistung(en):  
**Sicherheit bei der Nutzung (BWR 4)**  
**Charakteristische Tragfähigkeit der Dübel pro Panel:**  
Charakteristischer Widerstand bei Kurzzeit Zugbelastung: Anhang C5  
Charakteristischer Widerstand bei Langzeit-Zugbelastung: Anhang C5  
Minimaler Randabstand: Anhang B3  
Minimaler Achsabstand: Anhang B3  
  
**Verschiebungen:**  
Zuglast: Anhang C5  
Kurzzeit-Verschiebungen: Anhang C5  
Langzeit-Verschiebungen: Anhang C5  
  
**Tellersteifigkeit:**  
Durchmesser Dübelteller: Anhang C3  
Tragfähigkeit des Dübeltellers: Anhang C3  
Steifigkeit Dübelteller: Anhang C3  
  
**Charakteristische Durchzugskraft für ein Panel:**  
Mindeststärke der Isolierung: NPD  
Kurzzeitiger charakteristischer Durchzugswiderstand: NPD  
Langzeitiger Durchzugswiderstand: NPD  
  
**Energieeinsparung und Wärmeschutz (BWR 6)**  
**Wärmedurchlässigkeit:**  
Punktuelle Wärmeübertragung des Dübels: Anhang C3  
Dämmschichtdicke WDVS: Anhang C3
8. Angemessene Technische Dokumentation und/oder Spezifische Technische Dokumentation: -

Die Leistung des vorstehenden Produkts entspricht der erklärten Leistung/den erklärten Leistungen. Für die Erstellung der Leistungserklärung im Einklang mit der Verordnung (EU) Nr. 305/2011 ist allein der obengenannte Hersteller verantwortlich.

Unterszeichnet für den Hersteller und im Namen des Herstellers von:



Dr.-Ing. Oliver Geibig, Geschäftsführer Business Units & Engineering  
Tumlingen, 2023-11-17



Jürgen Grün, Geschäftsführer Chemie & Qualität

Diese Leistungserklärung wurde in mehreren Sprachen erstellt. Für alle Streitigkeiten, die sich aus der Auslegung ergeben, ist die Fassung in englischer Sprache maßgeblich.

Der Anhang enthält freiwillige und ergänzende Informationen in englischer Sprache, die über die (sprachneutral festgelegten) gesetzlichen Anforderungen hinausgehen.

Translation guidance Essential Characteristics and Performance Parameters for Annexes  
**Übersetzungshilfe der Wesentlichen Merkmale und Leistungsparameter für Annexes**  
 Safety in use (BWR 4)

<b>Sicherheit bei der Nutzung (BWR 4)</b>		
2: Characteristic load bearing capacity of anchors per panel: <b>Charakteristische Tragfähigkeit der Dübel pro Panel:</b>		
2.1	Characteristic resistance under short-term tension load: <b>Charakteristischer Widerstand bei Kurzzeit Zugbelastung:</b>	$N_{Rk,panel,sh}$ [kN/m <sup>2</sup> ]
2.2	Characteristic resistance under long-term tension load: <b>Charakteristischer Widerstand bei Langzeit-Zugbelastung:</b>	$N_{Rk,panel,lg}$ [kN/m <sup>2</sup> ]
2.3	Minimum edge distance: <b>Minimaler Randabstand:</b>	$c_{min}$ [mm]
2.4	Minimum spacing: <b>Minimaler Achsabstand:</b>	$s_{min}$ [mm]
3: Displacements: <b>Verschiebungen:</b>		
3.1	Tension load: <b>Zuglast:</b>	$N$ [kN]
3.2	Short-term displacements: <b>Kurzzeit-Verschiebungen:</b>	$\delta_{sh}$ [mm]
3.3	Long-term displacements: <b>Langzeit-Verschiebungen:</b>	$\delta_{lg}$ [mm]
4: Plate stiffness: <b>Tellersteifigkeit:</b>		
4.1	Diameter of the anchor insulation fixing element: <b>Durchmesser Dübelteller:</b>	[mm]
4.2	Load resistance of the anchor insulation fixing element: <b>Tragfähigkeit des Dübeltellers:</b>	[kN]
4.3	Plate stiffness: <b>Steifigkeit Dübelteller:</b>	[kN/mm]
5: Characteristic pull-through capacity for a panel: <b>Charakteristische Durchzugskraft für ein Panel:</b>		
5.1	Minimum thickness of insulation: <b>Mindeststärke der Isolierung:</b>	[mm]
5.2	Short-term characteristic pull-through resistance: <b>Kurzzeitiger charakteristischer Durchzugswiderstand:</b>	$R_{panel,sh}$ [kN/m <sup>2</sup> ]
5.3	Long-term pull-through resistance: <b>Langzeitiger Durchzugswiderstand:</b>	$R_{panel,lg}$ [kN/m <sup>2</sup> ]
Energy economy and heat retention (BWR 6) <b>Energieeinsparung und Wärmeschutz (BWR 6)</b>		
6: Thermal transmittance: <b>Wärmedurchlässigkeit:</b>		
6.1	Point thermal transmittance of an anchor: <b>Punktueller Wärmeübertragung des Dübels:</b>	$\chi$ [W/K]
6.2	Insulating layer thickness of the ETICS: <b>Dämmschichtdicke WDVS:</b>	$h_D$ [mm]

## **II SPECIFIC PART OF THE EUROPEAN TECHNICAL ASSESSMENT**

### **1 Technical description of product**

The screwed-in anchors fischer TermoZ CS II 8 and fischer TermoZ CS II 8 DT 110 V are used for fixing of external thermal insulation composite systems (ETICS). The fischer TermoZ CS II 8 consists of an anchor sleeve made of polypropylene with a diameter of 8 mm and an insulation plate made of glass-fiber reinforced polyamide with a diameter of 60 mm. The fischer TermoZ CS II 8 DT 110 V consists of an anchor sleeve made of polypropylene with a diameter of 8 mm and an insulation plate made of glass-fiber reinforced polyamide with a diameter of 110 mm. The color of the anchor sleeve is grey. The special compound screw is made of galvanised steel and glass-fiber reinforced polyamide. The anchor is expanded by screwing the screw into the sleeve. It is possible to install the anchor flush or countersunk mounted to the surface of the insulation.

The product description is given in Annex A.

### **2 Specification of the intended use in accordance with the applicable European Assessment Document (hereinafter EAD)**

The performances given in Section 3 are only valid if the anchor is used in compliance with the specifications and conditions given in Annex B1 to B3.

The provisions made in this European Technical Assessment are based on an assumed intended working life of the anchor of 25 years.

The indications given on the working life cannot be interpreted as a guarantee given by the producer or Assessment Body, but are to be regarded only as a means for choosing the right products in relation to the expected economically reasonable working life of the works.

### **3 Performance of the product and references to the methods used for its assessment**

#### **3.1 Characteristics of product**

**Safety in case of fire (BWR 2):**

No Performance Assessed.

**Safety in use (BWR4):**

The essential characteristics are detailed in Annex B3 and Annex C1 to C5.

Characteristic pull-through capacity for a panel:  
No performance assessed.

Note. The characteristic pull-through capacity for a panel depends on the relevant panel and is to be assessed for the full ETICS kit taking into account the relevant insulation product.

**Energy economy and heat retention (BWR6):**

The essential characteristics are detailed in the Annex C3.

Other Basic Requirements are not relevant.

**General aspects**

The verification of durability is part of testing of the essential characteristics. Durability is only ensured if the specifications of intended use according to Annex B are taken into account.

#### **3.2 Methods of assessment**

The assessment of fitness of the anchor for the intended use in relation to the requirements for mechanical resistance and stability and safety in use in the sense of the Basic Requirements 4 has been made in accordance with the EAD 330196-01-0604 Plastic anchors made of virgin or non-virgin material for fixing of external thermal insulation composite systems with rendering as well as EAD 330196-01-0604-v01 - Screwed-in plastic anchors for fixing of external thermal insulation composite systems (ETICS) on bottom side of ceilings.

## **4 Assessment and verification of constancy of performance (AVCP)**

### **4.1 AVCP system**

According to the decision 97/463/EC of the European Commission, the system(s) of assessment and verification of constancy of performance (see Annex V to Regulation (EU) No 305/2011) is 2+.

## TermoZ CS II 8

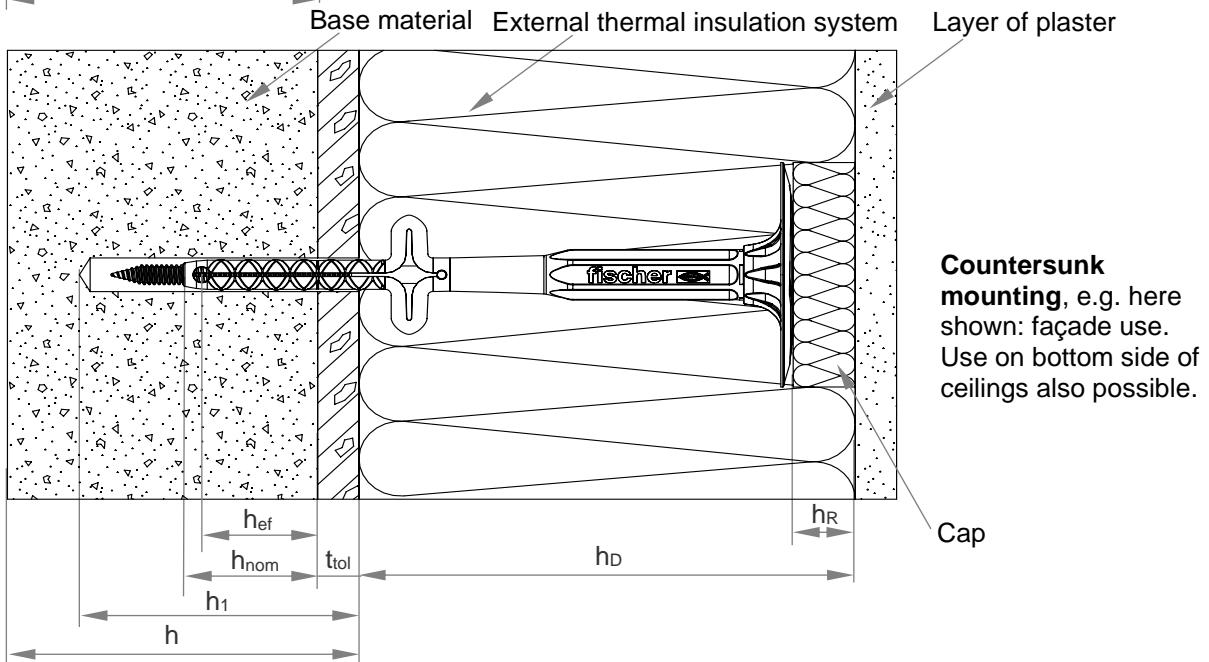
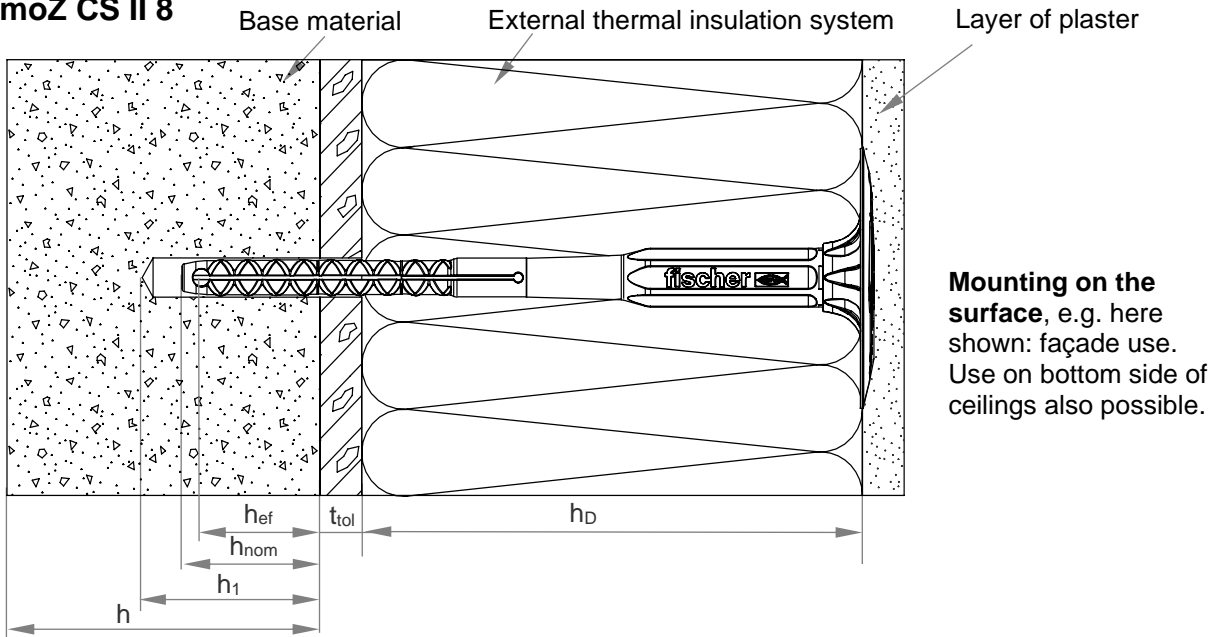

### Legend

- $h_{nom}$  = Overall plastic anchor embedment depth in the base material
- $h_{ef}$  = Effective anchorage depth in the base material
- $h_1$  = Depth of drilled hole to deepest point
- $h$  = Thickness of member (wall)
- $h_D$  = Thickness of insulation material
- $t_{tol}$  = Thickness of equalising layer and / or non-load-bearing coating
- $h_R$  = Thickness of cap

Figures not to scale

### fischer TermoZ CS II 8 and fischer TermoZ CS II 8 DT 110 V

#### Product description

Installed anchor TermoZ CS II 8 for façade use and for use on bottom side of ceilings

Annex A1

# TermoZ CS II 8 DT 110 V

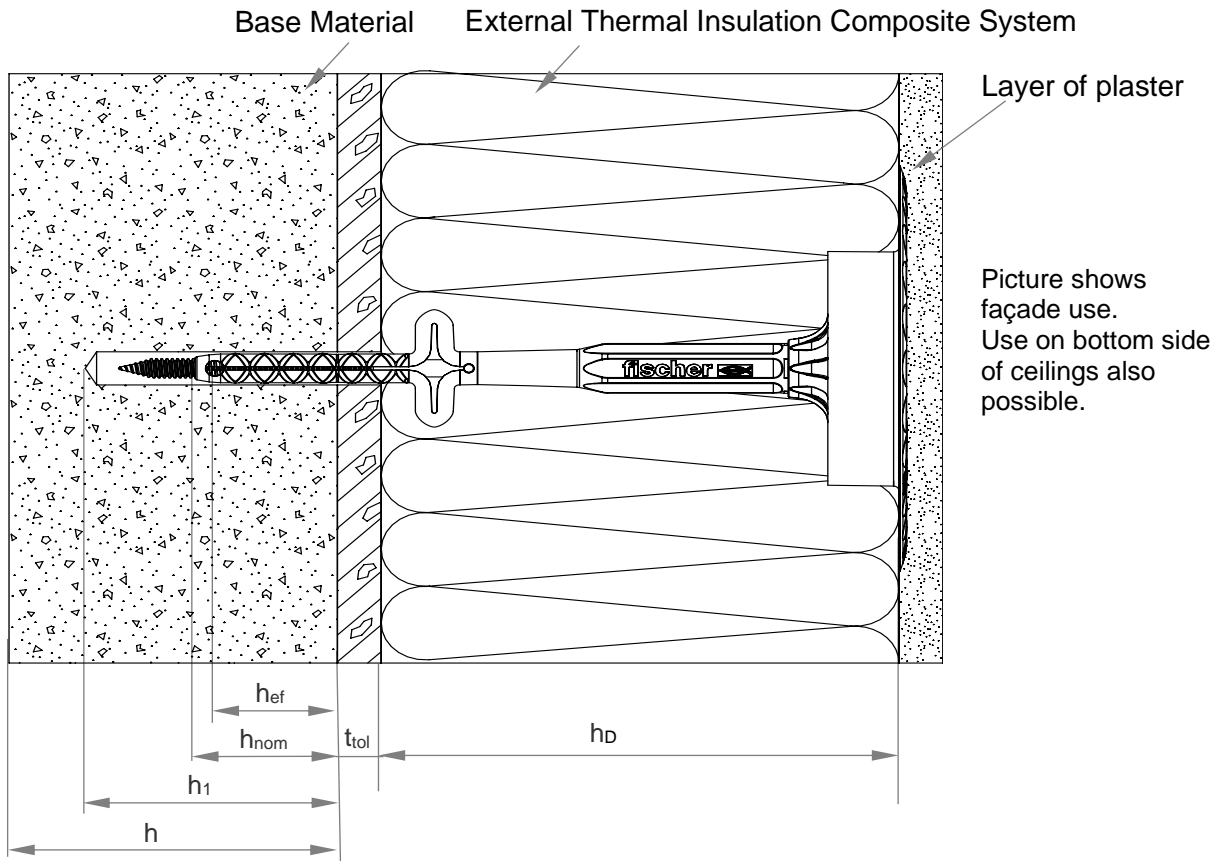

## Legend

- $h_{nom}$  = Overall plastic anchor embedment depth in the base material
- $h_{ef}$  = Effective anchorage depth in the base material
- $h_1$  = Depth of drilled hole to deepest point
- $h$  = Thickness of member (wall)
- $h_D$  = Thickness of insulation material
- $t_{tol}$  = Thickness of equalising layer and / or non-load-bearing coating

Figure not to scale

### fischer TermoZ CS II 8 and fischer TermoZ CS II 8 DT 110 V

#### Product description

Installed anchor TermoZ CS II 8 DT 110 V 8 for façade use and for use on bottom side of ceilings

### Annex A2

**Anchor sleeve / Specific screw for TermoZ CS II 8/95-255**

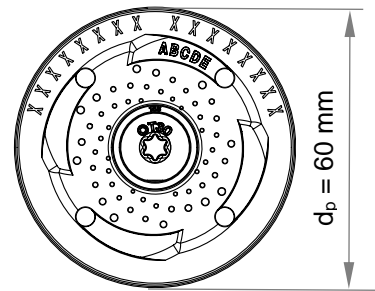
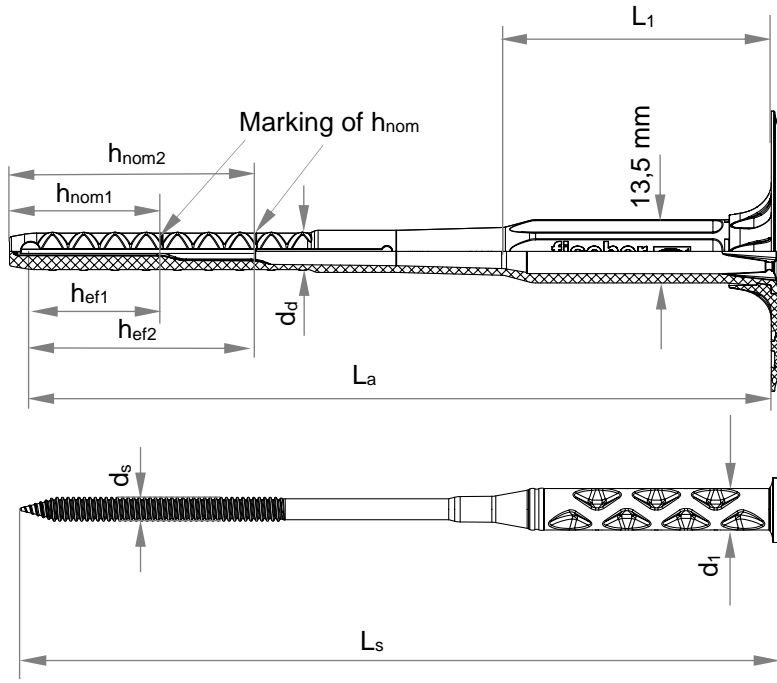

TermoZ CS II 8/95-255  
 $95 \text{ mm} \leq L_a \leq 255 \text{ mm}$   
 Thickness of insulation material:  
 $h_D = (L_a - h_{ef} - t_{tol})$

**Anchor sleeve / Specific screw for TermoZ CS II 8/275-455**

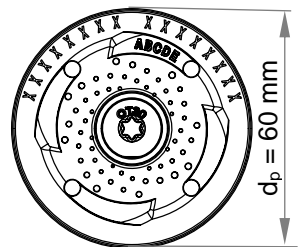
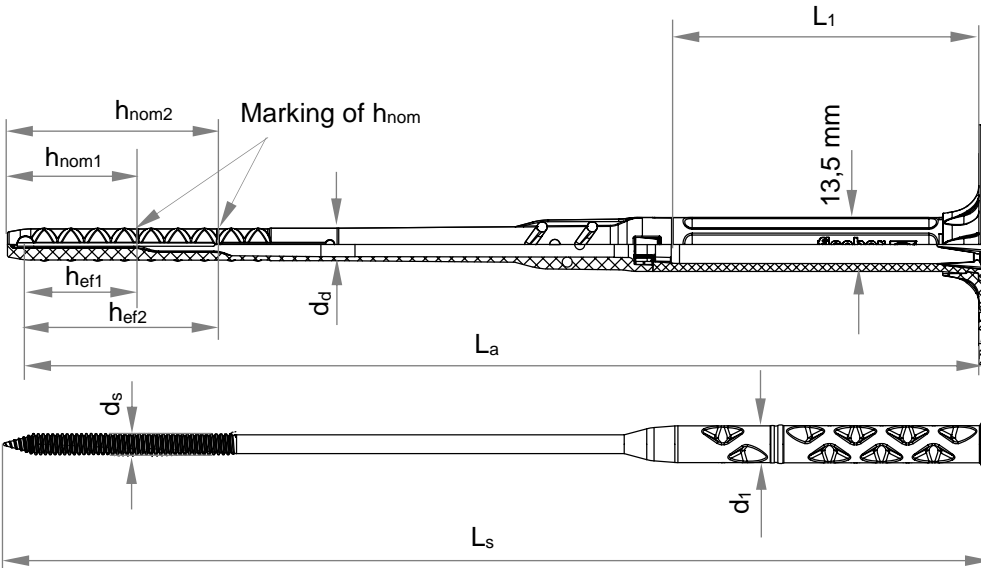

TermoZ CS II 8/275-455  
 $275 \text{ mm} \leq L_a \leq 455 \text{ mm}$   
 Thickness of insulation material:  
 $h_D = (L_a - h_{ef} - t_{tol})$

Figures not to scale

**fischer TermoZ CS II 8 and fischer TermoZ CS II 8 DT 110 V**

**Product description**  
 Dimensions TermoZ CS II 8

**Annex A3**



### TermoZ CS II 8/115-255 DT 110 V

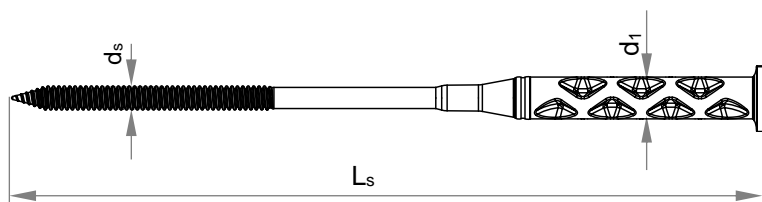
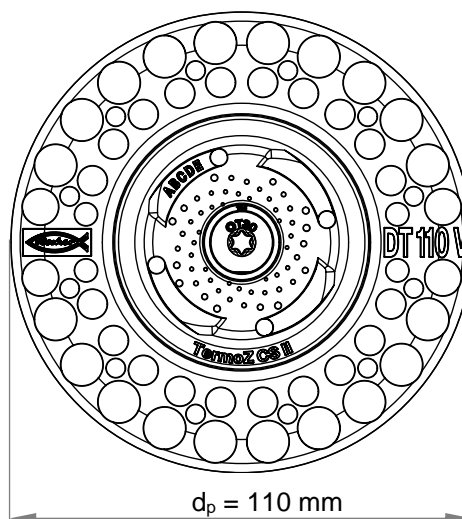
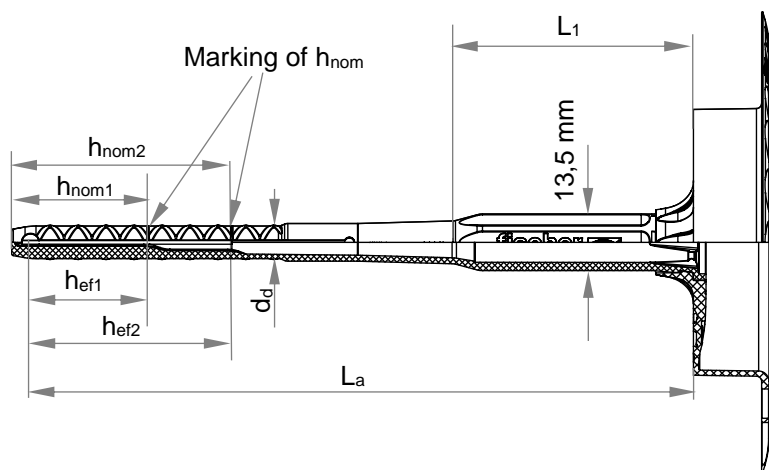

TermoZ CS II 8/115-255 DT 110 V:  
 $115 \text{ mm} \leq L_a \leq 255 \text{ mm}$   
 Thickness of insulation material:  
 $h_D = (L_a - h_{ef} - t_{tol})$

### TermoZ CS II 8/275-455 DT 110 V

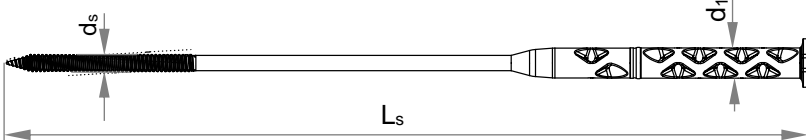
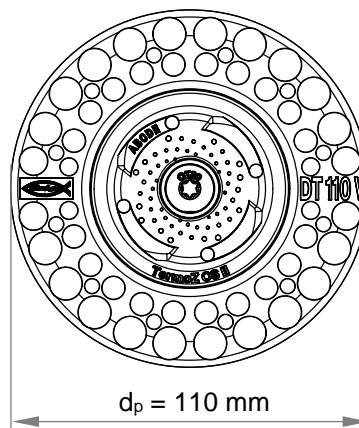
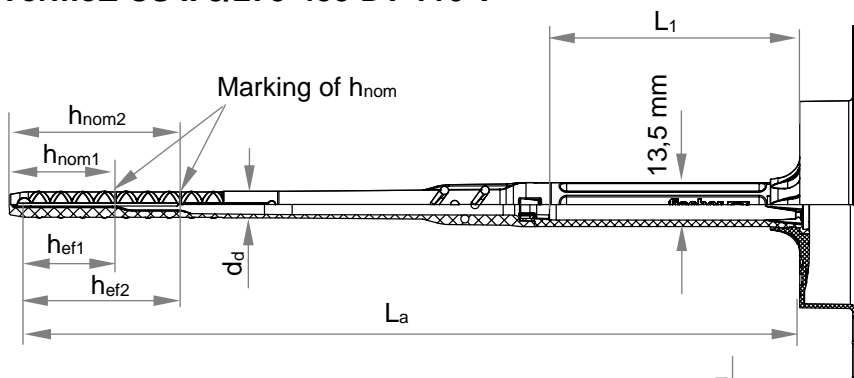

TermoZ CS II 8/275-455 DT 110 V:  
 $275 \text{ mm} \leq L_a \leq 455 \text{ mm}$   
 Thickness of insulation material:  
 $h_D = (L_a - h_{ef} - t_{tol})$

Figures not to scale

fischer TermoZ CS II 8 and fischer TermoZ CS II 8 DT 110 V

**Product description**  
 Dimensions TermoZ CS II 8 DT 110 V

**Annex A4**

**Setting tool with SDS adapter or hexagonal adapter available**

Countersunk setting of anchor TermoZ CS II 8  
and setting of TermoZ CS II 8 DT 110 V  
**Note:** not possible for TermoZ CS II 8/95

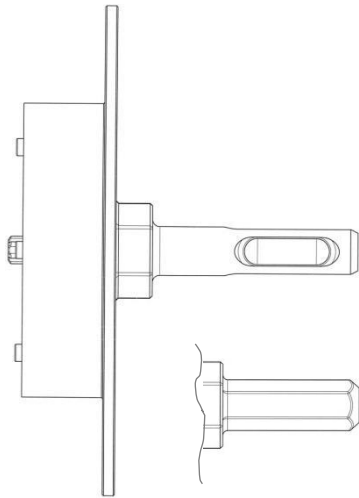

Optional: plain surface setting  
**Note:** not possible for  
TermoZ CS II 8 DT 110 V

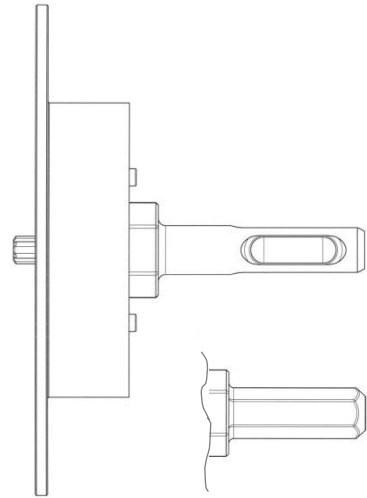

**Cap**

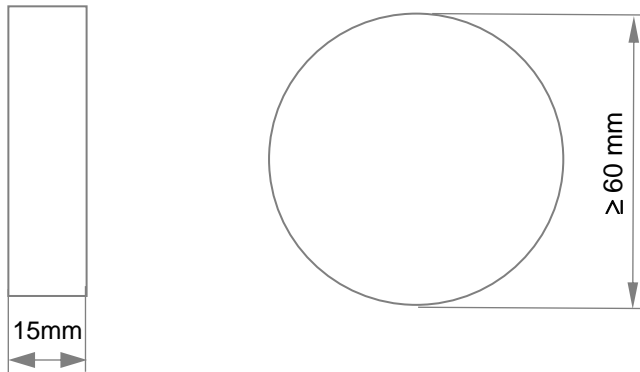



Figures not to scale

**fischer TermoZ CS II 8 and fischer TermoZ CS II 8 DT 110 V**

**Product description**  
Setting tool and dimensions of cap

**Annex A5**

<b>Table A6.1: Marking of plates</b>	
	<b>Designation</b>
Name of anchor	<b>TermoZ CS II 8</b>
Example	TermoZ CS II ABCDE,  (optional), CE  (optional), Ø 8 (optional) xxxxx additional marks possible
Name of anchor	<b>TermoZ CS II 8 DT 110 V</b>
Example	TermoZ CS II ABCDE  DT 110 V

**Table A6.2: Dimensions of TermoZ CS II 8**

Anchor type	Anchor sleeve			Shaft		Specific screw		
	d <sub>d</sub>	h <sub>nom</sub>	h <sub>ef</sub>	L <sub>a</sub>	L <sub>1</sub>	d <sub>s</sub>	l <sub>s</sub>	d <sub>1</sub>
TermoZ CS II 8/95-115	8	32,5	25	95-115	42	5,4	L <sub>a</sub> + 10	9,5
TermoZ CS II 8/135-255		32,5	25	135-255	52			
		52,5	45					
TermoZ CS II 8/275-295		32,5	25	275-295	76			
		52,5	45					
TermoZ CS II 8/315-375		32,5	25	315-375	156			
		52,5	45					
TermoZ CS II 8/395-455		32,5	25	395-455	236			
		52,5	45					

**Table A6.3: Dimensions of TermoZ CS II 8 DT 110 V**

Anchor type	Anchor sleeve			Shaft		Specific screw		
	d <sub>d</sub>	h <sub>nom</sub>	h <sub>ef</sub>	L <sub>a</sub>	L <sub>1</sub>	d <sub>s</sub>	l <sub>s</sub>	d <sub>1</sub>
TermoZ CS II 8/115 DT 110 V	8	32,5	25	95-115	42	5,4	L <sub>a</sub> + 10	9,5
TermoZ CS II 8/135-255 DT110 V		32,5	25	135-255	52			
		52,5	45					
TermoZ CS II 8/275-295 DT 110 V		32,5	25	275-295	76			
		52,5	45					
TermoZ CS II 8/315-375 DT 110 V		32,5	25	315-375	156			
		52,5	45					
TermoZ CS II 8/395-455 DT 110 V		32,5	25	395-455	236			
		52,5	45					

All dimensions in [mm]

**fischer TermoZ CS II 8 and fischer TermoZ CS II 8 DT 110 V**

**Product description**  
Marking of plates  
Dimensions of anchors

**Annex A6**

<b>Table A7.1: Materials</b>	
<b>Designation</b>	<b>Material</b>
Anchor sleeve / shaft	PP, colour: grey
Specific compound screw TermoZ CS II 8 / TermoZ CS II 8 DT 110 V	PA6, GF with galvanised steel Zn5/Ag or Zn5/An as per EN ISO 4042
Cap	Soft wood fibre; polystyrene; mineral wool
Anchor plate / Slip-on plate	PA6, GF colour: grey, blue, green, orange, red, yellow, black, mocca-latte

**Drawing of the slip-on plate (e.g. DT 140)**

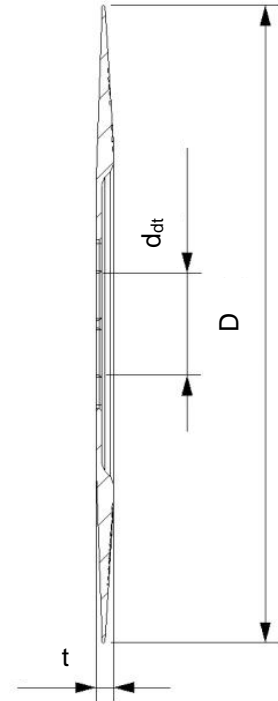
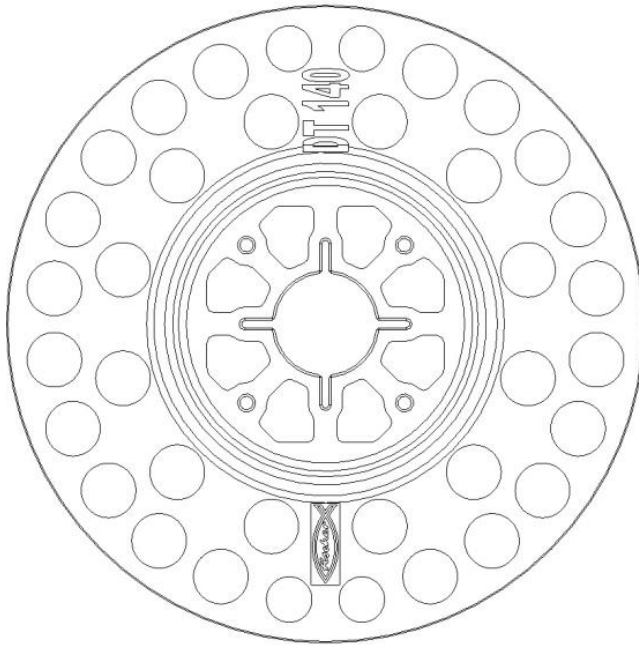

**Table A7.2: Slip-on plates, diameters**

<b>Slip-on plate</b>	<b>D [mm]</b>	<b>d<sub>dt</sub> [mm]</b>	<b>t [mm]</b>
DT 90 / DT 110 / DT 140	90 / 110 / 140	22,5	3,9

Figures not to scale

**fischer TermoZ CS II 8 and fischer TermoZ CS II 8 DT 110 V**

**Product description**  
Materials and dimensions of slip-on plates

**Annex A7**

## Specifications of intended use

### Anchorage subject to:

- The anchor may be used for transmission of wind suction loads.
- Additionally the anchor may be used for transmission of dead loads of thermal insulation panels with or without rendering on bottom side of ceilings.
- Anchors may be used for fixing of thermal insulation panels with or without rendering on bottom side of ceilings in concrete with or without supplementary adhesive. The product can only be used for ETICS with the following parameters:
  - for use of insulation panels with a tensile resistance equal and more than 80 kPa - adhesion of ETICS's rendering to the insulation panel shall be at least 80 kPa.
  - for use of insulation panels with a tensile resistance less than 80 kPa - adhesion of ETICS's rendering to the insulation panel shall be at least as high as nominal tensile resistance of a panel.

### Base materials:

- Normal weight concrete without fibres  $\geq$  C12/15 (base material group "A") as per EN 206:2013+A1:2016, see Annex C1.

Note: only for use on bottom side of ceilings:

Reinforced or unreinforced concrete without fibres, strength  $\geq$  C12/15 (base material group "A") as per EN 206, see Annex C5.

- Solid masonry (base material group "B"), as per EN 771-1:2011+A1:2015, EN 771-2:2011+A1:2015, EN 771-3:2011+A1:2015, see Annex C1.
- Hollow or perforated masonry (base material group "C"), as per EN 771-1:2011+A1:2015, EN 771-2:2011+A1:2015 or EN 771-3:2011+A1:2015, see Annex C1 and C2.
- Lightweight aggregate concrete (base material group "D"), as per EN 1520:2011 / EN 771-3:2011+A1:2015, see Annex C2.
- Autoclaved aerated concrete (base material group "E"), as per EN 771-4:2011+A1:2015, see Annex C2.
- For other comparable materials of the base material groups "A", "B", "C", "D" and "E" the characteristic resistance of the anchor may be determined by job site tests according to EOTA Technical Report TR 051 Edition April 2018.

### Temperature Range:

- 0 °C to + 40 °C (max. short term temperature + 40 °C and max. long term temperature + 24 °C) of the base material.

### Design:

- The anchorages are designed under the responsibility of an engineer experienced in anchorages and masonry work with the partial factors  $\gamma_M = 2,0$  und  $\gamma_F = 1,5$  if there are no other national regulations.
- For use on bottom side of ceilings in concrete, anchorages are designed with partial safety factors  $\gamma_{EPS} = 1,5$  for EPS insulation panels and  $\gamma_{MW} = 2,0$  for mineral wool panels, if there are no other national regulations.
- Verifiable calculation notes and drawings are prepared taking account of the loads to be anchored. The position of the anchors is indicated on the design drawings.
- Fasteners are only to be used for multiple fixings of thermal insulation composite systems.
- For use on bottom side of ceilings in concrete at least 4 anchors per m<sup>2</sup> shall be used in insulation panels in absence of other national requirements.

**fischer TermoZ CS II 8 and fischer TermoZ CS II 8 DT 110 V**

**Intended use**  
Specifications

**Annex B1**

**Installation:**

- Drilling method see Annex C1, C2 and C5.
- Anchor installation carried out by appropriately qualified personnel and under the supervision of the person responsible for technical matters on the site.
- Installation temperature of the anchor from 0 °C to + 40 °C.
- Exposure to UV due to solar radiation of the anchor not protected by rendering  $\leq 6$  weeks.
- The anchors have to be arranged depending on the used insulation material, the ETIC system and/or the system approval.
- For application on bottom side ceilings, it is possible to use the anchors without rendering or applying under UV protection longer than 6 weeks. If the anchors are not protected by rendering for the lifetime, the anchors must be covered by stainless steel or carbon steel with coating complying with corrosion resistance class 3 according to EN ISO 9223 or EN ISO 12944-2. Other materials are suitable if the evidence of non-UV transmission is provided. Yearly checks are required and damaged covers have to be replaced.

**fischer TermoZ CS II 8 and fischer TermoZ CS II 8 DT 110 V****Intended use**  
Specifications**Annex B2**

**Table B3.1: Installation parameters for base material groups “A” concrete, “B” solid bricks, “C” hollow or perforated bricks, “D” lightweight aggregate concrete and “E” autoclaved aerated concrete**

Anchor type		TermoZ CS II 8/95-455 TermoZ CS II 8/115-455 DT 110 V	
		flush	countersunk <sup>1)</sup>
Nominal drill hole diameter	$d_0 =$ [mm]	8	8
Cutting diameter of drill bit	$d_{cut} \leq$ [mm]	8,45	8,45
Depth of drill hole to deepest point	$h_1 \geq$ [mm]	40	55
Overall plastic anchor embedment depth in the base material	$h_{nom} \geq$ [mm]	32,5	32,5
Effective anchorage depth in the base material	$h_{ef} \geq$ [mm]	25	25

<sup>1)</sup> Not possible for TermoZ CS II 8/95.

**Table B3.2: Installation parameters alternative option for base material group “E” for higher loads**

Anchor type		TermoZ CS II 8/135-455 TermoZ CS II 8/135-455 DT 110 V	
		flush	countersunk
Nominal drill hole diameter	$d_0 =$ [mm]	8	8
Cutting diameter of drill bit	$d_{cut} \leq$ [mm]	8,45	8,45
Depth of drill hole to deepest point	$h_1 \geq$ [mm]	60	75
Overall plastic anchor embedment depth in the base material	$h_{nom} \geq$ [mm]	52,5	52,5
Effective anchorage depth in the base material	$h_{ef} \geq$ [mm]	45	45

**Table B3.3: Minimum thickness of member, edge distances and spacing in all regulated base material groups**

Anchor type		TermoZ CS II 8/95-455 TermoZ CS II 8/115-455 DT 110 V
Minimum thickness of member	$h_{min} =$ [mm]	100
Minimum spacing	$s_{min} =$ [mm]	100
Minimum edge distance	$c_{min} =$ [mm]	100

**Scheme of edge distances and spacing**  
for base material group “A”, concrete, group “B” solid bricks, group “C” hollow or perforated masonry, group “d” lightweight aggregate concrete, group “E” autoclaved aerated concrete

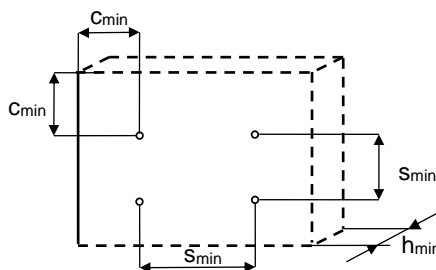

Figure not to scale

**fischer TermoZ CS II 8 and fischer TermoZ CS II 8 DT 110 V**

**Intended use**

Installation parameters depending on the base material groups  
Minimum thickness of member, edge distances and spacings

**Annex B3**

## Installation instruction

**Standard setting of TermoZ CS II 8 (plain surface setting) without setting tool / exemplarily illustrated installation in the ceiling – installation in the wall / façade is also possible**

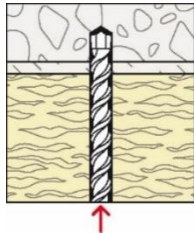

1. Drill hole by corresponding drilling method

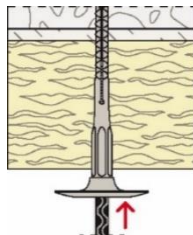

2. Insert anchor manually

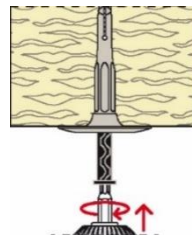

3. Set anchor by machine

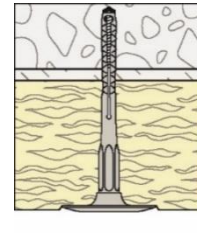

4. Correctly installed anchor

**Setting of TermoZ CS II 8 (plain surface setting) by setting tool / exemplarily illustrated installation in the wall / façade – installation in the ceiling is also possible**

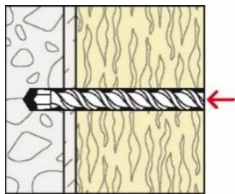

1. Drill hole by corresponding drilling method

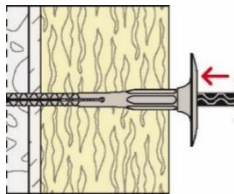

2. Insert anchor manually

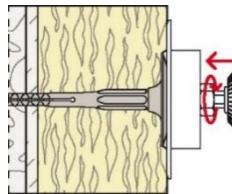

3. Set anchor by setting tool with the machine

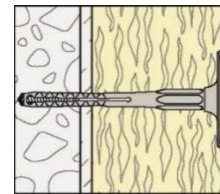

4. Correctly installed anchor

**Setting of TermoZ CS II 8 (countersunk setting) by setting tool / exemplarily illustrated installation in the wall / façade – installation in the ceiling is also possible**

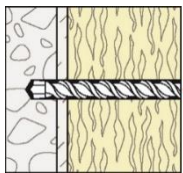

1. Drill hole by corresponding drilling method

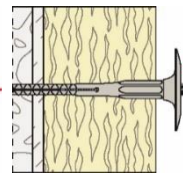

2. Insert anchor manually

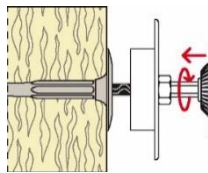

3. Put on setting tool

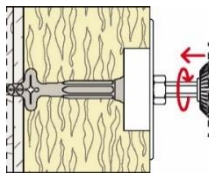

4. Set anchor by setting tool with the machine

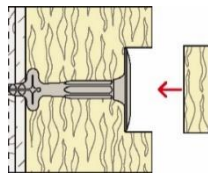

5. Put on cap

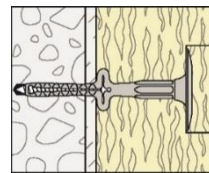

6. Correctly installed anchor

**Setting of TermoZ CS II 8 DT 110 V by setting tool / exemplarily illustrated installation in the wall / façade – installation in the ceiling is also possible**

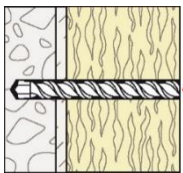

1. Drill hole by corresponding drilling method

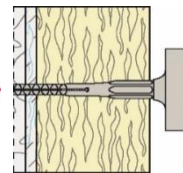

2. Insert anchor manually

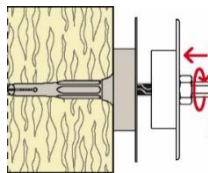

3. Put on setting tool

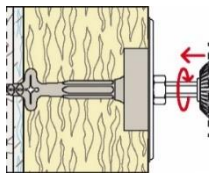

4. Set anchor by setting tool with the machine

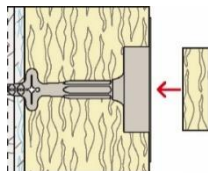

5. Put on cap

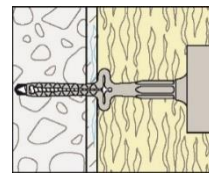

6. Correctly installed anchor

**fischer TermoZ CS II 8 and fischer TermoZ CS II 8 DT 110 V**

### Intended use

Installation instruction for use in façade and for use on bottom side of ceilings

**Annex B4**



<b>Table C1.1: Characteristic resistance to tension loads <math>N_{Rk}</math> for single anchor TermoZ CS II 8 and TermoZ CS II 8 DT 110 V for façade use</b>						
<b>Base material</b>	<b>Group</b>	<b>Bulk density</b>  $\rho$ <b>[kg/dm<sup>3</sup>]</b>	<b>Mean compressive strength / minimum compressive strength single brick according to EN 771<sup>1)</sup> [N/mm<sup>2</sup>]</b>	<b>Remarks</b>	<b>Drilling method<sup>2)</sup></b>	<b>Characteristic resistance to tension loads</b>  <b><math>N_{Rk}</math> [kN]</b>
Concrete ≥ C12/15 to ≤ C50/60, as per EN 206:2013+A1:2016	A	-	-	-	H	<b>1,50</b>
Weather resistant concrete shell ≥ C20/25 as per EN 206:2013+A1:2016	A	-	-	Thickness $h \geq 40$ mm.	H	<b>1,50</b>
Solid clay brick, Mz, as per EN 771-1:2011+A1:2015	B <sup>3)</sup>	≥ 1,8	≥ 25/20	-	H	<b>1,50</b>
Calcium silicate solid brick, KS, as per EN 771-2:2011+A1:2015	B <sup>3)</sup>	≥ 1,4	≥ 15/12	-	H	<b>1,50</b>
			≥ 25/20			
Solid lightweight concrete block, Vbl, as per EN 771-3:2011+A1:2015	B <sup>3)</sup>	≥ 1,4	≥ 10/8	-	H	<b>1,20</b>
Solid concrete block, Vbn, as per EN 771-3:2011+A1:2015	B <sup>3)</sup>	≥ 2,0	≥ 15/12	-	H	<b>1,50</b>
			≥ 25/20			
<sup>1)</sup> The compressive strength of the single brick must not be less than 80% of the mean compressive strength. <sup>2)</sup> H = Hammer drilling, R = Rotary drilling. <sup>3)</sup> Vertically perforation ≤ 15%; cross section reduced by perforation vertically to the resting area.						
<b>fischer TermoZ CS II 8 and fischer TermoZ CS II 8 DT 110 V</b>					<b>Annex C1</b>	
<b>Performances</b> Characteristic resistance to tension loads						

**Table C2.1: Characteristic resistance to tension loads  $N_{Rk}$  for single anchor  
TermoZ CS II 8 and TermoZ CS II 8 DT 110 V for façade use**

Base material	Group	Bulk density $\rho$ [kg/dm <sup>3</sup> ]	Mean compressive strength / minimum compressive strength single brick according to EN 771 <sup>1)</sup> [N/mm <sup>2</sup> ]	Remarks	Drilling method <sup>2)</sup>	Characteristic resistance to tension loads  $N_{Rk}$ [kN]
Vertically perforated clay brick, Hlz, as per EN 771-1:2011+A1:2015	C <sup>3)</sup>	≥ 0,9	≥ 15/12	Exterior web thickness ≥ 12 mm.	R	<b>1,00</b>
			≥ 15/12		H	<b>0,65</b>
		≥ 1,6	≥ 60/48		R	<b>1,50</b>
			≥ 60/48		H	<b>1,50</b>
Hollow calcium silicate brick, KSL, as per EN 771-2:2011+A1:2015	C <sup>3)</sup>	≥ 1,4	≥ 15/12	Exterior web thickness ≥ 23 mm.	H	<b>1,50</b>
Hollow brick lightweight concrete, Hbl, as per EN 771-3:2011+A1:2015	C <sup>3)</sup>	≥ 0,9	≥ 5/4	Exterior web thickness ≥ 16 mm.	H	<b>0,50</b>
Hollow brick concrete, Hbn, as per EN 771-3:2011+A1:2015	C <sup>3)</sup>	≥ 1,2	≥ 5/4	Exterior web thickness ≥ 38 mm.	H	<b>0,75</b>
			≥ 7,5/6			<b>1,10</b>
			≥ 10/8			<b>1,50</b>
			≥ 12,5/10			<b>1,50</b>
Lightweight aggregate concrete, LAC, as per EN 1520:2011 EN 771-3:2011+A1:2015	D	≥ 0,9	≥ 5/4	-	H	<b>0,95</b>
			≥ 7,5/6			<b>1,50</b>
Autoclaved aerated concrete blocks, AAC, as per EN 771-4:2011+A1:2015 $h_{nom} = 32,5$ mm	E	≥ 0,50	≥ 5/4	-	R	<b>0,65</b>
Autoclaved aerated concrete blocks, AAC, as per EN 771-4:2011+A1:2015 $h_{nom} = 52,5$ mm <sup>4)</sup>	E					<b>1,10</b>

<sup>1)</sup>The compressive strength of the single brick must not be less than 80% of the mean compressive strength.

<sup>2)</sup> H = Hammer drilling, R = Rotary drilling.

<sup>3)</sup> Vertically perforation > 15 % and ≤ 50 %, cross section reduced by perforation vertically to the resting area.

<sup>4)</sup> Not possible for TermoZ CS II 8/95 and TermoZ CS II 8/115 and TermoZ CS II 8/115 DT 110 V.

<b>fischer TermoZ CS II 8 and fischer TermoZ CS II 8 DT 110 V</b>	<b>Annex C2</b>
<b>Performances</b> Characteristic resistance to tension loads	

**Table C3.1: Plate stiffness according to EOTA Technical Report TR 026:2016-05**

Anchor type	Max. size of the anchor plate $d_p$ [mm]	Load resistance of the anchor plate [kN]	Plate stiffness $c$ [kN/mm]
TermoZ CS II 8	60	2,61	1,29
TermoZ CS II 8 DT 110 V	110	2,61	1,29

**Table C3.2: Point thermal transmittance according to EOTA Technical Report TR 025:2016-05**

TermoZ CS II 8 and TermoZ CS II 8 DT 110 V	$h_{nom}$ [mm]	Thickness of insulation material $h_D$ [mm]	Point thermal transmittance $\chi$ [W/K]					
			Base material groups					
			A	B	C	D	E	
Mounting on the surface	32,5	60	0,002	0,001		0,000		
		80	0,002		0,001			
		100 - 120	0,001					
		140 - 200	0,002		0,001			
		220 - 260	0,002			0,001		
		280 - 300	0,001			0,000		
		320 - 340	0,001					
		360 - 400	0,000					
	52,5	420	0,001	0,000				
		100 - 120	-			0,001		
		140 - 240	-			0,001		
		320	-			0,001		
	Countersunk mounting	32,5	80 - 200	0,001				
			220	0,002			0,001	
			240	0,002	0,001			
			260	0,002		0,001		
280			0,001	0,000				
300			0,001		0,000			
320 - 340			0,001			0,000		
360 - 420			0,000					
52,5		100 - 120	-			0,000		
		140 - 240	-			0,001		
		320	-			0,000		
		400	-			0,000		

**fischer TermoZ CS II 8 and fischer TermoZ CS II 8 DT 110 V**

**Performances**  
Plate stiffness and point thermal transmittance

**Annex C3**

**Table C4.1: Displacements of the TermoZ CS II 8 and TermoZ CS II 8 DT 110 V for façade use**

Base material		Mean compressive strength / minimum compressive strength single brick according to EN 771 <sup>1)</sup> [N/mm <sup>2</sup> ]	Tension load  N <sub>Rd</sub> [kN]	Displacements  Δ(δ <sub>N</sub> ) [mm]
Concrete ≥ C12/15 ≤ C50/60, as per EN 206:2013+A1:2016		-	0,50	< 0,30
Weather resistant concrete shell ≥ C20/25; as per EN 206:2011+A1:2016		-	0,50	< 0,30
Clay brick, Mz, as per EN 771-1:2011+A1:2015		≥ 25/20	0,50	< 0,50
Calcium silicate solid brick, KS, as per EN 771-2:2011+A1:2015		≥ 15/12	0,50	< 0,30
		≥ 25/20	0,50	
Solid lightweight concrete block, Vbl, as per EN 771-3:2011+A1:2015		≥ 10/8	0,43	< 0,40
Solid concrete block, Vbn, as per EN 771-3:2011+A1:2015		≥ 15/12	0,50	< 0,30
		≥ 25/20	0,50	
Vertically perforated clay brick, Hlz, as per EN 771-1:2011+A1:2015	rotary drilling	≥ 15/12	0,33	< 0,50
	hammer drilling		0,22	< 0,30
	rotary drilling	≥ 60/48	0,50	< 0,40
	hammer drilling		0,50	
Hollow calcium silicate brick, KSL, as per EN 771-2:2011+A1:2015		≥ 15/12	0,50	< 0,40
Hollow brick lightweight concrete, Hbl, as per EN 771-3:2011+A1:2015		≥ 5/4	0,17	< 0,20
Hollow brick concrete, Hbn, as per EN 771-3:2011+A1:2015		≥ 5/4	0,25	< 0,20
		≥ 7,5/6	0,37	< 0,30
		≥ 10/8	0,50	< 0,40
		≥ 12,5/10	0,50	< 0,40
Lightweight Aggregate Concrete, ≥ LAC as per EN 1520:2011 / EN 771-3:2011+A1:2015		≥ 5/4	0,32	< 0,50
		≥ 7,5/6	0,50	< 0,50
Autoclaved aerated concrete blocks, AAC, as per EN 771-4:2011+A1:2015	h <sub>nom</sub> = 32,5 mm	≥ 5/4	0,22	< 0,20
	h <sub>nom</sub> = 52,5 mm <sup>2)</sup>		0,37	

<sup>1)</sup>The compressive strength of the single brick must not be less than 80% of the mean compressive strength.

<sup>2)</sup> Not possible for TermoZ CS II 8/95 and TermoZ CS II 8/115 and TermoZ CS II 8/115 DT 110 V.

<b>fischer TermoZ CS II 8 and fischer TermoZ CS II 8 DT 110 V</b>	<b>Annex C4</b>
<b>Performances</b> Displacements	

**Table C5.1: Characteristic load bearing capacity of anchors per m<sup>2</sup> panel under short-term tension load  $N_{Rk,panel,sh}$  [kN/m<sup>2</sup>] and long-term tension load  $N_{Rk,panel,lg}$  [kN/m<sup>2</sup>] on bottom side of ceilings of the TermoZ CS II 8 and TermoZ CS II 8 DT 110 V**

Base material	Amount of anchors per m <sup>2</sup> $n_{panel}$ [-]	Short-term characteristic resistance for single anchor under tension load $N_{Rk,sh}$ [kN]	Characteristic resistance under short-term tension load $N_{Rk,panel,sh}$ [kN/m <sup>2</sup> ]	Long-term characteristic resistance for single anchor under tension load $N_{Rk,lg}$ [kN]	Characteristic resistance under long-term tension load $N_{Rk,panel,lg}$ [kN/m <sup>2</sup> ]
Concrete <sup>1)</sup> ≥ C12/15 ≤ C50/60, as per EN 206:2013+A1:2016, Hammer drilling	$n_{panel}$	<b>0,65</b>	<b>0,65 x <math>n_{panel}</math><sup>2)</sup></b>	<b>0,90</b>	<b>0,90 x <math>n_{panel}</math><sup>2)</sup></b>
	<b>4</b>	<b>0,65</b>	<b>2,60</b>	<b>0,90</b>	<b>3,60</b>
	<b>16</b>	<b>0,65</b>	<b>10,40</b>	<b>0,90</b>	<b>14,40</b>

<sup>1)</sup> Partial factor for concrete  $\gamma_M = 1,80$ .

<sup>2)</sup> In case of different number of anchors per m<sup>2</sup>.

**Table C5.2: Displacement based on characteristic load bearing capacity per m<sup>2</sup> panel of the TermoZ CS II 8 and TermoZ CS II 8 DT 110 V for use on bottom side of ceilings**

Base material	Tension load $N$ [kN]	Short-term $\delta_{sh}$ [mm]	Long-term $\delta_{lg}$ [mm]
Concrete ≥ C12/15 ≤ C50/60, as per EN 206:2013+A1:2016	0,27	0,06	1,10
	0,95	0,06	1,10

**fischer TermoZ CS II 8 and fischer TermoZ CS II 8 DT 110 V**

**Performances**

Characteristic load bearing capacity of anchors per panel  
Displacement based on characteristic load bearing capacity per panel

**Annex C5**