



YDEEVNEDEKLARATION

DoP 0267

til fischer loftanker FDN II (Metalanker til brug i beton)

DA

1. Varetypens unikke identifikationskode: DoP 0267
2. Anvendelsesformål: Eftermonteret fastgørelse til anvendelse i beton til redundante, ikke-strukturelle systemer, se appendiks, specifikt Bilage B1 - B2.
3. Fabrikant: fischerwerke GmbH & Co. KG, Klaus-Fischer-Str. 1, 72178 Waldachtal, Tyskland
4. Bemyndiget repræsentant: -
5. System(er) til vurdering og kontrol af konstanten af ydeevnen: 2+
6. Europæisk vurderingsdokument: ETAG 001, Part 6, April 2013, anvendt som EAD
Europæisk Teknisk Vurdering: ETA-17/0736; 2018-01-30
Teknisk vurderingsorgan: DIBt- Deutsches Institut für Bautechnik
Notificeret organ(er): 2873 TU Darmstadt
7. Deklareret ydeevne(r):
Sikkerhed under anvendelse (BWR 4)
Karakteristisk modstand for træklast (statisk og quasi-statisk belastning):
Modstand overfor stålsvig: NP
Modstand overfor svigt ved udtrækning: NP
Modstand overfor svigt af beton-kegle: NP
Robusthed: Bilag C1
Min. kant og indbyrdes afstand: Bilag B2, C1
Kantafstand til forhindring af flækning under belastning: NP
- Karakteristisk modstand for tværlast (statisk og quasi-statisk belastning):**
Modstand overfor stålsvig (tværlast): Bilag C1 $V_{Rk,s}=NP$; $k_7=NP$
Modstand overfor svigt ved udtrækning: NP
Modstand overfor svigt af betonkant: NP
- Karakteristisk modstand for alle belastningsrestninger og fejltilstande til forenklet design:**
Karakteristisk modstand: Bilag C1
- Holdbarhed:**
Holdbarhed: Bilag B1
- Brandbeskyttelse (BWR 2)**
Brandegenskaber: Klasse (A1)
- Brandbeskyttelse:**
Brandbeskyttelse overfor stålsvig (spændingslast): NP
Brandbeskyttelse overfor svigt ved udtrækning (spændingslast): NP
Brandbeskyttelse overfor stålsvig (tværlast): NP
Brandmodstand for alle belastningsretninger og fejltilstande: Bilag C1
8. Relevant teknisk dokumentation og/eller specifik teknisk dokumentation: -

Ydeevnen for den vare, der er anført ovenfor, er i overensstemmelse med den deklarerede ydeevne. Denne ydeevnedeklaration er udarbejdet i overensstemmelse med forordning (EU) nr. 305/2011 på eneansvar af den fabrikant, der er anført ovenfor.

Underskrevet for fabrikanten og på dennes vegne af:

Dr.-Ing. Oliver Geibig, Administrerende direktør Forretningsenheder og ingeniørarbejde
Tumlingen, 2021-01-11

Jürgen Grün, Administrerende direktør Kemi & Kvalitet

Denne DoP er tilgængelig i forskellige sprogversioner. I tilfælde af fortolkningsmæssig uoverensstemmelse, henvises der til den engelske version, som altid er gældende.

Appendikset indeholder frivillige og udvidede informationer på engelsk. Disse overgår de lokale (sprogneutrale) retslige krav.

Specific Part

1 Technical description of the product

The Fischer Ceiling Anchor FDN II is an anchor made of galvanized steel which is placed into a drilled hole and anchored by deformation-controlled expansion.

The product description is given in Annex A.

2 Specification of the intended use in accordance with the applicable European Assessment Document

The performances given in Section 3 are only valid if the anchor is used in compliance with the specifications and conditions given in Annex B.

The verifications and assessment methods on which this European Technical Assessment is based lead to the assumption of a working life of the anchor of at least 50 years. The indications given on the working life cannot be interpreted as a guarantee given by the producer, but are to be regarded only as a means for choosing the right products in relation to the expected economically reasonable working life of the works.

3 Performance of the product and references to the methods used for its assessment

3.1 Mechanical resistance and stability (BWR 1)

The essential characteristics regarding mechanical resistance and stability are included under the Basic Works Requirement Safety in use.

3.2 Safety in case of fire (BWR 2)

Essential characteristic	Performance
Reaction to fire	Anchorage satisfies requirements for Class A1
Resistance to fire	See Annex C 1

3.3 Safety in use (BWR 4)

Essential characteristic	Performance
Characteristic resistance in concrete	See Annex C 1

4 Assessment and verification of constancy of performance (AVCP) system applied, with reference to its legal base

In accordance with guideline for European technical approval ETAG 001, April 2013 used as European Assessment Document (EAD) according to Article 66 Paragraph 3 of Regulation (EU) No 305/2011 the applicable European legal act is: [97/161/EC].

The system to be applied is: 2+

Product installation conditions, product marking and product dimensions

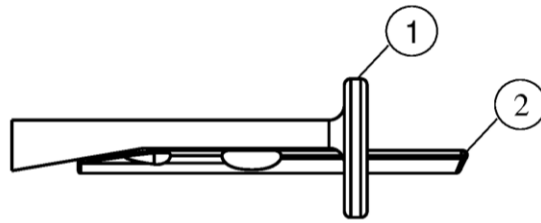

- ① Shaft
- ② Pin

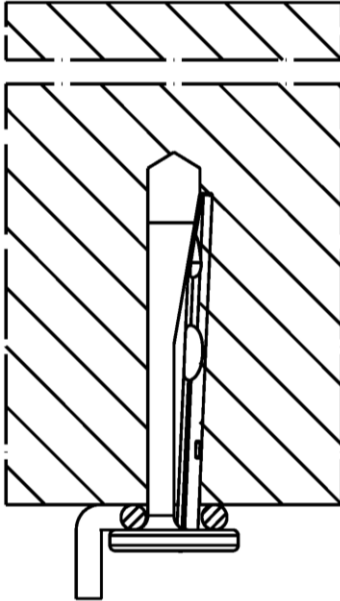

Type of fastener

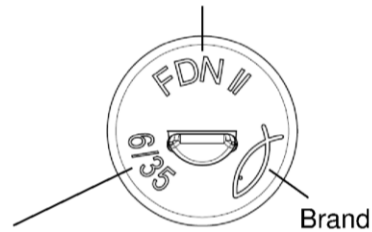

Brand

Nominal diameter / max. thickness of the fixture;
Additional marking "K" for $h_{ef} = 25$ mm

Table A1.1: Dimensions

Size	FDN II			
	6/5 K	6/5	6/35 K	6/35
Length of the $\frac{\text{pin}}{\text{shaft}}$ L_1	36	43	66	73
L_2 [mm]	30,5	37,5	60,5	67,5
Diameter of the head $D \geq$	13			

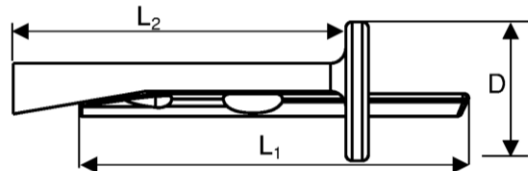

(Fig. not to scale)

fischer Ceiling Anchor FDN II

Product description

Product installation conditions, product marking and product dimensions

Annex A 1

Appendix 2 / 5

Specifications of intended use

Anchorage subject to:

Size	FDN II 6
Static and quasi-static loads	
Use for multiple fixture of non-structural applications according to ETAG 001, Part 6	✓
Fire exposure	

Base materials:

- Reinforced and unreinforced normal weight concrete according to EN 206-1:2000
- Strength classes C12/15 to C50/60 according to EN 206-1:2000
- Cracked and non-cracked concrete

Use conditions (Environmental conditions):

- Anchorage subject to dry internal conditions

Design:

- Anchorages are designed under the responsibility of an engineer experienced in anchorages and concrete work
- Verifiable calculation notes and drawings have to be prepared taking account of the loads to be anchored. The position of the anchor is indicated on the design drawings (e.g. position of the anchor relative to reinforcement or to supports, etc.).
- Anchorages under static or quasi-static actions have to be designed for Design Method C in accordance with:
 - ETAG 001, Annex C, Design Method C, Edition August 2010
 - CEN/TS 1992-4:2009
- Anchorages under fire exposure have to be designed in accordance with
 - EOTA Technical Report TR 020, Edition May 2004
 - CEN/TS 1992-4:2009, Annex D (it must be ensured that local spalling of the concrete cover does not occur)

fischer Ceiling Anchor FDN II

Intended use
Specifications

Annex B 1

Appendix 3 / 5

Table B2.1: Installation parameters

Size		FDN II			
		6/5 K	6/5	6/35 K	6/35
Thickness of the fixture	$t_{fix} \leq$	5		35	
Nominal drill hole diameter	d_0	6			
Diameter of clearance hole in the fixture	$d_f \leq$	7			
Maximum bit diameter	$d_{cut,max}$	6,40			
Effective embedment depth	h_{ef}	25	32	25	32
Depth of drill hole to deepest point	with hole cleaning	30	37	30	37
	without hole cleaning	35	42	35	42
Minimum thickness of concrete member	h_{min}	80			

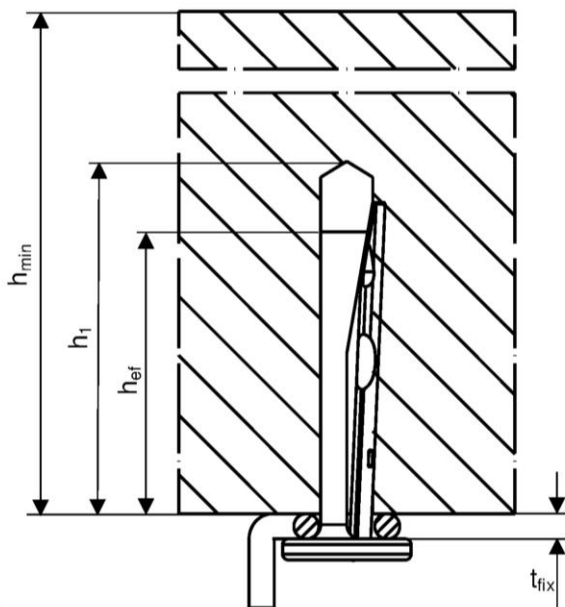

Installation instructions

- Hammer or hollow drilling only
- Anchor installation carried out by appropriately qualified personnel and under the supervision of the person responsible for technical matters of the site
- Positioning of the drill holes without damaging the reinforcement
- In case of aborted hole: New drilling at a minimum distance twice the depth of aborted hole away of or smaller distance if the aborted hole is filled with high strength mortar and if under shear or oblique tension load it is not in the direction of the load application

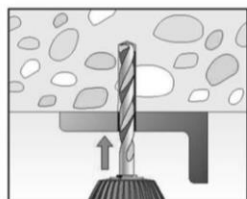

1: Drill the hole

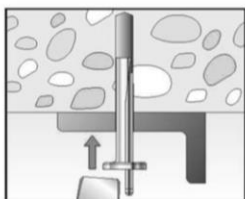

2: Set the fastener

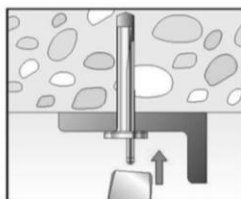

3: Set the pin, until flush to the surface

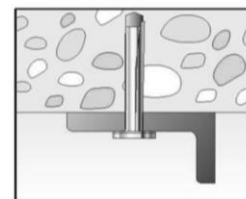

4: Installed fastener

(Fig. not to scale)

fischer Ceiling Anchor FDN II

Intended use

Installation parameters and installation instructions

Annex B 2

Appendix 4 / 5

Table C1.1: Characteristic resistance

Size	FDN II 6	
For all load directions and for all failures modes		
Effective embedment depth	h_{ef} [mm]	25 32
Characteristic resistance in cracked and non-cracked concrete	C12/15	2,0 2,5
	C20/25 to C50/60	2,5 3,5
Characteristic edge distance	$c_{cr,N} = c_{min}$ [mm]	70 60
	spacing	$s_{cr,N} = s_{min}$ [mm]
Partial safety factor	$\gamma_M^{2)}$ [-]	1,5
Shear load with lever arm		
Characteristic bending resistance	$M_{Rk,s}^0$ [Nm]	4,4
Partial safety factor for steel failure	$\gamma_{Ms}^{1)}$ [-]	1,25

¹⁾ In absence of other national regulations

²⁾ The installation safety factor $\gamma_2 = \gamma_{inst} = 1,0$ is included

Table C1.2: Characteristic resistance under fire exposure for all effective embedment depths

Size	FDN II 6	
Steel failure for tension and shear load		
R30	$F_{Rk,s,fi30}$	1,00
R60	$F_{Rk,s,fi60}$	0,50
R90	Characteristic resistance $F_{Rk,s,fi90}$ [kN]	0,34
R120	$F_{Rk,s,fi120}$	0,26
R180	$F_{Rk,s,fi180}$	0,17
Spacing and edge distance		
R30 – R120	$s_{cr,fi}$ [mm]	200
	$c_{cr,fi}$	150

For fire exposure from more than one side $c_{min} \geq 300$ mm