

PROHLÁŠENÍ O VLASTNOSTECH

DoP 0321

pro fischer Strong Undercut Anchor FSU (mechanický kotevní prvek pro použití v betonu)

CS

1. Jedinečný identifikační kód typu výrobku: **DoP 0321**
2. Zamýšlené/zamýšlená použití: **Dodatečné upevnění v tažené a tlačené zóně betonu, viz. dodatek, obzvláště Přílohy B1 - B5.**
3. Výrobce: **fischerwerke GmbH & Co. KG, Klaus-Fischer-Str. 1, 72178 Waldachtal, Německo**
4. Zplnomocněný zástupce: **-**
5. Systém/systémy POSV: **1**
6. Evropský dokument pro posuzování: **EAD 330232-01-0601-v02, Edition 06/2023**
Evropské technické posouzení: **ETA-22/0674; 2023-07-26**
Subjekt pro technické posuzování: **DIBt- Deutsches Institut für Bautechnik**
Oznámený subjekt/oznámené subjekty: **2873 TU Darmstadt**

7. Deklarovaná vlastnost/Deklarované vlastnosti:

Mechanická odolnost a stabilita (BWR 1)

Charakteristická únosnost v tahu (pro statickou a kvazistatickou akci) Metoda A:

Odolnost proti selhání oceli: viz. dodatek, obzvláště Příloha C1

$E_s = 210\,000\text{ MPa}$

Odolnost proti selhání vytažením: viz. dodatek, obzvláště Příloha C1

Odolnost proti selhání betonu: viz. dodatek, obzvláště Příloha C1

Pevnost: viz. dodatek, obzvláště Příloha C1

Minimální vzdálenost od okraje a rozteč: viz. dodatek, obzvláště Příloha C3

Okrajová vzdálenost bránící rozštěpení při zatížení: viz. dodatek, obzvláště Příloha C1

Charakteristická únosnost ve smyku (pro statickou a kvazistatickou akci), Metoda A:

Odolnost proti selhání oceli (smykové zatížení): viz. dodatek, obzvláště Příloha C2

Odolnost proti selhání rozštěpením: viz. dodatek, obzvláště Příloha C2

Charakteristická odolnost pro zjednodušený design:

Metoda B: NPD

Metoda C: NPD

Posuny:

Posuny při statickém a kvazistatickém zatížení: viz. dodatek, obzvláště Příloha C6

Charakteristická únosnost a posuny pro seismické kategorie C1 a C2:

Odolnost proti tahovému zatížení, posuny, kategorie C1: viz. dodatek, obzvláště Příloha C5

Odolnost proti tahovému zatížení, posuny, kategorie C2: viz. dodatek, obzvláště Přílohy C5, C6

Odolnost proti smykovému zatížení, posuny, kategorie C1: viz. dodatek, obzvláště Příloha C5

Odolnost proti smykovému zatížení, posuny, kategorie C2: viz. dodatek, obzvláště Přílohy C5, C6

Koeficient prstencové mezery: viz. dodatek, obzvláště Příloha C5

Bezpečnost v případě požáru (BWR 2)

Reakce na oheň: Třída (A1)

Odolnost proti požáru:

Požární odolnost proti selhání oceli (tahové zatížení): viz. dodatek, obzvláště Příloha C4

Požární odolnost proti selhání vytažením (tahové zatížení): viz. dodatek, obzvláště Příloha C4

Požární odolnost proti selhání oceli (smykové zatížení): viz. dodatek, obzvláště Příloha C4

Životnost:

Životnost: viz. dodatek, obzvláště Přílohy A2, B1

8. Příslušná technická dokumentace a/nebo specifická technická dokumentace: –

Vlastnosti výše uvedeného výrobku jsou ve shodě se souborem deklarovaných vlastností. Toto prohlášení o vlastnostech se v souladu s nařízením (EU) č. 305/2011 vydává na výhradní odpovědnost výrobce uvedeného výše.

Podepsáno za výrobce a jeho jménem:



Dr.-Ing. Oliver Geibig, Výkonný ředitel pro obchodní jednotky a inženýrství
Tumlingen, 2023-09-01



Jürgen Grün, Výkonný ředitel pro chemii a kvalitu

Toto PoV bylo připraveno v různých jazykových mutacích. V případě rozporu vždy rozhoduje interpretace verze v anglickém jazyce.

Příloha obsahuje nepovinné a doplňkové informace v anglickém jazyce nad rámec zákonných požadavků.

Translation guidance Essential Characteristics and Performance Parameters for Annexes

Pokyny pro překlad Základní charakteristiky a výkonnostní parametry příloh

Mechanical resistance and stability (BWR 1)		
Mechanická odolnost a stabilita (BWR 1)		
Characteristic resistance under static and quasi-static loading, Method A		
Charakteristická únosnost v tahu (pro statickou a kvazistatickou akci) Metoda A:		
1	Resistance to steel failure: Odolnost proti selhání oceli:	$N_{Rk,s}$ [kN], E_s [N/mm ²]
2	Resistance to pull-out failure: Odolnost proti selhání vytažením:	$N_{Rk,p}$ [kN], ψ_c
3	Resistance to concrete cone failure: Odolnost proti selhání betonu:	$k_{cr,N}$, $k_{ucr,N}$ [-], h_{ef} , $c_{cr,N}$ [mm]
4	Robustness: Pevnost:	V_{inst} [-]
5	Minimum edge distance and spacing: Minimální vzdálenost od okraje a rozteč:	c_{min} , s_{min} , h_{min} [mm]
6	Edge distance to prevent splitting under load: Okrajová vzdálenost brání rozštěpení při zatížení:	$N^0_{Rk,sp}$ [kN], $c_{cr,sp}$ [mm]
Characteristic resistance to shear load (static and quasi-static loading), Method A		
Charakteristická únosnost ve smyku (pro statickou a kvazistatickou akci), Metoda A:		
7	Resistance to steel failure under shear load: Odolnost proti selhání oceli (smykové zatížení):	$V^0_{Rk,s}$ [kN], $M^0_{Rk,s}$ [Nm], k_7 [-]
8	Resistance to pry-out failure: Odolnost proti selhání rozštěpením:	k_8 [-]
Characteristic Resistance for simplified design		
Charakteristická odolnost pro zjednodušený design:		
9	Method B: Metoda B:	F^0_{Rk} [kN], c_{cr} , s_{cr} [mm]
10	Method C: Metoda C:	F_{Rk} [kN]
Displacements		
Posuny:		
11	Displacements under static and quasi-static loading: Posuny při statickém a kvazistatickém zatížení:	δ_{N0} , $\delta_{N\infty}$, δ_{V0} , $\delta_{V\infty}$ [mm]
Characteristic resistance and displacements for seismic performance categories C1 and C2		
Charakteristická únosnost a posuny pro seismické kategorie C1 a C2:		
12	Resistance to tension load, displacements, category C1: Odolnost proti tahovému zatížení, posuny, kategorie C1:	$N_{Rk,s,C1}$ [kN], $N_{Rk,p,C1}$ [kN]
	Resistance to tension load, displacements, category C2: Odolnost proti tahovému zatížení, posuny, kategorie C2:	$N_{Rk,s,C2}$ [kN], $N_{Rk,p,C2}$ [kN], $\delta_{N,C2}$ [mm]
13	Resistance to shear load, displacements, category C1: Odolnost proti smykovému zatížení, posuny, kategorie C1:	$V_{Rk,s,C1}$ [kN]
	Resistance to shear load, displacements, category C2: Odolnost proti smykovému zatížení, posuny, kategorie C2:	$V_{Rk,s,C2}$ [kN], $\delta_{V,C2}$ [mm]
14	Factor for annular gap Koeficient prstencové mezery:	α_{gap} [-]
Safety in case of fire (BWR 2)		
Bezpečnost v případě požáru (BWR 2)		
15	Reaction to fire: Reakce na oheň:	Class
Resistance to fire:		
Odolnost proti požáru:		
16	Fire resistance to steel failure (tension load): Požární odolnost proti selhání oceli (tahové zatížení):	$N_{Rk,s,fi}$ [kN]
17	Fire resistance to pull-out failure (tension load): Požární odolnost proti selhání vytažením (tahové zatížení):	$N_{Rk,p,fi}$ [kN]
18	Fire resistance to steel failure (shear load): Požární odolnost proti selhání oceli (smykové zatížení):	$V_{Rk,s,fi}$ [kN], $M^0_{Rk,s,fi}$ [Nm]
Aspects of durability		
Životnost:		
19	Durability: Životnost:	Class

Specific Part

1 Technical description of the product

The fischer Strong Undercut Anchor is an anchor made of galvanized steel which is placed in a cylindrical hole and anchored by displacement-controlled, self-undercutted mechanical interlock. The product description is given in Annex A.

2 Specification of the intended use in accordance with the applicable European Assessment Document

The performances given in Section 3 are only valid if the anchor is used in compliance with the specifications and conditions given in Annex B.

The verifications and assessment methods on which this European Technical Assessment is based lead to the assumption of a working life of the anchor of at least 50 years. The indications given on the working life cannot be interpreted as a guarantee given by the producer, but are to be regarded only as a means for choosing the right products in relation to the expected economically reasonable working life of the works.

3 Performance of the product and references to the methods used for its assessment

3.1 Mechanical resistance and stability (BWR 1)

Essential characteristic	Performance
Characteristic resistance to tension load (static and quasi-static loading), Method A	See Annex C 1 and C 3
Characteristic resistance to shear load (static and quasi-static loading)	See Annex C 2
Displacements	See Annex C 6
Characteristic resistance and displacements for seismic performance categories C1 and C2	See Annex C 5 and C 6

3.2 Safety in case of fire (BWR 2)

Essential characteristic	Performance
Reaction to fire	Class A1
Resistance to fire	See Annex C 4

3.3 Aspects of Durability

Essential characteristic	Performance
Durability	See Annex B 1

4 Assessment and verification of constancy of performance (AVCP) system applied, with reference to its legal base

In accordance with the European Assessment Document EAD 330232-01-0601-v02 the applicable European legal act is: [96/582/EC].

The system to be applied is: 1

Pre-setting anchor FSU

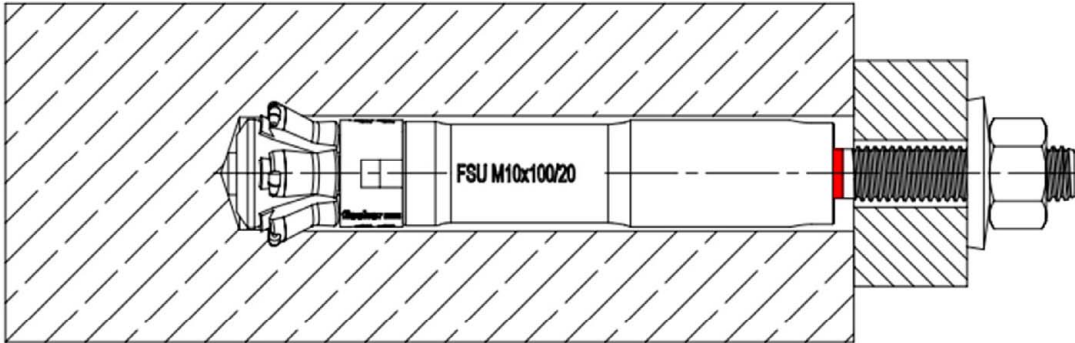

Push-through anchor FSU-P

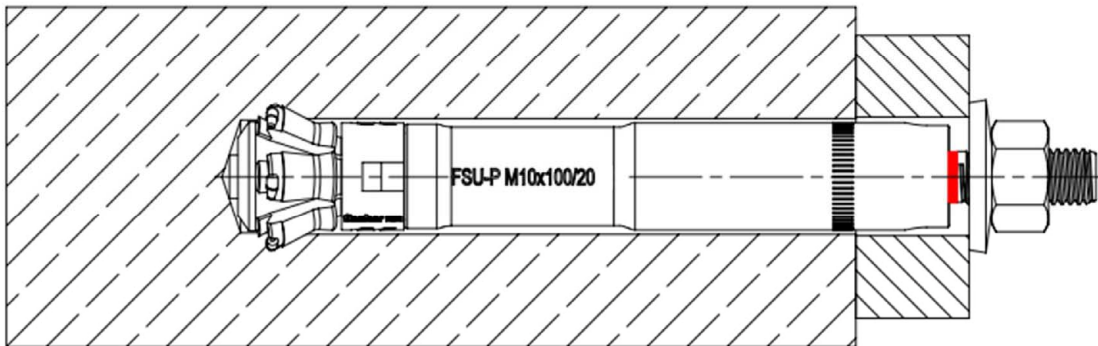

(Fig. not to scale)

fischer Strong Undercut Anchor FSU

Product description
Installed condition

Annex A 1

Appendix 3 / 16

Pre-setting anchor FSU

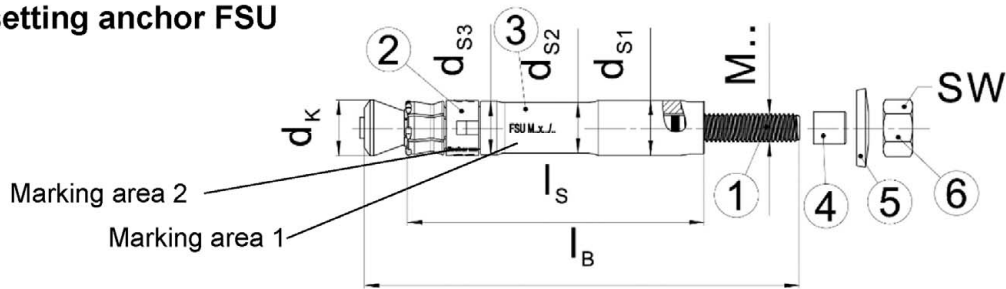

Push-through anchor FSU-P

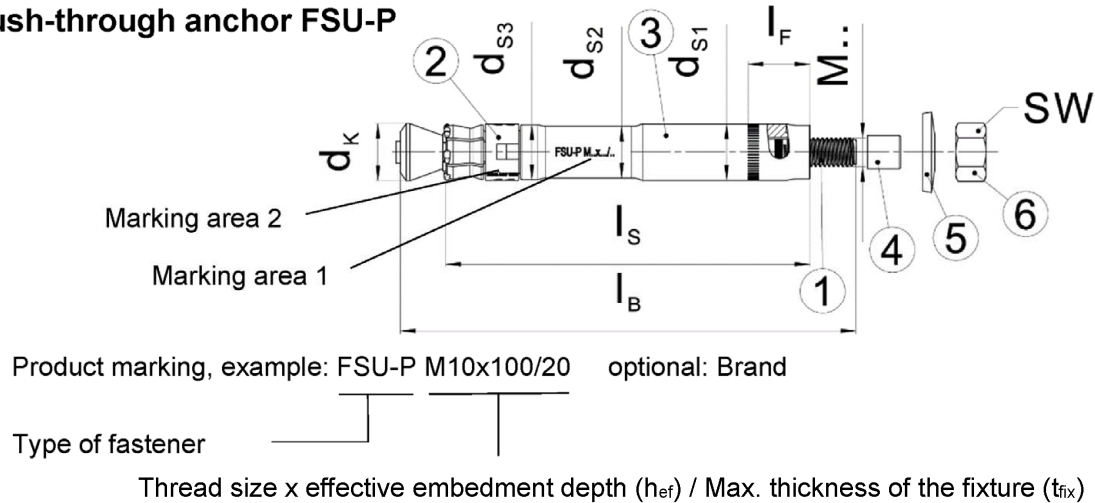

Table A2.1: Dimensions [mm]

Type of anchor	t_{fix}	d_k	d_{s1}	d_{s2}	d_{s3}	M	l_s	l_B	l_F	SW
FSU M10x100/20	≤ 20	19,3	19	17,5	18,5	10	100	148	-	17
FSU M12x125/30	≤ 30	21,5	21	19,3	20,5	12	125	188	-	19
FSU M12x125/50	≤ 50	21,5	21	19,3	20,5	12	125	208	-	19
FSU-P M10x100/20	$\geq 10 \leq 20$	19,3	19	17,5	18,5	10	120	148	20	17
FSU-P M12x125/30	$\geq 12 \leq 30$	21,5	21	19,3	20,5	12	155	188	30	19
FSU-P M12x125/50	$\geq 12 \leq 50$	21,5	21	19,3	20,5	12	175	208	50	19

Table A2.2: Materials FSU

Part	Designation	Material
		FSU, FSU-P
1	Cone bolt	Steel, zinc plated $\geq 5 \mu\text{m}$ according to EN ISO 4042:2018
2	Plastic sleeve	Plastic
3	Sleeve	Steel, zinc plated $\geq 5 \mu\text{m}$ according to EN ISO 4042:2018
4	Protective cap	Plastic
5	Washer	Steel, zinc plated $\geq 5 \mu\text{m}$ according to EN ISO 4042:2018
6	Hexagon nut	Steel, zinc plated $\geq 5 \mu\text{m}$ according to EN ISO 4042:2018

(Fig. not to scale)

fischer Strong Undercut Anchor FSU

Product description
Product marking, dimensions and materials

Annex A 2

Appendix 4 / 16

Stop drill bit FSU-SD

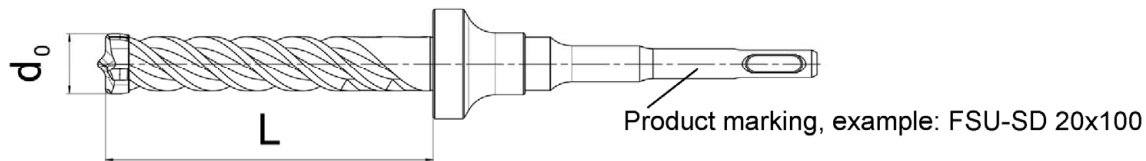

Table A3.1: Required stop drill bits for FSU

Type of anchor	Type of stop drill bit	d ₀ [mm]	L [mm]
FSU M10x100/20	FSU-SD 20x100	20	107
FSU M12x125/30	FSU-SD 22x125	22	132
FSU M12x125/50			
FSU-P M10x100/20	FSU-SD 20x120	20	127
FSU-P M12x125/30	FSU-SD 22x155	22	162
FSU-P M12x125/50	FSU-SD 22x175	22	182

Machine setting tool FSU-ST

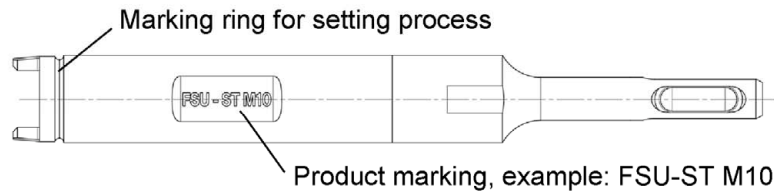

Table A3.2: Required setting tools for FSU

Type of anchor	Type of setting tool
FSU M10x100/20	FSU-ST M10
FSU M12x125/30	FSU-ST M12
FSU M12x125/50	
FSU-P M10x100/20	FSU-ST M10
FSU-P M12x125/30	FSU-ST M12
FSU-P M12x125/50	

Table A3.3: Recommendations for hammer drills used with FSU-ST

Technical feature	Recommendation
Drill chuck [-]	SDS plus
Hammer drilling RPM [rpm]	600 - 1800
Hammer impact energy [J]	2 - 5

(Fig. not to scale)

fischer Strong Undercut Anchor FSU

Product description
Setting tools

Annex A 3

Appendix 5 / 16

Specifications of intended use

Fastenings subject to:

Size	FSU			FSU-P			
	M10x100 /20	M12x125 /30	M12x125 /50	M10x100 /20	M12x125 /30	M12x125 /50	
Static and quasi-static loads	✓						
Cracked and uncracked concrete							
Seismic performance category							C1
							C2
Fire exposure							

Base materials:

- Compacted reinforced and unreinforced normal weight concrete without fibres (cracked and uncracked) according to EN 206:2013+A2:2021
- Strength classes C20/25 to C50/60 according to EN 206:2013+A2:2021

Use conditions (Environmental conditions):

- Structures subject to dry internal conditions

Design:

- Anchorages are designed under the responsibility of an engineer experienced in anchorages and concrete work.
- Verifiable calculation notes and drawings are prepared taking account of the loads to be anchored. The position of the anchor is indicated on the design drawings (e.g. position of the anchor relative to reinforcement or to supports, etc.).
- Anchorages are designed in accordance with EN 1992-4:2018 and EOTA Technical Report TR 055:2018.
- For requirements to resistance to fire local spalling of the concrete cover must be avoided

fischer Strong Undercut Anchor FSU

Intended Use
Specifications

Annex B 1

Appendix 6 / 16

Installation parameters

Table B2.1: Installation parameters

Size	FSU			FSU-P		
	M10x100 /20	M12x125 /30	M12x125 /50	M10x100 /20	M12x125 /30	M12x125 /50
Nominal drill hole diameter	d_0	20	22	22	20	22
Cutting diameter of drill bits	$d_{cut} \leq$	20,5	22,5	22,5	20,5	22,5
Depth of drill hole to deepest point	$h_1 \geq$	107	132	132	$127-t_{fix}$	$182-t_{fix}$
Effective embedment depth	$h_{ef} \geq$	100	125	125	100	125
Diameter of clearance hole in the fixture	$d_f \leq$	12	14	14	21	23
Thickness of the fixture	t_{fix}	≤ 20	≤ 30	≤ 50	$\geq 10 \leq 20$	$\geq 12 \leq 30$
Gap after setting	U	2 - 5	3 - 6	3 - 6	2 - 5	3 - 6
Required setting torque	T_{inst} [Nm]	40	80	80	40	80

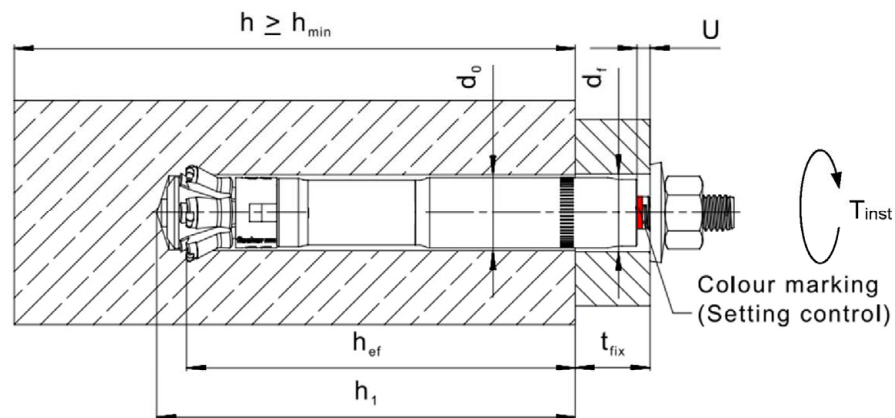
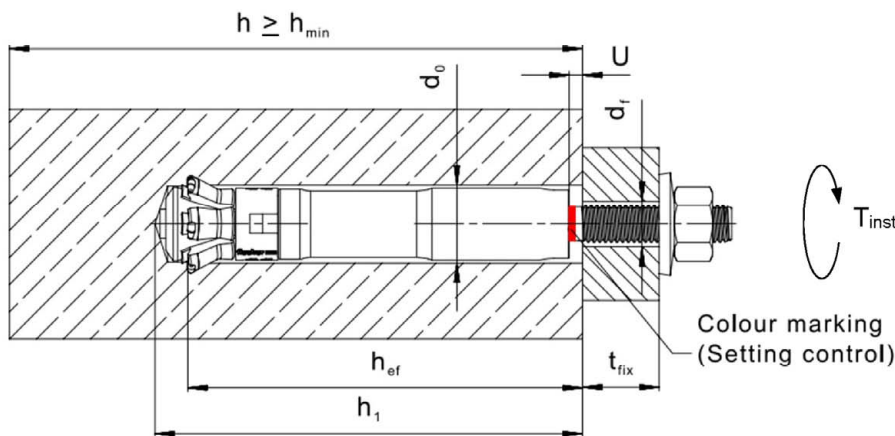

(Fig. not to scale)

fischer Strong Undercut Anchor FSU

Intended Use
Installation parameters

Annex B 2

Appendix 7 / 16

Installation instructions

- Fastener installation carried out by appropriately qualified personnel according to the design drawings and under the supervision of the person responsible for technical matters on the site.
- Use of the fastener only as supplied by the manufacturer without exchanging the components of the fastener.
- Fastener installation in accordance with the manufacturer's specifications and drawings and using the appropriate tools (machine setting tool FSU-ST, stop drill bit FSU-SD).
- Drill hole created perpendicular (tolerance +/- 5°) to concrete surface.
- Cleaning the hole of drilling dust.
- Fastener installation ensuring complete expansion of the sleeve with checking that the coloured ring marking on the bolt is visible above the top edge of the anchor sleeve, therefore it is required using the setting tool FSU-ST, that is the appropriate depth ring marking of the setting tool at least flush with the concrete surface (pre-setting) respecting with the fixture surface (Push-through-setting).
- Fastener installation ensuring complete shear load capacity, after setting the gap between the top edge of the sleeve and the concrete surface (pre-setting) or with surface of the fixture (Push-through-setting) has to be in the specified range according to Annex B 2, Table B2.1.
- Positioning of the drill holes and the undercut without damaging the reinforcement.
- In case of aborted hole: new drilling at a minimum distance twice the depth of the aborted drill hole or smaller distance, if the aborted drill hole is filled with high strength mortar and, if under shear or oblique tension load, it is not in the direction of load application.
- Application of the torque moment given in Annex B 2, Table B2.1 using a calibrated torque wrench.

fischer Strong Undercut Anchor FSU

Intended Use
Installation instructions

Annex B 3

Appendix 8 / 16

Installation instructions for pre-setting anchor FSU

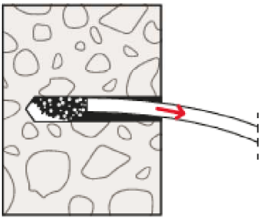
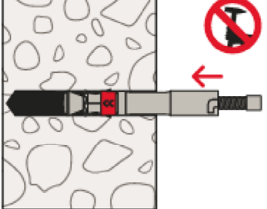
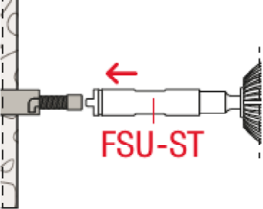
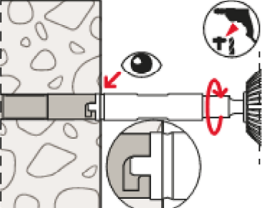
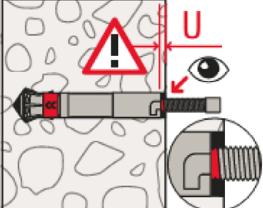
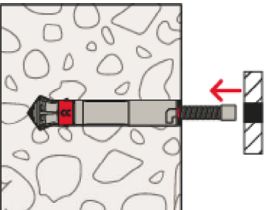
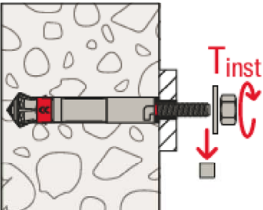
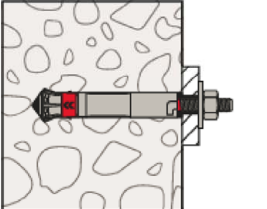
<p>1)</p> 	<p>2)</p> 	<ol style="list-style-type: none"> 1) Drill the hole with the designated stop drill bit FSU-SD (see Table A3.1). 2) Clean the hole.
<p>3)</p> 	<p>4)</p> 	<ol style="list-style-type: none"> 3) Place the anchor in the hole by hand. Do not use any hammering tools. 4) Use the designated setting tool FSU-ST (see Table A3.2) and follow the recommendations for the hammer drill (see Table A3.3).
<p>5)</p> 	<p>6)</p> 	<ol style="list-style-type: none"> 5) Place the setting tool in the grooves provided on the anchor. Carry out the setting process with the rotary-impact mode of the hammer drill. The setting process is completed when the marking ring of the setting tool is flush with the concrete surface. 6) After removing the setting tool, the red coloured ring marking on the bolt must be visible above the top edge of the anchor sleeve. The gap U between the top edge of the sleeve and the concrete surface must be in the specified range according to Table B2.1.
<p>7)</p> 	<p>8)</p> 	<ol style="list-style-type: none"> 7) Place the fixture. 8) Remove the protective cap. Place the spring washer and the hexagon nut on the bolt. Take care of the right orientation of the spring washer, in the way, that the outer diameter of the washer in uncompressed condition is in touch with the fixture, only. Apply the installation torque.
<p>9)</p> 		<ol style="list-style-type: none"> 9) Correctly installed fastener.

fischer Strong Undercut Anchor FSU

Intended Use
Installation instructions

Annex B 4

Appendix 9 / 16

Installation instructions for push-through anchor FSU-P

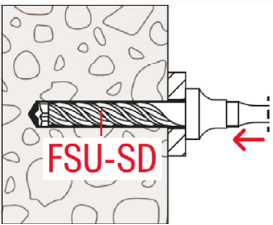
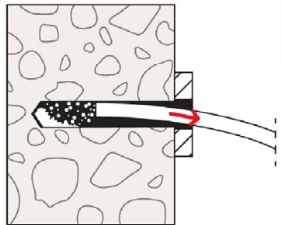
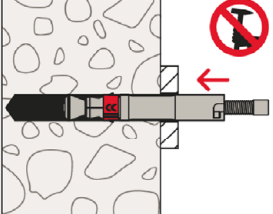
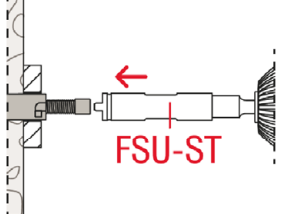
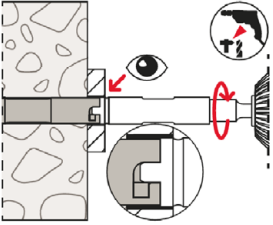
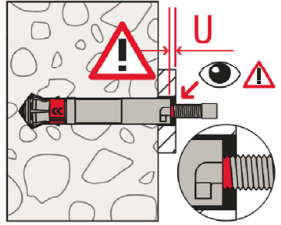
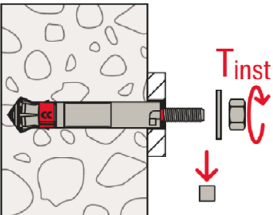
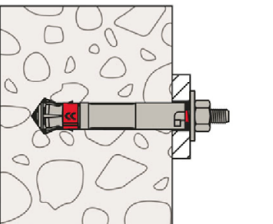
<p>1) </p>	<p>2) </p>	<ol style="list-style-type: none"> 1) Drill the hole with the designated stop drill bit FSU-SD (see table A3.1) in compliance with the specified range of fixture thicknesses (see Table B2.1). 2) Clean the hole.
<p>3) </p>	<p>4) </p>	<ol style="list-style-type: none"> 3) Place the anchor in the hole by hand. Do not use any hammering tools. 4) Use the designated setting tool FSU-ST (see Table A3.2) and follow the recommendations for the hammer drill (see Table A3.3).
<p>5) </p> <p>6) </p>		<ol style="list-style-type: none"> 5) Place the setting tool in the grooves provided on the anchor. Carry out the setting process with the rotary-impact mode of the hammer drill. The setting process is completed when the marking ring of the setting tool is flush with the fixture surface. 6) After removing the setting tool, the red coloured ring marking on the bolt must be visible above the top edge of the anchor sleeve. The gap U between the top edge of the sleeve and the fixture surface must be in the specified range according to Table B2.1.
<p>7) </p>		<ol style="list-style-type: none"> 7) Remove the protective cap. Place the spring washer and the hexagon nut on the bolt. Take care of the right orientation of the spring washer, in the way, that the outer diameter of the washer in uncompressed condition is in touch with the fixture, only. Apply the installation torque.
<p>8) </p>		<ol style="list-style-type: none"> 8) Correctly installed fastener.

fischer Strong Undercut Anchor FSU

Intended Use
Installation instructions

Annex B 5

Appendix 10 / 16

Table C1.1: Characteristic tension resistance under static and quasi-static action

Size				FSU, FSU-P	
				M10x100	M12x125
Steel failure					
Characteristic resistance	$N_{Rk,s}$	[kN]	44,2	65,9	
Partial factor for steel failure	γ_{Ms}	[-]	1,5		
Pullout failure					
Characteristic resistance in C20/25	cracked concrete	$N_{Rk,p}$	[kN]	30,0	40,0
	uncracked concrete			44,2	65,9
Increasing factor for $N_{Rk,p}$ $N_{Rk,p} = \psi_c * N_{Rk,p} (C20/25)$	ψ_c [-]	C25/30	1,12		
		C30/37	1,22		
		C35/45	1,32		
		C40/50	1,41		
		C45/55	1,50		
		C50/60	1,58		
Installation sensitivity factor	γ_{inst}	[-]	1,0		
Concrete cone and splitting failure					
Effective embedment depth	h_{ef}	[mm]	100	125	
Factor for cracked concrete	$k_{cr,N}$	[-]	8,9		
Factor for uncracked concrete	$k_{ucr,N}$		12,7		
Characteristic spacing	$s_{cr,N}$	[mm]	3 x h_{ef}		
Characteristic edge distance	$c_{cr,N}$		1,5 x h_{ef}		
Characteristic spacing	$s_{cr,sp}$		3 x h_{ef}		
Characteristic edge distance	$c_{cr,sp}$		1,5 x h_{ef}		
Characteristic resistance to splitting	$N^0_{Rk,sp}$		[kN]	$\min \{N^0_{Rk,c}; N_{Rk,p}\}^{1)}$	

¹⁾ $N^0_{Rk,c}$ according to EN 1992-4:2018

fischer Strong Undercut Anchor FSU

Performances

Characteristic tension resistance under static and quasi-static action

Annex C 1

Appendix 11 / 16

Table C2.1: Characteristic shear resistance under static and quasi-static action FSU

Size			FSU	
			M10x100	M12x125
Steel failure without lever arm				
Characteristic resistance	$V_{RK,s}^0$	[kN]	26,8	38,2
Partial factor for steel failure	γ_{Ms}	[-]	1,25	
Factor for ductility	k_7		1,0	
Steel failure with lever arm				
Characteristic bending resistance	$M_{RK,s}^0$	[Nm]	59,8	104,8
Partial factor for steel failure	γ_{Ms}	[-]	1,25	
Concrete pryout failure				
Factor for pryout failure	k_8	[-]	2,0	
Concrete edge failure				
Effective length in concrete	l_f	[mm]	100	125
Effective diameter of fastener	d_{nom}		19	21

Table C2.2: Characteristic shear resistance under static and quasi-static action FSU-P

Size			FSU-P			
			M10x100		M12x125	
Steel failure without lever arm						
Characteristic resistance	for t_{fix}	[mm]	$10 \leq t_{fix} < 15$	$15 \leq t_{fix} \leq 20$	$12 \leq t_{fix} < 20$	$20 \leq t_{fix} \leq 50$
	$V_{RK,s}^0$	[kN]	66,1	69,6	86,4	96,7
Partial factor for steel failure	γ_{Ms}	[-]	1,25			
Factor for ductility	k_7		1,0			
Steel failure with lever arm						
Characteristic bending resistance	$M_{RK,s}^0$	[Nm]	59,8		104,8	
Partial factor for steel failure	γ_{Ms}	[-]	1,25			
Concrete pryout failure						
Factor for pryout failure	k_8		2,0			
Concrete edge failure						
Effective length in concrete	l_f	[mm]	100		125	
Effective diameter of fastener	d_{nom}		19		21	

fischer Strong Undercut Anchor FSU

Performances

Characteristic shear resistance under static and quasi-static action

Annex C 2

Appendix 12 / 16

Table C3.1: Minimum thickness of concrete members FSU

Size	FSU		
	M10x100/20	M12x125/30	M12x125/50
Minimum thickness of concrete member h_{min} [mm]	170	215	

Table C3.2: Minimum thickness of concrete members FSU-P

Size	FSU-P		
	M10x100/20	M12x125/30	M12x125/50
Maximum thickness of the fixture $t_{fix,max}$ [mm]	20	30	50
Minimum thickness of concrete member h_{min}	$190-t_{fix}^{1)}$	$245-t_{fix}^{1)}$	$265-t_{fix}^{1)}$

¹⁾ t_{fix} = actual thickness of the fixture

Table C3.3: Minimum spacings and edge distances

Size	FSU, FSU-P		
	M10x100/20	M12x125/30	M12x125/50
Minimum spacing s_{min} [mm]	80	90	
Minimum edge distance c_{min}	80	90	

fischer Strong Undercut Anchor FSU

Performances

Minimum thickness of concrete member, minimum spacings and edge distances

Annex C 3

Appendix 13 / 16

Table C4.1: Characteristic tension resistance under fire exposure

Size	FSU, FSU-P			
		M10x100	M12x125	
Characteristic resistance steel failure	$N_{Rk,s,fi}$	R30	3,7	4,5
		R60	2,2	3,2
		R90	1,7	2,8
		R120	1,5	2,6
Characteristic resistance Concrete cone failure	$N_{Rk,c,fi}$	R30-R90 [kN]	19,9	34,8
		R120	15,9	27,7
Characteristic resistance pullout failure	$N_{Rk,p,fi}$	R30-R90	7,5	10,0
		R120	6,0	8,0

Table C4.2: Characteristic shear resistance under fire exposure

Size	FSU, FSU-P			
		M10x100	M12x125	
Characteristic resistance steel failure without lever arm	$V_{Rk,s,fi}$	R30 [kN]	3,7	4,4
		R60	2,2	3,0
		R90	1,7	2,6
		R120	1,5	2,3
Characteristic bending resistance steel failure with lever arm	$M^0_{Rk,s,fi}$	R30 [Nm]	4,8	6,9
		R60	2,9	5,0
		R90	2,2	4,4
		R120	1,9	4,0

Concrete pryout failure according to EN 1992-4:2018

Table C4.3: Minimum spacings and minimum edge distances under fire exposure for tension and shear load

Size	FSU, FSU-P	
	All sizes	
Spacing	$s_{min,fi}$	$4 \cdot h_{ef}$
Edge distance	$c_{min,fi}$	$c_{min,fi} = 2 \cdot h_{ef}$, for fire exposure from more than one side $c_{min,fi} \geq 300$ mm

fischer Strong Undercut Anchor FSU

Performances
 Characteristic resistance under fire exposure
Annex C 4

Appendix 14 / 16

Table C5.1: Characteristic values of tension and shear resistance under seismic performance category C1

Size	FSU, FSU-P				
	M10x100		M12x125		
Factor for annular gap Without filling of annular gap α_{gap} [-]	0,5				
Steel failure					
Characteristic resistance tension load C1 $N_{RK,s,C1}$ [kN]	44,2		65,9		
Pullout failure					
Characteristic resistance tension load in cracked concrete C1 $N_{RK,p,C1}$ [kN]	30,0		40,0		
Steel failure without lever arm					
Characteristic resistance shear load C1 $V_{RK,s,C1}$ [kN]	for t_{fix} [mm]	$10 \leq t_{fix} < 15$	$15 \leq t_{fix} \leq 20$	$12 \leq t_{fix} < 20$	$20 \leq t_{fix} \leq 50$
	$V_{RK,s,C1}$ FSU	18,8		26,8	
	$V_{RK,s,C1}$ FSU-P	46,3	48,7	60,5	67,7

Table C5.2: Characteristic values of tension and shear resistance under seismic performance category C2

Size	FSU, FSU-P				
	M10x100		M12x125		
Factor for annular gap Without filling of annular gap α_{gap} [-]	0,5				
Steel failure					
Characteristic resistance tension load C2 $N_{RK,s,C2}$ [kN]	44,2		65,9		
Pullout failure					
Characteristic resistance tension load in cracked concrete C2 $N_{RK,p,C2}$ [kN]	30,0		40,0		
Steel failure without lever arm					
Characteristic resistance shear load C2 $V_{RK,s,C2}$ [kN]	for t_{fix} [mm]	$10 \leq t_{fix} < 15$	$15 \leq t_{fix} \leq 20$	$12 \leq t_{fix} < 20$	$20 \leq t_{fix} \leq 50$
	$V_{RK,s,C2}$ FSU	20,1		24,5	
	$V_{RK,s,C2}$ FSU-P	39,6	41,8	51,8	62,9

fischer Strong Undercut Anchor FSU

Performances
Characteristic resistance under seismic performance categories C1 and C2

Annex C 5

Appendix 15 / 16

Table C6.1: Displacements under static and quasi-static tension loads

Size			FSU, FSU-P	
			M10x100	M12x125
Tension load in cracked concrete C20/25	N	[kN]	22,1	32,1
Displacements	$\frac{\delta_{N0}}{\delta_{N\infty}}$	[mm]	1,1	1,3
			2,8	3,0
Tension load in uncracked concrete C20/25	N	[kN]	22,1	32,1
Displacements	$\frac{\delta_{N0}}{\delta_{N\infty}}$	[mm]	1,1	1,3
			2,3	2,3

Table C6.2: Displacements under static and quasi-static shear loads

Size			FSU, FSU-P	
			M10x100	M12x125
Shear load in cracked and uncracked concrete C20/25	V	[kN]	13,8	21,3
Displacements FSU	$\frac{\delta_{V0}}{\delta_{V\infty}}$	[mm]	5,4	6,7
			8,0	10,0
Shear load in cracked and uncracked concrete C20/25	V	[kN]	36,3	52,2
Displacements FSU-P	$\frac{\delta_{V0}}{\delta_{V\infty}}$	[mm]	5,9	7,2
			8,8	10,7

Table C6.3: Displacements under tension loads for seismic performance category C2

Size			FSU, FSU-P	
			M10x100	M12x125
Displacement	DLS	$\delta_{N,C2}$	[mm]	4,6
	ULS			11,4
				10,4

Table C6.4: Displacements under shear loads for seismic performance category C2

Size			FSU, FSU-P	
			M10x100	M12x125
Displacement FSU	DLS	$\delta_{V,C2}$	[mm]	5,2
	ULS			7,3
				6,7
Displacement FSU-P	DLS	$\delta_{V,C2}$	[mm]	4,8
	ULS			10,7
				18,5

fischer Strong Undercut Anchor FSU

Performances

Displacement under tension and shear loads

Annex C 6

Appendix 16 / 16