

PROHLÁŠENÍ O VLASTNOSTECH

DoP 0368

pro injekční systém fischer FIS EM Plus (Malta pro dodatečně instalované spoje)

CS

1. Jedinečný identifikační kód typu výrobku: DoP 0368
2. Zamýšlené/zamýšlená použití: Lepené tyče pro dřevěné spoje, виж Приложението, по-специално Приложения В1-В7.
3. Výrobce: fischerwerke GmbH & Co. KG, Otto-Hahn-Straße 15, 79211 Denzlingen, Německo
4. Zplnomocněný zástupce: -
5. Systém/systémy POSV: 3
6. Evropský dokument pro posuzování: EAD 130006-00-0304
Evropské technické posouzení: ETA-19/0657; 2024-09-13
Subjekt pro technické posuzování: DIBt- Deutsches Institut für Bautechnik
7. Deklarovaná vlastnost/Deklarované vlastnosti:
Mechanická odolnost a stabilita (BWR 1)
 - 1 Pevnost spoje při podélném tahovém smyku: viz. dodatek, obzvláště Příloha C1
 - 2 Odolnost proti delaminaci: viz. dodatek, obzvláště Příloha C1
 - 3 Vliv smršnění dřeva na smykovou pevnost: viz. dodatek, obzvláště Příloha C1
 - 4 Vliv tlakového smyku a klimatických změn: viz. dodatek, obzvláště Příloha C1
 - 5 Smyková pevnost zalepených ocelových tyčí: viz. dodatek, obzvláště Příloha C1
 - 6 Doba zatížení: NPD
 - 7 Krychová zkouška spojení při velmi vysokém a nízkém obsahu vlhkosti: viz. dodatek, obzvláště Příloha C1
 - 8 Teplotní odolnost spoje: viz. dodatek, obzvláště Příloha C1**Bezpečnost v případě požáru (BWR 2)**
 - 9 Odolnost proti ohni: Třída (A1)**Hygiena, zdraví a životní prostředí (BWR 3)**
 - 10 Formaldehyd: Lepidlo neobsahuje přidaný formaldehyd
8. Příslušná technická dokumentace a/nebo specifická technická dokumentace: -

Vlastnosti výše uvedeného výrobku jsou ve shodě se souborem deklarovaných vlastností. Toto prohlášení o vlastnostech se v souladu s nařízením (EU) č. 305/2011 vydává na výhradní odpovědnost výrobce uvedeného výše.

Podepsáno za výrobce a jeho jménem:



Dr. Ronald Mihala, Vedoucí oddělení vývoje a řízení výroby
Tumlingen, 2024-09-27



Jürgen Grün, Výkonný ředitel pro chemii a kvalitu

Toto PoV bylo připraveno v různých jazykových mutacích. V případě rozporu vždy rozhoduje interpretace verze v anglickém jazyce.

Příloha obsahuje nepovinné a doplňkové informace v anglickém jazyce nad rámec zákonných požadavků.

Translation guidance Essential Characteristics and Performance Parameters for Annexes

Pokyny pro překlad Základní charakteristiky a výkonnostní parametry příloh

Mechanical resistance and stability (BWR 1)

Mechanická odolnost a stabilita (BWR 1)

Characteristic resistance to tension load (static and quasi-static loading) Method A:

1	Bond strength in longitudinal tensile strength: Pevnost spoje při podélném tahovém smyku:	$f_{v,ltts,Ax,mean}$ [MPa]
2	Resistance to delamination: Odolnost proti delaminaci:	D [%]
3	Effect of wood shrinkage on the shear strength: Vliv smrštění dřeva na smykovou pevnost:	$f_{v,ws,mean}$ [MPa]
4	Effect of compression shear and climatic changes: Vliv tlakového smyku a klimatických změn:	$w_{cr,mean}$ [mm]
5	Bond shear strength of glued-in steel rods: Smyková pevnost zalepených ocelových tyčí:	$f_{vr,la,tB,k}$ [MPa]
6	Duration of load: Doba zatížení:	$k_{mod,LDY,SCX}$ [-]
7	Bond creep rupture test at very high and low moisture content: Krychová zkouška spojení při velmi vysokém a nízkém obsahu vlhkosti:	n_{unbrok} [-]
8	Bond temperatur resistance: Teplotní odolnost spoje:	$f_{vr,la,tB,res,k}$ [MPa]
Safety in case of fire (BWR 2)		
Bezpečnost v případě požáru (BWR 2)		
9	Reaction to fire: Odolnost proti ohni:	Class
Hygiene, health and the environment (BWR 3)		
Hygiena, zdraví a životní prostředí (BWR 3)		
10	Formaldehyde: Formaldehyd:	Class

Specific Part

1 Technical description of the product

The "fischer injection system FIS EM Plus" is an adhesive system consisting of an adhesive cartridge with injection system fischer FIS EM Plus and a steel rod.

The steel rod is inserted into a borehole, whereby the adhesive is either injected into the borehole before the steel rod is inserted (Direct Injection) or the annular gap is then filled with adhesive (By-Pass Injection). Once the adhesive has hardened, the steel rod is permanently anchored by the bond between the steel, adhesive and wood.

The load bearing timber connections with glued-in steel rods consist of

- the FIS EM Plus 2-component epoxy resin adhesive in accordance with the specifications deposited at DIBt,
- steel rods,
 - ribbed reinforcing steel rods in accordance with EN 10080¹ and a nominal diameter d of $6 \text{ mm} \leq d \leq 32 \text{ mm}$ or
 - metallic threaded rods with metric thread made of carbon steel with strength classes 4.8 to 12.9 in accordance with EN ISO 898-1² or made of stainless steel with strength classes 50 to 80 in accordance with EN ISO 3506-1³ with a nominal diameter d of $6 \text{ mm} \leq d \leq 30 \text{ mm}$, e.g., fischer anchor rod FIS A.

Depending on the service environment the metallic threaded rods are made of stainless steel with the appropriate corrosion resistance class in accordance with EN 1993-1-4⁴, for example fischer R-steel (CRC III) or fischer HCR-steel (CRC V).

- and timber members made from the following timber materials
 - glued laminated timber and glued solid timber in accordance with EN 14080⁵.

The steel rods are glued into timber structures of the wood species spruce (*Picea abies*), fir (*Abies alba*) or pine (*Pinus sylvestris*).

2 Specification of the intended use in accordance with the applicable European Assessment Document

The performances given in Section 3 are only valid if the anchor is used in compliance with the specifications and conditions given in Annex B.

The verifications and assessment methods on which this European Technical Assessment is based lead to the assumption of a working life of the anchor of at least 50 years. The indications given on the working life cannot be interpreted as a guarantee given by the producer, but are to be regarded only as a means for choosing the right products in relation to the expected economically reasonable working life of the works.

1	EN 10080:2005-08	Steel for the reinforcement of concrete - Weldable reinforcing steel - General
2	EN ISO 898-1:2013-05	Mechanical properties of fasteners made of carbon steel and alloy steel - Part 1: Bolts, screws and studs with specified property classes - Coarse thread and fine pitch thread
3	EN ISO 3506-1:2020-08	Fasteners - Mechanical properties of corrosion-resistant stainless steel fasteners - Part 1: Bolts, screws and studs with specified grades and property classes
4	EN 1993-1-4:2015-10	Eurocode 3: Design of steel structures - Part 1-4: General rules - Supplementary rules for stainless steels
5	EN 14080:2013-09	Timber structures - Glued laminated timber and glued solid timber - Requirements

3 Performance of the product and references to the methods used for its assessment

3.1 Mechanical resistance and stability (BWR 1)

Essential characteristic	Performance
Bond strength in longitudinal tensile shear strength	See Annex C1
Resistance to delamination	See Annex C1
Effect of wood shrinkage on the shear strength	See Annex C1
Effect of compression shear and climatic changes	See Annex C1
Bond shear strength of glued-in steel rods	See Annex C1
Duration of load	No performance assessed
Bond creep rupture test at very high and low moisture content	See Annex C1
Bond temperature resistance	See Annex C1

3.2 Safety in case of fire (BWR 2)

Essential characteristic	Performance
Reaction to fire	See Annex C1

3.3 Hygiene, health and the environment (BWR 3)

Essential characteristic	Performance
Formaldehyde	Adhesive contains no added formaldehyde

4 Assessment and verification of constancy of performance (AVCP) system applied, with reference to its legal base

For the products covered by this EAD the applicable European legal act is Commission Decision 97/176/EC, as amended by Commission Decision 2001/596/EC.

The system is 3.

5 Technical details necessary for the implementation of the AVCP system, as provided for in the applicable EAD

Technical details necessary for the implementation of the AVCP system are laid down in the control plan deposited with Deutsches Institut für Bautechnik.

By-Pass Injection (BPI)

Pre-positioned installation (installation of the fastener before mounting the fixture)

**fischer
Anchor rod FIS A
and
commercial
standard
threaded rod**

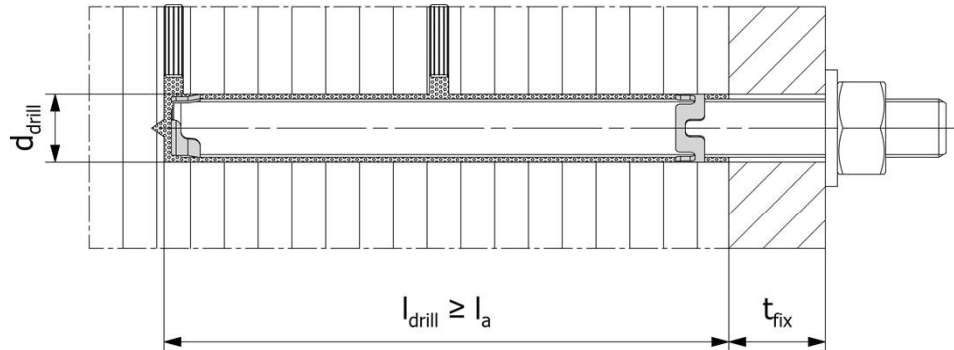

**Ribbed
reinforcing steel**

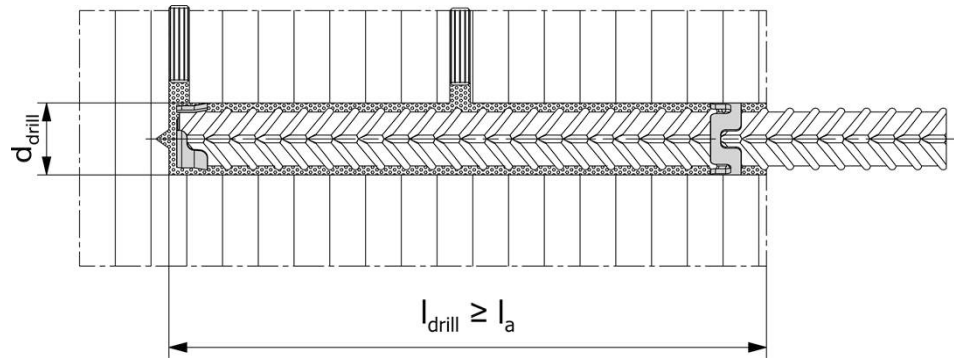

Push through installation (installation of the fastener through the positioned fixture)

**fischer
Anchor rod FIS A
and
commercial
standard
threaded rod**

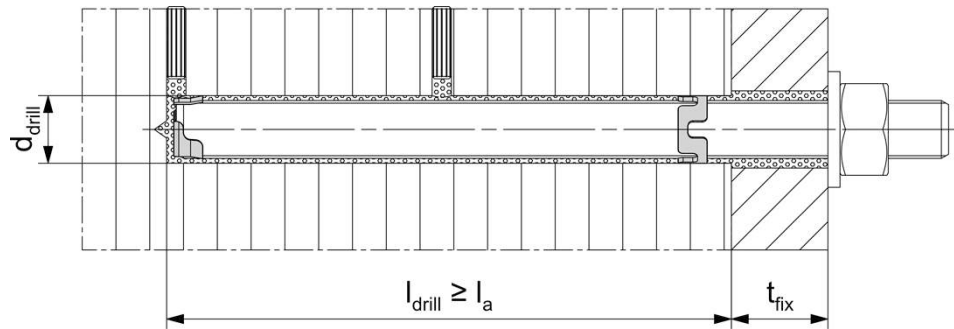

Figures not to scale

l_{drill} = drill hole depth

d_{drill} = drill hole diameter

l_a = Nominal bonded length of the glued-in rods

t_{fix} = thickness of fixture

fischer injection system FIS EM Plus

Product description

Annex A1

Appendix 3 / 16

Direct Injection (DI)

Pre-positioned installation (installation of the fastener before mounting the fixture)

**fischer
Anchor rod FIS A
and
commercial
standard
threaded rod**

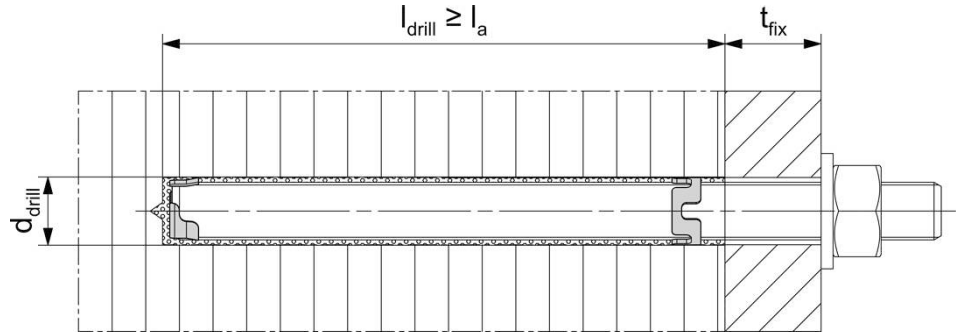

**Ribbed
reinforcing steel**

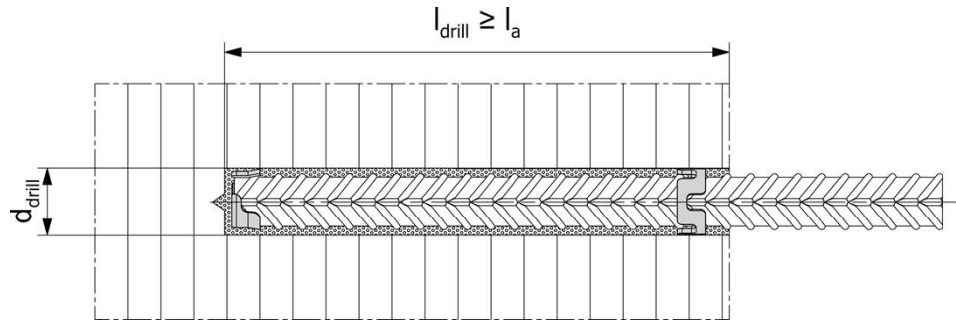

Push through installation (installation of the fastener through the positioned fixture)

**fischer
Anchor rod FIS A
and
commercial
standard
threaded rod**

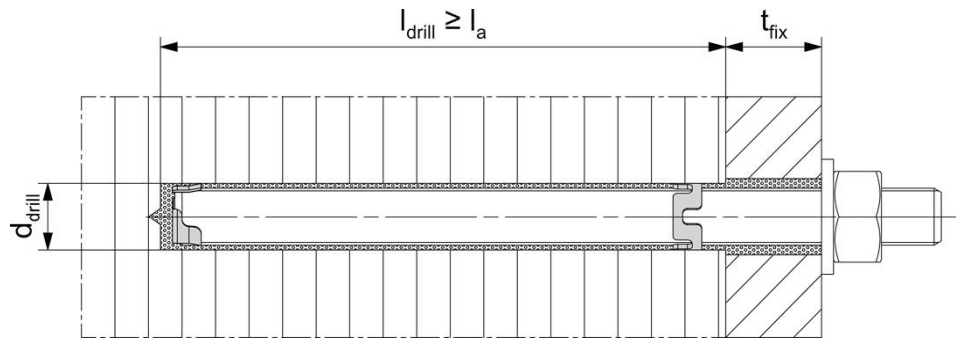

Figures not to scale

l_{drill} = drill hole depth

d_{drill} = drill hole diameter

l_a = Nominal bonded length of the glued-in rods

t_{fix} = thickness of fixture

fischer injection system FIS EM Plus

Product description

Annex A2

Appendix 4 / 16

Direct Injection (DI)

Subsequent injection of the annular gap in the fixture (optional)

Pre-positioned or push through installation with subsequently injected fischer filling disc FFD (annular gap filled with mortar)

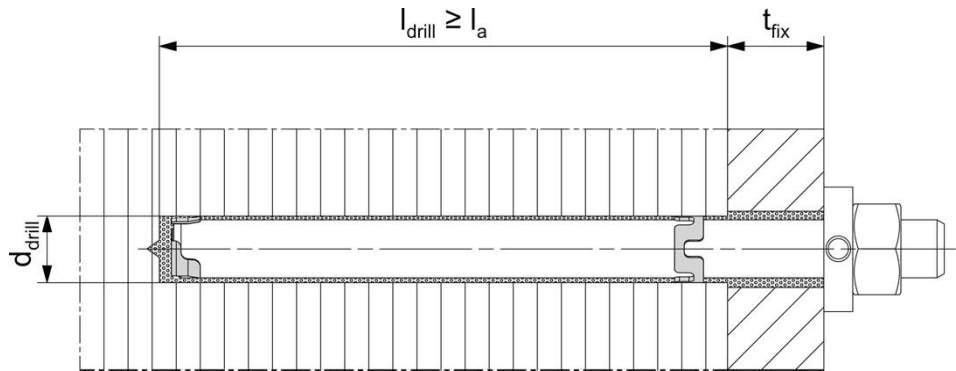

The fischer filling disc FFD can be used instead of a washer in all installation conditions and allows the annular gap to be subsequently injected with adhesive.

By-Pass Injection (BPI)

Concealed installation, joining of timber structures

fischer Anchor rod FIS A and commercial standard threaded rod

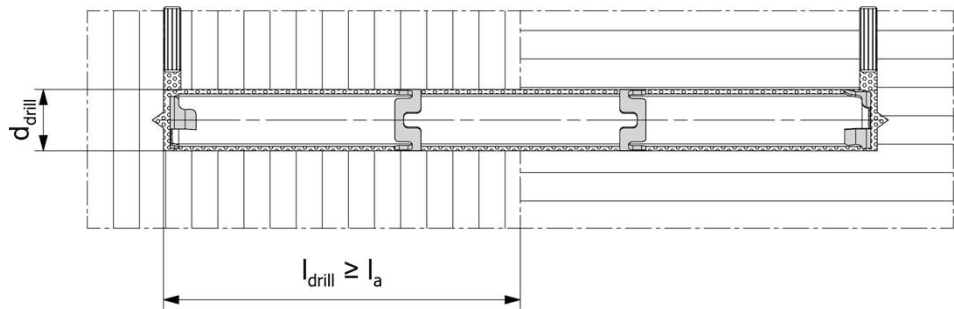

Ribbed reinforcing steel

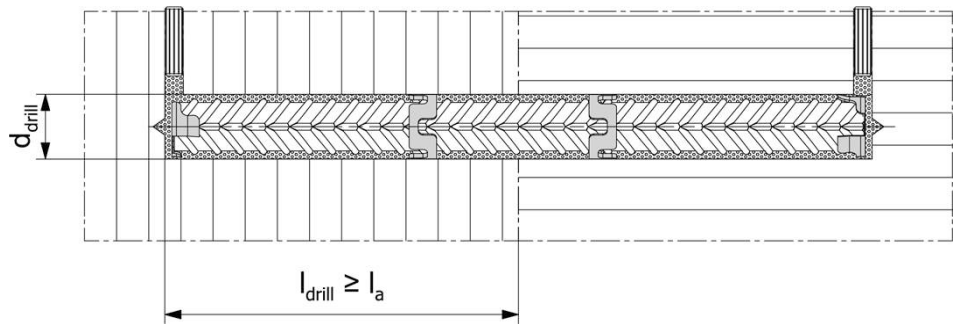

Figures not to scale

l_{drill} = drill hole depth

l_a = Nominal bonded length of the glued-in rods

d_{drill} = drill hole diameter

t_{fix} = thickness of fixture

fischer injection system FIS EM Plus

Product description

Annex A3

Appendix 5 / 16

By-Pass Injection (BPI)

Concealed installation, reinforcement of timber structures

Fischer Anchor rod FIS A and commercial standard threaded rod

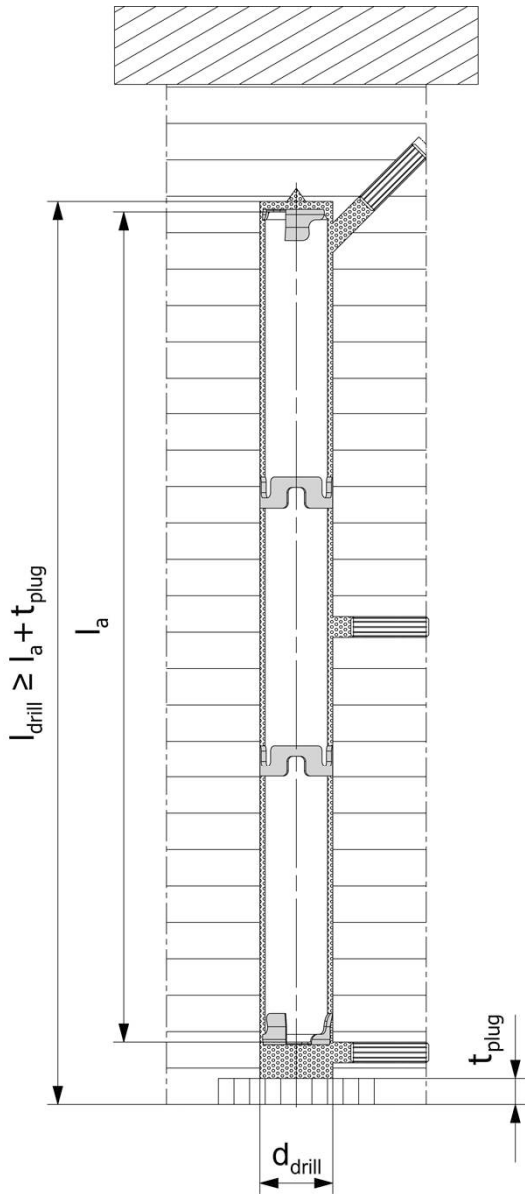

Ribbed reinforcing steel

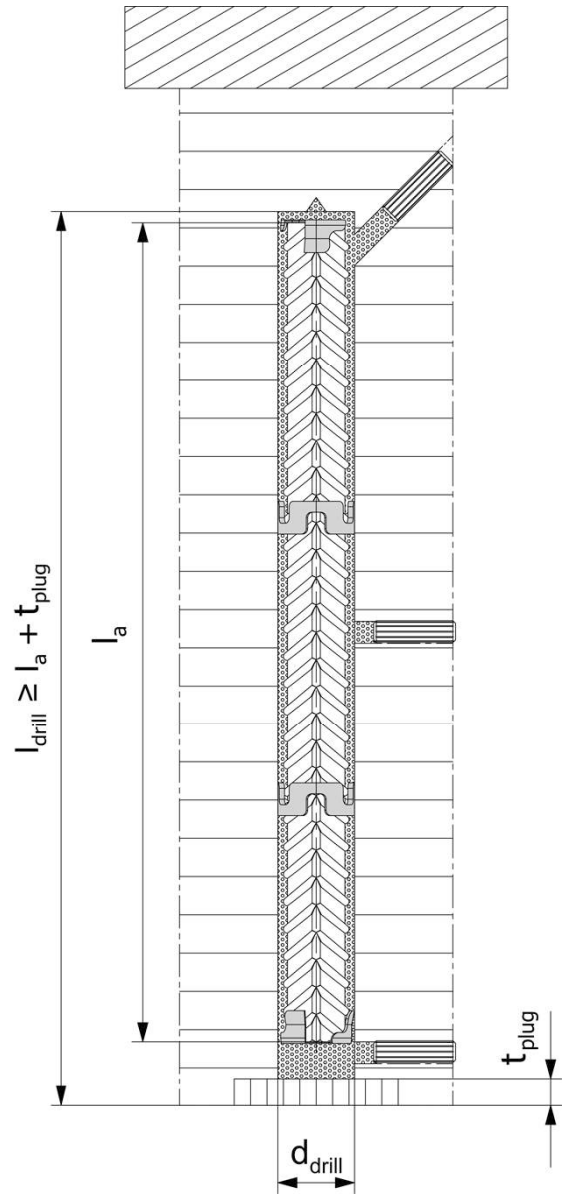

Alternatively, the injection hole at the drill hole bottom can also be drilled at right angles to the wood surface.

Figures not to scale

l_{drill} = drill hole depth

d_{drill} = drill hole diameter

l_a = Nominal bonded length of the glued-in rods

t_{plug} = Thickness of the wooden closing plug / flat head plug

fischer injection system FIS EM Plus

Product description

Annex A4

Appendix 6 / 16

Injection cartridge (shuttle cartridge) with sealing cap; Size: 390 ml, 585 ml, 1500 ml

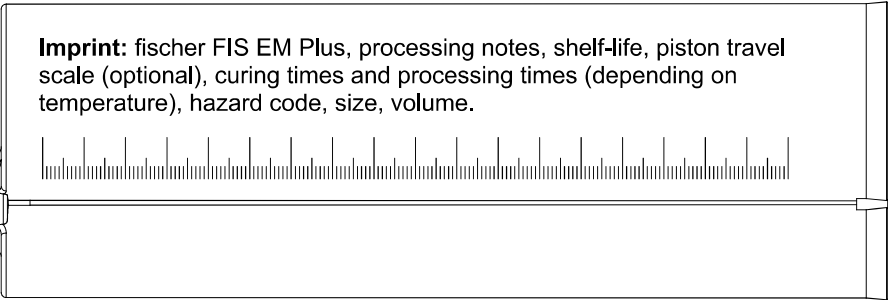
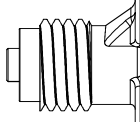
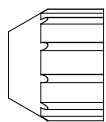

Injection cartridge (coaxial cartridge) with sealing cap; Size: 300 ml

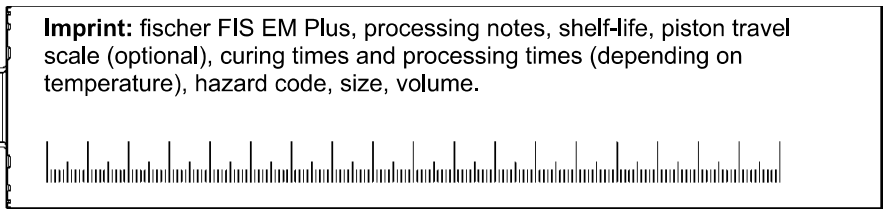
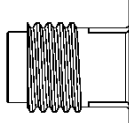
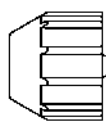

Static mixer FIS MR Plus for injection cartridges ≤ 585 ml

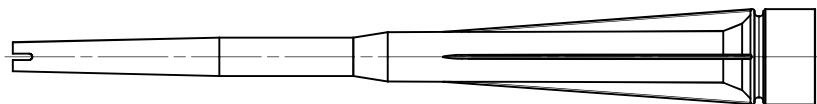

Static mixer FIS UMR for injection cartridges ≥ 390 ml

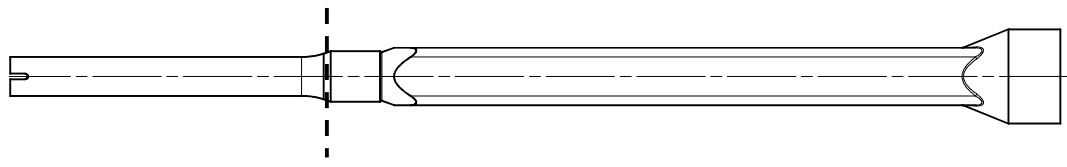

When using the Ø 15 extension tube, cut it off here and remove the front section.

**Injection adapter and extension tube Ø 9 for static mixer FIS MR Plus;
Injection adapter and extension tube Ø 9 or Ø 15 for static mixer FIS UMR**

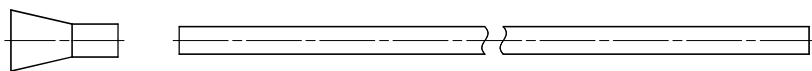

Figures not to scale

fischer Anchor rod FIS A and commercial standard threaded rod

Size: M6 to M30

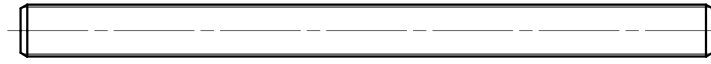

Washer / hexagon nut

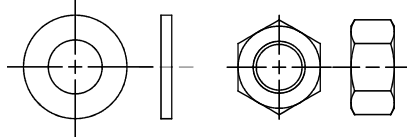

fischer filling disc FFD with injection adapter (for optional injection of the annular gap in the fixture)

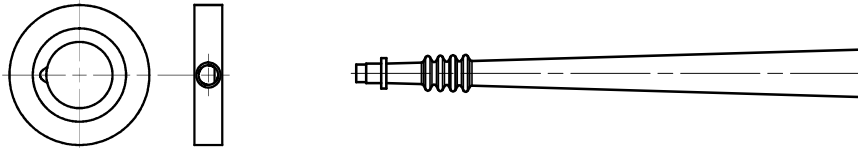

Ribbed reinforcing steel

Nominal diameter: d6 to d32



fischer centering clip DD-S / DD-E



Cleaning brush BS / BSB (for optional additional drill hole cleaning)



Compressed-air cleaning tool ABP

Cleaning tube

Compressed-air nozzle (optional)



Figures not to scale

fischer injection system FIS EM Plus

Product description

Annex A6
Appendix 8 / 16

Installation instructions

General information



Wear protective goggles.



Wear hand protection.



Wear protective clothing.

For details on personal protective equipment, see safety data sheet.

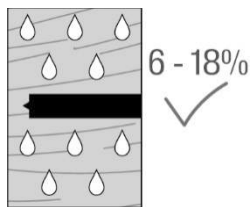

Wood moisture content $6 \% \leq u \leq 18 \%$

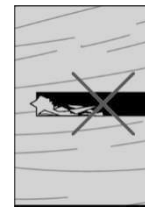
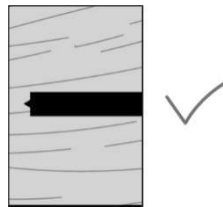

Installation only permitted in a cleaned drill hole.

By-Pass Injection (BPI): Drilling and cleaning the hole

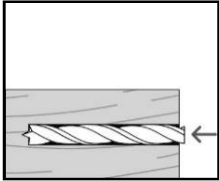
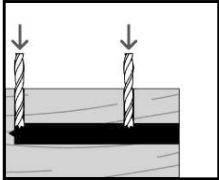
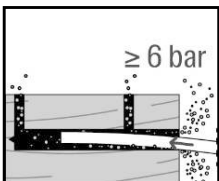
1		<p>Drill the hole. Drill hole depth $l_{\text{drill}} \geq l_a$. When using the DD-E centring clips, increase the drill hole depth accordingly.</p>
2		<p>Drill injection holes. Adapt the drill hole diameter $d_{\text{drill,BPI}}$ to the static mixer: FIS MR Plus: 8 mm (to be preferred) FIS UMR: 10 mm</p> <p>Use of the static mixer FIS MR Plus is recommended, as the conical tip achieves a better seal to the injection hole.</p>
3		<p>Cleaning the drill hole: Blow out the drill hole using oil-free compressed air ($p \geq 6 \text{ bar}$) until no more drill dust escapes. If necessary, use a cleaning tube with a compressed-air cleaning tool.</p> <p>Optionally, the drill hole can additionally be cleaned by brushing out and then blowing out.</p>





fischer injection system FIS EM Plus

Specifications of intended use

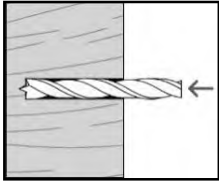
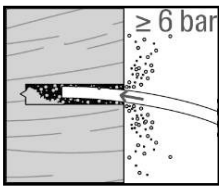

Annex B1
 Appendix 9 / 16

Direct Injection (DI): Drilling and cleaning the hole

1		<p>Drill the hole. Drill hole depth $l_{\text{drill}} \geq l_a$. When using the DD-E centring clips, increase the drill hole depth accordingly.</p>
2		<p>Cleaning the drill hole: Blow out the drill hole using oil-free compressed air ($p \geq 6 \text{ bar}$) until no more drill dust escapes. If necessary, use a cleaning tube with a compressed-air cleaning tool. Optionally, the drill hole can additionally be cleaned by brushing out and then blowing out.</p> 

Go to step 4

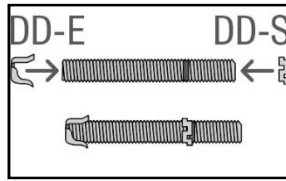
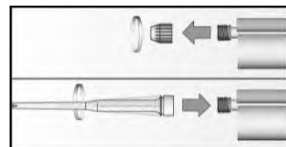
Preparing the cartridge and the steel rods

4		<p>Prepare the steel rod. Only use clean and oil-free steel rods. Dirt must be removed mechanically or chemically if necessary. Mark the required glue-in length, taking into account the thickness of the fixture t_{fix} for push through installation. Attach centring devices, e.g. fischer centring clip DD-S / DD-E.</p>
5		<p>Remove the sealing cap. Screw on the static mixer (the spiral in the static mixer must be clearly visible).</p>
6		<p>Place the cartridge into the dispenser.</p>
7		<p>Extrude approximately 10 cm of material out until the adhesive is evenly grey in colour. Do not use mortar that is not uniformly grey.</p>

fischer injection system FIS EM Plus

Specifications of intended use

Annex B2

Appendix 10 / 16

Direct Injection (DI), pre-positioned / push through installation: Adhesive injection and installation of the steel rods

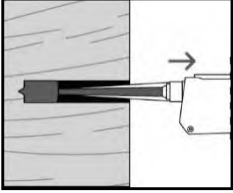
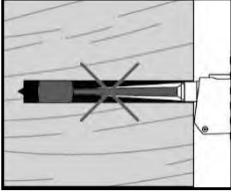
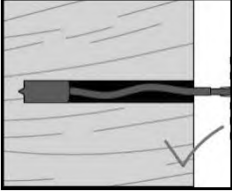
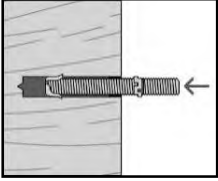
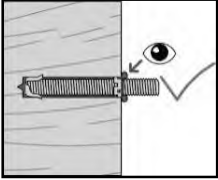
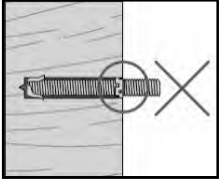
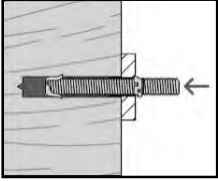
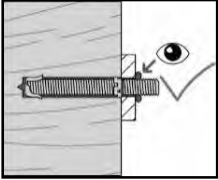
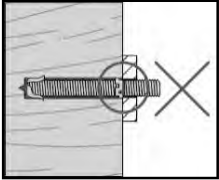
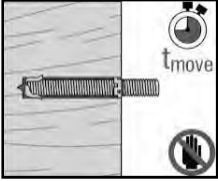
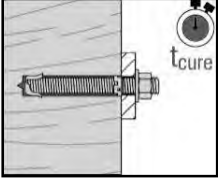
<p>8</p>			 <p>If the length of the static mixer is insufficient, a suitable extension tube must be used. For overhead installation, deep drill holes ($l_{\text{drill}} > 250 \text{ mm}$) or large drill hole diameters ($d_{\text{drill}} \geq 30 \text{ mm}$) use an injection-adapter.</p>
<p>9a</p>	  	<p><u>Pre-positioned installation</u></p> <p>Do not exceed the processing time according to Table B7.1. Introduce the steel part into the drill hole until the required glue-in length is reached.</p> <p>After setting the steel rods, excess adhesive must have emerged from the mouth of the drill hole. If not, pull the steel rod immediately and reinject adhesive. Go to step 10</p>	
<p>9b</p>	  	<p><u>Push through installation</u></p> <p>Do not exceed the processing time according to Table B7.1. Introduce the steel part into the drill hole until the required glue-in length is reached.</p> <p>After setting the steel rods, excess adhesive must have emerged from the annular gap. If not, pull the steel rod immediately and reinject adhesive. Go to step 10</p>	
<p>10</p>		<p>Period of time during which the members with glued-in steel rods must not be moved (t_{move}) according to Table B7.1 must be observed.</p>	
<p>11</p>		<p>After the period of time until the adhesive has reached its final joint strength at $T \leq 60 \text{ °C}$ (t_{cure}) in accordance with Table B7.2, install the fixture.</p>	

fischer injection system FIS EM Plus

Specifications of intended use

Annex B3

Appendix 11 / 16

By-Pass Injection (BPI), pre-positioned / push through installation: Adhesive injection and installation of the steel rods

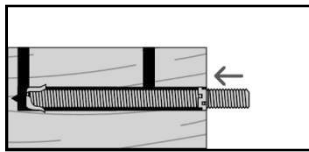
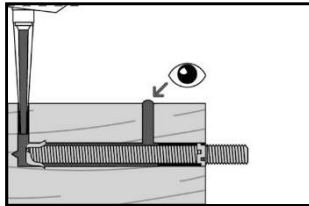
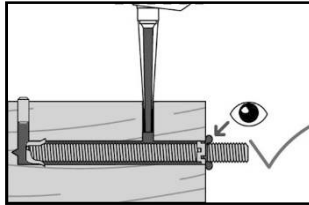
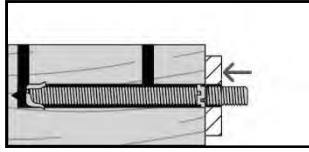
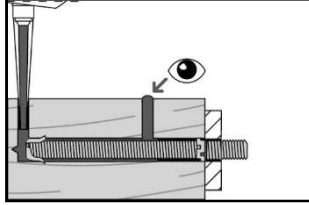
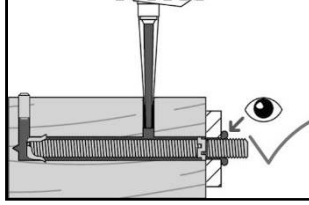
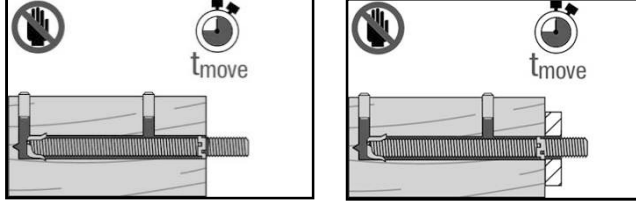
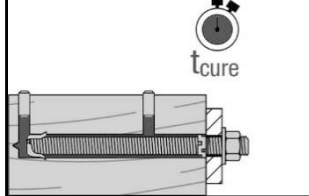
8a		<p><u>Pre-positioned installation</u></p> <p>Introduce the steel part into the drill hole until the required glue-in length is reached.</p>
9a		<p>Insert the static mixer sufficiently deep and firmly into the injection hole to prevent adhesive from leaking. Start injection from the bottom of the drill hole. Continue injection until adhesive emerges at the next injection hole or at the mouth of the drill hole (if only one injection hole is used). Do not exceed the processing time according to Table B7.1.</p>
10a		<p>Close the last injection hole used with a suitable wooden dowel / flat head plug and continue injection at the next injection hole. Closing the last injection hole is optional. At the end of the injection process, adhesive must have emerged from the mouth of the drill hole. Go to step 11</p>
8b		<p><u>Push through installation</u></p> <p>Introduce the steel part into the drill hole until the required glue-in length is reached.</p>
9b		<p>Insert the static mixer sufficiently deep and firmly into the injection hole to prevent adhesive from leaking. Start injection from the bottom of the drill hole. Continue injection until adhesive emerges at the next injection hole or at the annular gap (if only one injection hole is used). Do not exceed the processing time according to Table B7.1.</p>
10b		<p>Close the last injection hole used with a suitable wooden dowel / flat head plug and continue injection at the next injection hole. Closing the last injection hole is optional. At the end of the injection process, adhesive must have emerged from the annular gap. Go to step 11</p>
11		<p>Period of time during which the members with glued-in steel rods must not be moved (t_{move}) according to Table B7.1 must be observed.</p>
12		<p>After the period of time until the adhesive has reached its final joint strength at $T \leq 60 \text{ }^\circ\text{C}$ (t_{cure}) in accordance with Table B7.2, install the fixture.</p>

fischer injection system FIS EM Plus
Specifications of intended use

By-Pass Injection (BPI), Concealed installation: Adhesive injection and installation of the steel rods

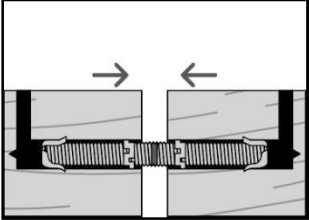
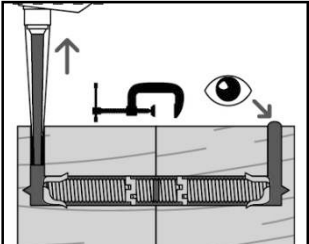
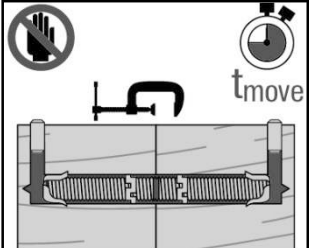
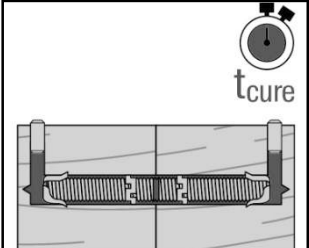
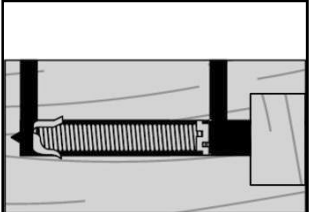
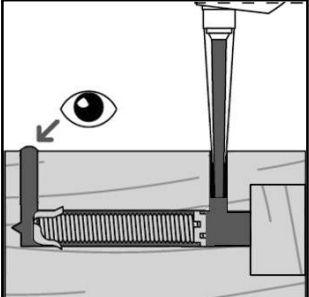
8a		<p><u>Joining of timber structures</u></p> <p>Introduce the steel part into the drill hole until the required glue-in length is reached. Position the second timber member and join the members. Clamp / fix together the parts. Prevent adhesive from leaking at the joint gap, additionally seal the joint gap if necessary.</p>
9a		<p>Insert the static mixer sufficiently deep and firmly into the injection hole to prevent adhesive from leaking. Start injection from the bottom of the drill hole. Continue injection until adhesive emerges from the next injection hole or the opposing injection hole (if only one injection hole is used). If several injection holes are used, close the last used injection hole with a suitable wooden dowel / flat head plug and continue injection at the next hole. Closing the last injection hole is optional. Do not exceed the processing time according to Table B7.1.</p>
10a		<p>Period of time during which the members with glued-in steel rods must not be moved (t_{move}) according to Table B7.1 must be observed. Do not remove the part fixation until t_{move} is reached.</p>
11a		<p>After the period of time until the adhesive has reached its final joint strength at $T \leq 60 \text{ }^\circ\text{C}$ (t_{cure}) in accordance with Table B7.2, the assembled structural component may be fully loaded.</p>
8b		<p><u>Reinforcement of timber structures</u></p> <p>Introduce the steel part into the drill hole until the required glue-in length is reached. For overhead installations support the steel rod with wedges (e.g., fischer centering wedges) or fix by driving in e.g. a wooden closing plug / flat head plug.</p>
9b		<p>For vertical installation, the injection direction from bottom to top is preferable. Insert the static mixer sufficiently deep and firmly into the injection hole to prevent adhesive from leaking. Continue injection until adhesive emerges from the next injection hole. If several injection holes are used, close the last used injection hole with a suitable wooden dowel / flat head plug and continue injection at the next hole. Closing the last injection hole is optional. Do not exceed the processing time according to Table B7.1. Observe times t_{move} and t_{cure} analogue to installation steps 10a and 11a.</p>

fischer injection system FIS EM Plus	Annex B5 Appendix 13 / 16
Specifications of intended use	

Annex B6 Specifications of intended use part 1

B6.1 General

Use of fischer adhesive system FIS EM Plus only for:

- non-fatigue static and quasi-static loads.

B6.2 Installation provisions

EN 1995-1-1¹ applies for the installation.

Load-bearing timber connections with glued-in steel rods produced using the FIS EM Plus adhesive shall only be used inside buildings and for roofed members where a relative humidity of 85 % is only exceeded for a few weeks per year (service classes 1 and 2 in accordance with DIN EN 1995-1-1). The fitness for application of the connections produced with the adhesive has been verified up to a member temperature of 60 °C.

Gluing steel rods into load-bearing timber structures which have been treated or are treated with chemical wood preservatives or fire retardants is not the subject of this ETA.

For metallic threaded rods, the diameter of the borehole shall be at least 2.0 mm but no more than 4.0 mm larger than the nominal diameter of the steel rods. The drill hole is cleaned by blowing out with compressed air before the steel rods are glued in.

From a slimmess of the metallic threaded rod of $l_a/d > 30$, the borehole diameter shall be at least 3 mm but no more than 4 mm larger than the nominal diameter of the steel rods.

For ribbed reinforcing steel rods, the diameter of the borehole shall correspond to the values in Table B6.1, unless measurements made on the ribbed reinforcing steel rods used show smaller external diameters. If this is the case, the following shall apply:

External diameter of the ribbed reinforcing steel rods + 2.0 mm up to + 4.0 mm, but not more than nominal diameter + 5.5 mm for nominal diameters > 25 mm.

Table B6.1: Borehole diameter for ribbed reinforcing steel rods

Nominal diameter d of ribbed reinforcing steels rods in mm	Borehole diameter in mm
$6 \leq d \leq 16$	$d + 3 -0.5/+1$
$16 < d \leq 20$	$d + 3.5 \pm 0.5$
$20 < d \leq 27$	$d + 4.5 \pm 0.5$
$27 < d \leq 32$	$d + 5.5$

By using suitable structural measures (e.g. fischer centering clips) it shall be ensured that the steel rods are centrally glued into the borehole.

If the borehole is filled with adhesive beforehand and the steel rod is subsequently inserted, it shall be considered that there may be a delay in the release of trapped bubbles. In this case, refilling is necessary. Introducing the adhesive into the borehole by means of By-Pass injection largely avoids the inclusion of bubbles. It shall be ensured that the adhesive does not escape while curing. If the adhesive escapes from the borehole, refilling is necessary. Refilling shall take place within the times specified in Table B7.1, Line 2.

¹ EN 1995-1-1:2004+A1:2008+A2:2014 Eurocode 5: Design of timber structures - Part 1-1: General - Common rules and rules for buildings

fischer injection system FIS EM Plus

Specifications of intended use

Annex B6
Appendix 14 / 16

Annex B7 Specifications of intended use part 2

The total glue-in length of the steel rods l_{glue} shall not exceed 3,000 mm; the rod slimmess shall be $l_{glue}/d < 110$.

Where:

d Nominal diameter of steel rods in mm

l_{glue} Total glued-in length of the steel rods.

The steel rods shall only be glued into timber members that have a moisture content of 6 % to 18 %. During the gluing process, the temperature of the timber members, the steel rods and the adhesive shall be at least 17 °C. The fitness for use of the adhesive has been verified up to a temperature of 40 °C of the timber members into which the steel rods are to be inserted using the adhesive. The room temperature during gluing and curing shall be at least 17 °C.

To avoid condensation, adequate air conditioning shall be provided for all components, explicitly for the steel rods to be installed.

B7.1 Working properties

During the installation process, the respective period of time for introducing and aligning the steel rod as well as the period of time during which the members with glued-in steel rods must not be moved shall be observed in accordance with Table B7.1.

Table B7.1: Period of time for introducing and aligning the steel rod as well as period of time during which the members with glued-in steel rods must not be moved, depending on the room temperature and the temperature of the timber members

Room temperature and temperature of the timber members with glued-in steel rods during installation	17 to < 20 °C	20 to < 30 °C	30 to ≤ 40 °C
Maximum period of time for introducing the steel rod into the borehole filled with adhesive and aligning it after filling of the borehole has been started	30 min	14 min	7 min
Period of time during which the members with the glued-in steel rods must not be moved	8.5 h	4.75 h	3.15 h

The requirements of Table B7.2 for the period of time until the adhesive has reached its final joint strength shall be complied with.

Table B7.2: Period of time until the adhesive has reached its final joint strength depending on the room temperature and the temperature of the timber members

Room temperature and temperature of the timber members with glued-in steel rods during curing	17 bis < 20 °C	20 bis < 30 °C	30 bis ≤ 40 °C
Period of time until the adhesive has reached its final joint strength at $T \leq 60$ °C ¹	36 h	18 h	12 h

¹ After this period of time, the maximum member temperature to which the load-bearing connections with glued-in steel rods may be exposed is 60 °C.

B7.2 Design regulations (informative)

EOTA Technical Report TR 070² can be applied for the design of glued-in steel rods for timber connections.

² EOTA Technical Report TR 070:2019 "Design of glued-in Rods for Timber Connections"

fischer injection system FIS EM Plus	Annex B7 Appendix 15 / 16
Specifications of intended use	

Annex C1 Essential characteristics

C1.1 Mechanical resistance and stability (BWR 1)

Table C1.1: Essential characteristics of fischer injection system FIS EM Plus

Essential characteristic	Performance	Assessment method
Bond strength in longitudinal tensile shear strength	Passed $f_{v,lts,Ax,mean} \geq f_{v,lts,Ax,mean,min}$	EN 17334, Clause 7.3.1
Resistance to delamination	Passed $D \leq 5 \%$	EN 17334, Clause 7.3.2
Effect of wood shrinkage on the shear strength	Passed $f_{v,ws,mean} \geq 1.5 \text{ N/mm}^2$	EN 17334, Clause 7.3.3
Effect of compression shear and climatic changes	Passed $w_{cr,mean} \leq 0.05 \text{ mm}$	EN 17334, Clause 7.3.4
Bond shear strength of glued-in steel rods	$I_a \leq 250 \text{ mm}$: $f_{vr,k} = 4.0 \text{ N/mm}^2$ $250 \text{ mm} < I_a \leq 500 \text{ mm}$: $f_{vr,k} = 5.25 - 0.005 \cdot I_a \text{ N/mm}^2$ $500 \text{ mm} < I_a \leq 1000 \text{ mm}$: $f_{vr,k} = 3.5 - 0.0015 \cdot I_a \text{ N/mm}^2$	EN 17334, Clause 8, and Clause 2.2.1 of EAD
Duration of load	k_{def} and k_{mod} according to EN 1995-1-1	
Bond creep rupture test at very high and low moisture content	Passed $n_{unbrok} = 5$, no increased creep behavior, no failure	EN 17334, Clause 10, and Clause 2.2.1 of EAD
Bond temperature resistance	Passed $f_{vr,res,k} \geq f_{vr,k}$	EN 17334, Clause 9, and Clause 2.2.1 of EAD

C1.2 Safety in case of fire (BWR 2)

Fire performance

The performance of the metallic threaded rods made of steel and the weldable reinforcing steel rods is class A1.

The adhesive (thickness $\leq 3 \text{ mm}$) is located between the rod and the timber element and embedded in the timber element (minimum edge distance of at least $2.5 \cdot d$) in the end use. Therefore, it shall be assumed in the context of the intended use that the contribution of the adhesive in connection with the glued-in rods in the end use application is very small and does not affect the reaction to fire performance of the timber in which the rods are glued-in. Therefore, reaction to fire performance of the adhesive shall be considered as negligible and does not need to be tested.

fischer injection system FIS EM Plus

Essential characteristics

Annex C1
Appendix 16 / 16