

PROHLÁŠENÍ O VLASTNOSTECH

DoP 0197

pro svorníková kotva fischer FH II, FH II-I (Kovové kotvy do betonu)

CS

1. <u>Jedinečný identifikační kód typu výrobku:</u>	DoP 0197		
2. <u>Zamýšlené/zamýšlená použití:</u>	Dodatečné upevnění v tažené a tlačené zóně betonu.		
3. <u>Výrobce:</u>	Viz. dodatek, obzvláště Přílohy B1- B6		
4. <u>Zplnomocněný zástupce:</u>	fischerwerke GmbH & Co. KG, Klaus-Fischer-Str. 1, 72178 Waldachtal, Německo		
5. <u>Systém/systémy POSV:</u>	1		
6. <u>Evropský dokument pro posuzování:</u>	EAD 330232-00-0601 (Edition 10/ 2016)		
Evropské technické posouzení:	ETA-07/0025; 2020-09-23		
Subjekt pro technické posuzování:	DIBt- Deutsches Institut für Bautechnik		
Oznámený subjekt/oznámené subjekty:	1343 MPA Darmstadt / 2873 TU Darmstadt		
7. <u>Deklarovaná vlastnost/Deklarované vlastnosti:</u>			
Mechanická odolnost a stabilita (BWR 1)			
Charakteristická únosnost v tahu (pro statickou a kvazistatickou akci):	Odolnost proti selhání oceli: Odolnost proti selhání vytažením:	Přílohy C1, C2 Přílohy C1, C2	$E_s = 210\,000\text{ MPa}$
	Odolnost proti selhání betonu:	Přílohy C1, C2	
	Pevnost:	Přílohy C1, C2	
	Minimální vzdálenost od okraje a rozteč:	Přílohy C7	
	Okrajová vzdálenost bránící rozštěpení při zatížení:	Přílohy C1, C2	
	Posuny při statickém a kvazistatickém zatížení:	Přílohy C10, C11	
Charakteristická únosnost ve smyku (pro statickou a kvazistatickou akci):	Odolnost proti selhání oceli (smykové zatížení): Odolnost proti selhání rozštěpením: Odolnost proti selhání okraje betonu: Posuny při statickém a kvazistatickém zatížení:	Přílohy C3, C4 Přílohy C3, C4 Přílohy C3, C4 Přílohy C10, C11	
	Životnost:	Přílohy A4, B1	
Charakteristická únosnost a posuny pro seismické kategorie C1 a C2:	Odolnost proti selhání oceli: Odolnost proti selhání vytažením:	Přílohy C8, C9 Přílohy C8, C9	
	Mezní protažení:	>8%	
	Koeficient prstencové mezery:	Přílohy C8, C9	
	Posuny:	Přílohy C11	
Bezpečnost v případě požáru (BWR 2)			
Reakce na oheň:	Třída (A1)		
Odolnost proti požáru:	Požární odolnost proti selhání oceli (tahové) Požární odolnost proti selhání vytažením (tahové) Požární odolnost proti selhání oceli (smykové)	Přílohy C5 Přílohy C5 Přílohy C6	



8. Příslušná technická dokumentace a/nebo specifická technická dokumentace: -

Vlastnosti výše uvedeného výrobku jsou ve shodě se souborem deklarovaných vlastností. Toto prohlášení o vlastnostech se v souladu s nařízením (EU) č. 305/2011 vydává na výhradní odpovědnost výrobce uvedeného výše.

Podepsáno za výrobce a jeho jménem:

Thilo Pregartner, Dr.-Ing.
Tumlingen, 2020-10-06

Peter Schillinger, Dipl.-Ing.

Toto PoV bylo připraveno v různých jazykových mutacích. V případě rozporu vždy rozhoduje interpretace verze v anglickém jazyce.

Příloha obsahuje nepovinné a doplňkové informace v anglickém jazyce nad rámec zákonných požadavků.

Specific Part

1 Technical description of the product

The fischer High-Performance Anchor FH II, FH II-I is an anchor made of galvanised steel (sizes with external diameter 10, 12, 15, 18, 24, 28 and 32, sizes with internal thread 12/M6 I, 12/M8 I, 15/M10 I and 15/M12 I) or stainless steel (sizes with external diameter 10, 12, 15, 18 and 24, sizes with internal thread 12/M6 I, 12/M8 I, 15/M10 I and 15/M12 I) which is placed into a drilled hole and anchored by torque-controlled expansion.

The product description is given in Annex A.

2 Specification of the intended use in accordance with the applicable European Assessment Document

The performances given in Section 3 are only valid if the fastener is used in compliance with the specifications and conditions given in Annex B.

The verifications and assessment methods on which this European Technical Assessment is based lead to the assumption of a working life of the fastener of at least 50 years. The indications given on the working life cannot be interpreted as a guarantee given by the producer, but are to be regarded only as a means for choosing the right products in relation to the expected economically reasonable working life of the works.

3 Performance of the product and references to the methods used for its assessment

3.1 Mechanical resistance and stability (BWR 1)

Essential characteristic	Performance
Characteristic resistance to tension load (static and quasi-static loading)	See Annex C 1, C 2, C 7
Characteristic resistance to shear load (static and quasi-static loading)	See Annex C 3 and C 4
Displacements (static and quasi-static loading)	See Annex C 10, C 11
Characteristic resistance and displacements for seismic performance categories C1 and C2	See Annex C 8, C 9, C 11
Durability	See Annex B 1

3.2 Safety in case of fire (BWR 2)

Essential characteristic	Performance
Reaction to fire	Class A1
Resistance to fire	See Annex C 5, C 6

4 Assessment and verification of constancy of performance (AVCP) system applied, with reference to its legal base

In accordance with the European Assessment Document EAD 330232-01-0601 the applicable European legal act is: [96/582/EC].

The system to be applied is: 1

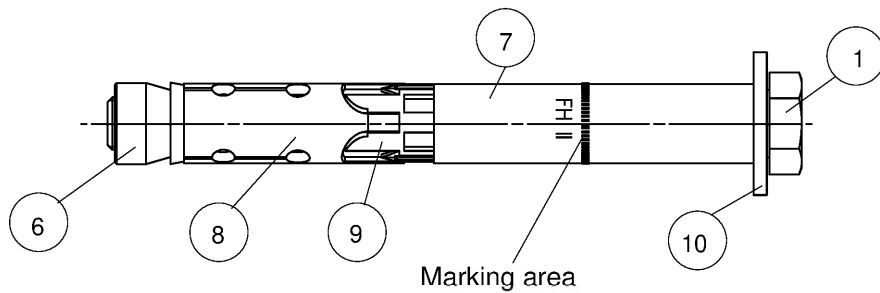

Type hexagon screw **S**
 FH II 10 - 32 S
 FH II 10 - 24 S R

Product label, example:  FH II 15/25 R



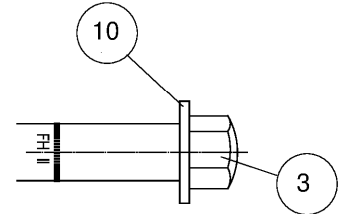
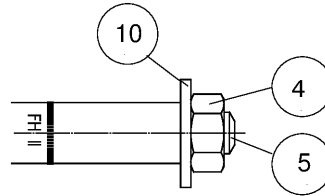
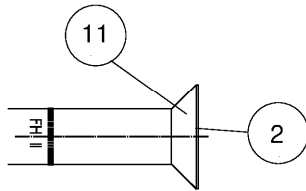









Brand _____ Identification R
 Type of fastener _____ Nominal drill hole diameter/max. thickness of fixture (t_{fix})



Type countersunk screw **SK**
 FH II 10 - 18 SK
 FH II 10 - 18 SK R

Type hexagon nut **B**
 FH II 10 - 32 B
 FH II 10 - 24 B R

Type cap nut **H**
 FH II 10 - 24 H
 FH II 10 - 24 H R

- | | | |
|---|--|--|
|  Hexagon screw |  Threaded rod |  Plastic sleeve |
|  Countersunk screw |  Cone nut |  Washer |
|  Cap nut |  Distance sleeve |  Conical washer |
|  Hexagon nut |  Expansion sleeve |  Internal thread socket |

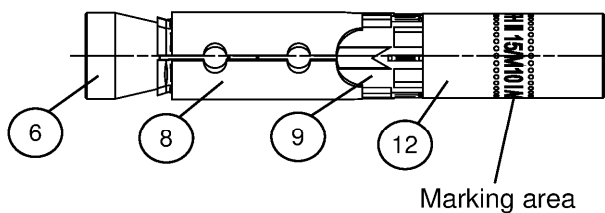

Type internal threaded anchor I
 FH II 12 M6-I or M8-I
 FH II 15 M10-I or M12-I

Product label, example:  FH II 12/M8-I R

Brand _____ Identification R
 Type of fastener _____ Nominal drill hole diameter / size of internal thread
(Fig. not to scale)

fischer High-Performance Anchor FH II, FH II-I

Product description
 Anchor types FH II, FH II R, FH II-I, FH II-I R

Annex A 1

Appendix 2/ 22

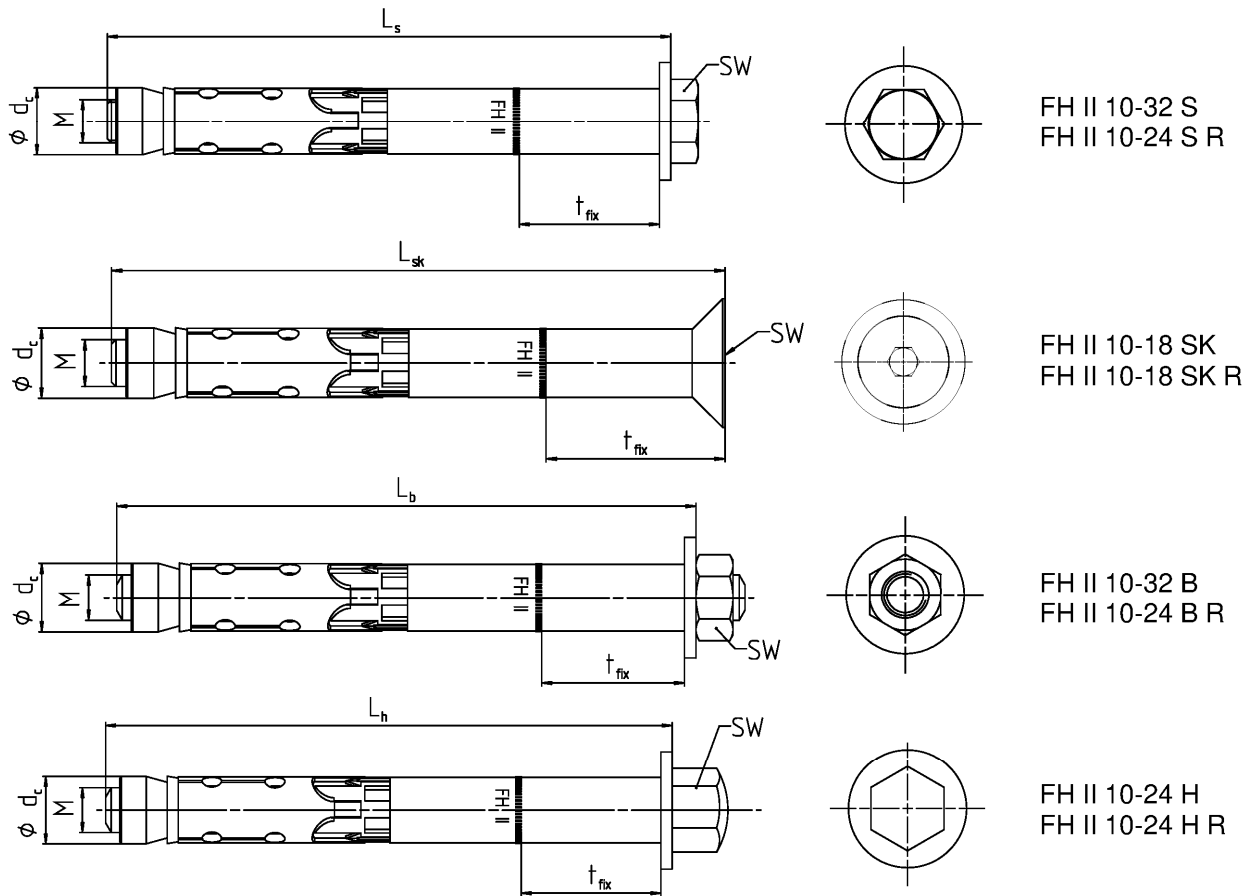

Table A2.1: Dimensions [mm] FH II and FH II R

Anchor type		FH II 10	FH II 12	FH II 15	FH II 18	FH II 24	FH II 28	FH II 32
Thread	M	6	8	10	12	16	20	24
Diameter cone nut	d_c	10	12	14,8	17,8	23,7	27,5	31,5
Wrench size SW	FH II-S, -B	10	13	17	19	24	30	36
	FH II-SK ¹⁾	4	5	6	8	3)		
	FH II-H	13	17	17	19	24	3)	
	FH II-S R, -B R, -H R	10	13	17	19	24	3)	
	FH II-SK R ¹⁾	4	5	6	8	3)		
t_{fix} FH II-S, -B, -H + FH II-S R, -B R, -H R	min	0	0	0	0	0	0	0
t_{fix} FH II-SK + FH II-SK R ²⁾	min	5	6	6	8	3)		
Length of screw / bolt	$L_s, L_h, L_b (- t_{fix})$	≥ 49	≥ 74	≥ 89	≥ 99	≥ 124	≥ 149	≥ 174
Length of countersunk screw	$L_{sk} (- t_{fix})$	≥ 54	≥ 79	≥ 95	≥ 107	3)		

¹⁾ Internal hexagon

²⁾ The influence of the thickness of fixture to the characteristic resistance for shear loads, steel failure without lever arm is taken into account, see tables C3.1, C8.1 and C9.1

³⁾ Anchor type not part of assessment

(Fig. not to scale)

fischer High-Performance Anchor FH II, FH II-I

Product description

Anchor types and dimensions FH II, FH II R

Annex A 2

Table A3.1: Material FH II and FH II R

No.	Designation	Material	
		FH II	FH II R
	Steel grade	Steel	Stainless steel R
		Zinc plated $\geq 5 \mu\text{m}$, ISO 4042:2018	Acc. to EN 10088:2014
1	Hexagon screw	Steel class 8.8; EN ISO 898-1:2013	Class 80 EN ISO 3506:2020
2	Countersunk screw		
3	Cap nut		
4	Hexagon nut		
5	Threaded rod	Steel $f_{uk} \geq 800 \text{ N/mm}^2$; $f_{yk} \geq 640 \text{ N/mm}^2$	Stainless steel EN 10088:2014 $f_{uk} \geq 800 \text{ N/mm}^2$; $f_{yk} \geq 640 \text{ N/mm}^2$
6	Cone nut	Steel EN 10277:2018	Stainless steel EN 10088:2014
7	Distance sleeve	Steel EN 10305:2016	
8	Expansion sleeve	Steel EN 10139:2020/ EN 10277:2018	
9	Plastic sleeve	ABS (plastic)	
10	Washer	Steel EN 10139:2020	Stainless steel EN 10088:2014
11	Conical washer	Steel EN 10277:2018	

fischer High-Performance Anchor FH II, FH II-I

Product description
Materials FH II and FH II R

Annex A 3

Appendix 4/ 22

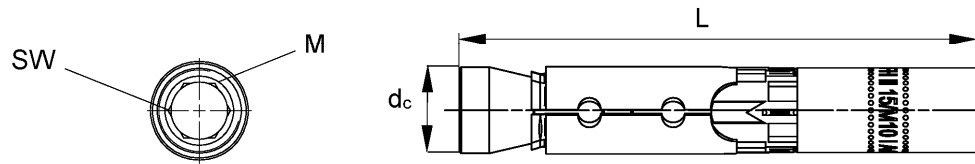

Table A4.1: Anchor Dimensions [mm] FH II-I and FH II-I R

Anchor type FH II-I, FH II-I R		FH II 12/M6 I	FH II 12/M8 I	FH II 15/M10 I	FH II 15/M12 I
Thread	M	6	8	10	12
Diameter cone nut	d _c	12	12	14,8	14,8
Wrench size internal hexagon	SW	6	8	6	8
Anchor length	L	77,5	77,5	90	90

Table A4.2: Material FH II-I and FH II-I R

No.	Designation	Material	
		FH II-I	FH II-I R
	Steel grade	Steel	Stainless steel R
		Zinc plated $\geq 5 \mu\text{m}$, ISO 4042:2018	Acc. to EN 10088:2014
6	Cone nut	Steel EN 10277:2018	Stainless steel EN 10088:2014
8	Expansion sleeve	Steel EN 10139:2020 / EN 10277:2018	
9	Plastic sleeve	ABS (plastic)	
12	Internal thread bolt	Steel EN 10277:2018 $f_{uk} \geq 750 \text{ N/mm}^2$, $f_{yk} \geq 600 \text{ N/mm}^2$	Stainless steel EN 10088:2014 $f_{uk} \geq 750 \text{ N/mm}^2$, $f_{yk} \geq 600 \text{ N/mm}^2$
Requirements for fixing elements		Steel strength class 5.8, 6.8 or 8.8 EN ISO 898-1:2013	Steel strength class A50, A70 or A80 EN ISO 3506:2010 1.4362, 1.4401, 1.4404, 1.4571, 1.4529

(Fig. not to scale)

fischer High-Performance Anchor FH II, FH II-I

Product description



Anchor types, dimensions and materials FH II-I, FH II I-R

Annex A 4

Appendix 5/ 22

Specifications of intended use

Anchorage subject to:

Size		10	12	15	18	24	28	32
High Performance Anchor	FH II-S, -B				✓			
	FH II-H, -S R, -B R, -H R			✓				1)
	FH II-SK, FH II-SK R		✓					1)
High Performance Anchor FH II-I, FH II-I R		1)	✓					1)
Hammer drilling with standard drill bit								
Hammer drilling with hollow drill bit with automatic cleaning					✓			
Static and quasi-static loads								
Cracked and uncracked concrete					✓			
Fire exposure								
Seismic performance category	C1 FH II				✓			
	C1 FH II R	2)		✓				1)
	C2 FH II				✓			
	C2 FH II R			✓				1)
	C1 FH II-I, FH II-I R	1)		2)				1)
	C2 FH II-I, FH II-I R							

1) Anchor type not part of the assessment

2) No performance assessed

Base materials:

- Compacted reinforced or unreinforced normal weight concrete without fibres (cracked and uncracked) of strength classes C20/25 to C50/60 according to EN 206:2013+A1:2016

Use conditions (Environmental conditions):

- Structures subject to dry internal conditions (FH II, FH II R, FH II-I, FH II-I R)
- Structures subject to external atmospheric exposure (including industrial and marine environment) and to permanently damp internal conditions, if no particular aggressive conditions exist (FH II R, FH II-I R)

Note: Particular aggressive conditions are e.g. permanent, alternating immersion in seawater or the splash zone of seawater, chloride atmosphere of indoor swimming pools or atmosphere with extreme chemical pollution (e.g. in desulphurization plants or road tunnels where deicing materials are used)

Design:

- Anchorages are to be designed under the responsibility of an engineer experienced in anchorages and concrete work
- Verifiable calculation notes and drawings are to be prepared taking account of the loads to be anchored. The position of the anchor is indicated on the design drawings (e.g. position of the anchor relative to reinforcement or to supports, etc.)
- Design of fastenings according to EN 1992-4:2018 and EOTA Technical Report TR 055, Edition February 2018

fischer High-Performance Anchor FH II, FH II-I

Intended use
Specifications

Annex B 1

Appendix 6/ 22

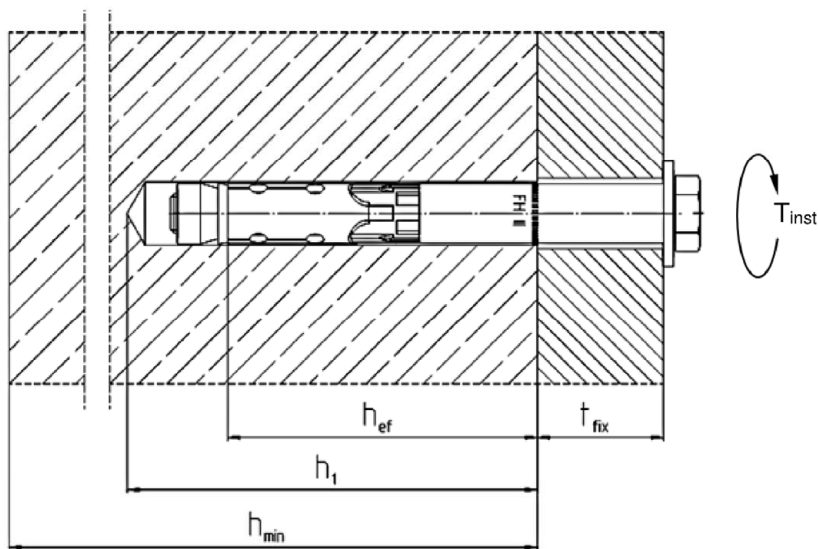

- h_{ef} = Effective embedment depth
 t_{fix} = Thickness of the fixture
 h_1 = Depth of drill hole to deepest point
 h_{min} = Minimum thickness of concrete member
 T_{inst} = Required setting torque

Table B2.1: Installation parameters FH II and FH II R

Anchor type FH II S, -SK, -B, -H and FH II S R, -SK R, -B R, -H R		FH II 10	FH II 12	FH II 15	FH II 18	FH II 24	FH II 28	FH II 32
Nominal drill hole diameter	d_0	10	12	15	18	24	28	32
Maximum diameter of drill bit	$d_{cut} \leq$	10,45	12,50	15,50	18,50	24,55	28,55	32,70
Depth of drill hole to deepest	$h_1 \geq$	55	80	90	105	125	155	180
Diameter of clearance hole	$d_f \leq$	12	14	17	20	26	31	35
Diameter of counter sunk	FH II SK	18	22	25	32	1)		
Depth of counter sunk, 90°	FH II SK R	5,0	5,8	5,8	8,0	1)		
Required setting torque	FH II S	10	22,5	40	80	160	180	200
	FH II B		17,5	38		120	180	200
	FH II H		22,5	40		90	1)	
	FH II SK	1)						
	FH II S R, FH II B R	15	25	40	100	160	1)	
	FH II H R	10				1)		
FH II SK R	1)							

1) Anchor type not part of assessment

(Fig. not to scale)

fischer High-Performance Anchor FH II, FH II-I

Intended use
Installation parameters FH II, FH II R

Annex B 2

Appendix 7/ 22

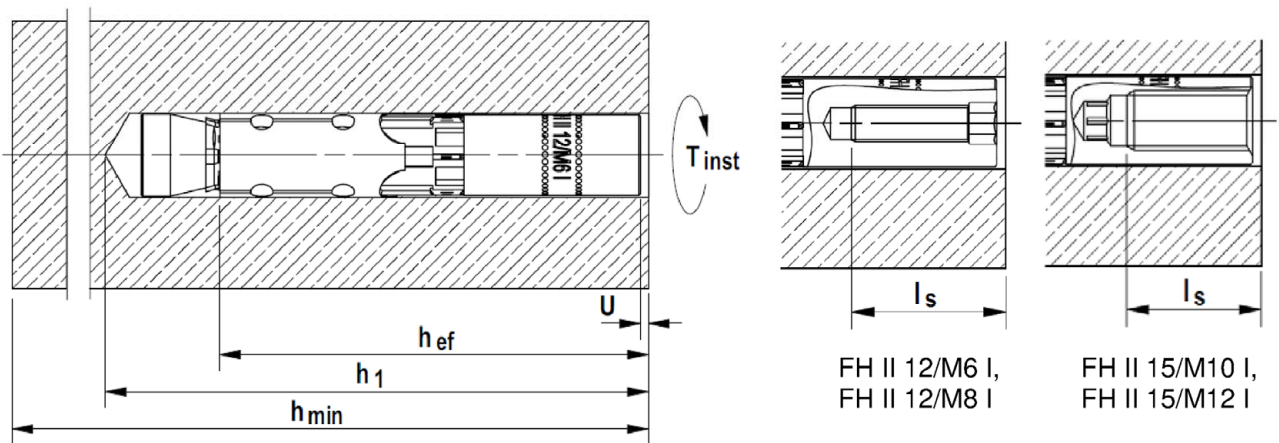

- h_{ef} = Effective embedment depth
- h_1 = Depth of drill hole to deepest point
- h_{min} = Minimum thickness of concrete member
- T_{inst} = Required setting torque
- U = Required gap after torquing
- l_s = Screw-in depth

Table B3.1: Installation parameters FH II-I and FH II-I R

Anchor type FH II-I and FH II-I R		FH II 12/M6 I	FH II 12/M8 I	FH II 15/M10 I	FH II 15/M12 I
Nominal drill hole diameter	d_0	12		15	
Maximum bit diameter	$d_{cut} \leq$	12,50		15,50	
Depth of drill hole	$h_1 \geq$ [mm]	85		95	
Diameter of clearance hole	$d_f \leq$	7	9	12	14
Required gap after torquing ¹⁾	U	3 - 5			
Required setting torque ¹⁾	T_{inst} [Nm]	15		25	
Minimum screw-in depth	$l_s \geq$	$11 + U$	$13 + U$	$10 + U$	$12 + U$
Maximum screw-in depth	$l_s \leq$ [mm]	$20 + U$			
Maximum torque on fixture in combination with screws and threaded rods strength class ≥ 5.8 resp. $\geq A50$	$\max T_{fix}$ [Nm]	3	8	15	20

¹⁾ At least one of the requirements concerning the gap U or the required setting torque T_{inst} have to be fulfilled

(Fig. not to scale)

fischer High-Performance Anchor FH II, FH II-I

Intended use
Installation parameters FH II-I, FH II-I R

Annex B 3

Appendix 8/ 22

Installation instructions:

- Fastener installation carried out by appropriately qualified personnel and under the supervision of the person responsible for technical matters of the site
- Use of the fastener only as supplied by the manufacturer without exchanging the components of the fastener
- Checking before placing the fastener to ensure that the strength class of the concrete in which the fastener is to be placed is in the range given and is not lower than that of the concrete to which the characteristic loads apply
- Check of concrete being well compacted, e.g. without significant voids
- Hammer or hollow drilling according to Annex B5 and B6
- Drill hole created perpendicular $\pm 5^\circ$ to concrete surface, positioning without damaging the reinforcement
- In case of aborted hole: new drilling at a minimum distance twice the depth of the aborted drill hole or smaller distance if the aborted drill hole is filled with high strength mortar and if under shear or oblique tension load it is not in the direction of load application

fischer High-Performance Anchor FH II, FH II-I

Intended Use
Installation instructions

Annex B 4

Appendix 9/ 22

Installation instruction for the fischer High-Performance anchor FH II 10 - FH II 32 and FH II 10 R - FH II 24 R

**Hollow
drilling**

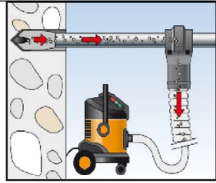

Continue with step 3, 4 and 5

**Hammer
drilling**

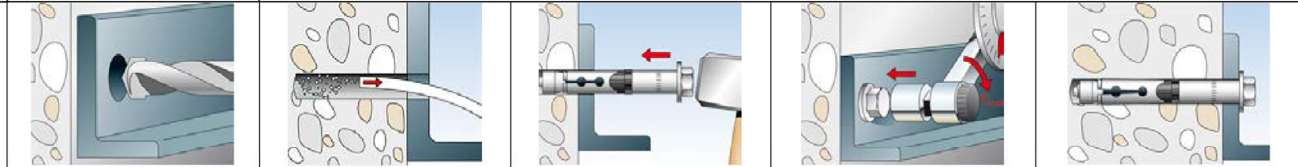

Installation instruction FH II 10 - 32 S and FH II 10 - 24 S R

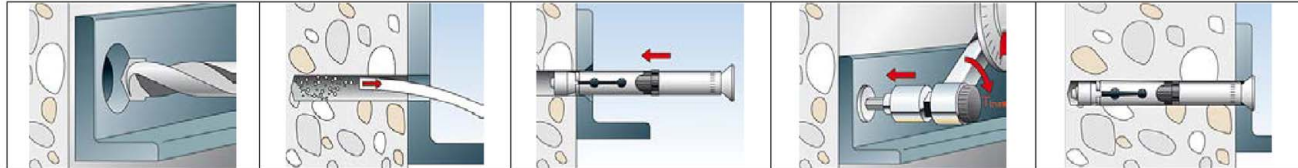

Installation instruction FH II 10 - 18 SK and FH II 10 - 18 SK R

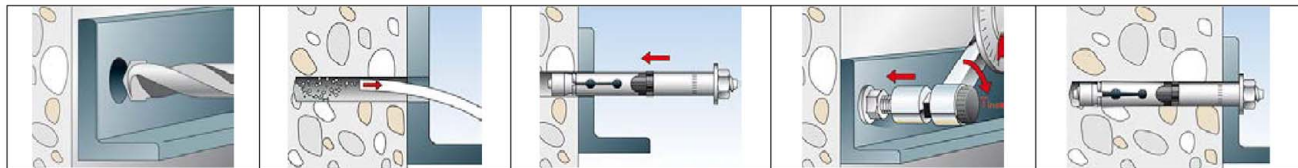

Installation instruction FH II 10 - 32 B and FH II 10 - 24 B R

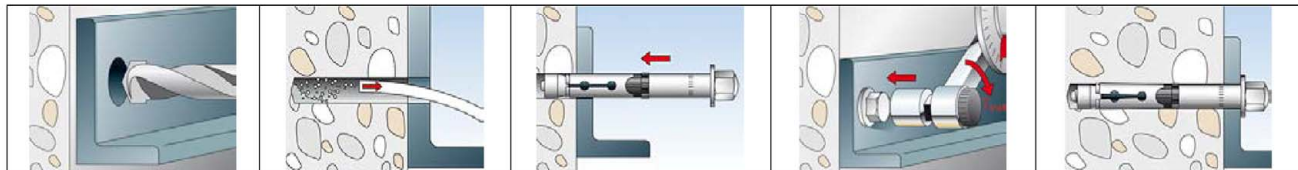

Installation instruction FH II 10 - 24 H and FH II 10 - 24 H R

Step	1	2	3	4	5
------	---	---	---	---	---

Step	Description	
1	Create drill hole with hammer drill	Create drill hole with hollow drill and vacuum cleaner
2	Clean the hole	-
3	Set the fastener	
4	Apply T_{inst}	
5	Installed fastener	

Types of drill bits

Hammer drill



Hollow drill





fischer High-Performance Anchor FH II, FH II-I

Intended use
Installation instructions FH II, FH II R

Annex B 5

Appendix 10/ 22

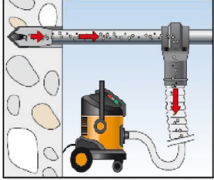
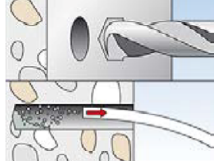
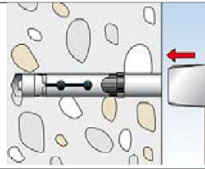
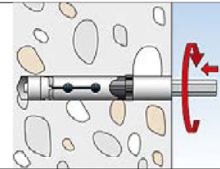
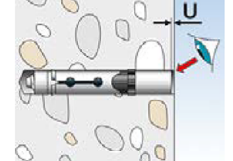
Installation instruction for the fischer High-Performance anchor internal thread
FH II-I and FH II-I R

Hollow drilling		Continue with step 2, 3, and 4			
Hammer drilling					
Step	1	2	3	4	

Step	Description	
1	Create drill hole with hammer drill, clean drill hole	Create drill hole with hollow drill and vacuum cleaner
2	Hammering in the anchor flushed with the surface of the concrete	
3	Tighten the anchor. The included hexagon bit in the package should be used. Other tightening methods are allowed. Tighten the anchor in the concrete until the gap U is 3 - 5 mm or the required setting torque T_{inst} is reached. Only one of the above requirements has to be fulfilled.	
4	Attach the fixture and use a suitable screw or anchor rod. The length of the screw or anchor rod should be determined depending on the thickness of fixture t_{fix} , admissible tolerances, and available thread length $l_{s,max}$ and $l_{s,min}$ including the gap U. Tighten the screw with the torque $\leq \max T_{fix}$ ($\max T_{fix}$ see table B3.1)	

Types of drill bits

Hammer drill



Hollow drill



fischer High-Performance Anchor FH II, FH II-I

Intended use

Installation instructions FH II-I, FH II-I R

Annex B 6

Appendix 11/ 22

Table C1.1: Performance characteristics of tension resistance under static and quasi-static loads for FH II and FH II R

Anchor type FH II-S, -SK, -B, -H and FH II-S R, -SK R, -B R, -H R		FH II 10	FH II 12	FH II 15	FH II 18	FH II 24	FH II 28	FH II 32		
Steel failure										
FH II-S, -B,		16,1	29,3	46,4	67,4	125,3	195,8	282,0		
FH II-H, FH II-H R, -B R		$N_{Rk,s}$	[kN]	16,1	29,3	46,4	67,4	125,3 ²⁾		
FH II-SK		16,1	29,3	46,4	67,4	2)				
Partial factor		γ_{Ms} ¹⁾	[-]	1,5						
FH II-S R		$N_{Rk,s}$	[kN]	16,1	29,3	46,4	67,4	125,3 ²⁾		
FH II-SK R		16,1	29,3	46,4	67,4	2)				
Partial factor		γ_{Ms} ¹⁾	[-]	1,6						
Pullout failure										
Characteristic resistance in cracked concrete C20/25 FH II and FH II R		$N_{Rk,p}$	[kN]	7,5	12,0	16,0	25,0	34,4	48,1	63,3
Characteristic resistance in uncracked concrete C20/25 FH II		$N_{Rk,p}$	[kN]	12,5	22,9	28,8	35,2	49,2	68,8	90,4
Characteristic resistance in uncracked concrete C20/25 FH II R				12,5	20,0	28,8	35,2	49,2	2)	
Increasing factors for $N_{Rk,p}$ for cracked and uncracked concrete		ψ_c	C25/30	1,12						
			C30/37	1,22						
			C35/45	1,32						
			C40/50	1,41						
			C45/55	1,50						
			C50/60	1,58						
Installation factor		γ_{inst}	[-]	1,0						
Concrete cone failure and splitting failure										
Effective embedment depth		h_{ef}	[mm]	40	60	70	80	100	125	150
Factor for cracked concrete		$k_{cr,N}$	[-]	7,7 ³⁾						
Factor for uncracked concrete		$k_{ucr,N}$		11,0 ³⁾						
Spacing		$s_{cr,N}$	[mm]	120	180	210	240	300	375	450
Edge distance		$c_{cr,N}$	[mm]	60	90	105	120	150	187,5	225
Spacing (splitting)		$s_{cr,sp}$	[mm]	190	300	320	340	380	480	570
Edge distance (splitting)		$c_{cr,sp}$	[mm]	95	150	160	170	190	240	285
Characteristic resistance (splitting)		$N^0_{Rk,sp}$	[kN]	min $\{N^0_{Rk,c}, N_{Rk,p}\}$ ⁴⁾						
¹⁾ In absence of other national regulations ²⁾ Anchor type no performance assessed ³⁾ Based on concrete strength as cylinder strength ⁴⁾ $N^0_{Rk,c}$ acc. EN 1992-4:2018										

fischer High-Performance Anchor FH II, FH II-I

Performances

Performance characteristics of tension resistance for FH II and FH II R

Annex C 1

Appendix 12/ 22

Table C2.1: Performance characteristics of **tension resistance** under static and quasi-static loads for **FH II-I and FH II-I R**

Anchor type FH II-I and FH II-I R		FH II 12/M6 I	FH II 12/M8 I	FH II 15/M10 I	FH II 15/M12 I
Steel failure					
Anchor in combination with screw / threaded rod of galvanised steel complying with DIN EN ISO 898					
Strength class 5.8		10	19	29	43
Strength class 6.8	$N_{Rk,s}$ [kN]	12	23	35	44
Strength class 8.8		16	27	44	44
Partial factor	$\gamma_{Ms}^{1)}$ [-]	1,5			
Anchor in combination with screw / threaded rod of stainless steel complying with DIN EN ISO 3506					
Screw/thread strength class A50	$N_{Rk,s}$ [kN]	10	19	29	43
Partial factor	$\gamma_{Ms}^{1)}$ [-]	2,86			
Screw/thread strength class A70	$N_{Rk,s}$ [kN]	14	26	41	54
Partial factor	$\gamma_{Ms}^{1)}$ [-]	1,87			
Screw/thread strength class A80	$N_{Rk,s}$ [kN]	16	29	46	46
Partial factor	$\gamma_{Ms}^{1)}$ [-]	1,60			
Pullout failure					
Characteristic resistance in cracked concrete C20/25	$N_{Rk,p}$ [kN]	9,0		12,0	
Characteristic resistance in uncracked concrete C20/25		20,0		28,8	
Increasing factors for $N_{Rk,p}$ for cracked and uncracked concrete	ψ_c	C25/30	1,12		
		C30/37	1,22		
		C35/45	1,32		
		C40/50	1,41		
		C45/55	1,50		
		C50/60	1,58		
Installation factor	γ_{inst} [-]	1,0			
Concrete cone failure and splitting failure					
Effective embedment depth	h_{ef} [mm]	60		70	
Factor for cracked concrete	$k_{cr,N}$ [-]	7,7 ²⁾			
Factor for uncracked concrete	$k_{ucr,N}$ [-]	11,0 ²⁾			
Spacing	$s_{cr,N}$	180		210	
Edge distance	$c_{cr,N}$ [mm]	90		105	
Spacing (splitting)	$s_{cr,sp}$	300		320	
Edge distance (splitting)	$c_{cr,sp}$	150		160	
Characteristic resistance (splitting)	$N^0_{Rk,sp}$ [kN]	$\min \{N^0_{Rk,c}, N_{Rk,p}\}^{3)}$			
¹⁾ In absence of other national regulations ²⁾ Based on concrete strength as cylinder strength ³⁾ $N^0_{Rk,c}$ acc. EN 1992-4:2018					

fischer High-Performance Anchor FH II, FH II-I

Performances

Performance characteristics of tension resistance for FH II-I and FH II-I R

Annex C 2

Appendix 13/ 22

Table C3.1: Performance characteristics of **shear resistance** for **FH II and FH II R** under static and quasi-static loads

Anchor type FH II-S, -SK, -B, -H and FH II-S R, -SK R, -B R, -H R		FH II 10	FH II 12	FH II 15	FH II 18	FH II 24	FH II 28	FH II 32
Installation factor	γ_{inst} [-]	1,0						
Steel failure without lever arm								
FH II-S		18,0	33,0	59,0	76,0	146,0	176,4	217,0
FH II-B	$V_{RK,s}^0$ [kN]	16,0	27,2	42,8	61,9	119,0	148,8	169,0
FH II-H		16,0	27,2	42,8	61,9	119,0	3)	
FH II-SK	$t_{fix}^{2)}$ [mm]	≥ 10		≥ 15		3)		
	$V_{RK,s}^0$ [kN]	18,0	33,0	59,0	76,0			
	$t_{fix}^{2)}$ [mm]	< 10		< 15				
	$V_{RK,s}^0$ [kN]	8,0	14,0	23,0	34,0			
Partial factor	$\gamma_{Ms}^{1)}$ [-]	1,25						
Factor for ductility	k_7	1,0						
FH II-S R	$V_{RK,s}^0$ [kN]	18,0	33,0	59,0	76,0	146,0	3)	
Partial factor	$\gamma_{Ms}^{1)}$ [-]	1,33						
FH II-B R, -H R	$V_{RK,s}^0$ [kN]	16,0	27,2	42,8	61,9	119,0	3)	
Partial factor	$\gamma_{Ms}^{1)}$ [-]	1,25						
FH II-SK R	$t_{fix}^{2)}$ [mm]	≥ 10		≥ 15		3)		
	$V_{RK,s}^0$ [kN]	18,0	33,0	59,0	76,0			
	$t_{fix}^{2)}$ [mm]	< 10		< 15				
	$V_{RK,s}^0$ [kN]	8,0	14,0	23,0	34,0			
Partial factor	$\gamma_{Ms}^{1)}$ [-]	1,33						
Factor for ductility	k_7	1,0						
Steel failure with lever arm and concrete pryout failure								
Characteristic bending resistance FH II-S, -SK, -B, -H	$M_{RK,s}^0$ [Nm]	12	30	60	105	266	518	896
Partial factor	$\gamma_{Ms}^{1)}$ [-]	1,25						
Characteristic bending resistance FH II R	$M_{RK,s}^0$ [Nm]	12	30	60	105	266	3)	
Partial factor	$\gamma_{Ms}^{1)}$ [-]	FH II-B R, -H R		1,25				
		FH II-S R, -SK R		1,33				
Factor for pryout failure	k_8 [-]	1,0	2,0					
Concrete edge failure								
Effective embedment depth for calculation	$l_{r=}$ [mm]	h_{ef}						
Outside diameter of a fastener	d_{nom}	10	12	15	18	24	28	32

¹⁾ In absence of other national regulations

²⁾ The thickness of the fixture has influence to the characteristic resistance for shear loads, steel failure without lever arm

³⁾ No performance assessed

fischer High-Performance Anchor FH II, FH II-I

Performances

Performance characteristics of shear resistance for FH II and FH II R

Annex C 3

Table C4.1: Performance characteristics of **shear resistance** for **FH II-I and FH II-I R** under static and quasi-static loads

Anchor type FH II-I and FH II-I R		FH II 12/M6 I	FH II 12/M8 I	FH II 15/M10 I	FH II 15/M12 I
Installation factor	γ_{inst} [-]	1,0			
Steel failure without lever arm					
Anchor in combination with screw / threaded rod of galvanised steel complying with DIN EN ISO 898:2013					
Strength class 5.8		5	9	15	21
Strength class 6.8	$V^0_{Rk,s}$ [kN]	6	11	18	24
Strength class 8.8		8	14	23	24
Partial factor	$\gamma_{Ms}^{1)}$ [-]	1,25			
Factor for ductility	k_7	1,0			
Anchor in combination with screw / threaded rod of stainless steel complying with DIN EN ISO 3506:2010					
Strength class A50	$V^0_{Rk,s}$ [kN]	5	9	15	21
Partial factor	$\gamma_{Ms}^{1)}$ [-]	2,38			
Strength class A70	$V^0_{Rk,s}$ [kN]	7	13	20	30
Partial factor	$\gamma_{Ms}^{1)}$ [-]	1,56			
Strength class A80	$V^0_{Rk,s}$ [kN]	8	15	23	32
Partial factor	$\gamma_{Ms}^{1)}$ [-]	1,33			
Factor for ductility	k_7	1,0			
Steel failure with lever arm and concrete pryout failure					
Anchor in combination with screw / threaded rod of galvanised steel complying with DIN EN ISO 898:2013					
Strength class 5.8		8	19	37	65
Strength class 6.8	$M^0_{Rk,s}$ [Nm]	9	23	44	78
Strength class 8.8		12	30	60	105
Partial factor	$\gamma_{Ms}^{1)}$ [-]	1,25			
Factor for ductility	k_7	1,0			
Anchor in combination with screw / threaded rod of stainless steel complying with DIN EN ISO 3506:2010					
Strength class A50	$M^0_{Rk,s}$ [Nm]	8	19	37	65
P Partial factor	$\gamma_{Ms}^{1)}$ [-]	2,38			
Strength class A70	$M^0_{Rk,s}$ [Nm]	11	26	52	92
Partial factor	$\gamma_{Ms}^{1)}$ [-]	1,56			
Strength class A80	$M^0_{Rk,s}$ [Nm]	12	30	60	105
Partial factor	$\gamma_{Ms}^{1)}$	1,33			
Factor for ductility	k_7 [-]	1,0			
Factor for pryout failure	k_8	2,0			
Concrete edge failure					
Effective embedment depth for calculation	$l_f =$ [mm]	h_{ef}			
Outside diameter of fastener	d_{nom}	12		15	

¹⁾ In absence of other national regulations

fischer High-Performance Anchor FH II, FH II-I

Performances

Performance characteristics of shear resistance for FH II-I and FH II-I R

Annex C 4

Table C5.1: Performance characteristics of tension resistance under fire exposure

Anchor type	R30			R60		
	$N_{Rk,s,fi,30}$ [kN]	$N_{Rk,p,fi,30}$ [kN]	$N^0_{Rk,c,fi,30}$ [kN]	$N_{Rk,s,fi,60}$ [kN]	$N_{Rk,p,fi,60}$ [kN]	$N^0_{Rk,c,fi,60}$ [kN]
FH II 10, FH II 10 R	0,2	1,8	1,8	0,2	1,8	1,8
FH II 12, FH II 12 R	2,0	3,0	5,0	1,3	3,0	5,0
FH II 15, FH II 15 R	3,2	4,0	7,4	2,3	4,0	7,4
FH II 18, FH II 18 R	4,8	6,3	10,3	3,9	6,3	10,3
FH II 24, FH II 24 R	8,9	9,0	18,0	7,3	9,0	18,0
FH II 28	13,9	12,6	31,4	11,3	12,6	31,4
FH II 32	20,0	16,5	49,6	16,3	16,5	49,6
FH II 12/M6-I, 5.8, A50 ¹⁾	0,1	2,3	5,0	0,1	2,3	5,0
FH II 12/M6-I R 8.8, A70, A80 ^{1) 2)}	0,2			0,2		
FH II 12/M8-I, 5.8, A50 ¹⁾	1,3			0,8		
FH II 12/M8-I R 8.8, A70, A80 ^{1) 2)}	2,0			1,3		
FH II 15/M10-I, 5.8, A50 ¹⁾	2,0	3,0	7,4	1,4	3,0	7,4
FH II 15/M10-I R 8.8, A70, A80 ^{1) 2)}	3,2			2,3		
FH II 15/M12-I, 5.8/A50 ¹⁾	3,0			2,4		
FH II 15/M12-I R 8.8, A70, A80 ^{1) 2)}	4,8			3,9		
Anchor type	R90			R120		
	$N_{Rk,s,fi,90}$ [kN]	$N_{Rk,p,fi,90}$ [kN]	$N^0_{Rk,c,fi,90}$ [kN]	$N_{Rk,s,fi,120}$ [kN]	$N_{Rk,p,fi,120}$ [kN]	$N^0_{Rk,c,fi,120}$ [kN]
FH II 10, FH II 10 R	0,1	1,8	1,8	0,1	1,5	1,5
FH II 12, FH II 12 R	0,6	3,0	5,0	0,2	2,4	4,0
FH II 15, FH II 15 R	1,4	4,0	7,4	1,0	3,2	5,9
FH II 18, FH II 18 R	3,0	6,3	10,3	2,6	5,0	8,2
FH II 24, FH II 24 R	5,6	9,0	18,0	4,8	7,2	14,4
FH II 28	8,8	12,6	31,4	7,5	10,1	25,2
FH II 32	12,6	16,5	49,6	10,8	13,2	39,7
FH II 12/M6-I, 5.8, A50 ¹⁾	0,1	2,3	5,0	0,1	1,8	4,0
FH II 12/M6-I R 8.8, A70, A80 ^{1) 2)}	0,1			0,1		
FH II 12/M8-I, 5.8, A50 ¹⁾	0,4			0,1		
FH II 12/M8-I R 8.8, A70, A80 ^{1) 2)}	0,6			0,2		
FH II 15/M10-I, 5.8, A50 ¹⁾	0,9	3,0	7,4	0,6	2,4	5,9
FH II 15/M10-I R 8.8, A70, A80 ^{1) 2)}	1,4			1,0		
FH II 15/M12-I, 5.8/A50 ¹⁾	1,9			1,6		
FH II 15/M12-I R 8.8, A70, A80 ^{1) 2)}	3,0			2,6		

¹⁾ Intermediate values by linear interpolation

²⁾ In combination with screw / threaded rod strength class 8.8, A70, A80

fischer High-Performance Anchor FH II, FH II-I

Performances

Performance characteristics of tension resistance under fire exposure

Annex C 5

Appendix 16/ 22

Table C6.1: Performance characteristics of shear resistance under fire exposure

Anchor type	R30		R60	
	$V_{Rk,s,fi,30}$ [kN]	$M^0_{Rk,s,fi,30}$ [Nm]	$V_{Rk,s,fi,60}$ [kN]	$M^0_{Rk,s,fi,60}$ [Nm]
FH II 10, FH II 10 R	0,3	0	0,3	0
FH II 12, FH II 12 R	2,0	2	1,3	1
FH II 15, FH II 15 R	3,2	4	2,3	3
FH II 18, FH II 18 R	4,8	7	3,9	6
FH II 24, FH II 24 R	8,9	19	7,3	15
FH II 28	13,9	37	11,3	30
FH II 32	20,0	64	16,3	52
FH II 12/M6 I, 5.8, A50 ¹⁾	0,2	0	0,2	0
FH II 12/M6 I R 8.8, A70, A80 ^{1) 2)}	0,3	0	0,3	0
FH II 12/M8 I, 5.8, A50 ¹⁾	1,3	1	0,8	1
FH II 12/M8-I R 8.8, A70, A80 ^{1) 2)}	2,0	2	1,3	1
FH II 15/M10 I, 5.8, A50 ¹⁾	2,0	3	1,4	2
FH II 15/M10-I R 8.8, A70, A80 ^{1) 2)}	3,2	4	2,3	3
FH II 15/M12-I, 5.8/A50 ¹⁾	3,0	4	2,4	4
FH II 15/M12-I R 8.8, A70, A80 ^{1) 2)}	4,8	7	3,9	6

Anchor type	R90		R120	
	$V_{Rk,s,fi,90}$ [kN]	$M^0_{Rk,s,fi,90}$ [Nm]	$V_{Rk,s,fi,120}$ [kN]	$M^0_{Rk,s,fi,120}$ [Nm]
FH II 10, FH II 10 R	0,2	0	0,1	0
FH II 12, FH II 12 R	0,6	1	0,2	0
FH II 15, FH II 15 R	1,4	2	1,0	1
FH II 18, FH II 18 R	3,0	5	2,6	4
FH II 24, FH II 24 R	5,6	12	4,8	10
FH II 28	8,8	23	7,5	20
FH II 32	12,6	40	10,8	34
FH II 12/M6-I, 5.8, A50 ¹⁾	0,1	0	0,1	0
FH II 12/M6-I R 8.8, A70, A80 ^{1) 2)}	0,2	0	0,1	0
FH II 12/M8-I, 5.8, A50 ¹⁾	0,4	1	0,1	0
FH II 12/M8-I R 8.8, A70, A80 ^{1) 2)}	0,6	1	0,2	0
FH II 15/M10 I, 5.8, A50 ¹⁾	0,9	2	0,6	1
FH II 15/M10-I R 8.8, A70, A80 ^{1) 2)}	1,4	3	1,0	1
FH II 15/M12 I, 5.8/A50 ¹⁾	1,9	4	1,6	3
FH II 15/M12-I R 8.8, A70, A80 ^{1) 2)}	3,0	6	2,6	4

¹⁾ Intermediate values by linear interpolation

²⁾ In combination with screw / threaded rod strength class 8.8, A70, A80

Table C6.2: Minimum spacings and minimum edge distances of anchors under fire exposure for tension and shear loads

Anchor type	FH II 10	FH II 12 FH II 12-I	FH II 15 FH II 15-I	FH II 18	FH II 24	FH II 28	FH II 32
Spacing $\frac{S_{cr,N,fi}}{S_{min,fi}}$	4x h _{ef}						
	40	50	60	70	80	100	120
Edge distance $\frac{C_{cr,N,fi}}{C_{min,fi}}$ [mm]	2 x h _{ef}						
	C _{min,fi} = 2 x h _{ef} , for fire exposure from more than one side C _{min,fi} ≥ 300 mm						

fischer High-Performance Anchor FH II, FH II-I

Performances

Performance characteristics of shear resistance under fire exposure

Minimum spacings and minimum edge distances of anchors under fire exposure

Annex C 6

Table C7.1: Minimum thickness of concrete member, minimum spacing and minimum edge distances
FH II, FH II R

Anchor type FH II-S, -SK, -B, -H and FH II-S R, -SK R, -B R, -H R		FH II 10	FH II 12	FH II 15	FH II 18	FH II 24	FH II 28	FH II 32
Minimum thickness of concrete member	h_{min} [mm]	80	120	140	160	200	250	300
Minimum spacing, cracked concrete	s_{min}	40	50	60	70	80	100	120
	for $c \geq$ [mm]	40	80	120	140	180	200	260
Minimum edge distance, cracked concrete	c_{min}	40	50	60	70	80	100	120
	for $s \geq$	40	80	120	160	200	220	280
Minimum spacing, uncracked concrete	s_{min}	40	60	70	80	100	120	160
	for $c \geq$ [mm]	70	100	100	160	200	220	360
Minimum edge distance, uncracked concrete	c_{min}	40	60	70	80	100	120	180
	for $s \geq$	70	100	140	200	220	240	380

Intermediate values may be calculated by linear interpolation

Table C7.2: Minimum thickness of concrete member, minimum spacing and minimum edge distances
FH II-I, FH II-I R

Anchor type FH II-I and FH II-I R		FH II 12/M6 I FH II 12/M8 I	FH II 15/M10 I FH II 15/M12 I
Minimum thickness of concrete member	h_{min} [mm]	125	150
Minimum spacing, cracked concrete	s_{min}	50	60
	for $c \geq$ [mm]	80	120
Minimum edge distance, cracked concrete	c_{min}	50	60
	for $s \geq$	80	120
Minimum spacing, uncracked concrete	s_{min}	60	70
	for $c \geq$ [mm]	100	100
Minimum edge distance, uncracked concrete	c_{min}	60	70
	for $s \geq$	100	140

Intermediate values may be calculated by linear interpolation.

fischer High-Performance Anchor FH II, FH II-I

Performances

Minimum thickness of concrete member, minimum spacing and minimum edge distances

Annex C 7

Table C8.1: Performance characteristics of tension and shear resistance for seismic performance category C1 for FH II-S, -SK, -B, -H and FH II-S R, -SK R, -B R, -H R

Anchor type FH II-S, -SK, -B, -H and FH II-S R, -SK R, -B R, -H R		FH II 12	FH II 15	FH II 18	FH II 24	FH II 28	FH II 32		
Steel failure									
Characteristic resistance of tension load C1	FH II-S, -B		29,3	46,4	67,4	125,3	195,8	282,0	
	FH II-H, -H R, -B R	$N_{Rk,s,C1}$ [kN]	29,3	46,4	67,4	125,3	3)		
	FH II-SK		29,3	46,4	67,4	3)			
	Partial factor	$\gamma_{Ms,C1}^{1)}$ [-]	1,5						
	FH II-S R	$N_{Rk,s,C1}$ [kN]	29,3	46,4	67,4	125,3	3)		
	FH II-SK R		29,3	46,4	67,4	3)			
	Partial factor	$\gamma_{Ms,C1}^{1)}$ [-]	1,6						
Pullout failure									
Characteristic resistance of tension load in cracked concrete C1		$N_{Rk,p,C1}$ [kN]	12,0	16,0	25,0	36,0	50,3	66,1	
		$\gamma_{Mp,C1}^{1)}$ [-]	1,5						
Steel failure without lever arm									
Characteristic resistance of shear load C1									
FH II-S			25,0	41,0	60,0	123,0	141,0	200,0	
FH II-B	$V_{Rk,s,C1}$ [kN]		17,0	30,0	46,0	103,0	117,0	169,0	
FH II-H			17,0	30,0	46,0	103,0			
FH II-SK	$t_{fix}^{2)}$ [mm]		≥ 10	≥ 15		3)			
	$V_{Rk,s,C}$ [kN]		25,0	41,0	60,0				
	$t_{fix}^{2)}$ [mm]		< 10	< 15					
	$V_{Rk,s,C}$ [kN]		11,0	16,0	27,0				
Partial factor	$\gamma_{Ms,C1}^{1)}$ [-]	1,25							
FH II-S R	$V_{Rk,s,C1}$ [kN]		25,0	41,0	60,0	123,0	-		
Partial factor	$\gamma_{Ms,C1}^{1)}$ [-]	1,33							
FH II-B R, -H R	$V_{Rk,s,C1}$ [kN]		17,0	30,0	46,0	103,0	-		
Partial factor	$\gamma_{Ms,C1}^{1)}$ [-]	1,25							
FH II-SK R	$t_{fix}^{2)}$ [mm]		≥ 10	≥ 15		3)			
	$V_{Rk,s,C1}$ [kN]		25,0	41,0	60,0				
	$t_{fix}^{2)}$ [mm]		< 10	< 15					
	$V_{Rk,s,C1}$ [kN]		11,0	16,0	27,0				
Partial factor	$\gamma_{Ms,C1}^{1)}$ [-]	1,33							
Factor for annular gap	α_{gap}	0,50							

1) In absence of other national regulations

2) The thickness of the fixture has influence to the characteristic resistance for shear loads, steel failure without lever arm

3) No performance assessed

fischer High-Performance Anchor FH II, FH II-I

Performances

Performance characteristics of tension and shear resistance for seismic performance category C1

Annex C 8

Appendix 19/ 22

Table C9.1: Performance characteristics of tension and shear resistance for seismic performance category C2 for FH II-S, -SK, -B, -H and FH II-S R, -SK R, -B R, -H R

Anchor type FH II-S, -SK, -B, -H and FH II-S R, -SK R, -B R, -H R				FH II 12	FH II 15	FH II 18	FH II 24	FH II 28	FH II 32
Steel failure									
Characteristic resistance of tension load C2	FH II-S, -B			29,3	46,4	67,4	125,3	195,8	
	FH II-H, -H R, -B R	$N_{Rk,s,C2}$	[kN]	29,3	46,4	67,4	125,3	3)	
	FH II-SK			29,3	46,4	67,4	3)		
	Partial factor	$\gamma_{Ms,C2}^{1)}$	[-]	1,5					
	FH II-S R			29,3	46,4	67,4	125,3	3)	
	FH II-SK R	$N_{Rk,s,C2}$	[kN]	29,3	46,4	67,4	3)		
	Partial factor	$\gamma_{Ms,C2}^{1)}$	[-]	1,6					
Pullout failure									
Characteristic resistance of tension load in cracked concrete C2		$N_{Rk,p,C2}$	[kN]	6,2	11,3	21,8	43,0	65,9	
		$\gamma_{Mp,C2}^{1)}$	[-]	1,5					
Steel failure without lever arm									
Characteristic resistance of shear load C2									
FH II-S				14,7	28,9	41,0	100,7		
FH II-B	$V_{Rk,s,C2}$	[kN]		9,8	20,9	34,1	61,9	67,2	
FH II-H				9,8	20,9	34,1	61,9	3)	
FH II-SK	$t_{fix}^{2)}$	[mm]		≥ 10	≥ 15		3)		
	$V_{Rk,s,C2}$	[kN]		14,8	23,3	33,8			
	$t_{fix}^{2)}$	[mm]		< 10	< 15				
	$V_{Rk,s,C2}$	[kN]		6,3	9,1	15,1			
Partial factor	$\gamma_{Ms,C2}^{1)}$	[-]	1,25						
FH II-S R	$V_{Rk,s,C2}$	[kN]		14,7	28,9	41,0	100,7	3)	
Partial factor	$\gamma_{Ms,C2}^{1)}$	[-]	1,33						
FH II-B R, -H R	$V_{Rk,s,C2}$	[kN]		9,8	20,9	34,1	61,9	3)	
Partial factor	$\gamma_{Ms,C2}^{1)}$	[-]	1,25						
FH II-SK R	$t_{fix}^{2)}$	[mm]		≥ 10	≥ 15		3)		
	$V_{Rk,s,C2}$	[kN]		14,8	23,3	33,8			
	$t_{fix}^{2)}$	[mm]		< 10	< 15				
	$V_{Rk,s,C2}$	[kN]		6,3	9,1	15,1			
Partial factor	$\gamma_{Ms,C2}^{1)}$	[-]	1,33						
Factor for annular gap	α_{gap}	[-]	0,50						

1) In absence of other national regulations

2) The thickness of the fixture has influence to the characteristic resistance for shear loads, steel failure without lever arm

3) No performance assessed

fischer High-Performance Anchor FH II, FH II-I

Performances

Performance characteristics of tension and shear resistance for seismic performance category C2

Annex C 9

Appendix 20/ 22

Table C10.1: Displacements under static and quasi static **tension loads** for FH II and FH II R

Anchor type FH II-S, -SK, -B, -H and FH II-S R, -SK R, -B R, -H R		FH II 10	FH II 12	FH II 15	FH II 18	FH II 24	FH II 28	FH II 32
Tension load cracked concrete	N [kN]	3,6	5,7	7,6	11,9	17,1	24,0	31,5
Corresponding displacements	$\frac{\delta_{N0}}{\delta_{N\infty}}$ [mm]	1,0	1,0	1,0	1,0	1,0	0,7	0,7
		1,7	1,6	1,6	1,6	1,8	1,3	1,1
Tension load uncracked concrete	N [kN]	6,0	11,2	14,1	17,2	24,0	33,6	44,2
Corresponding displacements	$\frac{\delta_{N0}}{\delta_{N\infty}}$ [mm]	0,6	1,0	1,0	1,0	1,0	0,3	0,3
		1,7	1,6	1,6	1,6	1,8	1,3	1,1

Table C10.2: Displacements under static and quasi static **tension loads** for FH II-I and FH II-I R

Anchor type FH II-I and FH II-I R		FH II 12/M6 I FH II 12/M8 I	FH II 15/M10 I FH II 15/M12 I
Tension load cracked concrete	N [kN]	4,3	5,7
Tension load uncracked concrete		9,5	14,1
Corresponding displacements	$\frac{\delta_{N0}}{\delta_{N\infty}}$ [mm]	1,7	1,9
		2,2	2,9

Table C10.3: Displacements under static and quasi static **shear loads** for FH II-S and FH II-SK

Anchor type FH II-S and FH II-SK		FH II 10	FH II 12	FH II 15	FH II 18	FH II 24	FH II 28	FH II 32
Shear load in cracked and uncracked concrete	V [kN]	10,3	18,9	33,7	43,4	83,4	99,4	124,0
Corresponding displacements	$\frac{\delta_{V0}}{\delta_{V\infty}}$ [mm]	2,4	2,7	4,4	5,0	7,0	6,0	8,0
		3,6	4,1	6,6	7,5	10,5	9,0	12,0

Table C10.4: Displacements under static and quasi static **shear loads** for FH II-B and FH II-H

Anchor type FH II-B and FH II-H		FH II 10	FH II 12	FH II 15	FH II 18	FH II 24	FH II 28	FH II 32
Shear load in cracked and uncracked concrete	V [kN]	8,9	15,4	23,4	35,4	68,0	83,4	96,6
Corresponding displacements	$\frac{\delta_{V0}}{\delta_{V\infty}}$ [mm]	2,2	2,3	3,0	5,0	7,0	5,0	5,0
		3,3	3,5	4,5	7,5	10,5	7,5	7,5

fischer High-Performance Anchor FH II, FH II-I

Performances
Displacements under tension and shear loads

Annex C 10

Appendix 21/ 22

Table C11.1: Displacements under static and quasi static **shear loads** for FH II-S R, FH II-SK R, FH II-B R and FH II-H R

Anchor type FH II-S R, -SK R, -B R, -H R		FH II 10	FH II 12	FH II 15	FH II 18	FH II 24
Shear load in cracked and uncracked concrete	V [kN]	10,3	16,0	24,6	37,7	68,0
Corresponding displacements	$\frac{\delta_{V0}}{\delta_{V\infty}}$ [mm]	3,5	3,5	3,7	5,7	9,0
		5,3	5,3	5,6	8,6	13,5

Table C11.2: Displacements under static and quasi static **shear loads** for FH II-I and FH II-I R

Anchor type: FH II-I and FH II-I R		FH II 12/M6 I	FH II 12/M8 I	FH II 15/M10 I	FH II 15/M12 I
Shear load in cracked and uncracked concrete	V [kN]	4,6	8,3	13,3	13,7
Corresponding displacements	$\frac{\delta_{V0}}{\delta_{V\infty}}$ [mm]	2,6	2,6	2,2	2,2
		3,9	3,9	3,3	3,3

Table C11.3: Displacements under **tension loads** for **seismic performance category C2** for FH II and FH II R

Anchor type FH II-S, -SK, -B, -H and FH II-S R, -SK R, -B R, -H R		FH II 12	FH II 15	FH II 18	FH II 24	FH II 28	FH II 32
Displacement DLS $\delta_{N,C2 (DLS)}$	[mm]	1,55	2,63	2,04	4,26	3,06	
Displacement ULS $\delta_{N,C2 (ULS)}$		8,71	11,07	7,30	11,70	11,44	

Table C11.4: Displacements under **shear loads** for **seismic performance category C2** for FH II and FH II R

Anchor type FH II-S, -SK and FH II-S R, -SK R		FH II 12	FH II 15	FH II 18	FH II 24	FH II 28	FH II 32
Displacement DLS $\delta_{V,C2 (DLS)}$	[mm]	3,53	4,18	4,67	5,59	4,79	
Displacement ULS $\delta_{V,C2 (ULS)}$		6,62	7,38	9,03	14,09	9,95	

Anchor type FH II-B, -H and FH II-B R, -H R		FH II 12	FH II 15	FH II 18	FH II 24	FH II 28	FH II 32
Displacement DLS $\delta_{V,C2 (DLS)}$	[mm]	3,42	4,26	4,29	4,79		
Displacement ULS $\delta_{V,C2 (ULS)}$		5,26	6,66	7,95	7,69	9,95	

fischer High-Performance Anchor FH II, FH II-I

Performances
Displacements under tension and shear loads

Annex C 11

Appendix 22/ 22