

PROHLÁŠENÍ O VLASTNOSTECH

DoP 0269

pro stropní hřeb fischer FDZ (mechanický kotevní prvek pro použití v betonu)

CS

1. Jedinečný identifikační kód typu výrobku: DoP 0269
2. Zamýšlené/zamýšlená použití: Dodatečně instalovaný upevňovací prvek pro použití v betonu pro nekonstrukční systémy, viz. dodatek, obzvláště Přílohy B1 - B2.
3. Výrobce: fischerwerke GmbH & Co. KG, Klaus-Fischer-Str. 1, 72178 Waldachtal, Německo
4. Zplnomocněný zástupce: -
5. Systém/systémy POSV: 2+
6. Evropský dokument pro posuzování: ETAG 001, Part 6, April 2013, použito jako EAD
Evropské technické posouzení: ETA-17/0737; 2018-01-30
Subjekt pro technické posuzování: DIBt- Deutsches Institut für Bautechnik
Oznámený subjekt/oznámené subjekty: 2873 TU Darmstadt
7. Deklarovaná vlastnost/Deklarované vlastnosti:
Bezpečnost při používání (BWR 4)
Charakteristická únosnost v tahu (pro statickou a kvazistatickou akci):
Odolnost proti selhání oceli: NPD
Odolnost proti selhání vytažením: NPD
Odolnost proti selhání betonu: NPD
Pevnost: Příloze C1
Minimální vzdálenost od okraje a rozteč: Přílohy B2, C1
Okrajová vzdálenost bránící rozštěpení při zatížení: NPD

Charakteristická únosnost ve smyku (pro statickou a kvazistatickou akci):
Odolnost proti selhání oceli (smykové zatížení): Příloze C1 $V_{Rk,s}=NPD; k_{\gamma}=NPD$
Odolnost proti selhání rozštěpením: NPD
Odolnost proti selhání okraje betonu: NPD

Charakteristická únosnost pro všechny směry zatížení a způsoby porušení pro zjednodušený návrh:
Charakteristická únosnost: Příloze C1

Životnost:
Životnost: Příloze B1

Bezpečnost v případě požáru (BWR 2)
Reakce na oheň: Třída (A1)
Odolnost proti požáru:
Požární odolnost proti selhání oceli (tahové zatížení): NPD
Požární odolnost proti selhání vytažením (tahové zatížení): NPD
Požární odolnost proti selhání oceli (smykové zatížení): NPD
Požární odolnost pro všechny směry zatížení a způsoby poruch: Příloze C1
8. Příslušná technická dokumentace a/nebo specifická technická dokumentace: -

Vlastnosti výše uvedeného výrobku jsou ve shodě se souborem deklarovaných vlastností. Toto prohlášení o vlastnostech se v souladu s nařízením (EU) č. 305/2011 vydává na výhradní odpovědnost výrobce uvedeného výše.

Podepsáno za výrobce a jeho jménem:



Dr.-Ing. Oliver Geibig, Výkonný ředitel pro obchodní jednotky a inženýrství
Tumlingen, 2021-01-11



Jürgen Grün, Výkonný ředitel pro chemii a kvalitu

Toto PoV bylo připraveno v různých jazykových mutacích. V případě rozporu vždy rozhoduje interpretace verze v anglickém jazyce.

Příloha obsahuje nepovinné a doplňkové informace v anglickém jazyce nad rámec zákonných požadavků.

Specific Part

1 Technical description of the product

The fischer Ceiling Anchor FDZ is an anchor made of galvanized steel which is placed into a drilled hole and anchored by deformation-controlled expansion.

The product description is given in Annex A.

2 Specification of the intended use in accordance with the applicable European Assessment Document

The performances given in Section 3 are only valid if the anchor is used in compliance with the specifications and conditions given in Annex B.

The verifications and assessment methods on which this European Technical Assessment is based lead to the assumption of a working life of the anchor of at least 50 years. The indications given on the working life cannot be interpreted as a guarantee given by the producer, but are to be regarded only as a means for choosing the right products in relation to the expected economically reasonable working life of the works.

3 Performance of the product and references to the methods used for its assessment

3.1 Mechanical resistance and stability (BWR 1)

The essential characteristics regarding mechanical resistance and stability are included under the Basic Works Requirement Safety in use.

3.2 Safety in case of fire (BWR 2)

Essential characteristic	Performance
Reaction to fire	Anchorage satisfy requirements for Class A1
Resistance to fire	See Annex C 1

3.3 Safety in use (BWR 4)

Essential characteristic	Performance
Characteristic resistance in concrete	See Annex C 1

4 Assessment and verification of constancy of performance (AVCP) system applied, with reference to its legal base

In accordance with guideline for European technical approval ETAG 001, April 2013 used as European Assessment Document (EAD) according to Article 66 Paragraph 3 of Regulation (EU) No 305/2011 the applicable European legal act is: [97/161/EC].

The system to be applied is: 2+

Product installation conditions, product marking and product dimensions

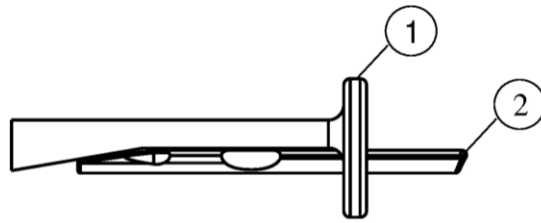

- ① Shaft
- ② Pin

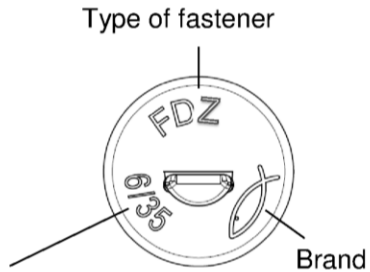
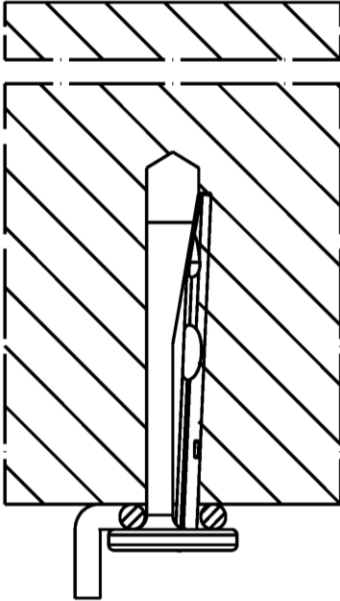

Nominal diameter / max. thickness of the fixture;
Additional marking "K" for $h_{ef} = 25$ mm

Table A1.1: Dimensions

Size	FDZ			
	6/5 K	6/5	6/35 K	6/35
Length of the $\frac{\text{pin}}{\text{shaft}}$ $\frac{L_1}{L_2}$ [mm]	36	43	66	73
Diameter of the head $D \geq$	13			

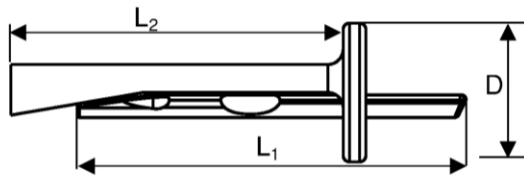

(Fig. not to scale)

fischer Ceiling Anchor FDZ

Product description

Product installation conditions, product marking and product dimensions

Annex A 1

Appendix 2 / 5

Specifications of intended use

Anchorage subject to:

Size	FDZ 6
Static and quasi-static loads	✓
Use for multiple fixture of non-structural applications according to ETAG 001, Part 6	
Fire exposure	

Base materials:

- Reinforced and unreinforced normal weight concrete according to EN 206-1:2000
- Strength classes C12/15 to C50/60 according to EN 206-1:2000
- Cracked and non-cracked concrete

Use conditions (Environmental conditions):

- Anchorage subject to dry internal conditions

Design:

- Anchorages are designed under the responsibility of an engineer experienced in anchorages and concrete work
- Verifiable calculation notes and drawings have to be prepared taking account of the loads to be anchored. The position of the anchor is indicated on the design drawings (e.g. position of the anchor relative to reinforcement or to supports, etc.).
- Anchorages under static or quasi-static actions have to be designed for Design Method C in accordance with:
 - ETAG 001, Annex C, Design Method C, Edition August 2010
 - CEN/TS 1992-4:2009
- Anchorages under fire exposure have to be designed in accordance with
 - EOTA Technical Report TR 020, Edition May 2004
 - CEN/TS 1992-4:2009, Annex D (it must be ensured that local spalling of the concrete cover does not occur)

fischer Ceiling Anchor FDZ

Intended use
Specifications

Annex B 1

Appendix 3 / 5

Table B2.1: Installation parameters

Size			FDZ			
			6/5 K	6/5	6/35 K	6/35
Thickness of the fixture	t_{fix}	\leq	5		35	
Nominal drill hole diameter	d_0		6			
Diameter of clearance hole in the fixture	d_f	\leq	7			
Maximum bit diameter	$d_{cut,max}$		6,40			
Effective embedment depth	h_{ef}	[mm]	25	32	25	32
Depth of drill hole to deepest point	with hole cleaning	h_1	30	37	30	37
	without hole cleaning		35	42	35	42
Minimum thickness of concrete member	h_{min}		80			

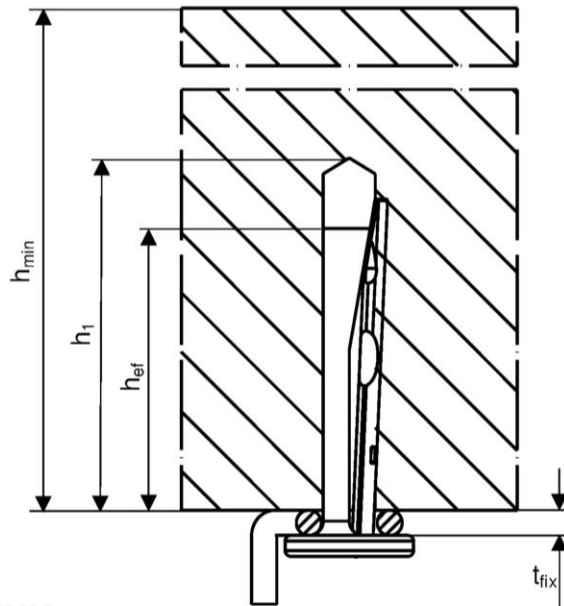

Installation instructions

- Hammer or hollow drilling only
- Anchor installation carried out by appropriately qualified personnel and under the supervision of the person responsible for technical matters of the site
- Positioning of the drill holes without damaging the reinforcement
- In case of aborted hole: New drilling at a minimum distance twice the depth of aborted hole away of or smaller distance if the aborted hole is filled with high strength mortar and if under shear or oblique tension load it is not in the direction of the load application

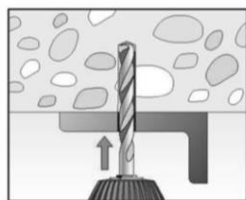

1: Drill the hole

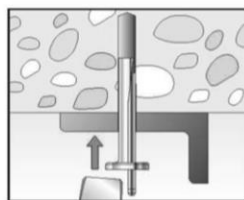

2: Set the fastener

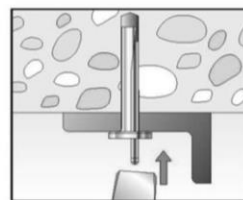

3: Set the pin, until flush to the surface

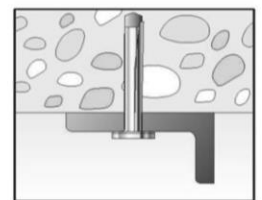

4: Installed fastener

(Fig. not to scale)

fischer Ceiling Anchor FDZ

Intended use

Installation parameters and installation instructions

Annex B 2

Appendix 4 / 5

Table C1.1: Characteristic resistance			
Size		FDZ 6	
For all load directions and for all failures modes			
Effective embedment depth	h_{ef} [mm]	25	32
Characteristic resistance in cracked and non-cracked concrete	C12/15	1,0	1,5
	C20/25 to C50/60	1,5	2,0
Characteristic edge distance	$c_{cr,N} = c_{min}$ [mm]	70	60
	spacing	$s_{cr,N} = s_{min}$	60
Partial safety factor	$\gamma_M^{2)}$ [-]	1,5	
Shear load with lever arm			
Characteristic bending resistance	$M_{Rk,s}^0$ [Nm]	4,4	
Partial safety factor for steel failure	$\gamma_{Ms}^1)$ [-]	1,25	
¹⁾ In absence of other national regulations ²⁾ The installation safety factor $\gamma_2 = \gamma_{inst} = 1,0$ is included			

Table C1.2: Characteristic resistance under fire exposure for all effective embedment depths

Size		FDZ 6	
Steel failure for tension and shear load			
R30	Characteristic resistance	$F_{Rk,s,fi30}$	1,00
R60		$F_{Rk,s,fi60}$	0,50
R90		$F_{Rk,s,fi90}$ [kN]	0,34
R120		$F_{Rk,s,fi120}$	0,26
R180		$F_{Rk,s,fi180}$	0,17
Spacing and edge distance			
R30 – R120		$s_{cr,fi}$ [mm]	200
		$c_{cr,fi}$	150

For fire exposure from more than one side $c_{min} \geq 300$ mm

fischer Ceiling Anchor FDZ	Annex C 1
Performances	
Characteristic resistance and characteristic resistance under fire exposure	Appendix 5 / 5