

PROHLÁŠENÍ O VLASTNOSTECH

DoP 0292

pro zarážecí kotva fischer EA II (mechanický kotevní prvek pro použití v betonu)

CS

- | | | |
|--|--|-------------------------|
| 1. <u>Jedinečný identifikační kód typu výrobku:</u> | DoP 0292 | |
| 2. <u>Zamýšlené/zamýšlená použití:</u> | Dodatečně instalovaný upevňovací prvek pro použití v betonu pro nekonstrukční systémy, viz. dodatek, obzvláště Přílohy B1-B4. | |
| 3. <u>Výrobce:</u> | fischerwerke GmbH & Co. KG, Klaus-Fischer-Str. 1, 72178 Waldachtal, Německo | |
| 4. <u>Zplnomocněný zástupce:</u> | - | |
| 5. <u>Systém/systémy POSV:</u> | 2+ | |
| 6. <u>Evropský dokument pro posuzování:</u> | EAD 330747-00-0601 | |
| Evropské technické posouzení: | ETA-07/0142; 2021-09-24 | |
| Subjekt pro technické posuzování: | DIBt- Deutsches Institut für Bautechnik | |
| Oznámený subjekt/oznámené subjekty: | 2873 TU Darmstadt | |
| 7. <u>Deklarovaná vlastnost/Deklarované vlastnosti:</u> | | |
| Bezpečnost při používání (BWR 4) | | |
| Charakteristická únosnost v tahu (pro statickou a kvazistatickou akci): | | |
| Odolnost proti selhání oceli: | NPD | |
| Odolnost proti selhání vytažením: | NPD | |
| Odolnost proti selhání betonu: | NPD | |
| Pevnost: | Přílohy C1, C2 | |
| Minimální vzdálenost od okraje a rozteč: | Přílohy B2, C2 | |
| Okrajová vzdálenost bráncí rozštěpení při zatížení: | NPD | |
| Charakteristická únosnost ve smyku (pro statickou a kvazistatickou akci): | | |
| Odolnost proti selhání oceli (smykové zatížení): | Přílohy C1, C2 | $V_{Rk,s}=NPD; k_7=NPD$ |
| Odolnost proti selhání rozštěpením: | NPD | |
| Odolnost proti selhání okraje betonu: | NPD | |
| Charakteristická únosnost pro všechny směry zatížení a způsoby porušení pro zjednodušený návrh: | | |
| Charakteristická únosnost: | Přílohy C1, C2 | |
| Životnost: | | |
| Životnost: | Přílohy A3, B1 | |
| Bezpečnost v případě požáru (BWR 2) | | |
| Reakce na oheň: | Třída (A1) | |
| Odolnost proti požáru: | | |
| Požární odolnost proti selhání oceli (tahové zatížení): | Příloze C3 | |
| Požární odolnost proti selhání vytažením (tahové zatížení): | Příloze C3 | |
| Požární odolnost proti selhání oceli (smykové zatížení): | Příloze C3 | |
| 8. <u>Příslušná technická dokumentace a/nebo specifická technická dokumentace:</u> | - | |

Vlastnosti výše uvedeného výrobku jsou ve shodě se souborem deklarovaných vlastností. Toto prohlášení o vlastnostech se v souladu s nařízením (EU) č. 305/2011 vydává na výhradní odpovědnost výrobce uvedeného výše.

Podepsáno za výrobce a jeho jménem:



Dr.-Ing. Oliver Geibig, Výkonný ředitel pro obchodní jednotky a inženýrství
Tumlingen, 2021-09-30



Jürgen Grün, Výkonný ředitel pro chemii a kvalitu

Toto PoV bylo připraveno v různých jazykových mutacích. V případě rozporu vždy rozhoduje interpretace verze v anglickém jazyce.

Příloha obsahuje nepovinné a doplňkové informace v anglickém jazyce nad rámec zákonných požadavků.

Specific Part

1 Technical description of the product

The fischer drop-in anchor EA II is an anchor made of galvanised or stainless steel which is placed into a drilled hole and anchored by deformation-controlled expansion.

The fixture shall be anchored with a fastening screw or threaded rod according to Annex B 5.

The product description is given in Annex A.

2 Specification of the intended use in accordance with the applicable European Assessment Document

The performances given in Section 3 are only valid if the anchor is used in compliance with the specifications and conditions given in Annex B.

The verifications and assessment methods on which this European Technical Assessment is based lead to the assumption of a working life of the anchor of at least 50 years. The indications given on the working life cannot be interpreted as a guarantee given by the producer, but are to be regarded only as a means for choosing the right products in relation to the expected economically reasonable working life of the works.

3 Performance of the product and references to the methods used for its assessment

3.1 Safety in case of fire (BWR 2)

Essential characteristic	Performance
Reaction to fire	Class A1
Resistance to fire	See Annex C 3

3.2 Safety and accessibility in use (BWR 4)

Essential characteristic	Performance
Characteristic resistance for all load directions and modes of failure for simplified design	See Annex C 1 and C 2
Durability	See Annex B 1

4 Assessment and verification of constancy of performance (AVCP) system applied, with reference to its legal base

In accordance with European Assessment Document EAD No. 330747-00-0601, the applicable European legal act is: [97/161/EC].

The system to be applied is: 2+

Only for use for redundant non-structural systems according to EN 1992-4:2018

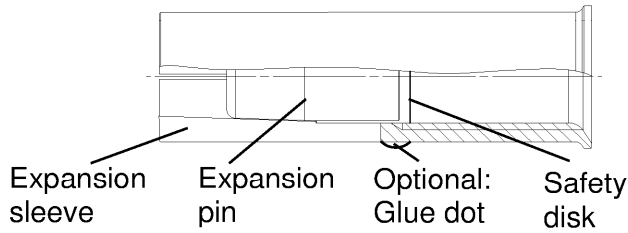
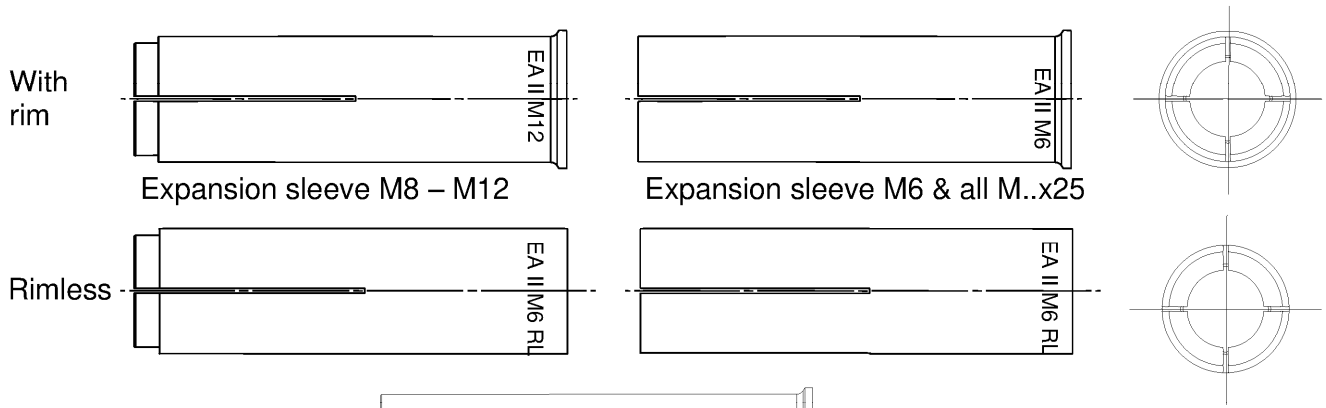

Intended use in concrete

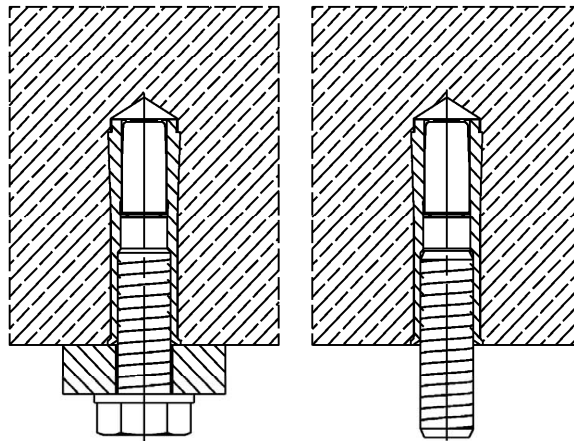

Intended use in precast pre-stressed hollow concrete slabs ($w/e \leq 4,2$) with a flange thickness $d_b \geq 35$ mm (or 30 mm → see Annex C2) and only for $h_{ef} = 25$ mm

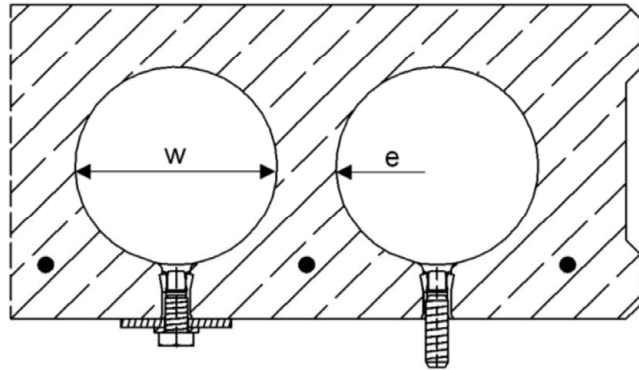

(Fig. not to scale)

fischer drop-in anchor EA II

Product description
 Installed condition
 Anchor types

Annex A 1

Expansion sleeve

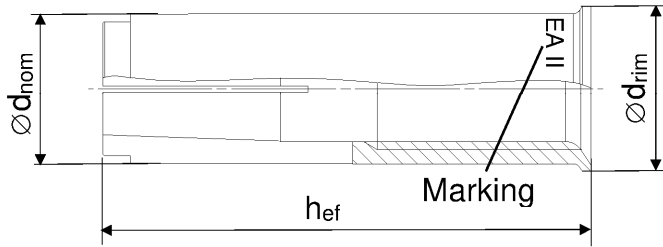

Expansion pin

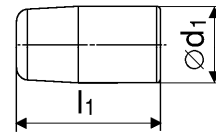
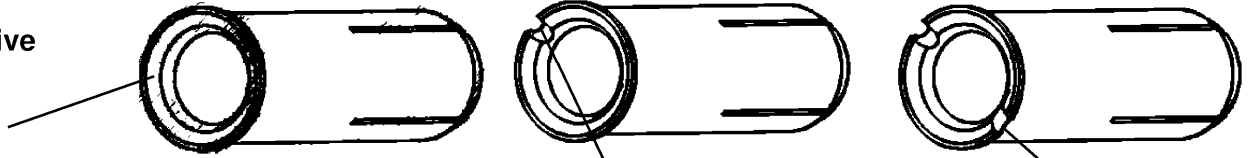

Table A2.1: Anchor size

Anchor size EA II [mm]	M6x25	M6x30	M8x25	M8x30	M8x40	M10x25	M10x30	M10x40	M12x25	M12x50	M12 D
hef	25	30	25	30	40	25	30	40	25	50	50
Ø d _{nom}	8		10			12			15		16
Ø d _{rim} (not applicable for EA II RL)	9,5		11,5			13,5			16,5		17,5
Ø d ₁	5		6,5			8,5	8		10		
l ₁	9	14	8	13,5		9	13,5	18,5	10,5	18,5	

Distinctive feature



No groove for:

- EA II M6x30..
- EA II M8x30..
- EA II M10x40..
- EA II M12x50..

1 groove for:

- EA II M6x25..
- EA II M8x25..
- EA II M10x25..
- EA II M12x25..

2 grooves for:

- EA II M8x40..
- EA II M10x30..

Table A2.2: Marking on anchor body

galvanised steel (gvz)		stainless steel (R)	
with rim	rimless	with rim	rimless
EA II M6x25	EA II M6x25 RL	EA II M6x30 R	EA II M6x30 RL R
EA II M6x30	EA II M6x30 RL	EA II M8x30 R	EA II M8x30 RL R
EA II M8x25	EA II M8x25 RL	EA II M8x40 R	EA II M8x40 RL R
EA II M8x30	EA II M8x30 RL	EA II M10x30 R	EA II M10x30 RL R
EA II M8x40	EA II M8x40 RL	EA II M10x40 R	EA II M10x40 RL R
EA II M10x25	EA II M10x25 RL	EA II M12x50 R	EA II M12x50 RL R
EA II M10x30	EA II M10x30 RL	EA II M12x50 D R	EA II M12x50 RL D R
EA II M10x40	EA II M10x40 RL		
EA II M12x25	EA II M12x25 RL		
EA II M12x50	EA II M12x50 RL		
EA II M12x50 D	EA II M12x50 RL D		

(Fig. not to scale)

fischer drop-in anchor EA II

Product description
Anchor types

Annex A 2

Appendix 3 / 12

Expansion sleeve

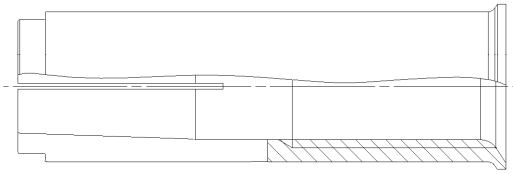

Expansion pin

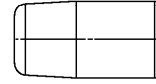
**Table A3.1: Materials**

Designation	Material	
	galvanised steel ($\geq 5 \mu\text{m}$)	stainless steel (R)
Expansion sleeve	EN 10277:2018 or EN 10084:2008 or EN 10111:2008 or EN 10263:2018 or EN 10087:1999 or ASTM A29/A29M	EN 10088:2014
Expansion pin		
Fastening screw or threaded rod	steel, property class 4.6, 5.6, 5.8 or 8.8 according to EN ISO 898-1:2013	property class 50, 70 or 80 according EN ISO 3506:2020

fischer drop-in anchor EA II

Product description
Materials

Annex A 3

Appendix 4 / 12

Setting & drilling tools

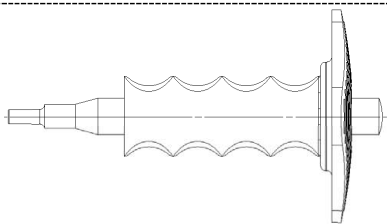
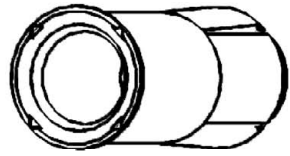
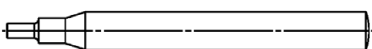
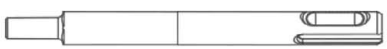
Setting tools	Marking	Description	Marking on EA II with rim and rimless
	EHS Plus M..x hef	Manual setting tool with hand guard	
	EHS M..x hef	Manual setting tool basic format	
	EMS M..x hef	Machine setting tool with SDS Plus	No marking

Drilling tools

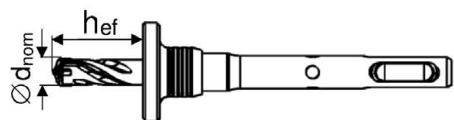

EBB
 $\varnothing_{nom} \times h_{ef}$

Stop drill

Or other usual drillers

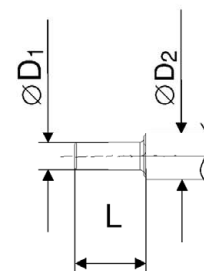

Table A4.1: Corresponding drill bits and parameters of setting tools

Manual setting tool	Machine setting tool	Stop drill	For anchor size	$\varnothing D1$ [mm]	$\varnothing D2$ [mm]	L [mm]
EHS (Plus) M6x25/30	EMS M6x25/30	EBB 8x25 EBB 8x30	EA II M6x25 EA II M6x30	4,8	9,0	17,0
EHS (Plus) M8x25/30	EMS M8x25/30	EBB 10x25 EBB 10x30	EA II M8x25 EA II M8x30	6,4	11,0	18,0
EHS (Plus) M8x40	EMS M8x40	EBB 10x40	EA II M8x40			28,0
EHS (Plus) M10x25/30	EMS M10x25/30	EBB 12x25 EBB 12x30	EA II M10x25 EA II M10x30	7,9	13,0	18,0
EHS (Plus) M10x40	EMS M10x40	EBB 12x40	EA II M10x40			24,0
EHS (Plus) M12x25	EMS M12x25	EBB 15x25	EA II M12x25	10,2	16,5	15,2
EHS (Plus) M12x50	EMS M12x50	EBB 15x50	EA II M12x50	10,2	16,5	30,0
EHS (Plus) M12x50	EMS M12x50	EBB 16x50	EA II M12x50 D			

(Fig. not to scale)

fischer drop-in anchor EA II



Intended Use
Setting & Drilling tools

Annex A 4

Appendix 5 / 12

Specifications of intended use

Anchorage subject to:

fischer drop-in anchor EA II (all versions)	M6	M8	M10	M12
Hammer drilling with standard drill bit 	All types			
Hammer drilling with hollow drill bit with automatic cleaning 				
Material	Steel	Zinc plated		
	Stainless steel	R		
Static and quasi-static loads	✓			
Cracked and uncracked concrete				
Fire exposure in concrete C12/15 to C50/60				
Fire exposure in prestressed hollow concrete slabs	No performance assessed			

Base materials:

- Compacted reinforced and unreinforced normal weight concrete without fibres (cracked and uncracked) according to EN 206:2013+A1:2016
- Strength classes C12/15 to C50/60 according to EN 206:2013+A1:2016
- Precast prestressed hollow concrete slabs with $w/e \leq 4,2$ and strength classes C30/37 to C50/60: M6x25, M8x25, M10x25 and M12x25

Use conditions (Environmental conditions):

- Structures subject to dry internal conditions: **EA II, EA II R**
- For all other conditions according to EN 1993-1-4:2006 + A1:2015 corresponding to corrosion resistance class CRC III **EA II R with $h_{ef} \geq 30$ mm**

Design:

- Anchorages are designed under the responsibility of an engineer experienced in anchorages and concrete work
- Verifiable calculation notes and drawings are prepared taking account of the loads to be anchored. The position of the anchor is indicated on the design drawings (e. g. position of the anchor relative to reinforcement or to supports, etc.)
- Only for use for redundant non-structural system according to EN 1992-4:2018, Chapter 7.3. Design Method B according to EN 1992-4:2018.
- Anchorages under fire exposure are designed according to EN 1992-4:2018 Annex D

Installation:

- Anchor installation carried out by appropriately qualified personnel and under the supervision of the person responsible for technical matters of the site
- Create drill hole with hammer drill or with hollow drill and vacuum cleaner
- The anchor may only be used once
- In case of aborted hole: New hole must be drilled at a minimum distance of twice the depth of the aborted hole or closer, if the hole is filled with a high strength mortar (e.g. FIS EM Plus, FIS SB or FIS V Plus) and only if the hole is not in the direction of the oblique tensile or shear load
- Anchor expansion by impact using the setting tools given in Annex A 4. The anchor is properly set, if the stop of the setting tool reaches the expansion sleeve. The manual setting tool with installation control leaves a visible mark on the sleeve, as illustrated in Annex A 4 and B 4

fischer drop-in anchor EA II

Intended Use
Specifications

Annex B 1

Appendix 6 / 12

Table B2.1: Installation parameters for concrete C12/15 to C50/60

Anchor size (all versions)			M6		M8			M10			M12		M12D
Nominal drill hole diameter	d_0	[mm]	8		10			12			15		16
Effective anchorage depth	h_{ef}	[mm]	25	30	25	30	40	25	30	40	25	50	50
Maximum installation torque	$T_{inst,max}$	[Nm]	4		8			15			35		
Minimum drill hole depth	h_1	[mm]	27	32	27	33	43	27	33	43	27	54	54
Minimum screw-in depth	$l_{s,min}$	[mm]	6		8			10			12		
Maximum screw-in depth	$l_{s,max}$	[mm]	14		14			14	15	17	14	22	
Clearance hole diameter	$\varnothing d_f \leq$	[mm]	7		9			12			14		
$h_{min} = 80$ mm													
Minimum spacing	S_{min}	[mm]	30	70	70	110	200	80	200		100	-	-
Minimum edge distance	C_{min}	[mm]	60	150	100	150		120	150		130	-	-
$h_{min} = 100$ mm													
Minimum spacing	S_{min}	[mm]	30	65	50	70		60	90	150	100	200	
Minimum edge distance	C_{min}	[mm]	60	115	100	115		100	160	180	110		
$h_{min} = 120$ mm													
Minimum spacing	S_{min}	[mm]	30	65	50	70		60	85	95	100	145	
Minimum edge distance	C_{min}	[mm]	60	115	100	115		100	140	150	110	200	

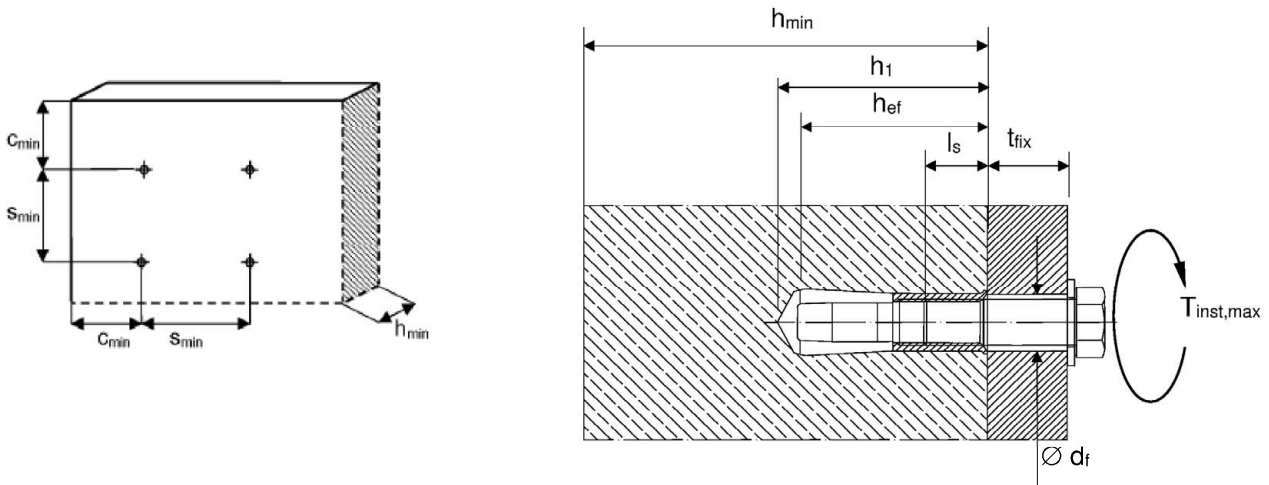

Fastening screw or threaded rod:

- Minimum property class and materials according to table A3.1
- The length of the fastening screw or threaded rod shall be determined depending on thickness of fixture t_{fix} , admissible tolerances and maximum screw-in depth $l_{s,max}$ as well as minimum screw-in depth $l_{s,min}$.

(Fig. not to scale)

fischer drop-in anchor EA II

Intended Use
Installation parameters

Annex B 2

Appendix 7 / 12

Table B3.1: Installation parameters for precast pre-stressed hollow concrete slabs

Anchor size (all versions)			M6	M8	M10	M12
Nominal drill hole diameter	d_0	[mm]	8	10	12	15
Effective anchorage depth	h_{ef}	[mm]	25			
Maximum installation torque	$T_{inst,max}$	[Nm]	4	8	15	35
Minimum drill hole depth	h_1	[mm]	27			
Minimum screw-in depth	$l_{s,min}$	[mm]	6	8	10	12
Maximum screw-in depth	$l_{s,max}$	[mm]	14			
Clearance hole diameter	$\varnothing d_f$	[mm]	7	9	12	14
Minimum spacing	$s_{min} = s_{cr}$	[mm]	200			
Minimum edge distance	$c_{min} = c_{cr}$	[mm]	150			

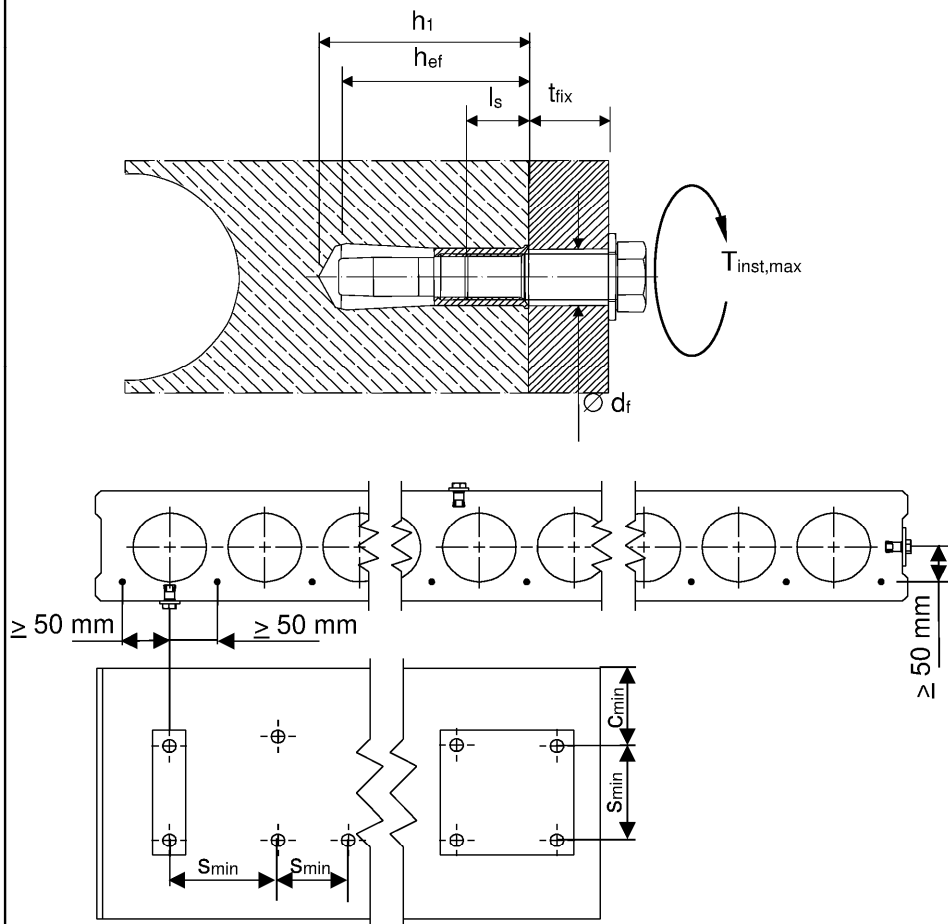

Fastening screw or threaded rod:

- Minimum property class and materials according to table A3.1
- The length of the fastening screw or threaded rod shall be determined depending on thickness of fixture t_{fix} , admissible tolerances and maximum screw-in depth $l_{s,max}$ as well as minimum screw-in depth $l_{s,min}$.

(Fig. not to scale)

fischer drop-in anchor EA II

Intended Use
Installation parameters

Annex B 3

Appendix 8 / 12

Installation instructions

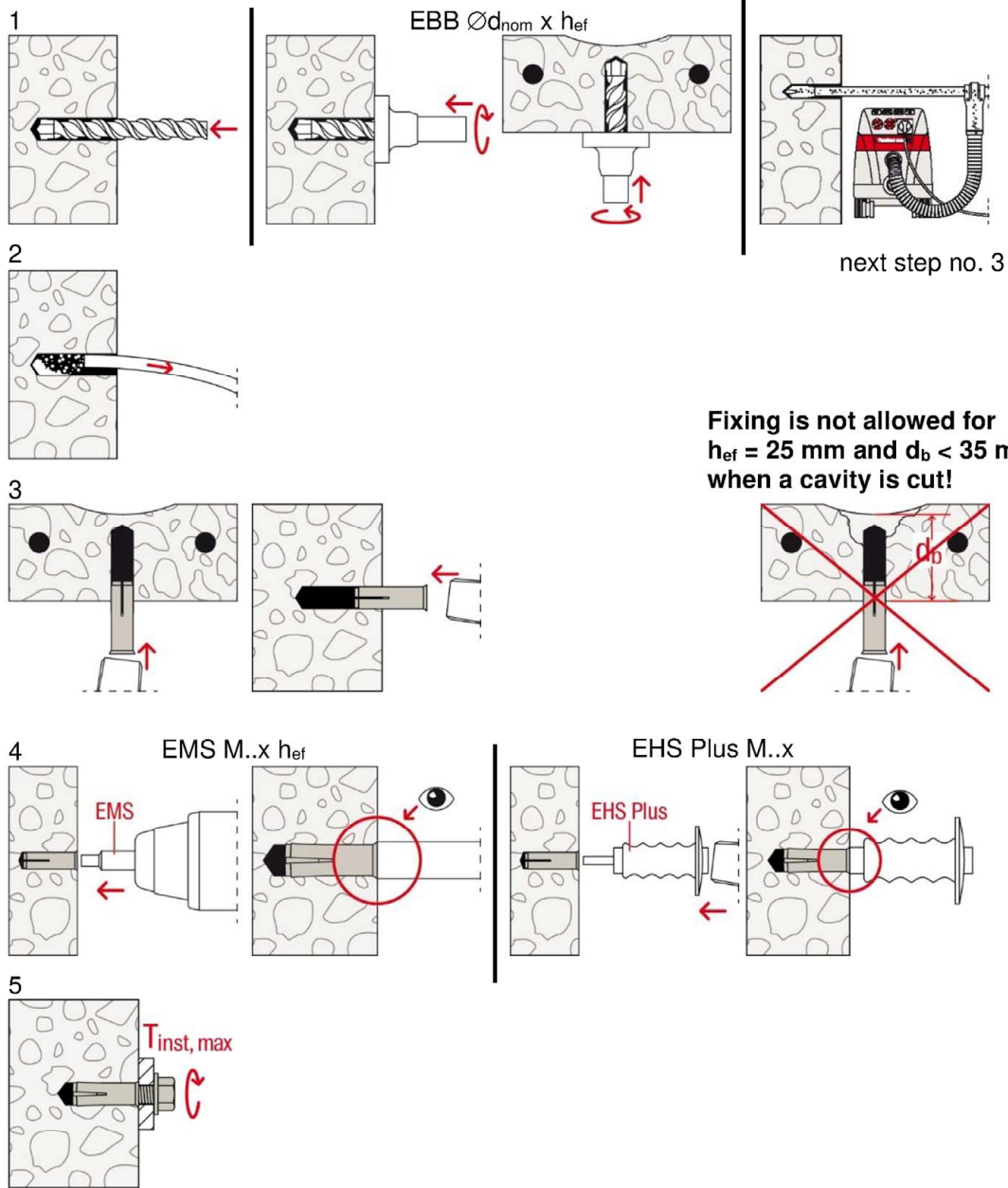

No.	Description
1	Create drill hole with hammer drill or stop drill or with hollow drill and vacuum cleaner
2	Clean from drill-dust
3	Set anchor till anchor is flush with surface of concrete
4	Expand the sleeve by driving the pin with the corresponding setting tool into the sleeve and control the correct setting
5	Fixation of fixture. Maximum installation torque $T_{\text{inst,max}}$ must not be exceeded

(Fig. not to scale)

fischer drop-in anchor EA II

Intended Use
Installation instructions

Annex B 4

Appendix 9 / 12

Table C1.1: Characteristic resistance of a fixing point¹⁾ for all load directions

Anchor size		property class of the fastening screw or threaded rod	M6		M8			M10			M12/ M12D	
Effective anchorage depth	h_{ef} [mm]		25	30	25	30	40	25	30	40	25	50
All load directions												
Characteristic resistance C12/15	F^{0}_{RK} [kN]	\geq A4-50	-2)	2	-2)	3		-2)	3	5	-2)	6
		\geq steel 4.6	1,5	2	3			3	3	9		
Characteristic resistance C20/25 to C50/60	F^{0}_{RK} [kN]	\geq A4-50	-2)	3	-2)	5		-2)	5	7,5	-2)	9
		\geq steel 4.6	2	3	5			4	4	9		
Installation factor	γ_{inst} [-]		1,0	1,2	1,0	1,2		1,0	1,2		1,0	
Characteristic spacing	s_{cr} [mm]		75	90	75	90	120	75	90	200	75	300
Characteristic edge distance	c_{cr} [mm]		38	45	38	45	60	38	45	100	38	150
Steel failure with lever arm												
Characteristic resistance	$M^{0}_{RK,s}$ [Nm]	A4-50	-2)	8	-2)	19		-2)	37		-2)	66
Partial factor	$\gamma_{Ms^{3)}$ [-]		2,38									
Characteristic resistance	$M^{0}_{RK,s}$ [Nm]	A4-70	-2)	11	-2)	26		-2)	52		-2)	92
Partial factor	$\gamma_{Ms^{3)}$ [-]		1,56									
Characteristic resistance	$M^{0}_{RK,s}$ [Nm]	A4-80	-2)	12	-2)	30		-2)	60		-2)	105
Partial factor	$\gamma_{Ms^{3)}$ [-]		1,33									
Characteristic resistance	$M^{0}_{RK,s}$ [Nm]	steel 4.6	6,1		15			30			52	
Partial factor	$\gamma_{Ms^{3)}$ [-]		1,67									
Characteristic resistance	$M^{0}_{RK,s}$ [Nm]	steel 5.6	7,6		19			37			66	
Partial factor	$\gamma_{Ms^{3)}$ [-]		1,67									
Characteristic resistance	$M^{0}_{RK,s}$ [Nm]	steel 5.8	7,6		19			37			66	
Partial factor	$\gamma_{Ms^{3)}$ [-]		1,25									
Characteristic resistance	$M^{0}_{RK,s}$ [Nm]	steel 8.8	12		30			60			105	
Partial factor	$\gamma_{Ms^{3)}$ [-]		1,25									

1) For definition see EN 1992-4:2018, Picture 3.4

2) No performance assessed

3) In absence of other national regulations

fischer drop-in anchor EA II

Performances

Characteristic values for tension loads in concrete according to design method B

Annex C 1

Appendix 10 / 12

Table C2.1: Characteristic values for $h_{ef} = 25$ mm in precast pre-stressed hollow concrete slabs according to design method C with C30/37 to C50/60

Anchor size		property class of the fastening screw or threaded rod	M6	M8	M10	M12
Effective anchorage depth	h_{ef} [mm]			25		
All Load directions			galvanised steel; with rim			
Flange thickness	d_b [mm]		≥ 35 (or 30 ¹⁾)			
Characteristic resistance C30/37 to C50/60	F^{0}_{RK} [kN]		2	3	4	
Installation factor	γ_{inst} [-]		1,0			
Characteristic spacing	$s_{cr} = s_{min}$ [mm]		200			
Characteristic edge distance	$c_{cr} = c_{min}$ [mm]		150			
Steel failure with lever arm						
Characteristic resistance	$M^{0}_{RK,s}$ [Nm]	steel 4.6	6,1	15	30	52
Partial factor	$\gamma_{Ms^{2)}$ [-]		1,67			
Characteristic resistance	$M^{0}_{RK,s}$ [Nm]	steel 5.6	7,6	19	37	66
Partial factor	$\gamma_{Ms^{2)}$ [-]		1,67			
Characteristic resistance	$M^{0}_{RK,s}$ [Nm]	steel 5.8	7,6	19	37	66
Partial factor	$\gamma_{Ms^{2)}$ [-]		1,25			
Characteristic resistance	$M^{0}_{RK,s}$ [Nm]	steel 8.8	12	30	60	105
Partial factor	$\gamma_{Ms^{2)}$ [-]		1,25			

¹⁾ The anchor may be used in a flange thickness d_b of minimum 30 mm with the same characteristic resistance, but the drill hole is not allowed to cut a cavity (see Annex B 4 Point 3). The use of the fischer stop drill EBB is recommended

²⁾ In absence of other national regulations

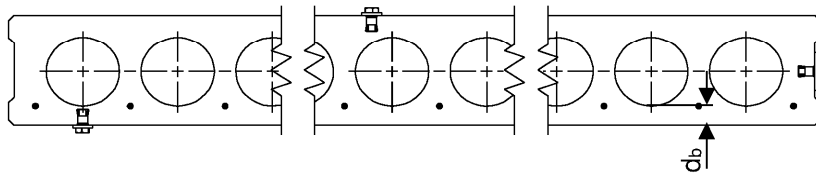

(Fig. not to scale)

fischer drop-in anchor EA II

Performances

Characteristic values for tension loads in hollow core slabs according to design method C with C30/37 to C50/60

Annex C 2

Appendix 11 / 12

Table C3.1: Characteristic resistance under fire exposure³⁾ in concrete C20/25 to C50/60

fire resistance class	EA II	property class of the fastening screw or threaded rod	M6x25	M6x30	M8x25	M8x30	M8x40	M10x25	M10x30	M10x40	M12x25	M12x50/ M12x50D
R 30	Characteristic resistance C20/25 to C50/60	F _{Rk,fi} ¹⁾ [kN]	steel ≥ 4.6 or ≥ A4-50 ²⁾	0,5	0,6	0,9	1,3	0,6	0,9	1,8	0,6	2,3
R 60				0,5	0,6	0,9	1,5					
R 90				0,4	0,6			0,9	0,5	1,3		
R 120				0,3	0,5			0,6				
R 30 – R 120	Characteristic spacing	S _{cr,fi} [mm]	100	120	100	120	160	100	120	160	100	200
	Characteristic edge distance	C _{cr,fi} [mm]	50	115	50	140	140	50	140	160	50	

¹⁾ In absence of other national regulations, a partial factor for the resistance of $\gamma_{m,fi} = 1,0$ under fire impact is recommended.

²⁾ Not for M..x25

³⁾ Not valid for precast pre-stressed hollow core slabs

Table C3.2: Characteristic resistance under fire exposure³⁾ for shear load with level arm in concrete C20/25 to C50/60

fire resistance class	EA II	property class of the fastening screw or threaded rod	M6x25	M6x30	M8x25	M8x30	M8x40	M10x25	M10x30	M10x40	M12x25	M12x50/ M12x50D
R 60	0,50	0,4	0,95	1,3	1,3	1,7	3,2	3,2	5,0	6,7		
R 90	0,35	0,3	0,60	0,8	0,8	1,0	1,9	1,9	2,9	3,9		
R 120	0,30	0,2	0,45	0,6	0,6	0,7	1,3	1,3	1,8	2,4		

¹⁾ In absence of other national regulations, a partial factor for the resistance of $\gamma_{m,fi} = 1,0$ under fire impact is recommended.

²⁾ Not for M..x25

³⁾ Not valid for precast pre-stressed hollow core slabs

In case of fire attack from more than one side, the edge distance shall be $c_{fi,min} \geq 300$ mm

fischer drop-in anchor EA II

Performances
Characteristic loads for fire resistances

Annex C 3

Appendix 12 / 12