

## PROHLÁŠENÍ O VLASTNOSTECH

### DoP 0347

pro rámovou kotvu fischer DuoXpand (Plastové hmoždinky pro použití do betonu a zdiva)

CS

1. Jedinečný identifikační kód typu výrobku: DoP 0347
2. Zamýšlené/zamýšlená použití: Plastová kotva pro vícenásobné použití v betonu a zdivu pro nekonstrukční aplikace (skupina základních materiálů a b, c, d), viz. dodatek, obzvláště Přílohy B1 - B5.
3. Výrobce: fischerwerke GmbH & Co. KG, Klaus-Fischer-Str. 1, 72178 Waldachtal, Německo
4. Zplnomocněný zástupce: -
5. Systém/systémy POSV: 2+
6. Evropský dokument pro posuzování: EAD 330284-00-0604-v01, Edition 05/2023  
Evropské technické posouzení: ETA-21/0324; 2023-10-19  
Subjekt pro technické posouzení: DIBt- Deutsches Institut für Bautechnik  
Oznámený subjekt/oznámené subjekty: 2873 TU Darmstadt
7. Deklarovaná vlastnost/Deklarované vlastnosti:  
**Bezpečnost v případě požáru (BWR 2)**  
Reakce na oheň: Třída A1  
Odolnost proti požáru (skupina základních materiálů a): Příloha C3  
Odolnost proti požáru (základní skupina materiálů b, c, d): Příloha C4  
  
**Mechanická odolnost a stabilita (BWR 4)**  
Odolnost proti porušení oceli při tahové zatížení: Příloha C1  
Odolnost proti porušení oceli nebo polymeru při smykovém zatížení: Příloha C1  
Odolnost proti vytažení nebo porušení betonu nebo porušení polymeru při tahovém zatížení (skupina základních materiálů a): Příloha C1  
  
Odolnost v libovolném směru zatížení bez ramene sil (základní skupina materiálů b, c, d): viz. dodatek, obzvláště Přílohy C9 - C15  
  
Okrajová a osová vzdálenost (skupina základních materiálů a): Příloha B2  
Okrajová a osová vzdálenost (skupina základních materiálů b, c, d): Přílohy B3, B4  
posuny při krátkodobém a dlouhodobém zatížení: Příloha C2  
  
**Životnost:**  
Životnost: Přílohy A3, B1
8. Příslušná technická dokumentace a/nebo specifická technická dokumentace: -

Vlastnosti výše uvedeného výrobku jsou ve shodě se souborem deklarovaných vlastností. Toto prohlášení o vlastnostech se v souladu s nařízením (EU) č. 305/2011 vydává na výhradní odpovědnost výrobce uvedeného výše.

Podepsáno za výrobce a jeho jménem:



Dr.-Ing. Oliver Geibig, Výkonný ředitel pro obchodní jednotky a inženýrství  
Tumlingen, 2023-11-02



Jürgen Grün, Výkonný ředitel pro chemii a kvalitu

Toto PoV bylo připraveno v různých jazykových mutacích. V případě rozporu vždy rozhoduje interpretace verze v anglickém jazyce.

Příloha obsahuje nepovinné a doplňkové informace v anglickém jazyce nad rámec zákonných požadavků.

Translation guidance Essential Characteristics and Performance Parameters for Annexes

**Pokyny pro překlad Základní charakteristiky a výkonnostní parametry příloh**

Safety in case of fire (BWR 2)

**Bezpečnost v případě požáru (BWR 2)**

1	Reaction to fire: <b>Reakce na oheň:</b>	-
2	Resistance to fire (base material group a): <b>Odolnost proti požáru (skupina základních materiálů a):</b>	$F_{Rk,fi}$ [kN]; $M_{Rk,s,fi}$ [Nm]; $c_{min,fi}$ [mm]
3	Resistance to fire (base material group b, c and d): <b>Odolnost proti požáru (skupina základních materiálů a):</b>	$F_{Rk,fi}$ [kN]; $M_{Rk,s,fi}$ [Nm]; $c_{min,fi}$ [mm]
Mechanical resistance and stability (BWR 4)		
<b>Mechanická odolnost a stabilita (BWR 4)</b>		
3	Resistance to steel failure under tension loading: <b>Odolnost proti porušení oceli při tahové zátěži:</b>	$N_{Rk,s}$ [kN]
4	Resistance to steel or polymer failure under shear loading: <b>Odolnost proti porušení oceli nebo polymeru při smykovém zatížení:</b>	$V_{Rk,s}$ [kN]; $M_{Rk,s}$ [Nm]; $V_{Rk,pol}$ [kN]
5	Resistance to pull-out or concrete failure or polymer failure under tension loading (base material group a) <b>Odolnost proti vytažení nebo porušení betonu nebo porušení polymeru při tahovém zatížení (skupina základních materiálů a):</b>	$N_{Rk,p}$ [kN] / $N_{Rk,pol}$ [kN]
6	Resistance in any load direction without lever arm (base material group b,c,d): <b>Odolnost v libovolném směru zatížení bez ramene sil (základní skupina materiálů b, c, d):</b>	$F_{Rk}$ [kN]
7	Edge distance and spacing (base material group a) <b>Okrajová a osová vzdálenost (skupina základních materiálů a):</b>	$c_{cr}$ ; $s_{cr}$ ; $c_{min}$ ; $s_{min}$ ; $a$ ; $h_{min}$ [mm]
8	Edge distance and spacing (base material group b,c,d): <b>Okrajová a osová vzdálenost (skupina základních materiálů b, c, d):</b>	$c_{min}$ ; $s_{min}$ ; $h_{min}$ [mm]
9	Displacements under short-term and long-term loading: <b>posuny při krátkodobém a dlouhodobém zatížení:</b>	$\delta_0$ ; $\delta_\infty$ [mm]
Aspects of durability		
<b>Životnost:</b>		
10	Durability: <b>Životnost:</b>	-

## Specific part

### 1 Technical description of the product

The fischer frame fixing DuoXpand 8 and DuoXpand 10 is a plastic anchor consisting of a plastic sleeve made of polyamide and polyoxymethylene and an accompanying specific screw of galvanised steel, of galvanised steel with an additional organic layer or of stainless steel.

The plastic sleeve is expanded by screwing in the specific screw which presses the sleeve against the wall of the drilled hole.

The product description is given in Annex A.

### 2 Specification of the intended use in accordance with the applicable European Assessment Document

The performances given in Section 3 are only valid if the anchor is used in compliance with the specifications and conditions given in Annex B.

The verifications and assessment methods on which this European Technical Assessment is based lead to the assumption of a working life of the anchors of at least 50 years. The indications given on the working life cannot be interpreted as a guarantee given by the producer, but are to be regarded only as a means for choosing the right products in relation to the expected economically reasonable working life of the works.

### 3 Performance of the product and references to the methods used for its assessment

#### 3.1 Safety in case of fire (BWR 2)

Essential characteristic	Performance
Reaction to fire	Class A1
Resistance to fire	See Annex C 3 and C 4

#### 3.2 Mechanical resistance and stability (BWR 4)

Essential characteristic	Performance
Resistance to steel failure under tension loading	See Annex C 1
Resistance to steel failure under shear loading	See Annex C 1
Resistance to pull-out or concrete failure under tension loading (base material group a)	See Annex C 1
Resistance in any load direction without lever arm (base material group b, c, d)	See Annexes C 9 – C 15
Edge distance and spacing (base material group a)	See Annex B 2
Edge distance and spacing (base material group b, c, d)	See Annex B 3 and B 4
Displacements under short-term and long-term loading	See Annex C 2

### 3.3 Aspects of durability linked with the Basic Works Requirements

Essential characteristic	Performance
Durability	See Annex B1

### 4 Assessment and verification of constancy of performance (AVCP) system applied, with reference to its legal base

In accordance with European Assessment Document EAD 330284-00-0604 the applicable European legal act is: 97/463/EC.

The system to be applied is: 2+

## Installed anchor DuoXpand

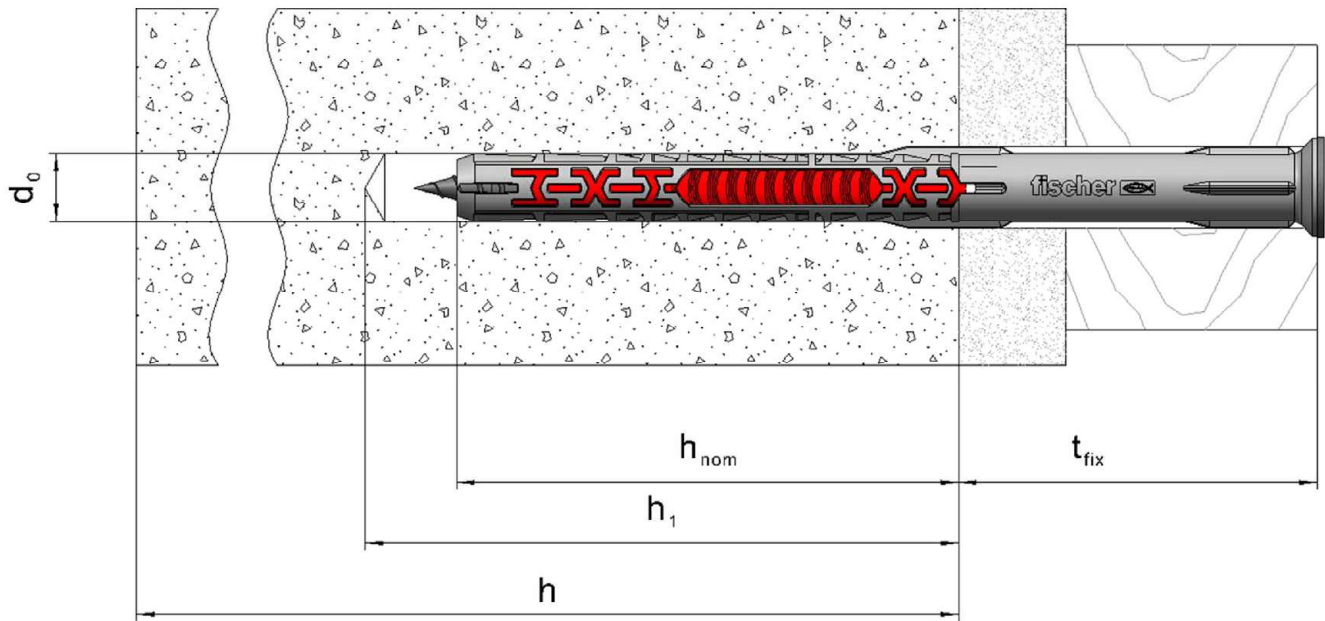

### Legend

- $d_0$  = Nominal drill hole diameter
- $h_{nom}$  = Overall plastic anchor embedment depth in the base material
- $h_1$  = Depth of drill hole to deepest point
- $h$  = Thickness of member (base material)
- $t_{fix}$  = Thickness of fixture and / or non-load-bearing layer

Figure not to scale

fischer frame fixing DuoXpand

Product description  
Installed anchor

Annex A 1

Appendix 3 / 25

### Anchor sleeves – flat collar version DuoXpand 8 and 10

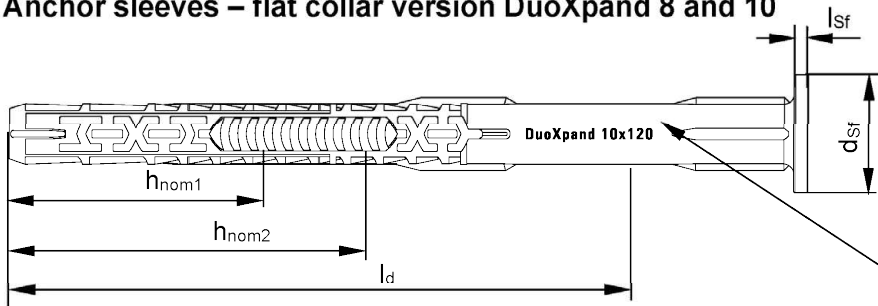

Marking:

Brand

Anchor type

Size

e.g.  DuoXpand 10x120

e.g.  DuoXpand 10x180

### Countersunk version DuoXpand 8 and 10

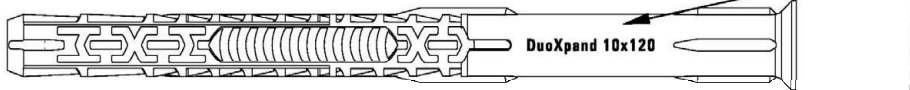

### Long version DuoXpand 10 with flat collar – countersunk version also available

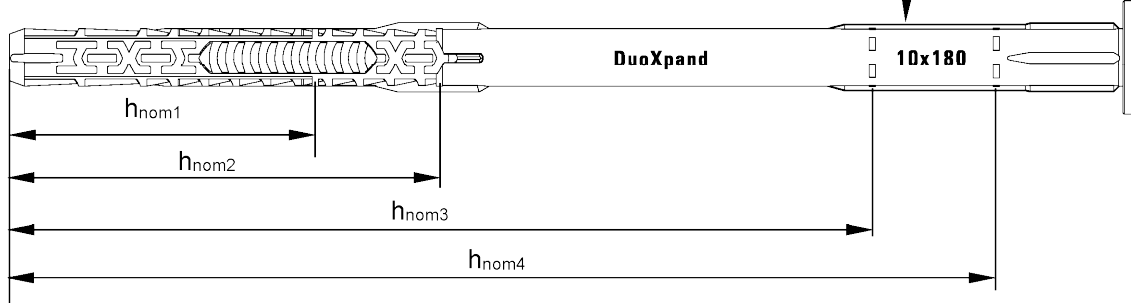

### Special screws

#### Countersunk screw

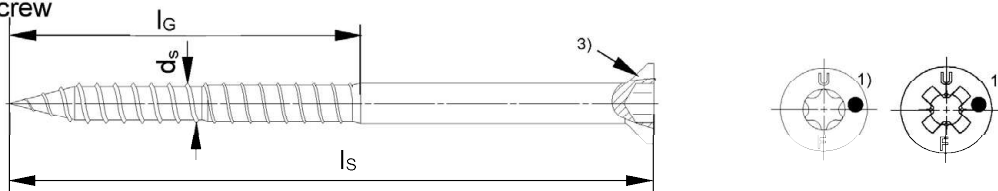

#### Hexagonal screw with washer

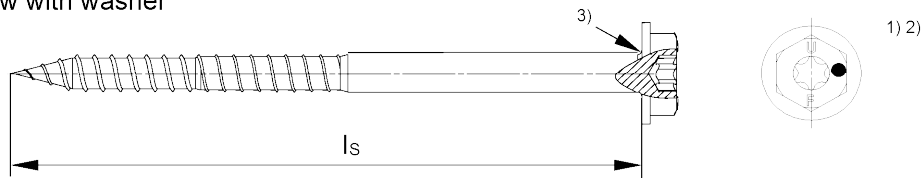

#### Hexagonal screw

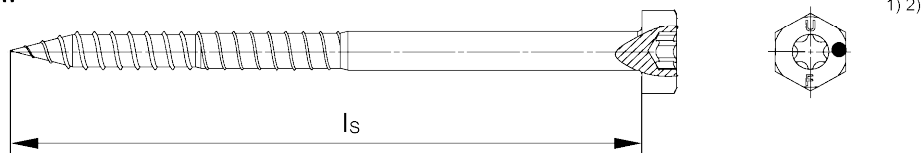

1) Additional marking for the special screw, stainless steel version: e.g. "A4" or "R" or "A2".

2) Internal driving feature for TX bit is optional for hexagonal head.

3) Optional additional version with underhead ribs.

Figures not to scale

## fischer frame fixing DuoXpand

### Product description

Anchor types, special screws  
Marking and dimensions

Annex A 2

Appendix 4 / 25

**Table A3.1: Dimensions**

Anchor type	Anchor sleeve							Special screw		
	$h_{nom}$ [mm]	$d_{nom}$ [mm]	$t_{fix}$ [mm]	min. $l_d$ [mm]	max. $l_d$ [mm]	$l_{sf}^{1)}$ [mm]	$d_{sf}^{1)}$ [mm]	$d_s$ [mm]	$l_G$ [mm]	$l_s$ [mm]
DuoXpand 8	50	8	$\geq 1$	80	120	1,6	14,0	6,0	77	$l_d + d_s$
	70									
DuoXpand 10	50	10	$\geq 1$	80	230	2,2	18,5	7,0	77	$l_d + d_s$
	70									
	140 <sup>2)</sup>									
	160 <sup>2)</sup>									

<sup>1)</sup> Only valid for flat collar version.

<sup>2)</sup> For base material Sepa Parpaing (see Annex C 13), additional  $h_{nom}$  available at  $l_d \geq 160$  mm.

**Table A3.2: Materials**

Name	Material
Anchor sleeve	- Polyamide, PA6, colour grey - Polyoxymethylene, POM, colour red
Special screw	- Galvanised steel gvz with Zn5/Ag or Zn5/An in accordance with EN ISO 4042  <u>or</u> - Galvanised steel gvz with Zn5/Ag or Zn5/An in accordance with EN ISO 4042 with additional organic layer (Zn5/Ag/T7 or Zn5/An/T7, respectively) in three layers (total layer thickness $\geq 6 \mu\text{m}$ )  <u>or</u> - Stainless steel "A2" of corrosion resistance class CRC II in accordance with EN 1993-1-4  <u>or</u> - Stainless steel "A4" or "R" of corrosion resistance class CRC III in accordance with EN 1993-1-4

fischer frame fixing DuoXpand

**Product description**  
Dimensions and materials

**Annex A 3**

Appendix 5 / 25

## Specifications of intended use

### Anchorage subject to:

- Static or quasi-static loads: DuoXpand 8 and DuoXpand 10.
- Redundant non-structural systems.
- Fire exposure for reinforced or unreinforced compacted normal weight concrete without fibres, strength classes  $\geq C20/25$  as per EN 206 and solid brick masonry (for dry masonry only) with mean compressive strength  $\geq 35 \text{ N/mm}^2$  as per EN 771, see Annex C 3 and Annex C 4: DuoXpand 10.

### Base materials:

- Reinforced or unreinforced compacted normal weight concrete without fibres, strength classes  $\geq C12/15$  (base material group "a"), as per EN 206, see Annex C 1 and C 5.
- Solid brick masonry (base material group "b") as per EN 771-1, EN 771-2 or EN 771-3, see Annex C 5, C 9, C 10. Note: The characteristic resistance is also valid for larger brick sizes and higher compressive strength of the masonry unit.
- Hollow brick masonry (base material group "c"), as per EN 771-1, EN 771-2 or EN 771-3, see Annex C 5 – C 8 and C 10 – C 14.
- Reinforced autoclaved aerated concrete (base material group "d"), as per EN 12602, and unreinforced autoclaved aerated concrete (base material group "d") as per EN 771-4, see Annex C 5 + C 15.
- Mortar strength class of the masonry  $\geq M2,5$  in accordance with EN 998-2. In case of fire, all joints must be completely filled with mortar.
- For other comparable base materials of the base material group "a", "b", "c" and "d" the characteristic resistance of the anchor may be determined by job site tests in accordance with EOTA TR 051.

### Temperature Range:

- c: - 40 °C to 50 °C (max. short term temperature + 50 °C and max long term temperature + 30 °C)
- b: - 40 °C to 80 °C (max. short term temperature + 80 °C and max long term temperature + 50 °C)

### Use conditions (Environmental conditions):

- Structures subject to dry internal conditions: Special screw made of zinc coated steel or stainless steel.
- The specific screw made of galvanised steel or galvanised steel with an additional organic layer may also be used in structures subject to external atmospheric exposure, if the area of the head of the screw is protected against moisture and driving rain after mounting of the fixing unit in this way, that intrusion of moisture into the anchor shaft is prevented. Therefore, there shall be an external cladding or a ventilated rainscreen mounted in front of the head of the screw and the head of the screw itself shall be coated with a soft plastic, permanently elastic bitumen-oil-combination coating (e.g. undercoating or body cavity protection for cars).
- Structures subject to external atmospheric exposure (including industrial and marine environment) and to permanently damp internal condition, if no particular aggressive conditions exist: Special screw made of stainless steel of corrosion resistance class CRC III.

Note: Particular aggressive conditions are e.g. permanent, alternating immersion in seawater or the splash zone of seawater, chloride atmosphere of indoor swimming pools or atmosphere with extreme chemical pollution (e.g. in desulphurization plants or road tunnels where de-icing materials are used).

### Design:

- The anchorages are to be designed in accordance with EOTA TR 064 under the responsibility of an engineer experienced in anchorages and concrete/masonry work.
- Verifiable calculation notes and drawings shall be prepared taking account of the loads to be anchored, the nature and strength of the base materials and the dimensions of the anchorage members as well as of the relevant tolerances. The position of the anchor is indicated on the design drawings.
- For requirements to resistance to fire local spalling of the concrete cover and cracks in masonry under fire exposure over 0,3 mm must be avoided.

### Installation:

- Hole drilling by the drilling method in accordance with Annex C 1 for base material group "a", and in accordance with Annexes C 9 – C 15 for base material group "b", "c" and "d".
- Anchor installation carried out by appropriately qualified personnel and under the supervision of the person responsible for technical matters of the site.
- Installation temperature: - 20 °C to + 40 °C.
- Exposure to UV due to solar radiation of the anchor not protected by rendering  $\leq 6$  weeks.
- No ingress of water in the borehole at temperatures  $< 0^\circ\text{C}$ .

fischer frame fixing DuoXpand

Intended use  
Specifications

Annex B 1

Appendix 6 / 25



**Table B2.1: Installation parameters**

Anchor type		DuoXpand 8	DuoXpand 10
Nominal drill hole diameter	$d_0 =$ [mm]	8	10
Cutting diameter of drill bit	$d_{cut} \leq$ [mm]	8,45	10,45
Overall plastic anchor embedment depth in the base material <sup>1)</sup>	$h_{nom1} \geq$ [mm]	50	50
	$h_{nom2} \geq$ [mm]	70	70
	$h_{nom3}^{2)} \geq$ [mm]	-	140
	$h_{nom4}^{2)} \geq$ [mm]	-	160
Depth of drill hole to deepest point	$h_{1,1} \geq$ [mm]	60	60
	$h_{1,2} \geq$ [mm]	80	80
	$h_{1,3}^{2)} \geq$ [mm]	-	150
	$h_{1,4}^{2)} \geq$ [mm]	-	170
Diameter of clearance hole in the fixture	$d_f \leq$ [mm]	8,5	10,5

<sup>1)</sup> For base material group "c": If the embedment depth is higher than  $h_{nom}$  given in the Table B2.1, job site tests have to be carried out in accordance with EOTA TR 051.

<sup>2)</sup> Only valid for Sepa Parpaing see Annex C 13 at anchor length  $l_d \geq 160$  mm.

**Table B2.2: Minimum thickness of member, edge distances and spacing in concrete – base material group "a"<sup>(1)</sup>**

Anchor Type	Embedment depth $h_{nom}$ [mm]	Concrete strength class	Minimum thickness of member $h_{min}$ [mm]	Characteristic edge distance $c_{cr}$ [mm]	Characteristic spacing $s_{cr}$ [mm]	Minimum edge distances and spacing <sup>2)</sup> $c_{min}, s_{min}$ [mm]
DuoXpand 8	$\geq 50$	C12/15	80	70	90	$s_{min} = 70$ for $c \geq 140$ $c_{min} = 70$ for $s \geq 140$
		$\geq$ C16/20		50	65	$s_{min} = 50$ for $c \geq 100$ $c_{min} = 50$ for $s \geq 100$
	$\geq 70$	C12/15	100	70	100	$s_{min} = 70$ for $c \geq 140$ $c_{min} = 70$ for $s \geq 140$
		$\geq$ C16/20		50	70	$s_{min} = 50$ for $c \geq 100$ $c_{min} = 50$ for $s \geq 100$
DuoXpand 10	$\geq 50$	C12/15	80	70	100	$s_{min} = 70$ for $c \geq 140$ $c_{min} = 70$ for $s \geq 140$
		$\geq$ C16/20		50	70	$s_{min} = 50$ for $c \geq 100$ $c_{min} = 50$ for $s \geq 100$
	$\geq 70$	C12/15	100	70	115	$s_{min} = 70$ for $c \geq 140$ $c_{min} = 70$ for $s \geq 140$
		$\geq$ C16/20		50	80	$s_{min} = 50$ for $c \geq 100$ $c_{min} = 50$ for $s \geq 100$

<sup>1)</sup> See scheme of edge distances and spacing Annex B 3.

<sup>2)</sup> Intermediate values by linear interpolation.

**Fixing points with spacing  $a \leq s_{cr}$  are considered as a group with a maximum characteristic resistance  $N_{RK,p}$  as per Table C1.2. For spacing  $a > s_{cr}$  the anchors are considered as single anchors, each with a characteristic resistance  $N_{RK,p}$  as per Table C1.2.**

**fischer frame fixing DuoXpand**

**Intended use**

Installation parameters

Minimum thickness of member, edge distances and spacing for use in concrete

**Annex B 2**

Appendix 7 / 25

**Table B3.1: Minimum thickness of member, edge distances and spacing in solid and hollow or perforated masonry – base material group “b” and “c”**

Anchor Type		DuoXpand 8	DuoXpand 10
Minimum thickness of member <sup>1)</sup>	$h_{min}$ [mm]	115	115
Spacing between anchor groups and / or single anchors	$a_{min}$ [mm]	250	250
<b>Single anchor</b>			
Minimum edge distance	$c_{min}$ [mm]	100	100
<b>Anchor group</b>			
Minimum spacing perpendicular to free edge	$s_{1,min}$ [mm]	100	100
Minimum spacing parallel to free edge	$s_{2,min}$ [mm]	100	100
Minimum edge distance	$c_{min}$ [mm]	100	100

<sup>1)</sup> Member thickness according to Annex C 5 – C 8.

**Scheme of edge distances and spacing**

in concrete, solid and hollow or perforated masonry  
base material group “a”, “b” and “c”

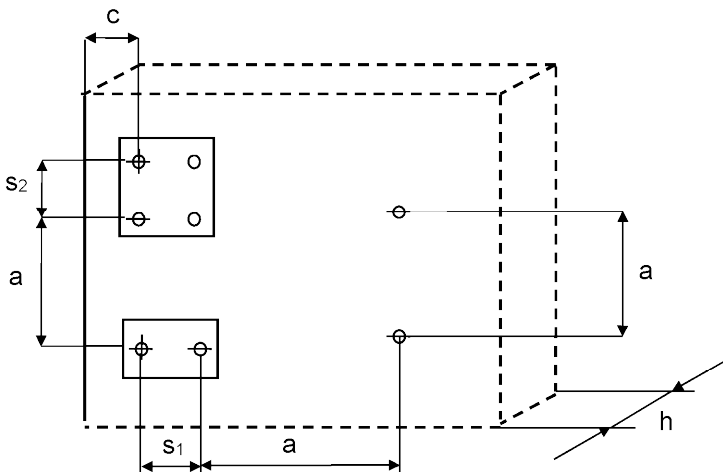

Figure not to scale

**fischer frame fixing DuoXpand**

**Intended use**

Minimum thickness of member, edge distances and spacing for use in solid, hollow or perforated masonry

**Annex B 3**

Appendix 8 / 25

**Table B4.1: Minimum thickness of member, edge distances and spacing in reinforced and unreinforced autoclaved aerated concrete – base material group “d”**

Anchor type		DuoXpand 8		DuoXpand 10	
Compressive strength <sup>1)</sup>	$f_{ck} / f_{cm,decl}$ [N/mm <sup>2</sup> ]	≥ 2	≥ 6	≥ 2	≥ 6
Nominal embedment depth	$h_{nom} \geq$ [mm]	70	70	70	70
Spacing between anchor groups and / or single anchors	$a_{min}$ [mm]	250	250	250	250
<b>Single anchor</b>					
Minimum thickness of member	$h_{min}$ [mm]	100	100	100	100
Minimum edge distance	$c_{min}$ [mm]	100	100	100	100
<b>Anchor group</b>					
Minimum thickness of member	$h_{min}$ [mm]	100	175	100	175
Minimum edge distance	$c_{min}$ [mm]	100	100	100	100
Minimum spacing perpendicular to free edge	$s_{1,min}$ [mm]	100	100	100	100
Minimum spacing parallel to free edge	$s_{2,min}$ [mm]	100	80	100	80

<sup>1)</sup> See Table C15.1 and C15.2.

**Scheme of edge distances and spacing**

in reinforced and unreinforced autoclaved aerated concrete base material group “d”

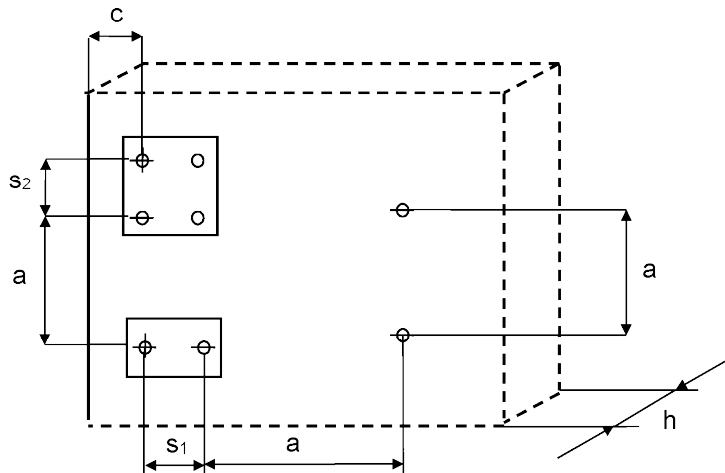

Figure not to scale

**fischer frame fixing DuoXpand**

**Intended use**

Minimum thickness of member, edge distances and spacing for use in reinforced and unreinforced autoclaved aerated concrete

**Annex B 4**

Appendix 9 / 25

## Installation instructions

The following pictures show fixing through timber in concrete and hollow brick –  
Summary of all kind of masonry bricks see Annex C 5 – C 8.

### Solid bricks

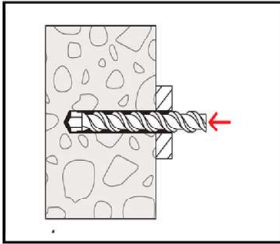

### Hollow or perforated bricks

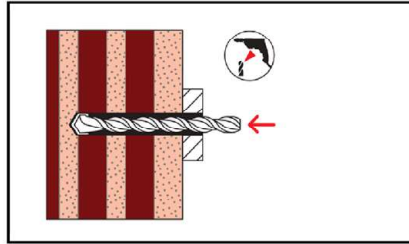

1. Drill the bore hole as per Table B2.1 using the drilling method described in the corresponding Annex C.

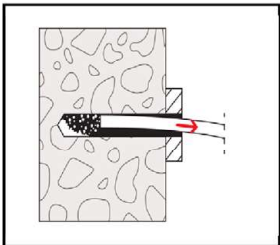

For application in hollow or perforated bricks, removal of bore dust is not necessary.

2. For use in base material group "a" (concrete), "b" (solid bricks), "d" (autoclaved aerated concrete): Remove dust from borehole.

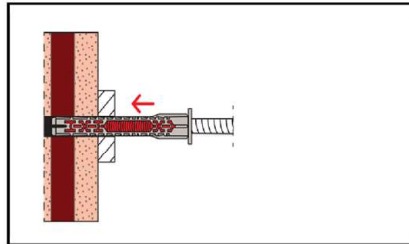
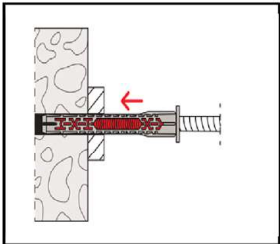

3. Insert anchor (screw and sleeve) by using a hammer until the collar of the plastic sleeve is flush with the surface of the fixture.

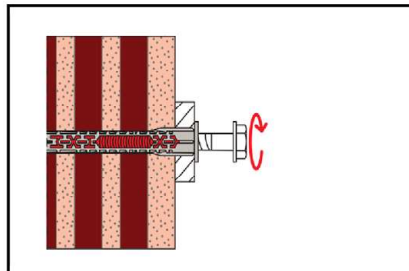
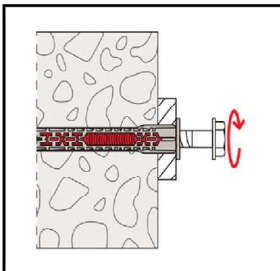

4. The screw is screwed-in until the head of the screw touches the sleeve. The anchor is correctly installed, if the head of the screw fits tight on the surface and nor the anchor sleeve neither the screw cannot be turned-in any further.

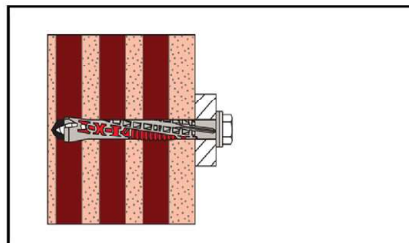
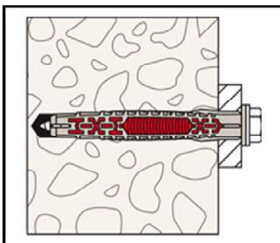

5. Correctly installed anchor.

fischer frame fixing DuoXpand

Intended use  
Installation instructions

Annex B 5

Appendix 10 / 25

**Table C1.1: Characteristic resistance of the screws**

Failure of expansion element (special screw)	DuoXpand 8		DuoXpand 10	
	galvanised steel	stainless steel	galvanised steel	stainless steel
Characteristic tension resistance $N_{Rk,s}$ [kN]	14,8	14,3	21,7	21,7
Partial factor $\gamma_{Ms}^{1)}$ [-]	1,50	1,55	1,55	1,55
Characteristic shear resistance $V_{Rk,s}$ [kN]	7,4	7,1	10,8	10,8
Partial factor $\gamma_{Ms}^{1)}$ [-]	1,25	1,29	1,29	1,29
<b>Characteristic bending resistance of the screw</b>				
Characteristic bending resistance $M_{Rk,s}$ [Nm]	12,4	12,0	20,6	20,6
Partial factor $\gamma_{Ms}^{1)}$ [-]	1,25	1,29	1,29	1,29

<sup>1)</sup> In absence of other national regulations.

**Table C1.2: Characteristic resistance due to pullout-failure for use in concrete – base material group “a”<sup>1)</sup>**

Pull-out failure (plastic sleeve)		DuoXpand 8		DuoXpand 10	
Embedment depth $h_{nom}$ [mm]	$\geq$	50	70	50	70
<b>Concrete <math>\geq</math> C12/15</b>					
Characteristic tension resistance (30/50 °C)	$N_{Rk,p}$ [kN]	3,5	4,0	3,5 / 4,0 <sup>2)</sup>	5,0
Characteristic tension resistance (50/80 °C)	$N_{Rk,p}$ [kN]	3,5	4,0	3,0 / 4,0 <sup>2)</sup>	4,5
Partial factor	$\gamma_{Mc}^{3)}$ [-]	1,8			

<sup>1)</sup> Drilling method: hammer drilling.

<sup>2)</sup> Valid for concrete  $\geq$  C16/20.

<sup>3)</sup> In absence of other national regulations.

fischer frame fixing DuoXpand

**Performances**

Characteristic resistance and characteristic bending resistance of the screw  
Characteristic resistance for use in concrete

**Annex C 1**

Appendix 11 / 25

**Table C2.1: Displacements<sup>1)</sup> under tension and shear loading in concrete, in solid bricks and in hollow or perforated bricks**

Displacements under			Tension load <sup>2)</sup>		Shear load <sup>2)</sup>	
Anchor type	$h_{nom}$ [mm]	F [kN]	$\delta_{NO}$ [mm]	$\delta_{N\infty}$ [mm]	$\delta_{VO}$ [mm]	$\delta_{V\infty}$ [mm]
DuoXpand 8	50	1,4	0,46	0,92	0,60	0,90
	70	1,6	0,45	0,90	0,63	0,95
DuoXpand 10	50	1,6	0,59	1,18	0,68	1,02
	70	2,0	0,58	1,16	0,88	1,32
	140 <sup>3)</sup>	1,6	0,59	1,18	0,68	1,02
	160 <sup>3)</sup>	2,0	0,58	1,16	0,88	1,32

<sup>1)</sup> Valid for all ranges of temperatures.

<sup>2)</sup> Intermediate values by linear interpolation.

<sup>3)</sup> Only valid for Sepa Parpaing see Annex C 13.

**Table C2.2: Displacements<sup>1)</sup> under tension and shear loading in reinforced and unreinforced autoclaved aerated concrete**

Displacements under				Tension load <sup>2)</sup>		Shear load <sup>2)</sup>	
Anchor type	$f_{ck} / f_{cm,decl}$ [N/mm <sup>2</sup> ]	$h_{nom}$ [mm]	F [kN]	$\delta_{NO}$ [mm]	$\delta_{N\infty}$ [mm]	$\delta_{VO}$ [mm]	$\delta_{V\infty}$ [mm]
DuoXpand 8	$\geq 2$	70	0,11	0,13	0,26	0,22	0,33
	$\geq 6$	70	0,71	0,68	1,36	1,42	2,13
DuoXpand 10	$\geq 2$	70	0,18	0,12	0,24	0,36	0,54
	$\geq 6$	70	0,32	0,66	1,32	0,64	0,96

<sup>1)</sup> Valid for all ranges of temperatures.

<sup>2)</sup> Intermediate values by linear interpolation.

fischer frame fixing DuoXpand

**Performances**

Displacements under tension and shear loading in concrete, masonry and autoclaved aerated concrete

**Annex C 2**

Appendix 12 / 25

**Figure C3.1: Characteristic fire resistance under inclined loading, load direction  $\alpha$ , in concrete – base material group “a” and solid brick masonry – base material group “b”**

The characteristic fire resistance for each fire resistance class shall be interpolated for load direction  $\alpha$  between  $45^\circ$  and  $90^\circ$  according to following equation:

$$F_{Rk,fi}(\alpha) = \frac{0,71 \cdot F_{Rk,fi}(45^\circ)}{\cos \alpha} \leq F_{Rk,fi}(90^\circ)$$

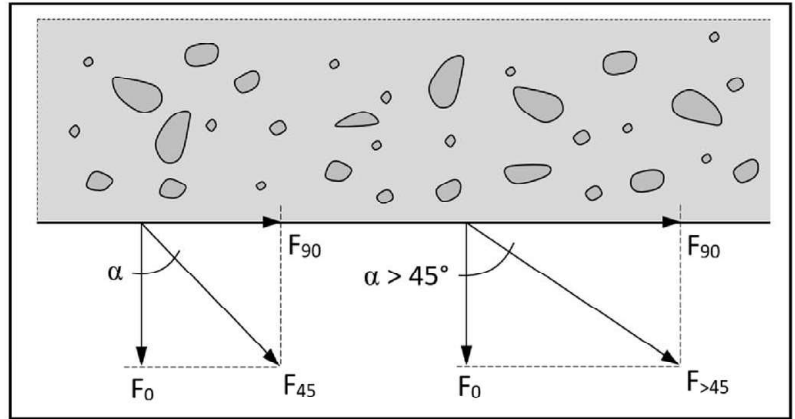

**Table C3.1: Characteristic fire resistance in concrete  $\geq$  C20/25 – base material group “a”**

			DuoXpand 10			
			R30	R60	R90	R120
Embedment depth	$h_{nom} \geq$ [mm]		70			
<b>Characteristic fire resistance under inclined loading for selected load directions <math>\alpha</math></b>						
$\alpha = 45^\circ$	$F_{Rk,fi}(45^\circ)$ [kN]		0,51	0,34	0,17	.. <sup>2)</sup>
$\alpha = 60^\circ$	$F_{Rk,fi}(60^\circ)$ [kN]		0,72	0,48	0,24	.. <sup>2)</sup>
$\alpha = 75^\circ$	$F_{Rk,fi}(75^\circ)$ [kN]		1,39	0,93	0,46	.. <sup>2)</sup>
Partial factor	$\gamma_{M,fi}$ <sup>1)</sup> [-]		1,0			
<b>Characteristic fire resistance for shear load without lever arm</b>						
Characteristic shear resistance	$F_{Rk,fi}(90^\circ)$ [kN]		2,30	1,80	1,30	1,05
Partial factor	$\gamma_{M,fi}$ <sup>1)</sup> [-]		1,0			
<b>Characteristic fire resistance for shear load with lever arm</b>						
Characteristic bending resistance	$M_{Rk,s,fi}$ <sup>3)</sup> [Nm]		2,41	1,89	1,37	1,10
Partial factor	$\gamma_{M,fi}$ <sup>1)</sup> [-]		1,0			
Minimum edge distances under fire exposure	$c_{min,fi}$ [mm]		$2 \times h_{nom}$			
Minimum spacing under fire exposure	$s_{min,fi}$ [mm]		$4 \times h_{nom}$			

<sup>1)</sup> In absence of other national regulations.

<sup>2)</sup> No performance assessed.

<sup>3)</sup> Shear load with lever arm is to be limited to a maximum acting load  $F_{Rk,fi}(45^\circ)$ .

**Table C3.2: Values under fire exposure in concrete C20/25 to C50/60 in any load direction (no permanent centric tension load, only for shear load without lever arm)  
Fastening of façade systems**

Anchor type	Fire resistance class	Load direction $\alpha$	$F_{Rk,fi,90}$	$\gamma_{M,fi}$ <sup>1)</sup>
DuoXpand 10	R90	$\geq 81^\circ$	0,8 kN	1,0

<sup>1)</sup> In absence of other national regulations.

**fischer frame fixing DuoXpand**

**Performances**

Characteristic fire resistance for use in concrete

<b>Table C4.1: Characteristic fire resistance in solid brick masonry– base material group “b”</b>						
<b>Base material; bulk density [kg/dm<sup>3</sup>]; mean compressive strength [N/mm<sup>2</sup>] [Supplier Title, country] Geometry, DF or nominal size (L x W x H) [mm] drilling method</b>			<b>Anchor type</b>			
<b>Clay brick Mz; <math>\rho \geq 1,8</math>; 35 as per EN 771-1 e.g. Mz Ziegelwerk Nordhausen, DE; NF (240x115x71)</b> Hammer drilling			<b>DuoXpand 10</b>			
<b>Calcium silicate solid brick KS; <math>\rho \geq 2,0</math>; 35 as per EN 771-2 e.g. KS Wemding, DE; NF (240x115x71)</b> Hammer drilling						
			<b>R30</b>	<b>R60</b>	<b>R90</b>	<b>R120</b>
Embedment depth	<b><math>h_{nom}</math></b>	<b><math>\geq</math> [mm]</b>	<b>70</b>			
<b>Characteristic fire resistance under inclined loading for selected load directions <math>\alpha</math></b>						
$\alpha = 45^\circ$	<b><math>F_{Rk,fi}(45^\circ)</math></b>	[kN]	<b>0,51</b>	<b>0,34</b>	<b>0,17</b>	<b>-<sup>2)</sup></b>
$\alpha = 60^\circ$	<b><math>F_{Rk,fi}(60^\circ)</math></b>	[kN]	<b>0,72</b>	<b>0,48</b>	<b>0,24</b>	<b>-<sup>2)</sup></b>
$\alpha = 75^\circ$	<b><math>F_{Rk,fi}(75^\circ)</math></b>	[kN]	<b>1,30</b>	<b>0,93</b>	<b>0,46</b>	<b>-<sup>2)</sup></b>
Partial factor	<b><math>\gamma_{M,fi}</math><sup>1)</sup></b>	[-]	<b>1,0</b>			
<b>Characteristic fire resistance for shear load without lever arm</b>						
Characteristic shear resistance	<b><math>F_{Rk,fi}(90^\circ)</math></b>	[kN]	<b>1,30</b>			<b>1,05</b>
Partial factor	<b><math>\gamma_{M,fi}</math><sup>1)</sup></b>	[-]	<b>1,0</b>			
<b>Characteristic fire resistance for shear load with lever arm</b>						
Characteristic bending resistance	<b><math>M_{Rk,s,fi}</math></b>	[Nm]	<b>2,41</b>	<b>1,89</b>	<b>1,37</b>	<b>1,10</b>
Partial factor	<b><math>\gamma_{M,fi}</math><sup>1)</sup></b>	[-]	<b>1,0</b>			
Minimum edge distances under fire exposure	<b><math>c_{min,fi}</math></b>	[mm]	<b><math>2 \times h_{nom}</math></b>			
Minimum spacing under fire exposure	<b><math>s_{min,fi}</math></b>	[mm]	<b><math>4 \times h_{nom}</math></b>			
<sup>1)</sup> In absence of other national regulations. <sup>2)</sup> No performance assessed.						
<b>fischer frame fixing DuoXpand</b>						<b>Annex C 4</b> Appendix 14 / 25
<b>Performances</b> Characteristic fire resistance for use in solid brick masonry						



**Table C5.1: Summary of base materials concrete group “a”, solid bricks group “b”<sup>1)</sup> and autoclaved aerated concrete group “d”**

Base material	Format	Dimensions (L x W x H) [mm]	Mean compressive strength as per EN 771 [N/mm <sup>2</sup> ]	Bulk density ρ [kg/dm <sup>3</sup> ]	See Annex
<b>Concrete ≥ C12/15</b> as per EN 206					C 1
<b>Autoclaved aerated concrete</b> as per EN 771-4					C 15
<b>Reinforced autoclaved aerated concrete, AAC</b> as per EN 12602					C 15
<b>Clay brick Mz</b> , as per EN 771-1, <i>e.g. Mz Ziegelwerk Nordhausen, DE</i>	NF	240x115x71	≥ 10	≥ 1,8	C 9
<b>Calcium silicate solid brick KS</b> , as per EN 771-2, <i>e.g. KS Wemding, DE</i>	NF	240x115x71	≥ 10	≥ 2,0	C 9
<b>Calcium silicate solid brick KS</b> , as per EN 771-2, <i>e.g. KS Wemding, DE</i>	12 DF	498x175x248	≥ 10	≥ 1,8	C 9
<b>Lightweight solid brick Vbl</b> , as per EN 771-3, <i>e.g. Vbl KLB, DE</i>	2 DF	240x115x113	≥ 2,5	≥ 1,4	C 10

<sup>1)</sup> Vertically perforation ≤ 15%; cross section reduced by perforation vertically to the resting area.

**Table C5.2: Summary of hollow or perforated bricks – base material group “c”<sup>(1)</sup>**

Base material	Format/ Dimensions (L x W x H) [mm]	Brick drawing [mm]	Mean compressive strength as per EN 771 [N/mm <sup>2</sup> ] / bulk density ρ [kg/dm <sup>3</sup> ]	See Annex
<b>Perforated clay brick Hlz</b> , as per EN 771-1, <i>e.g. Wienerberger Hlz, DE</i>	2 DF 240 x 115 x 113		≥ 5,0 /  ρ ≥ 0,9	C 10

<sup>1)</sup> Vertically perforation > 15 % and ≤ 50 %, cross section reduced by perforation vertically to the resting area.

Figure not to scale

<b>fischer frame fixing DuoXpand</b>	<b>Annex C 5</b> Appendix 15 / 25
<b>Performances</b> Summary of base materials concrete, solid bricks, autoclaved aerated concrete and hollow or perforated bricks	

Table C6.1: Summary of hollow or perforated bricks – base material group “c”<sup>(1)</sup>

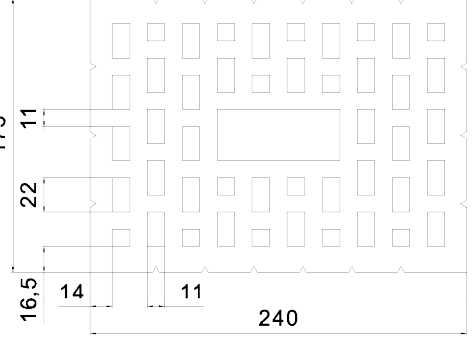
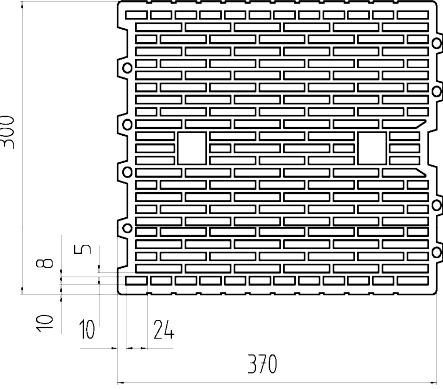
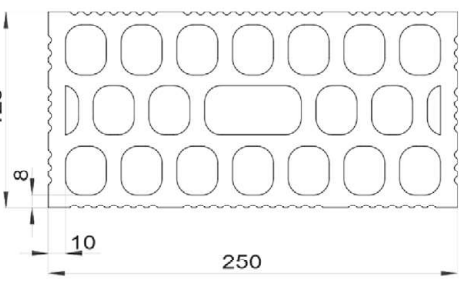
Base material	Format/ Dimensions (L x W x H)  [mm]	Brick drawing  [mm]	Mean compressive strength as per EN 771 [N/mm <sup>2</sup> ] / bulk density ρ [kg/dm <sup>3</sup> ]	See Annex
<p><b>Perforated clay brick HLz,</b> as per EN 771-1, e.g. <i>Schlagmann, DE</i></p>	<p>3 DF 240x175x113</p>		<p>≥ 5,0 / ρ ≥ 0,9</p>	<p>C 10</p>
<p><b>Perforated clay brick HLz,</b> as per EN 771-1, e.g. <i>Wienerberger Porotherm 30 R, FR</i></p>	<p>370x300x250</p>		<p>≥ 7,5 / ρ ≥ 0,7</p>	<p>C 11</p>
<p><b>Perforated clay brick HLz,</b> as per EN 771-1, e.g. <i>Doppio Uni IT Wienerberger, IT</i></p>	<p>250x120x190</p>		<p>≥ 5,0 / ρ ≥ 0,9</p>	<p>C 11</p>

<sup>1)</sup> Vertically perforation > 15 % and ≤ 50 %, cross section reduced by perforation vertically to the resting area.

Figures not to scale

fischer frame fixing DuoXpand

**Performances**  
Summary of base materials hollow or perforated bricks

**Annex C 6**

Appendix 16 / 25

**Table C7.1: Summary of hollow or perforated bricks – base material group “c”<sup>(1)</sup>**

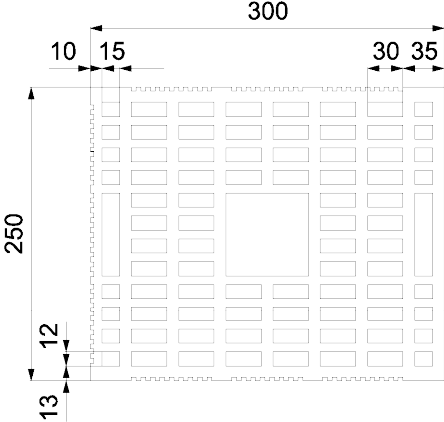
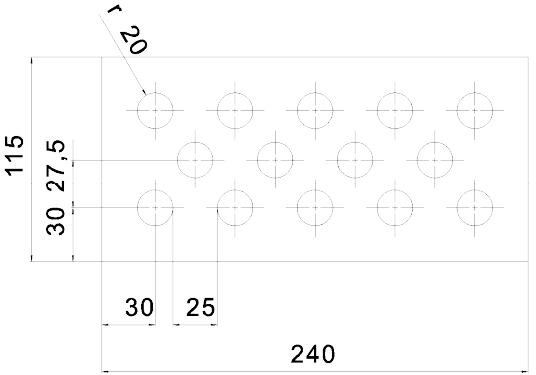
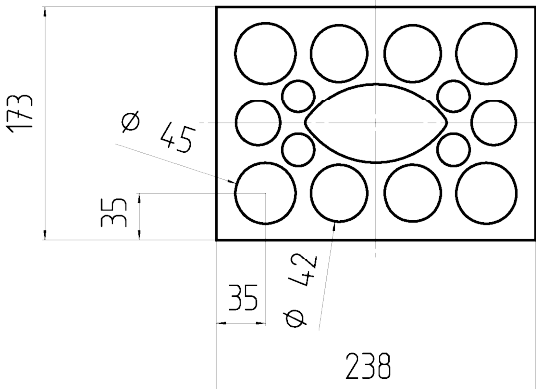
Base material	Format/ Dimensions (L x W x H)  [mm]	Brick drawing  [mm]	Mean compressive strength as per EN 771 [N/mm <sup>2</sup> ] / bulk density ρ [kg/dm <sup>3</sup> ]	See Annex
<p><b>Perforated clay brick HLz</b>, as per EN 771-1, <i>e.g. Wienerberger Pth Bio Modulare, DE</i></p>	<p>8 DF 300x250x190</p>		<p>≥ 7,5 / ρ ≥ 1,0</p>	<p>C 11</p>
<p><b>Calcium silicate hollow brick KSL</b>, as per EN 771-2, <i>e.g. Bösel, DE</i></p>	<p>2 DF 240x115x113</p>		<p>≥ 10 / ρ ≥ 1,6</p>	<p>C 12</p>
<p><b>Calcium silicate hollow brick KSL</b>, as per EN 771-2, <i>e.g. KS Wemding, DE</i></p>	<p>3 DF 240x175x113</p>		<p>≥ 10 / ρ ≥ 1,4</p>	<p>C 12</p>

<sup>1)</sup> Vertically perforation > 15 % and ≤ 50 %, cross section reduced by perforation vertically to the resting area.

Figures not to scale

**fischer frame fixing DuoXpand**

**Performances**  
Summary of base materials hollow or perforated bricks

**Annex C 7**  
Appendix 17 / 25

Table C8.1: Summary of hollow or perforated bricks – base material group “c”<sup>(1)</sup>

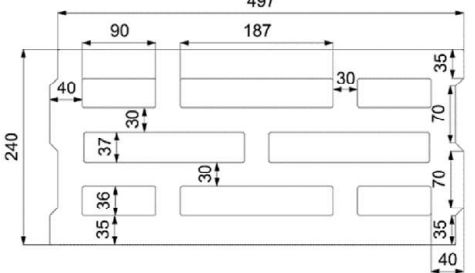
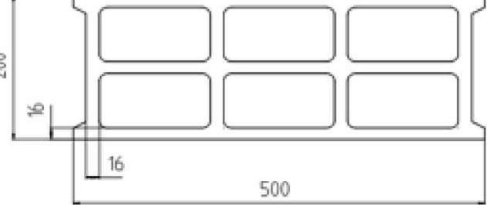
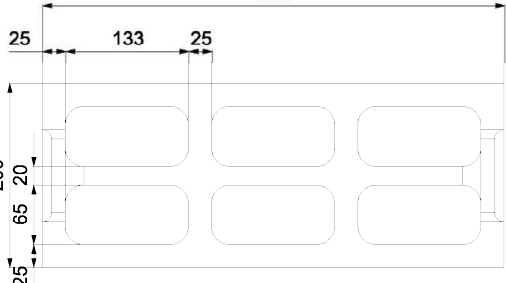
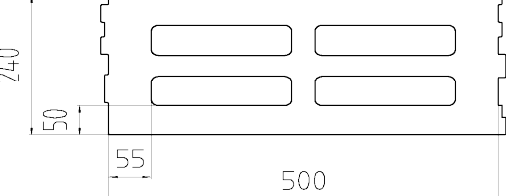
Base material	Format/ Dimensions (L x W x H)  [mm]	Brick drawing  [mm]	Mean compressive strength as per EN 771 [N/mm <sup>2</sup> ] / bulk density ρ [kg/dm <sup>3</sup> ]	See Annex
<b>Hollow brick lightweight concrete Hbl</b> , as per EN 771-3, e.g. <i>Knobel, DE</i>	16DF 495x240x248		≥ 2,5 / ρ ≥ 0,7	C 12
<b>Hollow brick lightweight concrete Hbl</b> , as per EN 771-3, e.g. <i>Sepa Parpaing, FR</i>	500x200x200		≥ 2,5 / ρ ≥ 1,0	C 13
<b>Hollow brick lightweight concrete Hbl</b> , as per EN 771-3, e.g. <i>Indelasa, ES</i>	500x200x200		≥ 2,5 / ρ ≥ 1,0	C 14
<b>Hollow brick lightweight concrete Hbl</b> , as per EN 771-3, e.g. <i>Knobel, DE</i>	500x240x240		≥ 2,5 / ρ ≥ 0,9	C 14

<sup>1)</sup> Vertically perforation > 15 % and ≤ 50 %, cross section reduced by perforation vertically to the resting area.

Figures not to scale

fischer frame fixing DuoXpand

**Performances**

Summary of base materials hollow or perforated bricks

**Annex C 8**

Appendix 18 / 25

**Table C9.1: Characteristic resistance  $F_{Rk}$  in [kN] for use in solid masonry - base material group "b"**

Base material; bulk density [kg/dm <sup>3</sup> ] [Supplier Title, country] Geometry, DF or nominal size (L x W x H) [mm] and drilling method	Mean compressive strength as per EN 771/ Minimum compressive strength single brick <sup>9)</sup> [N/mm <sup>2</sup> ]	Characteristic resistance $F_{Rk}$ [kN] Temperature range 30/50 °C and 50/80 °C			
		DuoXpand 8		DuoXpand 10	
		$h_{nom}$ [mm]			
		≥ 50	≥ 70	≥ 50	≥ 70
<b>Clay brick Mz; <math>\rho \geq 1,8</math></b> as per EN 771-1 <i>e.g. Mz Ziegelwerk Nordhausen, DE</i> NF (240x115x71) Hammer drilling	12,5/10,0	1,5	1,5	0,9 / 1,5 <sup>7)</sup>	0,9 / 2,0 <sup>7)</sup>
	15,0/12,0	2,0	2,0	1,2 / 2,0 <sup>7)</sup>	1,2 / 2,0 <sup>7)</sup>
	20,0/16,0	2,5	2,5	1,5 / 2,5 <sup>7)</sup>	1,5 / 3,0 <sup>7)</sup>
	25,0/20,0	3,0	3,5	2,0 / 3,0 <sup>7)</sup>	2,0 / 3,5 <sup>7)</sup>
	35,0/28,0	4,5	5,0	3,0 / 4,5 <sup>7)</sup>	3,0 / 5,0 <sup>7)</sup>
	37,3/-	4,5	5,0	3,0 / 4,5 <sup>7)</sup>	3,0 / 5,5 <sup>7)</sup>
<b>Clay brick Mz; <math>\rho \geq 1,8</math></b> as per EN 771-1 <i>e.g. Mz Ziegelwerk Nordhausen, DE</i> NF (240x115x71) Rotary drilling	10,0/8,0	1,5	2,0	1,5	2,0 / 2,5 <sup>2)</sup>
	12,5/10,0	2,0	2,5	2,0	2,5 / 3,0 <sup>2)</sup> / 3,5 <sup>5)</sup>
	15,0/12,0	2,5	3,0	2,5	3,0 / 4,0 <sup>2)</sup>
	18,5/-	3,0	3,5	3,0	4,0 / 4,5 <sup>2)</sup> / 5,0 <sup>3)</sup>
<b>Calcium silicate solid brick KS; <math>\rho \geq 2,0</math></b> as per EN 771-2 <i>e.g. KS Wemding, DE</i> NF (240x115x71) Hammer drilling	10,0/8,0	1,2 / 1,5 <sup>1)</sup>	1,5	1,5	1,5 / 2,0 <sup>6)</sup>
	12,5/10,0	1,5	2,0	2,0	2,0 / 2,5 <sup>2)</sup>
	15,0/12,0	2,0	2,5	2,5	2,5 / 3,0 <sup>2)</sup>
	20,0/16,0	2,5	3,0 / 3,5 <sup>4)</sup>	3,0 / 3,5 <sup>2)</sup>	3,5 / 4,0 <sup>2)</sup>
	25,0/20,0	3,5	4,0	4,0 / 4,5 <sup>4)</sup>	4,0 / 4,5 <sup>6)</sup> / 5,0 <sup>2)</sup>
	30,0/-	4,0	4,5 / 5,0 <sup>2)</sup>	4,5 / 5,0 <sup>2)</sup>	5,0 / 5,5 <sup>6)</sup> / 6,0 <sup>2)</sup>
<b>Calcium silicate solid brick KS; <math>\rho \geq 1,8</math></b> as per EN 771-2 <i>e.g. KS Wemding, DE</i> 12 DF (498x175x248) Hammer drilling	10,0/8,0	1,5	2,0	2,0	2,0 / 2,5 <sup>6)</sup>
	12,5/10,0	2,0	2,5	2,5	2,5 / 3,0 <sup>6)</sup>
	15,0/12,0	2,5	3,0	3,0	3,0 / 3,5 <sup>6)</sup> / 4,0 <sup>2)</sup>
	20,0/16,0	3,5	3,5	3,5	4,0 / 4,5 <sup>6)</sup> / 5,0 <sup>2)</sup>
	25,0/20,0	4,5	4,5	4,5	5,0 / 6,0 <sup>6)</sup> / 6,5 <sup>2)</sup>
	26,5/-	4,5	5,0	5,0	5,5 / 6,0 <sup>6)</sup> / 6,5 <sup>2)</sup>
Partial factor	$\gamma_{Mm}$ <sup>8)</sup> [-]	2,5			

1) Only valid for temperature range "c" (30/50 °C).

2) Only valid for  $c_{1min}$  120 mm and  $c_{2min}$  180 mm.

3) Only valid for  $c_{1min}$  130 mm and  $c_{2min}$  195 mm.

4) Only valid for  $c_{1min}$  120 mm and  $c_{2min}$  180 mm for temperature range "c" (30/50 °C).

5) Only valid for  $c_{1min}$  130 mm and  $c_{2min}$  195 mm for temperature range "c" (30/50 °C).

6) Only valid for  $c_{1min}$  110 mm and  $c_{2min}$  165 mm.

7) Only valid for  $s_{2,min}$  250 mm.

8) In absence of other national regulations.

9) The compressive strength of the single brick must not be less than 80% of the mean compressive strength.

**fischer frame fixing DuoXpand**

**Performances**

Characteristic resistance for use in solid masonry

**Annex C 9**

Appendix 19 / 25

**Table C10.1: Characteristic resistance  $F_{Rk}$  in [kN] for use in solid and in hollow or perforated masonry - base material group "b" and "c"**

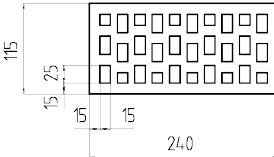
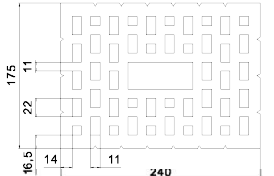
Base material; bulk density [kg/dm <sup>3</sup> ] [Supplier Title, country] Geometry, DF or nominal size (L x W x H) [mm] and drilling method	Mean compressive strength as per EN 771/ Minimum compressive strength single brick <sup>4)</sup> [N/mm <sup>2</sup> ]	Characteristic resistance $F_{Rk}$ [kN] Temperature range 30/50 °C and 50/80 °C			
		DuoXpand 8		DuoXpand 10	
		$h_{nom}$ [mm] <sup>1)</sup>			
		50	70	50	70
<b>Lightweight solid brick Vbl;</b> $\rho \geq 1,4$ as per EN 771-3 e.g. Vbl KLB, DE 2 DF (240x115x113) Rotary drilling	2,5/2,0	0,4	0,6	0,3	0,6 / 0,75 <sup>2)</sup>
	5,0/4,0	0,75 / 0,9 <sup>2)</sup>	1,2	0,6 / 0,75 <sup>2)</sup>	1,2 / 1,5 <sup>2)</sup>
<b>Perforated clay brick Hz;</b> $\rho \geq 0,9$ as per EN 771-1 e.g. Wienerberger Hz, DE 	5,0/4,0	0,5	0,4	0,4	0,4
	7,5/6,0	0,75	0,6	0,6	0,6
	10,0/8,0	0,9	0,75	0,9	0,75
	10,9/-	0,9	0,75	0,9	0,9
	2 DF (240x115x113) Rotary drilling				
<b>Perforated clay brick Hz;</b> $\rho \geq 0,9$ as per EN 771-1 e.g. Schlagmann, DE 	5,0/4,0	0,3	0,5 / 0,6 <sup>2)</sup>	0,3	0,5 / 0,6 <sup>2)</sup>
	7,5/6,0	0,4	0,75 / 0,9 <sup>2)</sup>	0,4 / 0,5 <sup>2)</sup>	0,75 / 0,9 <sup>2)</sup>
	10,0/8,0	0,6	0,9 / 1,2 <sup>2)</sup>	0,6	1,2
	12,5/12,0	0,75	1,2 / 1,5 <sup>2)</sup>	0,75	1,2 / 1,5 <sup>2)</sup>
	15,0/10,0	0,9	1,5	0,9	1,5 / 2,0 <sup>2)</sup>
	3 DF (240x175x113) Rotary drilling	16,2/-	0,9	1,5 / 2,0 <sup>2)</sup>	0,9
<b>Partial factor</b>	$\gamma_{Mm}$ <sup>3)</sup> [-]	<b>2,5</b>			

- 1) The lowest resistance of two consecutive embedment depths may be used for the intermediate embedment depths. Exception for "Lightweight solid brick Vbl": here  $\geq h_{nom}$  is valid.
- 2) Only valid for temperature range "c" (30/50 °C).
- 3) In absence of other national regulations.
- 4) The compressive strength of the single brick must not be less than 80% of the mean compressive strength.

**fischer frame fixing DuoXpand**

**Performances**

Characteristic resistance for use in solid masonry, hollow or perforated masonry

**Annex C 10**

Appendix 20 / 25

**Table C11.1: Characteristic resistance  $F_{Rk}$  in [kN] for use in hollow or perforated masonry - base material group "c"**

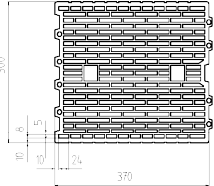
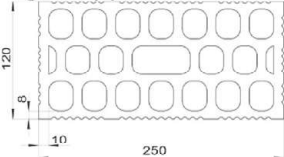
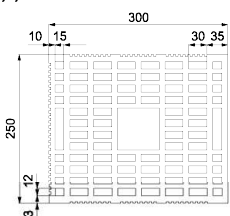
Base material; bulk density [kg/dm <sup>3</sup> ] [Supplier Title, country] Geometry, DF or nominal size (L x W x H) [mm] and drilling method	Mean compressive strength as per EN 771/ Minimum compressive strength single brick <sup>4)</sup> [N/mm <sup>2</sup> ]	Characteristic resistance $F_{Rk}$ [kN] Temperature range 30/50 °C and 50/80 °C			
		DuoXpand 8		DuoXpand 10	
		$h_{nom}$ [mm] <sup>1)</sup>			
		50	70	50	70
<b>Perforated clay brick HLz; <math>\rho \geq 0,7</math></b> as per EN 771-1 e.g. <i>Wienerberger Porotherm 30 R, FR</i> 	7,5/6,0	0,3	0,3	0,3	0,3
	10,0/8,0	0,4	0,4	0,4	0,4
	12,5/10,0	0,5	0,5	0,5	0,5 / 0,6 <sup>2)</sup>
	15,0/12,0	0,6	0,6	0,6	0,6
	17,6/-	0,75	0,75	0,75	0,75
<b>Perforated clay brick HLz; <math>\rho \geq 0,9</math></b> as per EN 771-1 e.g. <i>Doppio Uni IT Wienerberger, IT</i> 	5,0/4,0	0,4	0,4	0,5	0,5
	7,5/6,0	0,6	0,5	0,75	0,75
	10,0/8,0	0,75	0,75	0,9	0,9
	12,5/10,0	0,9	0,9	1,2	1,2
	15,0/12,0	1,2	1,2	1,5	1,5
	18,7/-	1,5	1,2	2,0	2,0
<b>Perforated clay brick HLz; <math>\rho \geq 1,0</math></b> as per EN 771-1 e.g. <i>Wienerberger Pth Bio Modulare, IT</i> 	7,5/6,0	0,75	0,75	0,75	0,75
	10,0/8,0	0,9	0,9	0,9	0,9
	12,5/10,0	1,2	1,2	1,2	1,2
	15,0/12,0	1,5	1,5	1,5	1,5
	20,0/16,0	2,0	2,0	2,0	2,0
	23,6/-	2,5	2,5	2,5	2,5
8 DF (300x250x190) Rotary drilling					
Partial factor	$\gamma_{Mm}^3)$ [-]	2,5			

1) The lowest resistance of two consecutive embedment depths may be used for the intermediate embedment depths.

2) Only valid for temperature range "c" (30/50 °C). 3) In absence of other national regulations.

4) The compressive strength of the single brick must not be less than 80% of the mean compressive strength.

**fischer frame fixing DuoXpand**

**Performances**

Characteristic resistance for use in hollow or perforated masonry

**Annex C 11**

Appendix 21 / 25

**Table C12.1: Characteristic resistance  $F_{Rk}$  in [kN] for use in hollow or perforated masonry - base material group „c“**

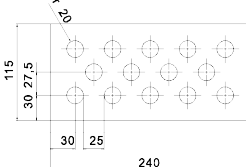
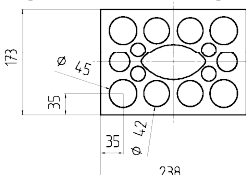
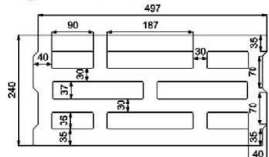
Base material; bulk density [kg/dm <sup>3</sup> ] [Supplier Title, country] Geometry, DF or nominal size (L x W x H) [mm] and drilling method	Mean compressive strength as per EN 771/ Minimum compressive strength single brick <sup>4)</sup> [N/mm <sup>2</sup> ]	Characteristic resistance $F_{Rk}$ [kN] Temperature range 30/50 °C and 50/80 °C			
		DuoXpand 8		DuoXpand 10	
		$h_{nom}$ [mm] <sup>1)</sup>			
		50	70	50	70
<b>Calcium silicate hollow brick KSL;</b> $\rho \geq 1,6$ as per EN 771-2 e.g. Bösel, DE  2 DF ( $\geq 240 \times 115 \times 113$ ) Hammer drilling	10,0/8,0	<b>0,75 / 0,9<sup>2)</sup></b>	<b>0,9</b>	<b>0,9 / 1,2<sup>2)</sup></b>	<b>1,2</b>
	12,5/10,0	<b>0,9 / 1,2<sup>2)</sup></b>	<b>1,2</b>	<b>1,2 / 1,5<sup>2)</sup></b>	<b>1,5</b>
	15,0/12,0	<b>1,2 / 1,5<sup>2)</sup></b>	<b>1,5</b>	<b>1,5</b>	<b>2,0</b>
	20,0/16,0	<b>1,5 / 2,0<sup>2)</sup></b>	<b>2,0</b>	<b>2,0 / 2,5<sup>2)</sup></b>	<b>2,5</b>
	25,0/20,0	<b>2,0</b>	<b>2,5</b>	<b>2,5 / 3,0<sup>2)</sup></b>	<b>3,0</b>
	25,7/-	<b>2,0 / 2,5<sup>2)</sup></b>	<b>2,5</b>	<b>2,5 / 3,0<sup>2)</sup></b>	<b>3,5</b>
<b>Calcium silicate hollow brick KSL;</b> $\rho \geq 1,4$ as per EN 771-2 e.g. KS Wending, DE  3 DF (240x175x113) Hammer drilling	10,0/8,0	<b>0,9</b>	<b>0,75 / 0,9<sup>2)</sup></b>	<b>0,6 / 0,75<sup>2)</sup></b>	<b>0,9 / 1,2<sup>2)</sup></b>
	12,5/10,0	<b>1,2</b>	<b>0,9 / 1,2<sup>2)</sup></b>	<b>0,75 / 0,9<sup>2)</sup></b>	<b>1,2 / 1,5<sup>2)</sup></b>
	15,0/12,0	<b>1,2 / 1,5<sup>2)</sup></b>	<b>1,2 / 1,5<sup>2)</sup></b>	<b>0,9 / 1,2<sup>2)</sup></b>	<b>1,5</b>
	20,0/16,0	<b>1,5 / 2,0<sup>2)</sup></b>	<b>1,5 / 2,0<sup>2)</sup></b>	<b>1,2 / 1,5<sup>2)</sup></b>	<b>2,0</b>
	21,4/-	<b>1,5 / 2,0<sup>2)</sup></b>	<b>1,5 / 2,0<sup>2)</sup></b>	<b>1,2 / 1,5<sup>2)</sup></b>	<b>2,0 / 2,5<sup>2)</sup></b>
<b>Hollow brick lightweight concrete Hbl;</b> $\rho \geq 0,7$ as per EN 771-3 e.g. Knobel, DE  16 DF (495x240x248) Rotary drilling	2,5/2,0	<b>0,5 / 0,6<sup>2)</sup></b>	<b>0,5 / 0,6<sup>2)</sup></b>	<b>0,75</b>	<b>0,75</b>
	5,0/4,0	<b>0,9 / 1,2<sup>2)</sup></b>	<b>0,9 / 1,2<sup>2)</sup></b>	<b>1,5</b>	<b>1,5</b>
Partial factor	$\gamma_{Mm}^{3)}$ [-]	<b>2,5</b>			

1) The lowest resistance of two consecutive embedment depths may be used for the intermediate embedment depths.

2) Only valid for temperature range "c" (30/50 °C). 3) In absence of other national regulations.

4) The compressive strength of the single brick must not be less than 80% of the mean compressive strength.

**fischer frame fixing DuoXpand**

**Performances**

Characteristic resistance for use in hollow or perforated masonry

**Annex C 12**

Appendix 22 / 25

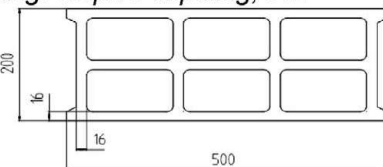
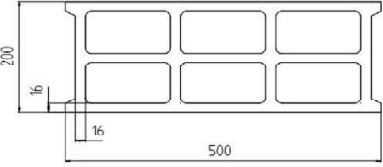

**Table C13.1: Characteristic resistance  $F_{Rk}$  in [kN] for use in hollow or perforated masonry - base material group „c“**

<b>Base material; bulk density [kg/dm<sup>3</sup>]</b> [Supplier Title, country] Geometry, DF or nominal size (L x W x H) [mm] and drilling method	Mean compressive strength as per EN 771/ Minimum compressive strength single brick <sup>5)</sup> [N/mm <sup>2</sup> ]	Characteristic resistance $F_{Rk}$ [kN] Temperature range 30/50 °C and 50/80 °C					
		DuoXpand 8		DuoXpand 10			
		$h_{nom}$ [mm] <sup>1)</sup>					
		50	70	50	70	140	160
<b>Hollow brick lightweight concrete Hbl; <math>\rho \geq 1,0</math></b> as per EN 771-3 e.g. <i>Sepa Parpaing, FR</i> 	2,5/2,0	<b>0,3 / 0,4<sup>2)</sup></b>	<sup>3)</sup>	<b>0,5</b>	<b>0,5</b>	<sup>3)</sup>	<b>0,3</b>
	5,0/4,0	<b>0,75</b>	<b>0,5</b>	<b>0,9</b>	<b>0,9</b>	<b>0,5</b>	<b>0,5</b>
	6,9/-	<b>0,9 / 1,2<sup>2)</sup></b>	<b>0,6</b>	<b>1,5</b>	<b>1,5</b>	<b>0,6</b>	<b>0,75</b>
500x200x200 Rotary drilling							
<b>Hollow brick lightweight concrete Hbl; <math>\rho \geq 1,0</math></b> as per EN 771-3 e.g. <i>Sepa Parpaing, FR</i> 	2,5/2,0	<sup>3)</sup>	<sup>3)</sup>	<sup>3)</sup>	<b>0,3</b>	<sup>3)</sup>	<sup>3)</sup>
	5,0/4,0	<b>0,3</b>	<sup>3)</sup>	<b>0,3 / 0,4<sup>2)</sup></b>	<b>0,6</b>	<sup>3)</sup>	<b>0,3 / 0,4<sup>2)</sup></b>
	6,9/-	<b>0,4 / 0,5<sup>2)</sup></b>	<sup>3)</sup>	<b>0,4 / 0,5<sup>2)</sup></b>	<b>0,75 / 0,9<sup>2)</sup></b>	<sup>3)</sup>	<b>0,4 / 0,6<sup>2)</sup></b>
500x200x200 Hammer drilling							
<b>Partial factor</b>	<b><math>\gamma_{Mm}</math><sup>4)</sup> [-]</b>	<b>2,5</b>					

- 1) The lowest resistance of two consecutive embedment depths may be used for the intermediate embedment depths.
- 2) Only valid for temperature range "c" (30/50 °C).
- 3) No performance assessed.
- 4) In absence of other national regulations.
- 5) The compressive strength of the single brick must not be less than 80% of the mean compressive strength.

fischer frame fixing DuoXpand

**Performances**

Characteristic resistance for use in hollow or perforated masonry

**Annex C 13**

Appendix 23 / 25

**Table C14.1: Characteristic resistance  $F_{Rk}$  in [kN] for use in hollow or perforated masonry - base material group „c“**

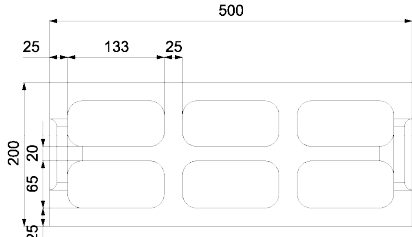
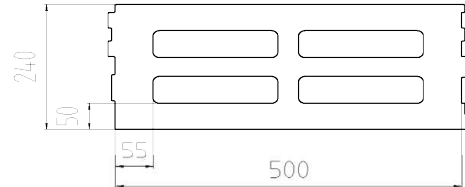
Base material; bulk density [kg/dm <sup>3</sup> ] [Supplier Title, country] Geometry, DF or nominal size (L x W x H) [mm] and drilling method	Mean compressive strength as per EN 771/ Minimum compressive strength single brick <sup>4)</sup> [N/mm <sup>2</sup> ]	Characteristic resistance $F_{Rk}$ [kN] Temperature range 30/50 °C and 50/80 °C			
		DuoXpand 8		DuoXpand 10	
		$h_{nom}$ [mm] <sup>1)</sup>			
		50	70	50	70
<b>Hollow brick lightweight concrete</b> <b>Hbl; <math>\rho \geq 1,0</math></b> as per EN 771-3 e.g. <i>Indelasa, ES</i> 	2,5/2,0	<b>0,6</b>	<b>0,5</b>	<b>0,4</b>	<b>0,6</b>
	4,8/-	<b>1,2</b>	<b>0,9</b>	<b>0,75</b>	<b>0,9 / 1,2<sup>2)</sup></b>
<b>Hollow brick lightweight concrete</b> <b>Hbl; <math>\rho \geq 0,9</math></b> as per EN 771-3 e.g. <i>Knobel, DE</i> 	2,5/2,0	<b>0,9</b>	<b>0,75 / 0,9<sup>2)</sup></b>	<b>0,9</b>	<b>0,6</b>
	5,0/4,0	<b>1,5 / 2,0<sup>2)</sup></b>	<b>1,5 / 2,0<sup>2)</sup></b>	<b>2,0</b>	<b>1,5</b>
	6,2/-	<b>2,0 / 2,5<sup>2)</sup></b>	<b>2,0 / 2,5<sup>2)</sup></b>	<b>2,5</b>	<b>1,5</b>
<b>Partial factor</b>	$\gamma_{Mm}$ <sup>3)</sup> [-]	<b>2,5</b>			

- 1) The lowest resistance of two consecutive embedment depths may be used for the intermediate embedment depths.
- 2) Only valid for temperature range "c" (30/50 °C).
- 3) In absence of other national regulations.
- 4) The compressive strength of the single brick must not be less than 80% of the mean compressive strength.

fischer frame fixing DuoXpand

**Performances**

Characteristic resistance for use in hollow or perforated masonry

**Annex C 14**

Appendix 24 / 25

**Table C15.1: Characteristic resistance  $F_{Rk}$  in [kN] for use in unreinforced autoclaved aerated concrete - base material group „d“**

Base material Size (L x W x H) [mm] and drilling method	Mean compressive strength as per EN 771-4 $f_{cm,decl}$ [N/mm <sup>2</sup> ]	Characteristic resistance $F_{Rk}$ [kN] Temperature range 30/50 °C and 50/80 °C	
		DuoXpand 8	DuoXpand 10
		$h_{nom}$ [mm]	
		≥ 70	
Autoclaved aerated concrete as per EN 771-4 e.g. (500x120x300) e.g. (500x250x300) Hammer drilling	2,8	0,3	0,4 / 0,5 <sup>1)</sup>
	4,0	0,75	0,6
	5,0	0,9 / 1,2 <sup>1)</sup>	0,75
	6,9	1,5 / 2,0 <sup>1)</sup>	0,9
Partial factor	$\gamma_{MAAC}^{2)}$ [-]	2,0	

<sup>1)</sup> Only valid for temperature range "c" (30/50 °C).

<sup>2)</sup> In absence of other national regulations.

**Table C15.2: Characteristic resistance  $F_{Rk}$  in [kN] for use in reinforced autoclaved aerated concrete - base material group „d“**

Base material minimum member thickness $h_{min}$ and drilling method	Compressive strength $f_{ck}$ [N/mm <sup>2</sup> ] (compressive strength class) as per EN 12602	Characteristic resistance $F_{Rk}$ [kN] Temperature range 30/50 °C and 50/80 °C	
		DuoXpand 8	DuoXpand 10
		$h_{nom}$ [mm]	
		≥ 70	
Reinforced autoclaved aerated concrete AAC as per EN 12602 $h_{min} = 100$ mm <sup>3)</sup> Hammer drilling	≥ 2,0 (AAC 2)	2)	0,3 <sup>1)</sup>
	≥ 2,5 (AAC 2,5)	2)	0,3 / 0,4 <sup>1)</sup>
	≥ 3,0 (AAC 3)	2)	0,4
	≥ 3,5 (AAC 3,5)	2)	0,4 / 0,5 <sup>1)</sup>
	≥ 4,0 (AAC 4)	2)	0,5 / 0,6 <sup>1)</sup>
	≥ 4,5 (AAC 4,5)	2)	0,6 / 0,75 <sup>1)</sup>
	≥ 5,0 (AAC 5)	2)	0,75
	≥ 6,0 (AAC 6)	2)	0,9
Partial factor	$\gamma_{MAAC}^{4)}$ [-]	2,0	

<sup>1)</sup> Only valid for temperature range "c" (30/50 °C).

<sup>2)</sup> No performance assessed.

<sup>3)</sup> For anchor groups in AAC 6  $h_{min} = 175$  mm.

<sup>4)</sup> In absence of other national regulations.

**fischer frame fixing DuoXpand**

**Performances**

Characteristic resistance for use in autoclaved aerated concrete and in reinforced autoclaved aerated concrete

**Annex C 15**

Appendix 25 / 25