



PRESTANDEKLARATION



Nr 0064 – SV

1. Produkttypens unika identifikationskod: **Injektionssystem UPM 33**

2. Avsedd användning/avsedda användningar:

Produkt	Avsedd användning/användningar
Kemiskt ankare för användning i betong	Förankringar som uppfyller kraven på mekanisk hållfasthet och stabilitet samt användningssäkerhet. De används till fastsättning och/eller förankring av bärverksdelar (som bidrar till systemens stabilitet) eller tunga element, se bilaga, särskilt bilagor B 1 - B 6

3. Tillverkare: **fischerwerke GmbH & Co. KG, Otto-Hahn-Straße 15, 79211 Denzlingen, Tyskland**

4. Tillverkarens representant: --

5. System för bedömning och fortlöpande kontroll av prestanda: **1**

6a. Harmoniserad standard: ---

Anmält/anmälda organ: ---

6b. Europeiskt bedömningsdokument: **ETAG 001; 2013-04**

Europeisk teknisk bedömning: **ETA-10/0171; 2015-08-27**

Tekniskt bedömningsorgan: **DIBt**

Anmält/anmälda organ: **1343 – MPA Darmstadt**

7. Angiven prestanda:

**Mekanisk hållfasthet och stabilitet (BWR 1)**

Väsentlig egenskap	Prestanda
Karaktäristiskt motstånd för konstruktion enligt TR 029	Se bilaga, särskilt bilagor C 1 - C 3
Karaktäristiska motstånd för design enligt CEN / TS 1992-4: 2009	Se bilaga, särskilt bilagor C 4 - C 6
Förskjutningar under spänning och tvärlaster	Se bilaga, särskilt bilaga C 7

**Säkerhet vid brand (BWR 2)**

Väsentlig egenskap	Prestanda
Reaktion vid brand	Pluggen uppfyller kraven i klass A1
Motståndskraft mot eld	NPD

8. Lämplig teknisk dokumentation och/eller särskild teknisk dokumentation: ---

Prestandan för ovanstående produkt överensstämmer med den angivna prestandan. Denna prestandadeklaration har utfärdats i enlighet med förordning (EU) nr 305/2011 på eget ansvar av den tillverkare som anges ovan.

Undertecknad på tillverkarens vägnar av:

Andreas Bucher, Dipl.-Ing.

Wolfgang Hengesbach, Dipl.-Ing., Dipl.-Wirtsch.-Ing.

Tumlingen, 2015-09-03

- Denna DoP har förberetts på olika språk. I händelse av tvist om tolkningen ska den engelska versionen alltid råda.

- Bilagan innehåller frivilliga och kompletterande information på engelska som överskrider (språk neutralt specificerade) lagkrav.

**Specific Part**

**1 Technical description of the product**

The Injection system UPM 33 is a bonded anchor consisting of a cartridge with injection mortar UPM 33 and a steel element. The steel element consist of

- an Upat threaded rod or of sizes M6 to M30 or
- an Upat internal threaded anchor IST of sizes M8 to M20 or

The steel element is placed into a drilled hole filled with injection mortar and is anchored via the bond between metal part, injection mortar and concrete.

The product description is given in Annex A.

**2 Specification of the intended use in accordance with the applicable European Assessment Document**

The performances given in Section 3 are only valid if the anchor is used in compliance with the specifications and conditions given in Annex B.

The verifications and assessment methods on which this European Technical Assessment is based lead to the assumption of a working life of the anchor of at least 50 years. The indications given on the working life cannot be interpreted as a guarantee given by the producer, but are to be regarded only as a means for choosing the right products in relation to the expected economically reasonable working life of the works.

**3 Performance of the product and references to the methods used for its assessment**

**3.1 Mechanical resistance and stability (BWR 1)**

Essential characteristic	Performance
Characteristic resistance for design according to TR 029	See Annex C 1 to C 3
Characteristic resistance for design according to CEN/TS 1992-4:2009	See Annex C 4 to C 6
Displacements under tension and shear loads	See Annex C 7

**3.2 Safety in case of fire (BWR 2)**

Essential characteristic	Performance
Reaction to fire	Anchorage satisfy requirements for Class A1
Resistance to fire	No performance assessed

**3.3 Hygiene, health and the environment (BWR 3)**

Regarding dangerous substances there may be requirements (e.g. transposed European legislation and national laws, regulations and administrative provisions) applicable to the products falling within the scope of this European Technical Assessment. In order to meet the provisions of Regulation (EU) No 305/2011, these requirements need also to be complied with, when and where they apply.

**3.4 Safety in use (BWR 4)**

The essential characteristics regarding Safety in use are included under the Basic Works Requirement Mechanical resistance and stability.

**4 Assessment and verification of constancy of performance (AVCP) system applied, with reference to its legal base**

In accordance with guideline for European technical approval ETAG 001, April 2013, used as European Assessment Document (EAD) according to Article 66 Paragraph 3 of Regulation (EU) No 305/2011, the applicable European legal act is: [96/582/EC].

The system to be applied is: 1

**Installation condition**

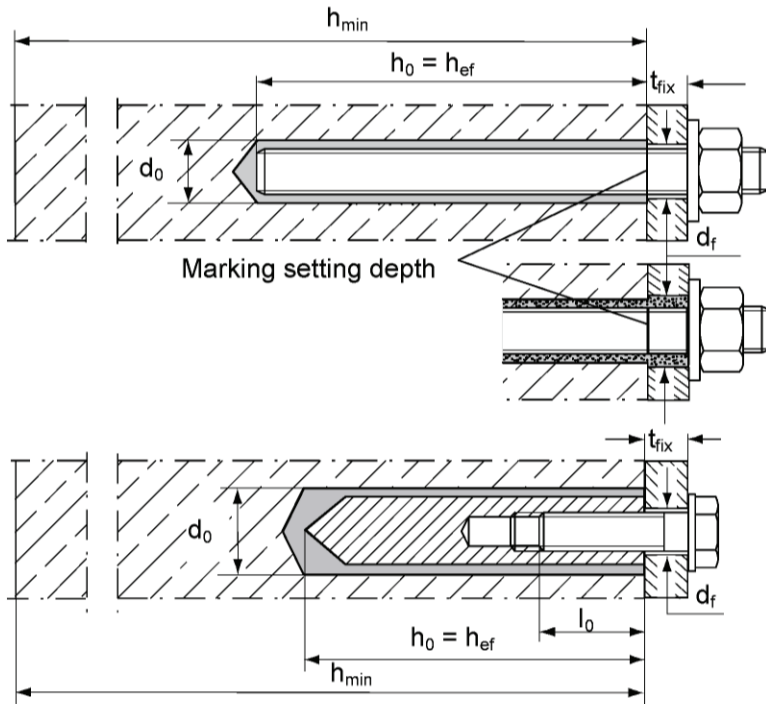

**Upat threaded rod** pre-positioned anchorage

**Upat threaded rod** push through anchorage (annular gap filled with mortar)

**Upat internal threaded anchor IST** only pre-positioned anchorage

**Injection system UPM 33**

**Product description**  
Installation condition

**Annex A 1**

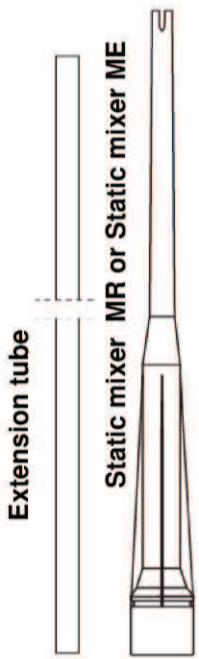

**Shuttle cartridge**

(Sizes: 345 ml; 360 ml; 390 ml; 950 ml; 1100ml; 1500 ml)

Sealing cap

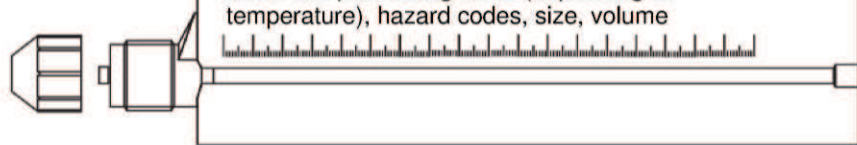

Imprint: UPM 33, UPM 33 Express or UPM 33 Relax, processing notes, shelf-life, piston travel scale, curing times and processing times (depending on temperature), hazard codes, size, volume

**Coaxial cartridge**

(Sizes: 100 ml; 150 ml; 300 ml; 380 ml; 400ml; 410 ml)

Sealing cap

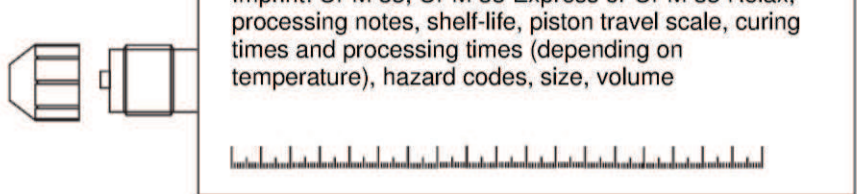

Imprint: UPM 33, UPM 33 Express or UPM 33 Relax, processing notes, shelf-life, piston travel scale, curing times and processing times (depending on temperature), hazard codes, size, volume

**Upat threaded rod**

Sizes: M6, M8, M10, M12, M16, M20, M24, M27, M30



Washer

Hexagon nut



**Upat internal threaded anchor IST**

Sizes: M8, M10, M12, M16, M20

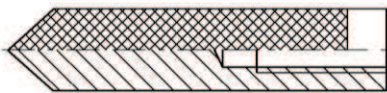

Screw

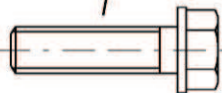

Threaded rod

Washer

Hexagon nut



**Injection system UPM 33**

**Product description**

Cartridges / Static mixer / Steel elements

**Annex A 2**

Table A1: Materials

Part	Designation	Material		
1	Mortar cartridge	Mortar, hardener; filler		
		Steel, zinc plated	Stainless steel A4	High corrosion-resistant steel C
2	Threaded rod	Property class 5.8 or 8.8; EN ISO 898-1: 2013 zinc plated $\geq 5\mu\text{m}$ , EN ISO 4042:1999 A2K or hot-dip galvanised EN ISO 10684:2004 $f_{uk} \leq 1000 \text{ N/mm}^2$ $A_5 > 8\%$ fracture elongation	Property class 50, 70 or 80 EN ISO 3506:2009 1.4401; 1.4404; 1.4578; 1.4571; 1.4439; 1.4362; 1.4062 EN 10088-1:2014 $f_{uk} \leq 1000 \text{ N/mm}^2$ $A_5 > 8\%$ fracture elongation	Property class 50 or 80 EN ISO 3506:2009 or property class 70 with $f_{yk} = 560 \text{ N/mm}^2$ 1.4565; 1.4529 EN 10088-1:2014 $f_{uk} \leq 1000 \text{ N/mm}^2$ $A_5 > 8\%$ fracture elongation
3	Washer ISO 7089:2000	zinc plated $\geq 5\mu\text{m}$ , EN ISO 4042:1999 A2K or hot-dip galvanised EN ISO 10684:2004	1.4401; 1.4404; 1.4578; 1.4571; 1.4439; 1.4362 EN 10088-1:2014	1.4565; 1.4529 EN 10088-1:2014
4	Hexagon nut	Property class 5 or 8; EN ISO 898-2:2013 zinc plated $\geq 5\mu\text{m}$ , ISO 4042:1999 A2K or hot-dip galvanised ISO 10684:2004	Property class 50, 70 or 80 EN ISO 3506:2009 1.4401; 1.4404; 1.4578; 1.4571; 1.4439; 1.4362 EN 10088-1:2014	Property class 50, 70 or 80 EN ISO 3506:2009 1.4565; 1.4529 EN 10088-1:2014
5	Internal threaded anchor IST	Property class 5.8; EN 10277-1:2008-06 zinc plated $\geq 5\mu\text{m}$ , ISO 4042:1999 A2K	Property class 70 EN ISO 3506:2009 1.4401; 1.4404; 1.4578; 1.4571; 1.4439; 1.4362 EN 10088-1:2014	Property class 70 EN ISO 3506-1:2009 1.4565; 1.4529 EN 10088-1:2014
6	Screw or threaded rod for internal threaded anchor IST	Property class 5.8 or 8.8; EN ISO 898-1:2013 zinc plated $\geq 5\mu\text{m}$ , ISO 4042:1999 A2K	Property class 70 EN ISO 3506:2009 1.4401; 1.4404; 1.4578; 1.4571; 1.4439; 1.4362 EN 10088-1:2014	Property class 70 EN ISO 3506-1:2009 1.4565; 1.4529 EN 10088-1:2014



Injection system UPM 33

Product description  
Materials

Annex A 3

**Specifications of intended use**

**Table B1: Overview use categories and performance categories**

Anchorages subject to		UPM 33 with ...			
		Threaded rod 	Internal threaded anchor IST 		
Hammer drilling		all sizes			
Static and quasi static load, in	un-cracked concrete	M6 to M30	Tables: C1, C3, C5, C7, C9, C10	M8 to M20	Tables: C2, C4, C6, C8, C11, C12
	cracked concrete	M10 to M20		-	
Use category	Dry or wet concrete	M6 to M30		M8 to M20	
Installation temperature		-10°C to +40°C			
In-service temperature	Temperature range I	-40°C to +80°C		(max. long term temperature +50°C and max. short term temperature +80°C)	
	Temperature range II	-40°C to +120°C		(max. long term temperature +72°C and max. short term temperature +120°C)	

**Base materials:**

- Reinforced or unreinforced normal weight concrete according to EN 206:2013
- Strength classes C20/25 to C50/60 according to EN 206:2013

**Use conditions (Environmental conditions):**

- Structures subject to dry internal conditions exist (zinc coated steel, stainless steel or high corrosion resistant steel)
- Structures subject to external atmospheric exposure (including industrial and marine environment) and to permanently damp internal condition, if no particular aggressive conditions exist (stainless steel or high corrosion resistant steel)
- Structures subject to external atmospheric exposure and to permanently damp internal condition, if other particular aggressive conditions exist (high corrosion resistant steel)  
Note: Particular aggressive conditions are e.g. permanent, alternating immersion in seawater or the splash zone of seawater, chloride atmosphere of indoor swimming pools or atmosphere with extreme chemical pollution (e. g. in desulphurization plants or road tunnels where de-icing materials are used)

**Design:**

- Anchorages have to be designed under the responsibility of an engineer experienced in anchorages and concrete work
- Verifiable calculation notes and drawings are prepared taking account of the loads to be anchored. The position of the anchor is indicated on the design drawings (e.g. position of the anchor relative to reinforcement or to supports, etc.)
- Anchorages under static or quasi-static actions are designed in accordance with TR 029 "Design of bonded anchors", Edition September 2010 or CEN/TS 1992-4:2009

**Installation:**

- Anchor installation carried out by appropriately qualified personnel and under the supervision of the person responsible for technical matters of the site
- Overhead installation allowed

<b>Injection system UPM 33</b>	<b>Annex B 1</b>
<b>Intended Use Specifications</b>	

**Table B2: Installation parameters threaded rods**

Size			M6	M8	M10	M12	M16	M20	M24	M27	M30	
Width across flat	SW	[mm]	10	13	17	19	24	30	36	41	46	
Nominal drill bit diameter	$d_0$	[mm]	8	10	12	14	18	24	28	30	35	
Drill hole depth	$h_0$	[mm]	$h_0 = h_{ef}$									
Effective anchorage depth	$h_{ef,min}$	[mm]	50	60	60	70	80	90	96	108	120	
	$h_{ef,max}$	[mm]	72	160	200	240	320	400	480	540	600	
Maximum torque moment	$T_{inst,max}$	[Nm]	5	10	20	40	60	120	150	200	300	
Minimum spacing	$s_{min}$	[mm]	40	40	45	55	65	85	105	125	140	
Minimum edge distance	$c_{min}$	[mm]	40	40	45	55	65	85	105	125	140	
Diameter of clearance hole in the fixture <sup>1)</sup>	Pre-positioned anchorage	$d_f$	[mm]	7	9	12	14	18	22	26	30	33
	Push through anchorage	$d_f$	[mm]	9	11	14	16	20	26	30	32	40
Minimum thickness of concrete member	$h_{min}$	[mm]	$h_{ef} + 30 (\geq 100)$				$h_{ef} + 2d_0$					

<sup>1)</sup> For larger clearance holes in the fixture see TR 029, 4.2.2.1 or CEN/TS 1992-4-1:2009, 5.2.3.1

**Upat threaded rods**

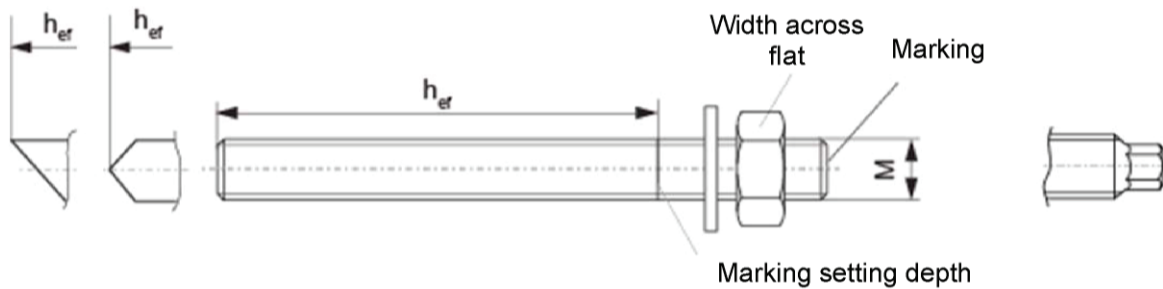

**Marking:**

- Property class 8.8 or high corrosion-resistant steel C, property class 80: •
- Stainless steel A4, property class 50 or high corrosion-resistant steel C, property class 50:••

**Commercial standard threaded rods, washers and hexagon nuts may also be used if the following requirements are fulfilled:**

- Materials, dimensions and mechanical properties according Annex A 3, Table A1
- Inspection certificate 3.1 according to EN 10204:2004, the documents should be stored
- Marking of embedment depth

**Injection system UPM 33**

**Intended Use**  
Installation parameters threaded rods

**Annex B 2**

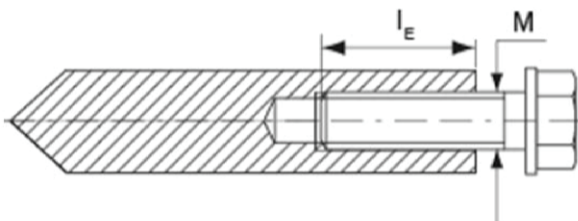

**Table B3: Installation parameters internal threaded anchors IST**

Size		M8	M10	M12	M16	M20
Diameter of anchor	$d_H$ [mm]	12	16	18	22	28
Nominal drill bit diameter	$d_0$ [mm]	14	18	20	24	32
Drill hole depth	$h_0$ [mm]	$h_0 = h_{ef}$				
Effective anchorage depth ( $h_{ef} = L_H$ )	$h_{ef}$ [mm]	90	90	125	160	200
Maximum torque moment	$T_{inst,max}$ [Nm]	10	20	40	80	120
Minimum spacing	$s_{min}$ [mm]	55	65	75	95	125
Minimum edge distance	$c_{min}$ [mm]	55	65	75	95	125
Diameter of clearance hole in the fixture <sup>1)</sup>	$d_f$ [mm]	9	12	14	18	22
Minimum thickness of concrete member	$h_{min}$ [mm]	120	125	165	210	265
Maximum screw-in depth	$l_{E,max}$ [mm]	18	23	26	35	45
Minimum screw-in depth	$l_{E,min}$ [mm]	8	10	12	16	20

<sup>1)</sup> For larger clearance holes in the fixture see TR 029, 4.2.2.1 or CEN/TS 1992-4-1:2009, 5.2.3.1

**Upat internal threaded anchor IST**



Marking

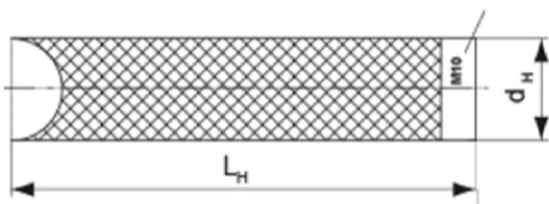

Marking: anchor size e.g.: M10  
Stainless steel in addition A4 e.g.: M10 A4  
High corrosion-resistant steel in addition C e.g.: M10 C

Fastening screw or threaded rods including washer and nuts must comply with the appropriate material and strength class of table A1

**Injection system UPM 33**

**Intended Use**

Installation parameters internal threaded anchors IST

**Annex B 3**

**Table B4: Parameters of steel brush Upat BS Ø**

Drill bit diameter	[mm]	8	10	12	14	16	18	20	24	25	28	30	35
Steel brush diameter $d_b$	[mm]	9	11	14	16	20	20	25	26	27	30	40	40

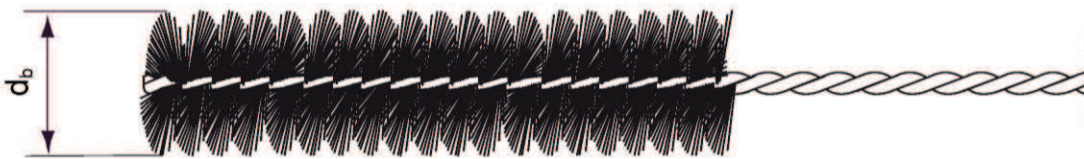

**Table B5: Maximum processing time of the mortar and minimum curing time**  
(During the curing time of the mortar the concrete temperature may not fall below the listed minimum temperature).

Temperature at anchoring base [ °C ]			Minimum curing time <sup>1)</sup> $t_{cure}$ [ minutes ]			System temperature (mortar) [ °C ]	Maximum processing time $t_{work}$ [ minutes ]		
			UPM 33 Express	UPM 33	UPM 33 Relax		UPM 33 Express	UPM 33	UPM 33 Relax
-10	to	-5	12 hours						
>-5	to	±0	3 hours	24 hours		±0	5		
>±0	to	+5	3 hours	3 hours	6 hours	+5	5	13	
>+5	to	+10	50	90	3 hours	+10	3	9	20
>+10	to	+20	30	60	2 hours	+20	1	5	10
>+20	to	+30		45	60	+30		4	6
>+30	to	+40		35	30	+40		2	4



<sup>1)</sup> For wet concrete the curing time must be doubled.

<b>Injection system UPM 33</b>	<b>Annex B 4</b>
<b>Intended Use</b> Cleaning tools / Processing - and curing times	

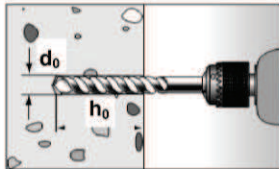
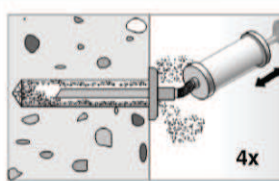
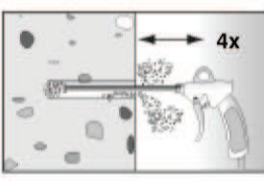
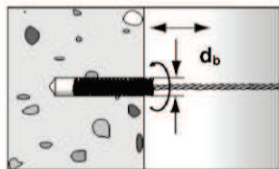
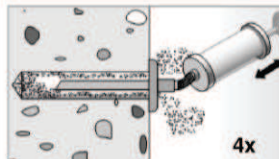
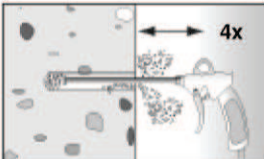
**Installation instructions part 1**  
**Drilling and cleaning the hole**

1		<p>Drill the hole. Drill hole diameter <math>d_0</math> and drill hole depth <math>h_0</math> see Tables <b>B2</b>, <b>B3</b>.</p>	
2		<p><math>h_{ef} \leq 12d</math> and <math>d_0 &lt; 18</math> mm: Blow out the drill hole four times by hand.</p>	 <p><math>h_{ef} &gt; 12d</math> and/or <math>d_0 \geq 18</math> mm: Blow out the drill hole four times, using oil-free compressed air (<math>p &gt; 6</math> bar).</p>
3		<p>Brush the drill hole four times using an adequate steel brush (see Table <b>B4</b>).</p>	
4		<p><math>h_{ef} \leq 12d</math> and <math>d_0 &lt; 18</math> mm: Blow out the drill hole four times by hand.</p>	 <p><math>h_{ef} &gt; 12d</math> and/or <math>d_0 \geq 18</math> mm: Blow out the drill hole four times, using oil-free compressed air (<math>p &gt; 6</math> bar).</p>

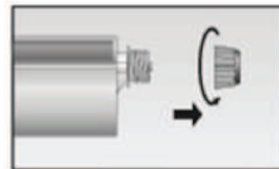
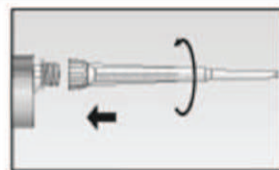
**Preparing the cartridge**

5		<p>Twist off the sealing cap.</p>	
6		<p>Twist on the static mixer (the spiral in the static mixer must be clearly visible).</p>	
7		<p>Place the cartridge into the suitable dispenser.</p>	
8		<p>Press out approximately 10 cm of mortar until the resin is permanently grey in colour. mortar which is not grey in colour will not cure and must be disposed of.</p>	

<p><b>Injection system UPM 33</b></p>	<p><b>Annex B 5</b></p>
<p><b>Intended Use</b> Installation instructions part 1</p>	

**Installation instructions part 2**

**Injection of the mortar**

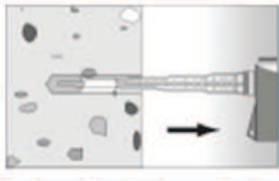
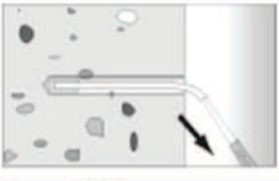
9		<p>Fill approximately 2/3 of the drill hole with mortar. Always begin from the bottom of the hole to eliminate voids.</p>		<p>For drill hole depth <math>\geq 150</math> mm use an extension tube.</p>
---	---	---	--	---

**Installation Upat threaded rods or internal threaded anchors IST**

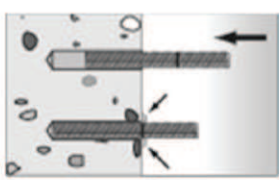
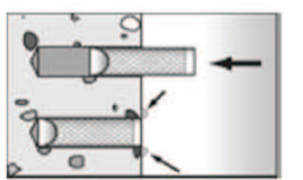
10			<p>Only use clean and oil-free anchor elements. Press the anchor rod or internal threaded anchor IST down to the bottom of the hole, turning it slightly while doing so. After inserting the anchor element, excess mortar must emerge around the anchor element.</p>
----	---	---	---

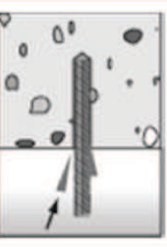
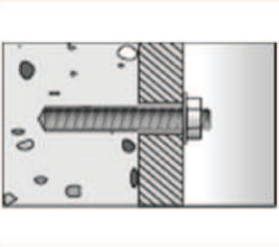
	<p>For overhead installation support the anchor element with wedges.</p>		<p>For push-through installation fill the annular gap also with mortar.</p>
--	--	---	---

11		<p>Wait for the specified curing time <math>t_{cure}</math> see Table B5.</p>
----	---	---

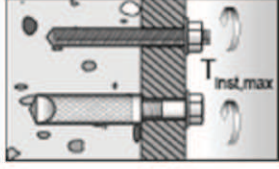
12		<p>Mounting the fixture  <math>T_{inst,max}</math> see Tables B2 or B3</p>
----	---	--

**Injection system UPM 33**

**Intended Use**  
 Installation instructions part 2

**Annex B 6**

**Table C1: Characteristic values of resistance for threaded rods under tension loads in un-cracked and cracked concrete (Design according to TR 029)**

Size			M6	M8	M10	M12	M16	M20	M24	M27	M30
Installation safety factor	Dry and wet concrete	$\gamma_2$	[-]		1,2						
<b>Combined pullout and concrete cone failure</b>											
Diameter of calculation	d	[mm]	6	8	10	12	16	20	24	27	30
<b>Characteristic bond resistance in un-cracked concrete C20/25. Dry and wet concrete</b>											
Temperature range I <sup>1)</sup>	$\tau_{Rk,ucr}$	[N/mm <sup>2</sup> ]	9,0	11,0	11,0	11,0	10,0	9,5	9,0	8,5	8,5
Temperature range II <sup>1)</sup>	$\tau_{Rk,ucr}$	[N/mm <sup>2</sup> ]	6,5	9,5	9,5	9,0	8,5	8,0	7,5	7,0	7,0
<b>Characteristic bond resistance in cracked concrete C20/25. Dry and wet concrete</b>											
Temperature range I <sup>1)</sup>	$\tau_{Rk,cr}$	[N/mm <sup>2</sup> ]	--	--	6,0	6,0	6,0	5,5	--	--	--
Temperature range II <sup>1)</sup>	$\tau_{Rk,cr}$	[N/mm <sup>2</sup> ]	--	--	5,0	5,0	5,0	5,0	--	--	--
Increasing factor $\psi_c$	C25/30	[-]					1,05				
	C30/37	[-]					1,10				
	C35/45	[-]					1,15				
	C40/50	[-]					1,19				
	C45/55	[-]					1,22				
	C50/60	[-]					1,26				
<b>Splitting failure</b>											
Edge distance $c_{cr,sp}$	$h/h_{ef} \geq 2,0$	[mm]					1,0 $h_{ef}$				
	$2,0 > h/h_{ef} > 1,3$	[mm]					4,6 $h_{ef} - 1,8 h$				
	$h/h_{ef} \leq 1,3$	[mm]					2,26 $h_{ef}$				
Spacing	$s_{cr,sp}$	[mm]					2 $c_{cr,sp}$				

<sup>1)</sup> See Annex B1

**Injection system UPM 33**

**Performances**

Characteristic values of resistance for threaded rods under tension loads in un-cracked and cracked concrete (Design according to TR 029)

**Annex C 1**

**Table C2: Characteristic values of resistance for internal threaded anchors IST under tension loads in un-cracked concrete (Design according to TR 029)**

Size				M8	M10	M12	M16	M20
Installation safety factor	Dry and wet concrete	$\gamma_2$	[-]	1,2				
<b>Steel failure</b>								
Characteristic resistance with screw $N_{Rk,s}$	Property class	5.8	[kN]	19	29	43	79	123
		8.8	[kN]	29	47	68	108	179
	Property class 70	A4	[kN]	26	41	59	110	172
		C	[kN]	26	41	59	110	172
<b>Combined pullout and concrete cone failure</b>								
Diameter of calculation		$d_H$	[mm]	12	16	18	22	28
<b>Characteristic bond resistance in un-cracked concrete C20/25. Dry and wet concrete</b>								
Temperature range I <sup>1)</sup>		$N_{Rk,p}^0$	[kN]	30	40	50	75	115
Temperature range II <sup>1)</sup>		$N_{Rk,p}^0$	[kN]	25	30	40	60	95
Increasing factor $\Psi_c$	C25/30		[-]	1,05				
	C30/37		[-]	1,10				
	C35/45		[-]	1,15				
	C40/50		[-]	1,19				
	C45/55		[-]	1,22				
	C50/60		[-]	1,26				
<b>Splitting failure</b>								
Edge distance $c_{cr,sp}$	$h/h_{ef} \geq 2,0$		[mm]	$1,0 h_{ef}$				
	$2,0 > h/h_{ef} > 1,3$		[mm]	$4,6 h_{ef} - 1,8 h$				
	$h/h_{ef} \leq 1,3$		[mm]	$2,26 h_{ef}$				
Spacing		$s_{cr,sp}$	[mm]	$2 c_{cr,sp}$				

<sup>1)</sup> See Annex B1

**Table C3: Characteristic values of resistance for threaded rods under shear loads (Design according to TR 029)**

Size				M6	M8	M10	M12	M16	M20	M24	M27	M30
<b>Concrete pryout failure</b>												
Factor k in equation (5.7) of TR 029 for the design of bonded anchors		k	[-]	2,0								

**Injection system UPM 33**

**Performances**

Characteristic values of resistance for internal threaded rods under tension loads in un-cracked concrete and for threaded rods under shear loads (Design according to TR 029)

**Annex C 2**

**Table C4: Characteristic values of resistance for internal threaded rods IST under shear loads (Design according to TR 029)**

Size				<b>M8</b>	<b>M10</b>	<b>M12</b>	<b>M16</b>	<b>M20</b>
Installation safety factor	$\gamma_2$	[-]		1,2				
<b>Steel failure without lever arm</b>								
Characteristic resistance $V_{Rk,s}$	Property class	5.8	[kN]	9,2	14,5	21,1	39,2	62,0
		8.8	[kN]	14,6	23,2	33,7	62,7	90,0
	Property class 70	A4	[kN]	12,8	20,3	29,5	54,8	86,0
		C	[kN]	12,8	20,3	29,5	54,8	86,0
<b>Steel failure with lever arm</b>								
Characteristic resistance $M_{Rk,s}^0$	Property class	5.8	[Nm]	20	39	68	173	337
		8.8	[Nm]	30	60	105	266	519
	Property class 70	A4	[Nm]	26	52	92	232	454
		C	[Nm]	26	52	92	232	454
<b>Concrete pryout failure</b>								
Factor k in equation (5.7) of TR 029 for the design of bonded anchors	k	[-]		2,0				

**Injection system UPM 33****Performances**

Characteristic values of resistance for internal threaded anchors IST under shear loads (Design according to TR 029)

**Annex C 3**

**Table C5: Characteristic values of resistance for threaded rods under tension loads in un-cracked and cracked concrete (Design according to CEN/TS 1992-4)**

Size			M6	M8	M10	M12	M16	M20	M24	M27	M30
Installation safety factor $\gamma_{inst}$	Dry and wet concrete	[-]	1,2								
<b>Steel failure</b>											
Characteristic resistance	$N_{Rk,s}$	[kN]	$A_s \times f_{uk}$								
<b>Combined pullout and concrete cone failure</b>											
Diameter of calculation	d	[mm]	6	8	10	12	16	20	24	27	30
<b>Characteristic bond resistance in un-cracked concrete C20/25. Dry and wet concrete</b>											
Temperature range I <sup>1)</sup>	$\tau_{Rk,ucr}$	[N/mm <sup>2</sup> ]	9,0	11,0	11,0	11,0	10,0	9,5	9,0	8,5	8,5
Temperature range II <sup>1)</sup>	$\tau_{Rk,ucr}$	[N/mm <sup>2</sup> ]	6,5	9,5	9,5	9,0	8,5	8,0	7,5	7,0	7,0
<b>Characteristic bond resistance in cracked concrete C20/25. Dry and wet concrete</b>											
Temperature range I <sup>1)</sup>	$\tau_{Rk,cr}$	[N/mm <sup>2</sup> ]	--	--	6,0	6,0	6,0	5,5	--	--	--
Temperature range II <sup>1)</sup>	$\tau_{Rk,cr}$	[N/mm <sup>2</sup> ]	--	--	5,0	5,0	5,0	5,0	--	--	--
Increasing factor $\Psi_c$	C25/30	[-]	1,05								
	C30/37	[-]	1,10								
	C35/45	[-]	1,15								
	C40/50	[-]	1,19								
	C45/55	[-]	1,22								
	C50/60	[-]	1,26								
Factor acc. CEN/TS 1992-4:2009 Section 6.2.2.3	$k_8$	cracked concrete	[-]	7,2							
	$k_8$	un-cracked concrete	[-]	10,1							
<b>Concrete cone failure</b>											
Factor acc. CEN/TS 1992-4:2009 Section 6.2.3.1	$k_{cr}$	cracked concrete	[-]	7,2							
	$k_{ucr}$	un-cracked concrete	[-]	10,1							
Edge distance $c_{cr,sp}$	$h/h_{ef} \geq 2,0$	[mm]	$1,0 h_{ef}$								
	$2,0 > h/h_{ef} > 1,3$	[mm]	$4,6 h_{ef} - 1,8 h$								
	$h/h_{ef} \leq 1,3$	[mm]	$2,26 h_{ef}$								
Spacing	$s_{cr,sp}$	[mm]	$2 c_{cr,sp}$								

<sup>1)</sup> See Annex B1

### Injection system UPM 33

#### Performances

Characteristic values of resistance for threaded rods under tension loads in un-cracked and cracked concrete (Design according to CEN/TS-1992-4)

**Annex C 4**



**Table C6: Characteristic values of resistance for internal threaded anchors IST under tension loads in un-cracked concrete (Design according to CEN/TS 1992-4)**

Size				M8	M10	M12	M16	M20
Installation safety factor	Dry and wet concrete		[-]	1,2				
$\gamma_{inst}$								
<b>Steel failure</b>								
Characteristic resistance with screw $N_{Rk,s}$	Property class	5.8	[kN]	19	29	43	79	123
		8.8	[kN]	29	47	68	108	179
	Property class 70	A4	[kN]	26	41	59	110	172
		C	[kN]	26	41	59	110	172
Partial safety factor $\gamma_{Ms,N}^{2)}$	Property class	5.8	[-]	1,50				
		8.8	[-]	1,50				
	Property class 70	A4	[-]	1,87				
		C	[-]	1,87				
<b>Combined pullout and concrete cone failure</b>								
Diameter of calculation	d	[mm]		12	16	18	22	28
<b>Characteristic bond resistance in un-cracked concrete C20/25</b>								
<b>Dry and wet concrete</b>								
Temperature range I <sup>1)</sup>		$N_{Rk,p}^0$	[kN]	30	40	50	75	115
Temperature range II <sup>1)</sup>		$N_{Rk,p}^0$	[kN]	25	30	40	60	95
Increasing factor $\Psi_c$		C25/30	[-]	1,05				
		C30/37	[-]	1,10				
		C35/45	[-]	1,15				
		C40/50	[-]	1,19				
		C45/55	[-]	1,22				
		C50/60	[-]	1,26				
Factor acc. CEN/TS 1992-4-5:2009 Section 6.2.2.3	$k_B$	[-]		10,1				
<b>Concrete cone failure</b>								
Factor acc. CEN/TS 1992-4-5:2009 Section 6.2.3.1	$k_{ucr}$	[-]		10,1				
Edge distance $c_{cr,sp}$		$h/h_{ef} \geq 2,0$	[mm]	$1,0 h_{ef}$				
		$2,0 > h/h_{ef} > 1,3$	[mm]	$4,6 h_{ef} - 1,8 h$				
		$h/h_{ef} \leq 1,3$	[mm]	$2,26 h_{ef}$				
Spacing	$s_{cr,sp}$	[mm]		$2 c_{cr,sp}$				

<sup>1)</sup> See Annex B1

<sup>2)</sup> In absence of other national regulations

**Injection system UPM 33**

**Performances**

Characteristic values of resistance for internal threaded anchors IST under tension loads in un-cracked concrete (Design according to CEN/TS 1992-4)

**Annex C 5**

**Table C7: Characteristic values of resistance for threaded rods under shear loads (Design according to CEN/TS 1992-4)**

Size	M6	M8	M10	M12	M16	M20	M24	M27	M30
Installation safety factor $\gamma_{inst}$ [-]	1,2								
<b>Steel failure without lever arm</b>									
Characteristic resistance $V_{Rk,s}$ [kN]	0,5 $A_s \times f_{uk}$								
Ductility factor acc. to CEN/TS 1992-4-5:2009 Section 6.3.2.1 $k_2$ [-]	0,8								
<b>Steel failure with lever arm</b>									
Characteristic resistance $M^0_{Rk,s}$ [Nm]	1,2 $\times W_{el} \times f_{uk}$								
<b>Concrete pryout failure</b>									
Factor in equation of CEN/TS 1992-4-5:2009 Section 6.3.3 $k_3$ [-]	2,0								
<b>Concrete edge failure</b>									
Effective length of anchor $l_f$ [mm]	$l_f = \min (h_{ef}, 8 d_{nom})$								
Outside diameter of anchor $d_{nom}$ [mm]	6	8	10	12	16	20	24	27	30

**Table C8: Characteristic values of resistance for internal threaded rods IST under shear loads in uncracked concrete (Design according to CEN/TS 1992-4)**

Size	M8	M10	M12	M16	M20	
Installation safety factor $\gamma_{inst}$ [-]	1,2					
<b>Steel failure without lever arm</b>						
Characteristic resistance $V_{Rk,s}$	Property class 5.8 [kN]	9,2	14,5	21,1	39,2	62,0
	Property class 8.8 [kN]	14,6	23,2	33,7	62,7	90,0
	Property class A4 [kN]	12,8	20,3	29,5	54,8	86,0
	Property class 70 C [kN]	12,8	20,3	29,5	54,8	86,0
Ductility factor acc. to CEN/TS 1992-4-5:2009 Section 6.3.2.1 $k_2$ [-]	0,8					
<b>Steel failure with lever arm</b>						
Characteristic resistance $M^0_{Rk,s}$	Property class 5.8 [Nm]	20	39	68	173	337
	Property class 8.8 [Nm]	30	60	105	266	519
	Property class A4 [Nm]	26	52	92	232	454
	Property class 70 C [Nm]	26	52	92	232	454
<b>Concrete pryout failure</b>						
Factor in equation of CEN/TS 1992-4-5:2009 Section 6.3.3 $k_3$ [-]	2,0					
<b>Concrete edge failure</b>						
Outside diameter of anchor $d_{nom}$ [mm]	12	16	18	22	28	

**Injection system UPM 33**

**Performances**

Characteristic values of resistance for threaded rods and internal threaded anchors IST under shear loads (Design according to CEN/TS 1992-4)

**Annex C 6**

**Table C9: Displacements under tension load <sup>1)</sup> for threaded rods**

Size		M6	M8	M10	M12	M16	M20	M24	M27	M30
<b>un-cracked concrete</b>										
$\delta_{N0}$ -Factor	[mm/N/mm <sup>2</sup> ]	0,09	0,09	0,09	0,10	0,10	0,10	0,10	0,11	0,12
$\delta_{N\infty}$ -Factor	[mm/N/mm <sup>2</sup> ]	0,10	0,10	0,10	0,12	0,12	0,12	0,13	0,13	0,14
<b>Cracked concrete</b>										
$\delta_{N0}$ -Factor	[mm/N/mm <sup>2</sup> ]	--	--	0,12	0,12	0,13	0,13	--	--	--
$\delta_{N\infty}$ -Factor	[mm/N/mm <sup>2</sup> ]	--	--	0,27	0,30	0,30	0,30	--	--	--

<sup>1)</sup> Calculation of the displacement

$$\delta_{N0} = \delta_{N0}\text{-Factor} \cdot \tau$$

$$\delta_{N\infty} = \delta_{N\infty}\text{-Factor} \cdot \tau$$

**Table C10: Displacements under shear load <sup>1)</sup> for threaded rods**

Size		M6	M8	M10	M12	M16	M20	M24	M27	M30
$\delta_{V0}$ -Factor	[mm/kN]	0,11	0,11	0,11	0,10	0,10	0,09	0,09	0,08	0,07
$\delta_{V\infty}$ -Factor	[mm/kN]	0,12	0,12	0,12	0,11	0,11	0,10	0,10	0,09	0,09

<sup>1)</sup> Calculation of the displacement

$$\delta_{V0} = \delta_{V0}\text{-Factor} \cdot V$$

$$\delta_{V\infty} = \delta_{V\infty}\text{-Factor} \cdot V$$

**Table C11: Displacements under tension load <sup>1)</sup> for internal threaded anchors IST**

Size		M8	M10	M12	M16	M20
$\delta_{N0}$ -Factor	[mm/N/mm <sup>2</sup> ]	0,1	0,11	0,12	0,13	0,14
$\delta_{N\infty}$ -Factor	[mm/N/mm <sup>2</sup> ]	0,13	0,14	0,15	0,16	0,18

<sup>1)</sup> Calculation of the displacement

$$\delta_{N0} = \delta_{N0}\text{-Factor} \cdot \tau$$

$$\delta_{N\infty} = \delta_{N\infty}\text{-Factor} \cdot \tau$$

**Table C12: Displacements under shear load <sup>1)</sup> for internal threaded anchors IST**

Size		M8	M10	M12	M16	M20
$\delta_{V0}$ -Factor	[mm/kN]	0,12	0,12	0,12	0,12	0,12
$\delta_{V\infty}$ -Factor	[mm/kN]	0,14	0,14	0,14	0,14	0,14

<sup>1)</sup> Calculation of the displacement

$$\delta_{V0} = \delta_{V0}\text{-Factor} \cdot V$$

$$\delta_{V\infty} = \delta_{V\infty}\text{-Factor} \cdot V$$

**Injection system UPM 33**

**Performances**

Displacements threaded rods and internal threaded anchors IST

**Annex C 7**