



Einfach. Sicher. 

LEISTUNGSERKLÄRUNG

DoP: 0099

für Upat Nagelanker UNA (Metallanker zur Verwendung in Beton zur Befestigung von leichten Systemen) – DE

1. Eindeutiger Kenncode des Produkttyps: **DoP: 0099**
2. Verwendungszweck(e): **Für Mehrfachbefestigungen von nichttragenden Systemen in gerissenem und ungerissenem Beton. zur Verwendung in redundanten Systemen zur Befestigung und/oder Verankerung von Bauteilen z.B. leichten abgehängten Decken, sowie von Installationen am bzw. im Beton, siehe Anhang, insbesondere Anhänge B 1 bis B 2**
3. Hersteller: **Upat Vertriebs GmbH, Bebelstraße 11, 79108 Freiburg im Breisgau, Deutschland**
4. Bevollmächtigter: --
5. System(e) zur Bewertung und Überprüfung der Leistungsbeständigkeit: **2+**
6. Europäisches Bewertungsdokument: **ETAG 001; 2011-01**
Europäische Technische Bewertung: **ETA-17/0287; 2017-04-06**
Technische Bewertungsstelle: **DIBt**
Notifizierte Stelle(n): **1343 – MPA Darmstadt**

7. Erklärte Leistung(en):

Mechanische Festigkeit und Standsicherheit (BWR 1), Sicherheit bei der Nutzung (BWR 4)

- **Charakteristische Werte: Siehe Anhang, insbesondere Anhang C 1**

Brandschutz (BWR 2)

- **Brandverhalten: Der Dübel erfüllt die Anforderungen der Klasse A 1**
- **Charakteristischer Widerstand unter Brandbeanspruchung: Siehe Anhang, insbesondere Anhang C 2**

8. Angemessene Technische Dokumentation und/oder Spezifische Technische Dokumentation: ---

Die Leistung des vorstehenden Produkts entspricht der erklärten Leistung/den erklärten Leistungen. Für die Erstellung der Leistungserklärung im Einklang mit der Verordnung (EU) Nr. 305/2011 ist allein der obengenannte Hersteller verantwortlich.

Unterzeichnet für den Hersteller und im Namen des Herstellers von:

Andreas Bucher, Dipl.-Ing.

Wolfgang Hengesbach, Dipl.-Ing., Dipl.-Wirtsch.-Ing.

Tumlingen, 2017-04-13

- Diese Leistungserklärung wurde in verschiedenen Sprachversionen erstellt. Für den Fall unterschiedlicher Auslegung hat immer die englische Version Vorrang.
- Der Anhang enthält freiwillige und ergänzende Informationen in englischer Sprache. Diese gehen über die (sprachneutral angegebenen) gesetzlichen Anforderungen hinaus.

Specific Part

1 Technical description of the product

The Upat Nail Anchor UNA is an anchor made of galvanised steel, stainless steel (marking "A4") or high corrosion resistant steel (marking "C") which is pushed into a drilled hole and expanded by loading.

The product description is given in Annex A.

2 Specification of the intended use in accordance with the applicable European Assessment Document

The performances given in Section 3 are only valid if the anchor is used in compliance with the specifications and conditions given in Annex B.

The verifications and assessment methods on which this European Technical Assessment is based lead to the assumption of a working life of the anchor of at least 50 years. The indications given on the working life cannot be interpreted as a guarantee given by the producer, but are to be regarded only as a means for choosing the right products in relation to the expected economically reasonable working life of the works.

3 Performance of the product and references to the methods used for its assessment

3.1 Mechanical resistance and stability (BWR 1)

The essential characteristics regarding Mechanical resistance and stability are included under the Basic Works Requirement Safety in use.

3.2 Safety in case of fire (BWR 2)

Essential characteristic	Performance
Reaction to fire	Anchorage satisfy requirements for Class A1
Resistance to fire	See Annex C 2

3.3 Safety in use (BWR 4)

Essential characteristic	Performance
Characteristic resistance for all load directions	See Annex C 1

4 Assessment and verification of constancy of performance (AVCP) system applied, with reference to its legal base

In accordance with guideline for European technical approval ETAG 001, April 2013 used as European Assessment Document (EAD) according to Article 66 Paragraph 3 of Regulation (EU) No 305/2011 the applicable European legal act is: [97/161/EC].

The system to be applied is: 2+

Only for multiple use for non-structural applications according to ETAG 001 Part 6 Annex 1

Design types:

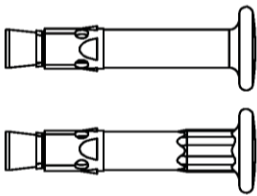
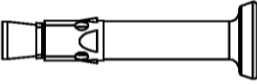
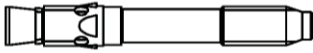
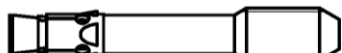
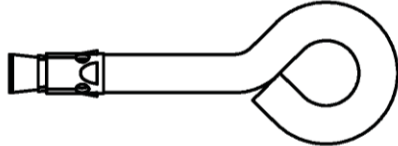
- | | | |
|--|---|----------------------------------|
| Nail head |  | UNA 6x25/..
UNA 6x30/.. |
| Nail head RB |  | UNA 6x25/.. RB
UNA 6x30/.. RB |
| Threaded bolt with ISO standard metric thread M6 |  | UNA 6x25 M6/..
UNA 6x30 M6/.. |
| Threaded bolt with ISO standard metric thread M8 |  | UNA 6x25 M8/..
UNA 6x30 M8/.. |
| UNA OE with eye |  | UNA 6x25 OE
UNA 6x30 OE |

Intended use:

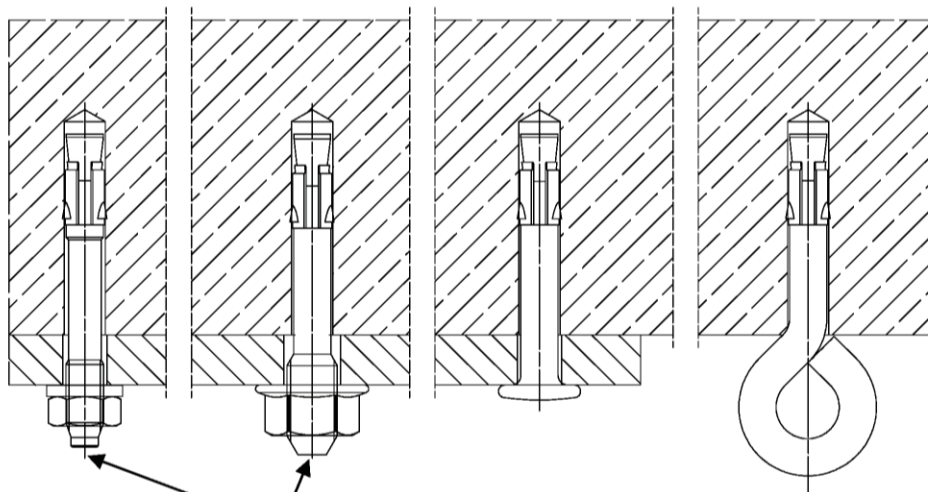

Additional marking only galvanised steel for $h_{ef} = 25$ mm (centring, bar or points)

Upat Nail Anchor UNA

Product description
Product and intended use

Annex A 1

Marking:

Nail head

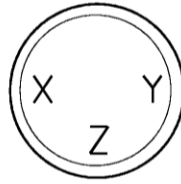

Marking at **X**: "O" for $h_{ef} = 25$ mm
and "I" for $h_{ef} = 30$ mm;

Marking at **Y**: t_{fix}

Marking at **Z**: "A4" or "C" (stainless steel)

Expansion sleeve (or bolt)

e.g.:

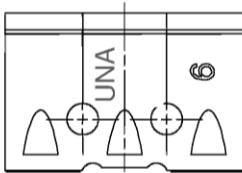

For stainless steel additional marking "A4" or "C"

Marking-Codes for Y:

	A	Q	T	N	P	B	L	H	U
t_{fix}	5	10	15	20	25	30	35	40	45

	D	V	S	W	X	E	M	Z	K
t_{fix}	50	55	60	65	70	75	80	85	90

	(A)	F	(B)	(D)	(E)	G	J
t_{fix}	95	100	105	110	115	120	125

At $t_{fix} > 125$ mm the corresponding figure is marked.

Shaft (threaded bolt)

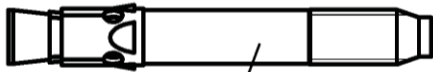

Marking e.g.: 6/10
thread size/thickness of the fixture

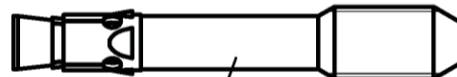

Marking e.g.: 8/10
thread size /thickness of the fixture
Exception: 8/5 no marking

Table A1: Materials

Designation	Material: Galvanized steel
Cone Bolt	Cold form steel or free cutting steel (zinc plated) Nominal steel tensile strength: $f_{uk} \leq 1000$ N/mm ²
Expansion sleeve	Cold strip, EN 10139:2013 (zinc plated)
Designation	Material: A4 (stainless steel)
Cone Bolt	Stainless steel EN 100882: 2014 Nominal steel tensile strength: $f_{uk} \leq 1000$ N/mm ²
Expansion sleeve	Stainless steel EN 10088: 2014
Designation	Material: C (high corrosion resistant steel)
Cone Bolt	High corrosion resistant steel EN 10088: 2014 Nominal steel tensile strength: $f_{uk} \leq 1000$ N/mm ²
Expansion sleeve	Stainless steel EN 10088: 2014

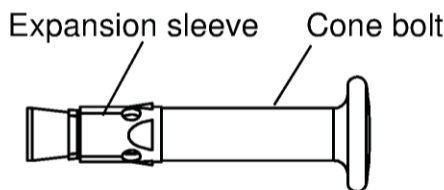

Upat Nail Anchor UNA

Product description
Marking and materials

Annex A 2

Specifications of intended use

Anchorage subject to:

- Static and quasi-static loads: All types and all embedment depths
- Fasteners are only to be used for multiple use for non-structural applications, according to ETAG 001 Part 6, Edition January 2011
- Fire exposure: only for concrete C20/25 to C50/60

Base materials:

- Reinforced and unreinforced normal weight concrete according to EN 206-1: 2000
- Strength classes C12/15 to C50/60 according to EN 206-1: 2000
- Uncracked and cracked concrete: All types and all embedment depths

Use conditions (Environmental conditions):

- Structures subject to dry internal conditions (gvz, A4, C) with $h_{ef} \geq 25$ mm
- Structures subject to permanently damp internal condition, if no other particular aggressive conditions exist (A4, C) with $h_{ef} \geq 25$ mm
- Structures subject to external atmospheric exposure including industrial and marine environment, if no particular aggressive conditions exist (A4, C) with $h_{ef} \geq 30$ mm
- Structures subject to external atmospheric exposure and to permanently damp internal condition, if other particular aggressive conditions exist (C) with $h_{ef} \geq 30$ mm

Note: Particular aggressive conditions are e.g. permanent, alternating immersion in seawater or the splash zone of seawater, chloride atmosphere of indoor swimming pools or atmosphere with extreme chemical pollution (e.g. in desulphurization plants or road tunnels where de-icing materials are used.)

Design:

- Anchorages have to be designed under the responsibility of an engineer experienced in anchorages and concrete work
- Verifiable calculation notes and drawings have to be prepared taking account of the loads to be anchored. The position of the anchor is indicated on the design drawings (e.g. position of the anchor relative to reinforcement or to supports, etc.)
- Anchorages under static or quasi-static actions have to be designed in accordance with:
 - ETAG 001, Annex C, design method C, Edition August 2010 or
 - CEN/TS 1992-4: 2009, design method C
- Anchorages under fire exposure have to be designed in accordance with:
 - EOTA Technical Report TR 020, Edition May 2004
 - CEN/TS 1992-4: 2009
 - It must be ensured that local spalling of the concrete cover does not occur

Installation:

- Anchor installation carried out by appropriately qualified personnel and under the supervision of the person responsible for technical matters of the site
- Create drill hole with hammer drill and clean the hole
- Anchor installation such that the effective anchorage depth is complied with. This compliance is ensured, if the admissible thickness of the fixture is kept. For the anchor type UNA 6 x h_{ef} OE the loop has to sit direct at the concrete surface.
- In case of aborted hole: New hole must be drilled at a minimum distance of twice the depth of the aborted hole or closer, if the hole is filled with a high strength mortar and only if the hole is not in the direction of the oblique tensile or shear load

Upat Nail Anchor UNA	Annex B 1
Intended Use Specifications	

Table B1: Installation parameters

Effective embedment depth	$h_{ef} \geq$	[mm]	25	30
Nominal drill bit diameter	d_0	[mm]	6	
Cutting diameter of drill bit	$d_{cut} \leq$	[mm]	6,4	
Depth of drill hole	$h_0 \geq$	[mm]	31	36
Diameter of clearance hole in the fixture for all UNA except for M8 and OE	$d_f \leq$	[mm]	7	
Diameter of clearance hole in the fixture for M8	$d_f \leq$	[mm]	9	
Maximum torque moment (only threaded types)	max. T_{inst}	[Nm]	4	
Minimum thickness of member	h_{min}	[mm]	80	
Maximum thickness of fixture	max. t_{fix}	[mm]	400	

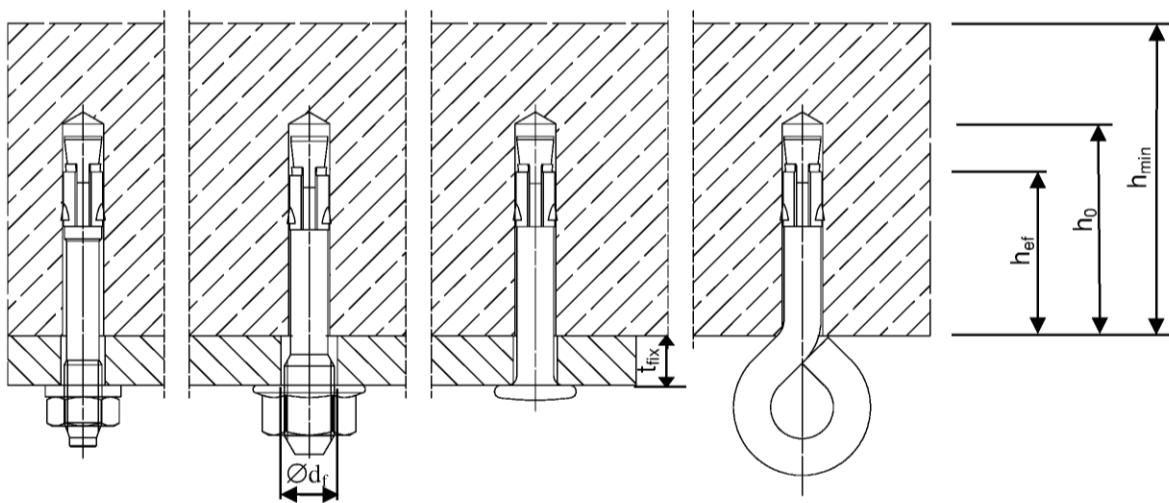

Installation instruction:

Push through installation

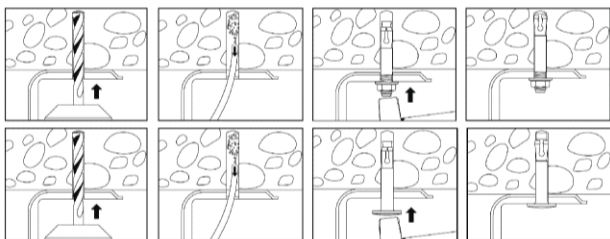

Pre-positioned installation

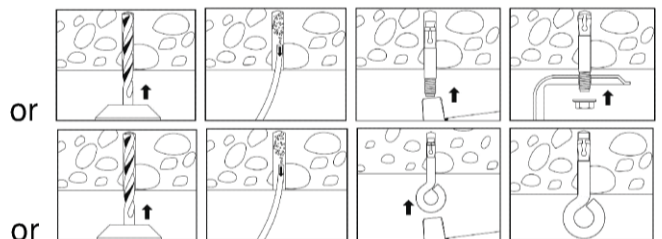

Upat Nail Anchor UNA

Intended Use
Installation parameters

Annex B 2

Table C1: Characteristic resistance of a fixing point¹⁾ for all load directions

Type of anchor		UNA 6x25/..	UNA 6x25 M6/.. UNA 6x25 M8/..	UNA 6x25 OE	UNA 6x30 OE	UNA 6x30/..	UNA 6x30 M6/.. UNA 6x30 M8/..
Material		galv.			galv., A4, C		
Effective anchorage depth	$h_{ef} \geq$ [mm]	25			30 ⁴⁾		
Installation safety factor	γ_2 [-]	1,0					
Characteristic bending moment	$M_{Rk,s}^0$ ³⁾ [Nm]	10,7	9,2		13,2	9,2	
Partial safety factor	γ_{Ms} [-]	1,25					
Maximum load for normal spacing - and edge distances							
Characteristic spacing between fixing points ¹⁾	$s_{cr} \geq$ [mm]	200					
Minimum spacing within a fixing point ¹⁾	$s_{min} \geq$ [mm]	50					
Characteristic resistance F_{Rk} C20/25 to C50/60 (C12/15)	$c_{cr}^{2)} \geq 100$	[kN]	3,0 (2,5)		1,5	5,0 (4,0)	
	$c_{cr}^{2)} \geq 50$		2,35 (1,9)			2,35 (1,9)	
Reduced loads for reduced spacing - and corresponding edge distances							
Characteristic spacing between fixing points ¹⁾	$s_{cr} \geq$ [mm]	100					
Minimum spacing within a fixing point ¹⁾	$s_{min} \geq$ [mm]	50					
Characteristic resistance F_{Rk} C20/25 to C50/60 (C12/15)	$c_{cr}^{2)} \geq 200$	[kN]	3,0 (2,5)		1,5	5,0 (4,0)	
	$c_{cr}^{2)} \geq 50$		1,7 (1,2)			1,5 (1,2) 1,7 (1,2)	
Reduced loads for minimum spacing - and edge distance							
Characteristic spacing between fixing points ¹⁾	$s_{cr} \geq$ [mm]	100					
Minimum spacing within a fixing point ¹⁾	$s_{min} \geq$ [mm]	40					
Characteristic resistance F_{Rk} C20/25 to C50/60 (C12/15)	$c_{cr} \geq 40$ [kN]	1,30 (0,85)					

¹⁾ A fixing point is defined as a single anchor or a group of 2 or 4 anchors

²⁾ Intermediate values for c may be calculated by linear interpolation

³⁾ Characteristic bending moment $M_{Rk,s}^0$ according equation (5.5), ETAG 001, Annex C

⁴⁾ Exception see B1 – use conditions – point 2

Upat Nail Anchor UNA

Performances
Characteristic resistance

Annex C 1

Table C2: Characteristic resistance under fire exposure in concrete C20/25 to C50/60

Fire resistance class for all load directions for $h_{ef} = 25$ mm							
Type of anchor	Spacing	Edge distance	Effective anchorage depth	Characteristic resistance $F_{Rk,fi}$ [kN]			
				R 30	R 60	R 90	R 120
	$s_{cr,fi} \geq$ [mm]	$c_{cr,fi} \geq$ [mm]	$h_{ef} \geq$ [mm]				
UNA 6x25/..galv.	100	50	25	0,6	0,6	0,5	0,3
UNA 6x25 M6/.. galv. UNA 6x25 M8/.. galv.					0,35	0,3	
UNA 6x25 OE galv.				0,3	0,2	0,1	

Fire resistance class for all load directions for $h_{ef} = 30$ mm							
Type of anchor	Spacing	Edge distance	Effective anchorage depth	Characteristic resistance $F_{Rk,fi}$ [kN]			
				R 30	R 60	R 90	R 120
	$s_{cr,fi} \geq$ [mm]	$c_{cr,fi} \geq$ [mm]	$h_{ef} \geq$ [mm]				
UNA 6x30/..galv.	120	60	30	0,9	0,8	0,5	0,3
	100	50			0,6		
UNA 6x30 M6/.. galv. UNA 6x30 M8/.. galv.	120	60		0,6	0,35	0,3	
	100	50					
UNA 6x30/..A4/C	120	60		0,9		0,7	
	100	50		0,6		0,5	
UNA 6x30 M6/..A4/C UNA 6x30 M8/..A4/C	120	60		0,9		0,7	
	100	50		0,6		0,5	
UNA 6x30 OE A4/C	100	50	0,3	0,2		0,1	

Fire resistance class for all load directions for $h_{ef} = 30+5^{1)}$ mm							
Type of anchor	Spacing	Edge distance	Effective anchorage depth	Characteristic resistance $F_{Rk,fi}$ [kN]			
				R 30	R 60	R 90	R 120
	$s_{cr,fi} \geq$ [mm]	$c_{cr,fi} \geq$ [mm]	$h_{ef} \geq$ [mm]				
UNA 6x30/..A4/C UNA 6x30 M6/..A4/C UNA 6x30 M8/..A4/C	140	70	$30+5^{1)}$	1,3		1,0	0,7
	100	50		0,7		0,6	

¹⁾ The effective anchorage depth $h_{ef} = 30 + 5$ mm is reached by setting the anchor UNA 6x30/... 5 mm deeper with an anchor that is 5 mm longer than required for the actual thickness of the fixture.

In case of fire attack from more than one side, the edge distance shall be ≥ 300 mm

Upat Nail Anchor UNA	Annex C 2
Performances Characteristic resistance under fire exposure	